

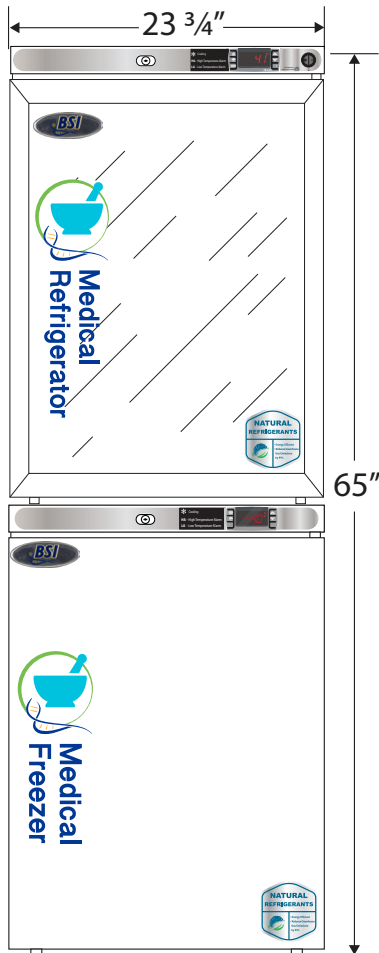

Exterior PH-BSI-HC-RFC1040G

CUTSHEET

Front View



Side View

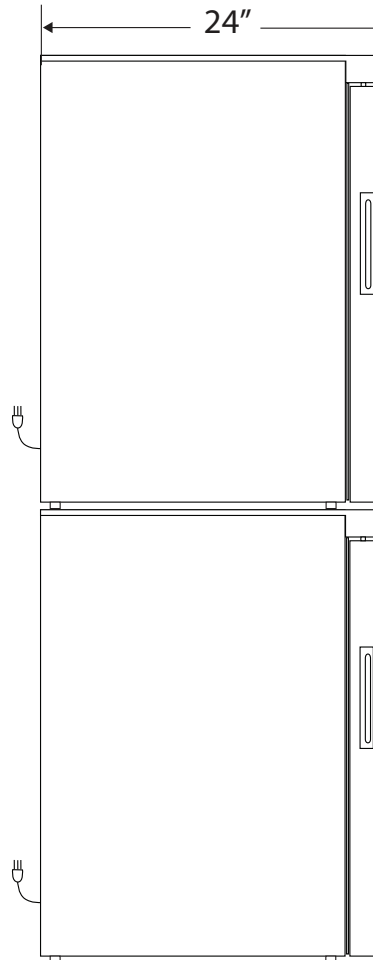

Top View

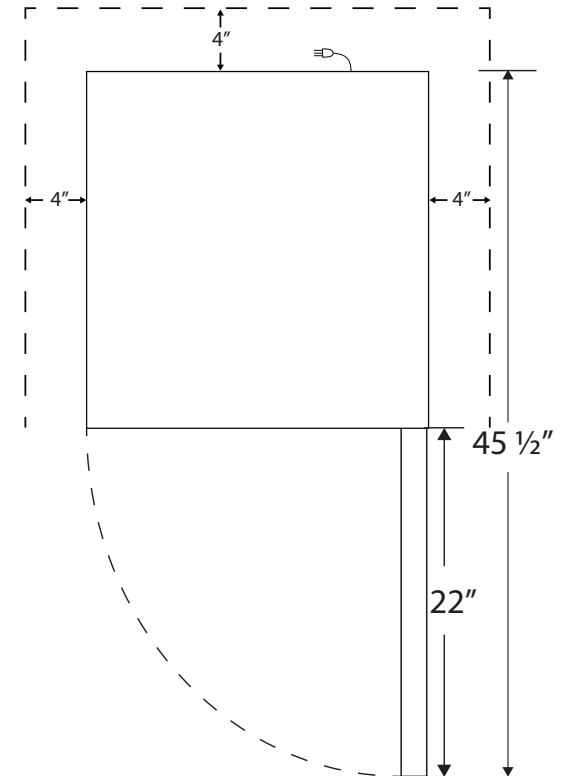

115VAC/60Hz/1PH
NEMA-5-15P

NOTE: Ventilation Requirements – Minimum 4" clearance on sides and back

Compartment	Cu. Ft	Defrost	Door	Int Door	Shelves	W"	D"	H"	Refrigerant	H.P.	Amps	Weight
Refrigerator	5.2	Cycle	1 Glass	0	3 Adj.	23 3/4	24	65	R600a	1/6	1.3	188 lbs.
Freezer	4	Manual	1 Solid	0	3 Adj.	23 3/4	24	R290	1/4	2.2		