



Interior BSI-HC-CP-72-TS

CUTSHEET

Front View

Side View

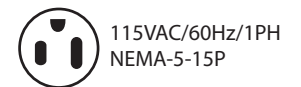
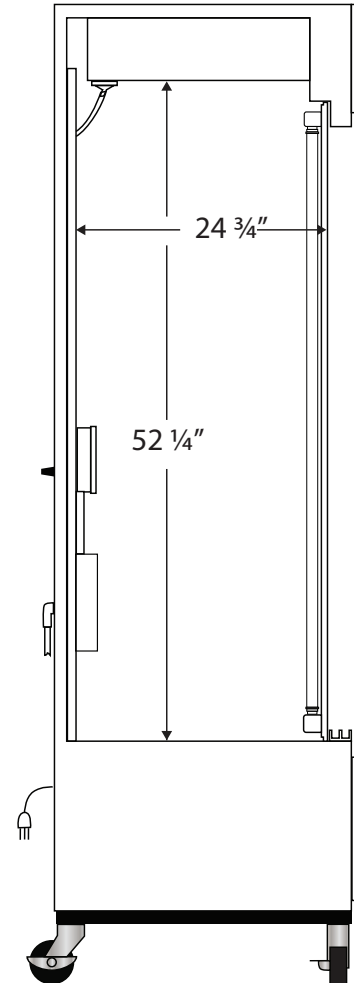
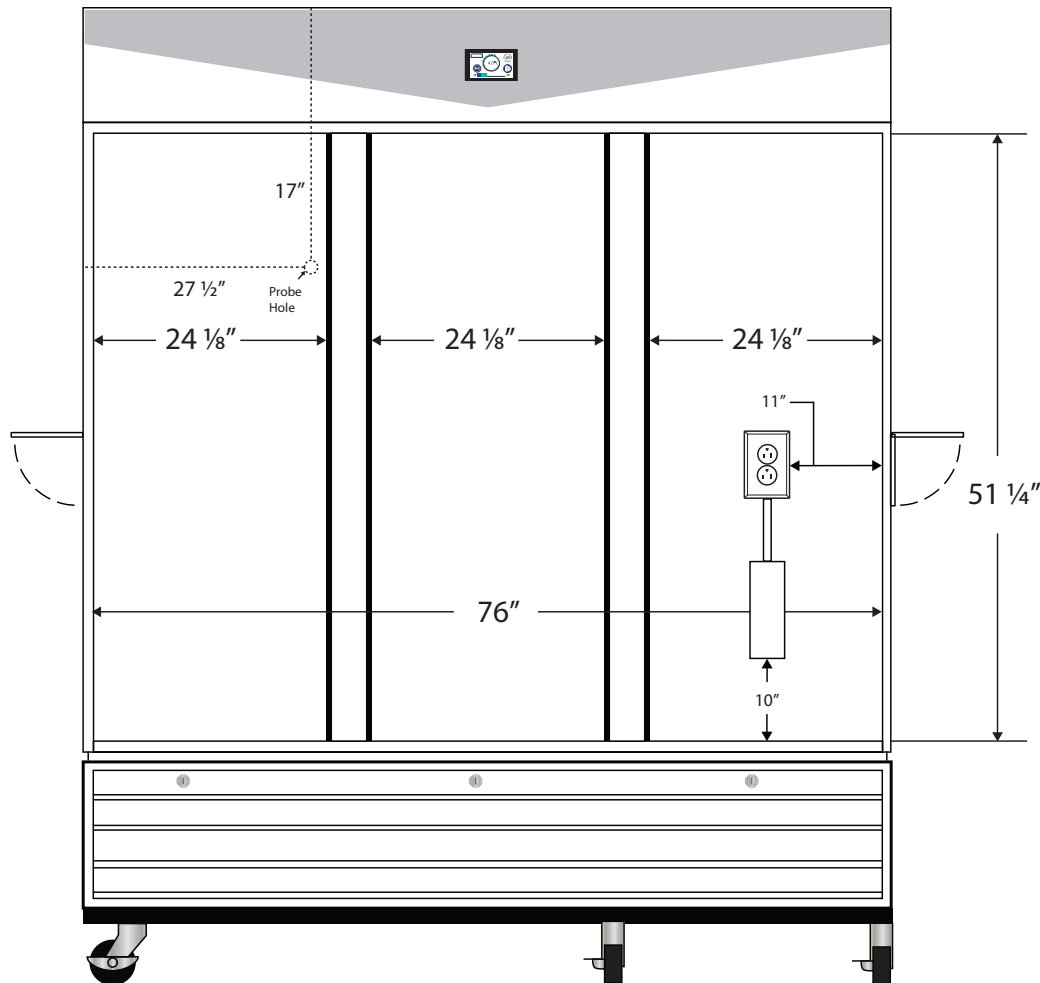

Cu. Ft	Defrost	Door	Int Door	Shelves	Interior Dim.			Refrigerant	H.P.	Amps	Weight
					W"	D"	H"				
72	Cycle	3 Glass	0	12 Adj	76	24 3/4	52 1/4	R290	1/2	7.5	693 lbs.

Note: Interior dimensions are estimates and subject to change without notice