



Caron Products & Services
OPERATIONS MANUAL



PHOTOSTABILITY CHAMBERS

Models: 7540-11 / 7545-11

Dear Valued Customer:

Thank you for purchasing CARON Products & Services equipment. We appreciate your business and look forward to being your preferred supplier of controlled environment equipment products in the future.

At CARON, we are committed to continuous quality improvement. Our goal is to supply our customers with highly reliable equipment at a fair price. In order to openly monitor our performance, we would appreciate your feedback on our products and services.

If you have questions, or any suggestions for improvement based on the installation or operation of the equipment you have purchased, please contact our service department at www.caronproducts.com or 740-373-6809.

Thanks again for your business!

Revision Log

Version	Date	Description
Rev A	10-17-17	Initial Release
Rev B	02-08-18	Removed Humidity Low Limit Alarm for a Non-Humidified Unit. ECN3973
Rev C	02-13-18	Changed chamber drain tubing interface.
Rev D	04-04-18	Edited troubleshooting section, port stoppers
Rev E	05-18-18	Updated Specs
Rev F	07-17-18	Updated PM Kit info
Rev G	05-14-19	Added analog output adjustable temperature range feature.
Rev H	11-18-19	Updated for flammable refrigerant
Rev I	01-21-21	Added adjustable alarm delay
Rev J	03-26-21	Changed warranty to 2 years
Rev K	03-31-21	Added CE Declaration of Conformity documentation
Rev L	04-13-21	Updated Declaration of Conformity documentation
Rev M	11-12-21	Updated Light Intensities Specifications
Rev N	11-12-21	Updated PM Kit list & Spare/Replacement Parts
Rev O	12-30-21	Added UKCA Declaration of Conformity

TABLE OF CONTENTS

Warranty	6
Equipment Overview	10
Installation.....	12
Unpacking	
Choosing a Location	
Preliminary Cleaning	
Installing the Port Stopper	
Installing Lamps and Light Banks	
Installing the Shelves	
Leveling the Unit	
Connecting the Drain Line	
Connecting the Water Supply (Model 7545 only)	
Connecting Electrical Power	
Optional Accessory Installation	21
Connecting Alarm Contacts (ALRM302)	
Installing the Carboy Water System (BOTL302)	
Connecting Analog Outputs (OUTP305 / OUTP306)	
Installing the Side Mounted Recorders (RCDR203 / RCDR204)	
Operation.....	26
Using the Keypad	
Learning the Touch Screen	
Changing the Temperature Setpoint	
Changing the Humidity Setpoint	
Configuring Light Tests	
Trend Graph	
Optional Accessory Operation	40
Operation of the Data Logging System (DLOG301)	
Operation of the 12" Side Mounted Recorders (RCDR203 / RCDR204)	
Calibration	46
Calibrating the Temperature	
Calibrating the Humidity	
Calibrating UVA and VIS Light Detectors	
Calibrating Optional Chart Recorders	

Alarms	49
Alarm System Overview	
Snoozing the Speaker	
Muting the Speaker	
Changing Alarm Setpoints and Delay	
Alerts	58
Alert System Overview	
Maintenance	
Advanced Features.....	62
Setting the time & day	
Setting the Humidity Control	
Setting the Door Light	
Locking the controls	
Factory menu & troubleshooting	
Preventative Maintenance.....	75
Specifications	77
Electrical Schematics	78
Troubleshooting	85
Spare Replacement Parts.....	86
Light Intensity Characteristics.....	88
Declaration of Conformity.....	91

WARRANTY INFORMATION

EQUIPMENT LIMITED WARRANTY

Please review this section before requesting warranty service. At CARON, one of our primary goals is to provide customers with high levels of personal service and top quality products, delivered on time, backed by technical service and supported for the life of the product.

Before contacting us for warranty service, please be aware that there are repairs that are not covered under warranty.

WARRANTY DEFINED

Caron Products & Services, Inc. (herein after CARON) hereby warrants that equipment manufactured by CARON is free from defects in materials and workmanship when the equipment is used under normal operating conditions in accordance with the instructions provided by CARON.

COVERED:

- Parts and labor for a period of two (2) year from date of shipment.
- Any part found defective will be either repaired or replaced at CARON's discretion, free of charge, by CARON in Marietta, OH. Parts that are replaced will become the property of CARON.
- If CARON factory service personnel determine that the customer's unit requires further service CARON may, at its sole discretion, provide a service technician to correct the problem, or require the return of the equipment to the factory or authorized service depot.
- CARON will have the right to inspect the equipment and determine the repairs or replacement parts necessary. The customer will be notified, within a reasonable time after inspection, of any costs incurred that are not covered by this warranty prior to initiation of any such repairs.

NOT COVERED:

- Calibration of control parameters.
- Improper installation; including electrical service, gas and water supply tubing, gas supplies, room ventilation, unit leveling, facility structural inadequacies or ambient conditions that are out of specification.
- Cost of express shipment of equipment or parts.
- Any customer modifications of this equipment, or any repairs undertaken without the prior written consent of CARON, will render this limited warranty void.
- CARON is not responsible for consequential, incidental or special damages; whether shipping damage or damages that may occur during transfer to the customer's point of use. When the equipment is signed for at the customer's site, ownership is transferred to the customer. Any damage claims against the shipping company become the responsibility of the customer.
- Repairs necessary because of the equipment being used under other than normal operating conditions or for other than its intended use.
- Repair due to the customer's failure to follow normal maintenance instructions.
- Parts considered consumable; including: light bulbs, filters, gases, etc.
- Damage from use of improper water quality.
- Damage from chemicals or cleaning agents detrimental to equipment materials.
- Force Majeure or Acts of God.

This writing is a final and complete integration of the agreement between CARON and the customer. CARON makes no other warranties, express or implied, of merchantability, fitness for a particular purpose or otherwise, with respect to the goods sold under this agreement. This warranty cannot be altered unless CARON agrees to an alteration in writing and expressly stated herein shall be recognized to vary or modify this contract.

Ohio Law governs this warranty.

EQUIPMENT INTERNATIONAL LIMITED WARRANTY

Please review this section before requesting warranty service. At CARON, one of our primary goals is to provide customers with high levels of personal service and top quality products, delivered on time, backed by technical service and supported for the life of the product.

Before contacting your distributor for warranty service, please be aware that there are repairs that are not covered under warranty.

WARRANTY DEFINED

Caron Products & Services, Inc. (herein after CARON) hereby warrants that equipment manufactured by CARON is free from defects in materials and workmanship when the equipment is used under normal operating conditions in accordance with the instructions provided by CARON.

COVERED:

- Parts for a period of two (2) years from date of shipment.
- Any part found defective will be either repaired or replaced at CARON's or their authorized representative's discretion. Parts that are replaced will become the property of CARON.
- If CARON or their authorized representatives determine that the customer's unit requires further service, CARON or the representative may, at its sole discretion, provide a service technician to correct the problem, or require the return of the equipment to the an authorized service depot.
- CARON or their authorized representative will have the right to inspect the equipment and determine the repairs or replacement parts necessary. The customer will be notified, within a reasonable time after inspection, of any costs incurred that are not covered by this warranty prior to initiation of any such repairs.

NOT COVERED:

- Calibration of control parameters.
- Improper installation; including electrical service, gas and water supply tubing, gas supplies, room ventilation, unit leveling, facility structural inadequacies or ambient conditions that are out of specification.
- Cost of express shipment of equipment or parts.
- Any customer modifications of this equipment, or any repairs undertaken without the prior written consent of CARON, will render this limited warranty void.
- CARON and their representative are not responsible for consequential, incidental or special damages; whether shipping damage or damages that may occur during transfer to the customer's point of use. When the equipment is signed for at the customer's site, ownership is transferred to the customer. Any damage claims against the shipping company become the responsibility of the customer.
- Repairs necessary because of the equipment being used under other than normal operating conditions or for other than its intended use.
- Repair due to the customer's failure to follow normal maintenance instructions.
- Parts considered consumable; including: light bulbs, filters, gases, etc.
- Damage from use of improper water quality.
- Damage from chemicals or cleaning agents detrimental to equipment materials.
- Force Majeure or Acts of God.

This writing is a final and complete integration of the agreement between CARON and the customer. CARON makes no other warranties, express or implied, of merchantability, fitness for a particular purpose or otherwise, with respect to the goods sold under this agreement. This warranty cannot be altered unless CARON agrees to an alteration in writing and expressly stated herein shall be recognized to vary or modify this contract.

Ohio Law governs this warranty.

Caron Products & Services, Inc.
PO Box 715 · Marietta, OH 45750
740-373-6809

INTERNATIONAL SYMBOLS AND DEFINITIONS



Help



Information



Warning of hazardous area



Warning of hot surface



Warning of dangerous electric voltage



Warning of risk of fire



Earth (ground) protective conductor

WARNINGS



Local government may require proper disposal

TO LOCATE REFRIGERANT TYPE AND PRESSURES, SEE SERIAL LABEL LOCATED ON THE OUTSIDE OF THE UNIT

FOR HYDROCARBON (R290 PROPANE) REFRIGERANT UNITS

R290 is highly flammable and must be treated with proper care.



Do not damage the refrigeration circuit. Do not store explosive substances in the unit. Component parts shall be replaced with like components and servicing shall be done by authorized personnel to reduce the risk of possible ignition.



DANGER – Flammable Refrigerant Used. Risk of fire or explosion.

- Do not puncture refrigerant tubing
- Do not use mechanical devices to defrost refrigeration equipment
- Unit to be repaired only by trained service personnel



CAUTION – Flammable Refrigerant Used. Risk of fire or explosion.

- Consult repair manual, owners guide before attempting to service this product. All safety instructions must be followed.
- Dispose of properly in accordance with federal or local regulations.



CAUTION – Do not use any electrical appliance within the Environmental Chamber, other than those recommended by the manufacturer.

EQUIPMENT OVERVIEW

Congratulations! You have just purchased the latest technology in Photostability Chambers. Designed specifically to meet ICH, FDA EMEA, and Health Canada requirements for photostability testing according to ICH Q1B option II. UVA (black) and VIS (cool white) lamps provide sequential light exposure.

Before using the equipment, familiarize yourself with key components of the product and thoroughly read this manual.

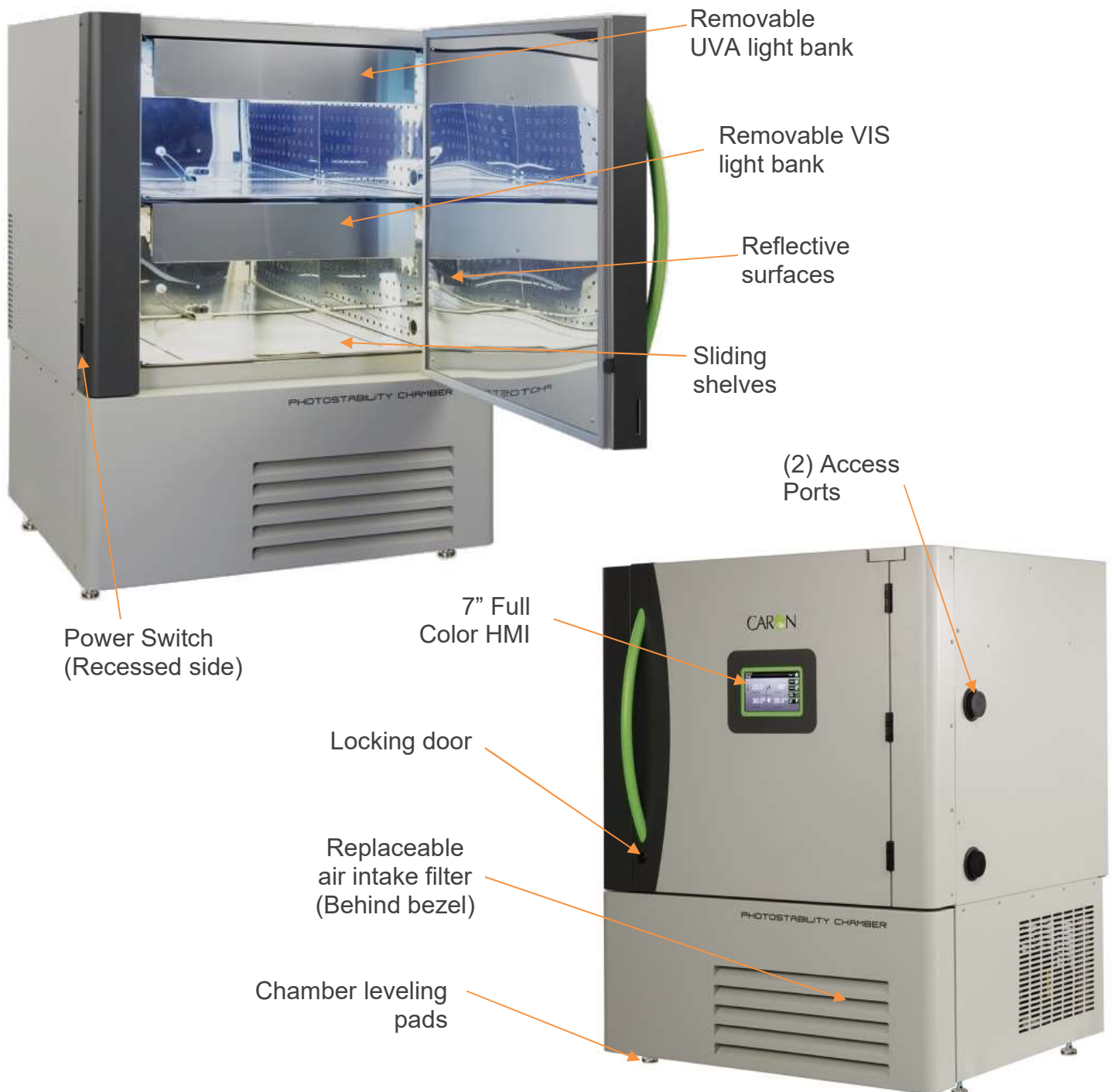

EQUIPMENT OVERVIEW – CONTINUED

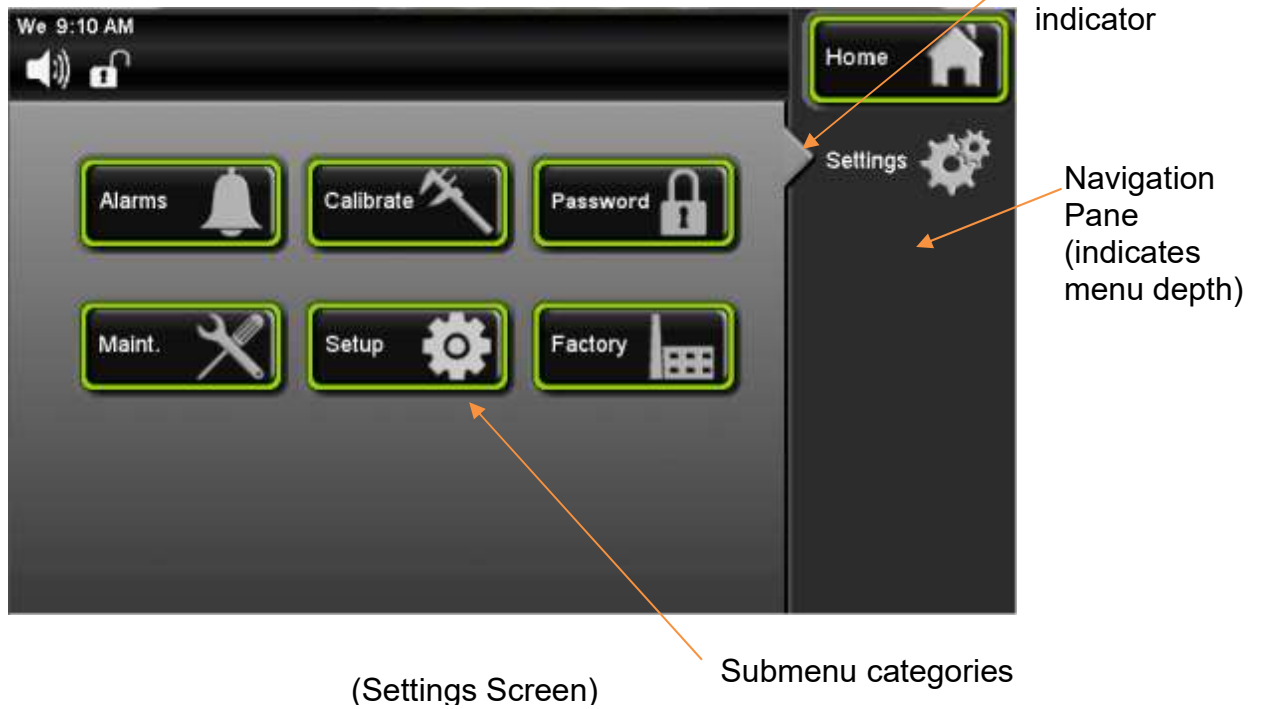
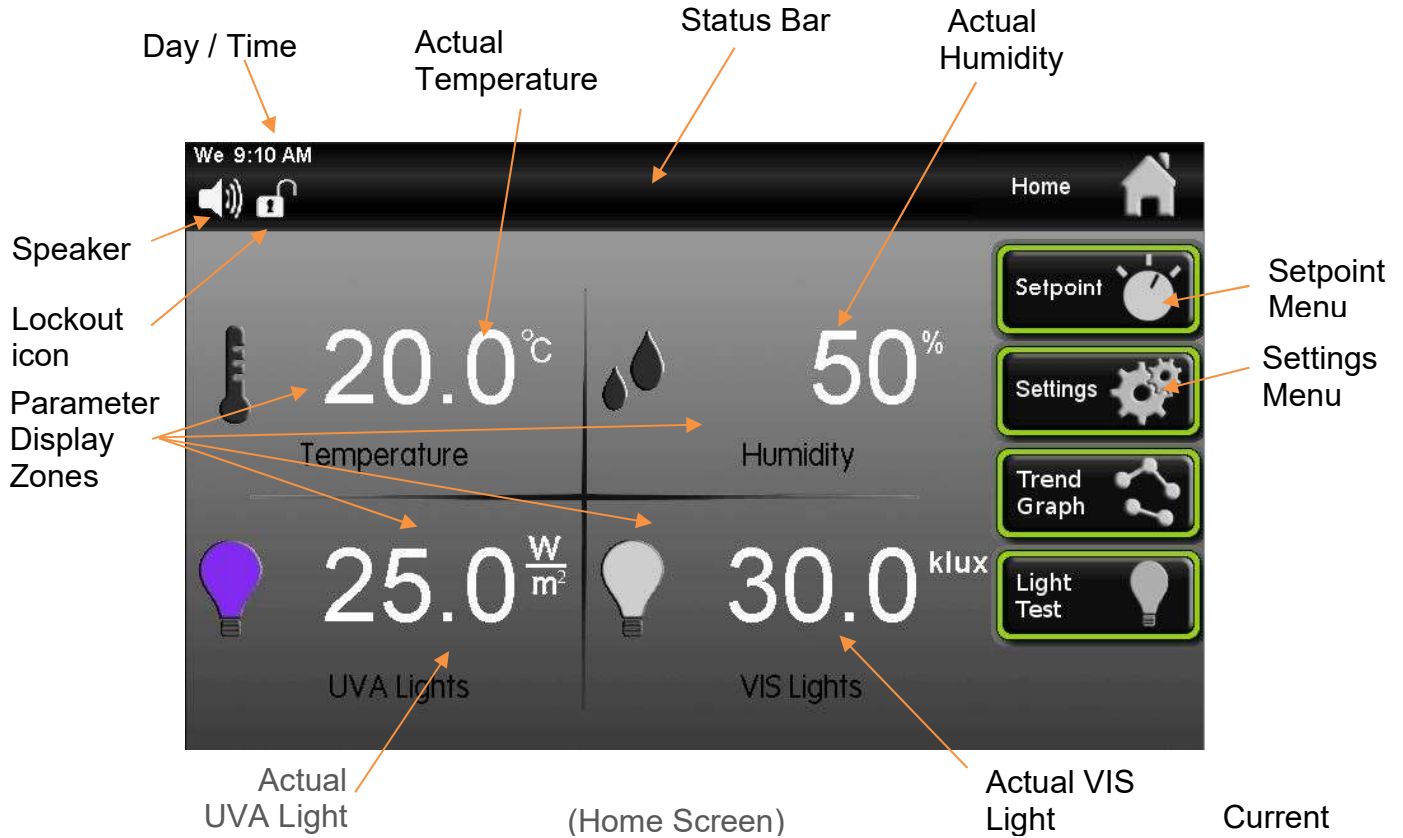

INSTALLATION

Unpacking

Your new unit has been thoroughly packaged to avoid shipping damage. However, the unit should be fully inspected upon arrival before signing for receipt. If the package has visual damage, notes should be made on the freight bill and signed by the delivery company. In the event of concealed damage after the unit is uncrated, keep the carton and packaging material. Call the shipping company within 7 days of receipt, request inspection and retain a copy of the inspection report.

For prolonged periods of inactivity leave the unit unplugged and securely stored.

Caron provides full on-site installation services for all models. Our installation services guarantees the proper set-up and startup of all equipment. Please contact the Service Department at 740-373-6809 or www.caronproducts.com for details.

For detailed instructions on how to safely remove the chamber off the shipping pallet, see document located on the chamber.

Choosing a Location



This product weighs in excess of 450 lbs. (204 kg). Ensure that sufficient resources are available to safely move the product.

To ensure proper operation, the unit must be located on a firm level surface, capable of supporting approximately 500 lbs. The unit should be located in an 18°C to 25°C ambient area and where there is no direct airflow from heating and cooling ducts as well as out of direct sunlight. Allow four inches of clearance on all sides of the product to allow for connections and airflow. The chamber can exhaust 4000 BTU/hr (1170 W) into the surroundings. The chamber operates quietly around 60 dBA at 6 ft (2 m) away. The unit is designed to be used under the following conditions.

- Indoor use only
- Altitude up to 2000m.
- Maximum relative humidity: non-condensing
- Mains supply voltage fluctuations up to +/- 10% of the nominal voltage; damage may occur if voltage varies more than 10%
- Transient overvoltage's up to the levels of overvoltage category II
- Temporary overvoltage's occurring on the mains power supply
- Pollution degree: 2
- Ingress protection: IPXO



Do not put more than 10 lbs (4.5 kg) on top of unit.

Model	Water Source Needed	Water Drain
7540	No	Yes
7545	Yes	*Yes

*Depending on user setpoints, these units may not need a drain. Drains are recommended at temperatures below 15°C.

The unit requires a dedicated electrical connection. Power requirements vary depending upon the chamber model, see Connecting Electrical Power section.

Choose a location where these facilities are, or can be made available. If a water source or a drain is not available, contact CARON customer service and ask about our CRY5102 product line or click this web link <http://www.caronproducts.com> for information on the product:

Preliminary Cleaning

Your new environmental chamber was thoroughly cleaned prior to leaving the factory. It is recommended however, to disinfect all interior surfaces with a general purpose laboratory cleaning agent prior to using the product. Contact Caron if there is any doubt of the compatibility of the cleaning agent being used with the chamber. After cleaning, dry all interior components with a non-abrasive sterile cloth as necessary.

Installing the Port Stoppers

The unit has access ports built into the right side of the cabinet. The ports are designed to allow customer access for equipment validation and for installation of other equipment inside the chamber. These ports should be sealed with the provided rubber stoppers to allow the chamber to function properly. Install the stoppers provided in the port on each side of the unit.



R290 REFRIGERANT UNITS

DANGER – Flammable Refrigerant Used. Risk of fire or explosion.

- No equipment that uses an open flame should be placed inside the unit.
- Do not use instrumentation or equipment that incorporates potential ignition sources, e.g. open contact switching, brushed DC and AC motors, etc.
- Do not use electrical appliances within the unit, other than those recommended by the manufacturer.

Installing Lamps and Light Banks

The UVA and VIS light banks are not shipped inside of the unit. The UV and VIS lamps are separate and have to be installed. There are 2 different types of lamps: Socket and Pin.



The socket type of lamp has one end of the light fixture that is a spring loaded plunger, pull back on the plunger, fit the opposite end of the lamp into the fixed socket, and align the spring loaded plunger with the opposite end of the lamp.



To insert the pin lamp align pins vertically as shown in pic, push both ends simultaneously into the lamp fixtures, rotate ¼ turn. Make sure that the pins on both ends of the lamps are all of the way in the socket before turning.



After the bulbs installed, slide light banks into the chamber. The **UVA light bank goes in the top position “C” shaped slot and the VIS light bank goes into the 3rd “C” slot** down from the top. Each light bank will make a “click” sound when it is installed correctly. If you don’t hear the “click”, then the light bank is not installed properly.

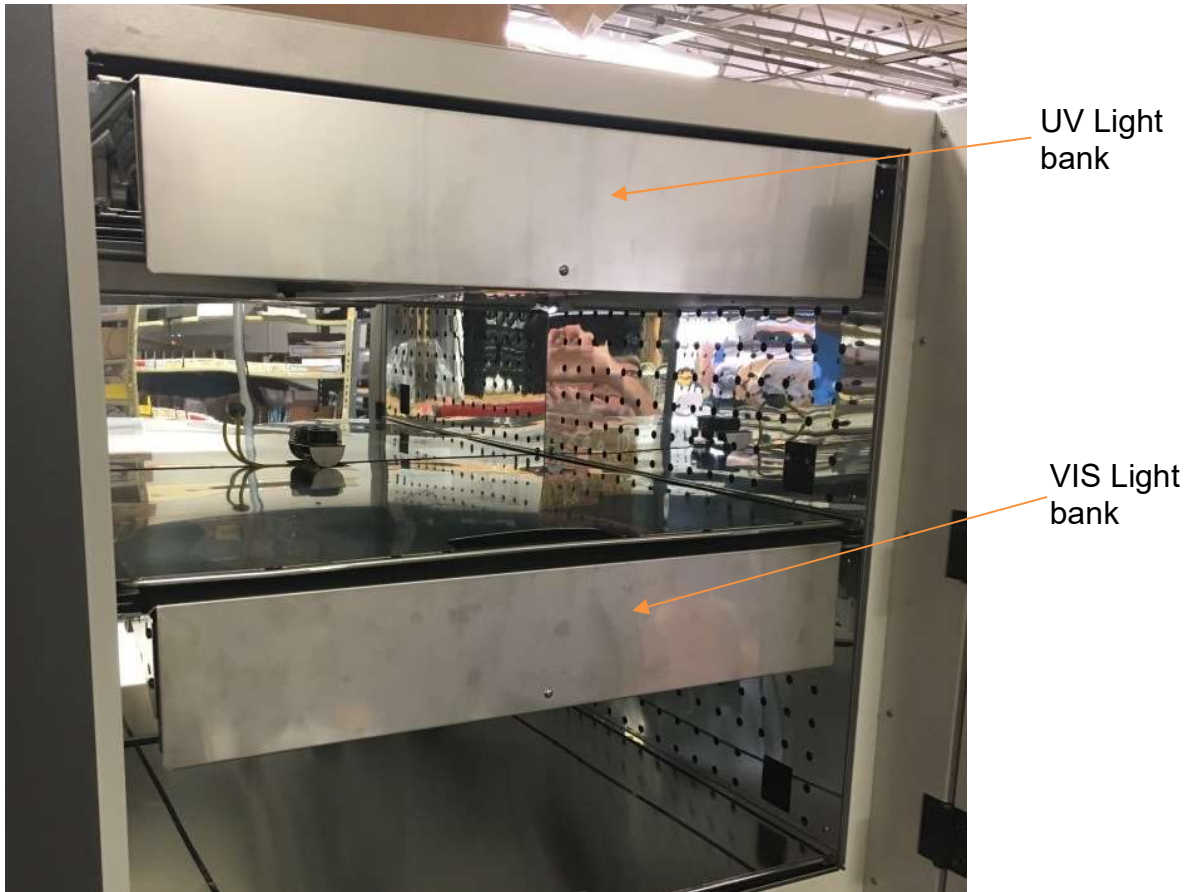

Installing the Shelves

Each new 7540-11 Series Photostability Chamber includes 2 stainless steel shelves. With the light banks installed the distance between the light banks and the shelf are a fixed value. The chamber should be empty when being moved.



Each shelf is capable of supporting a uniformly distributed load of 22 lbs (10 kg). The maximum chamber capacity (stationary) is: 44 lbs. (kg).



Do not have multiple loaded shelves out simultaneously or the chamber may tip.

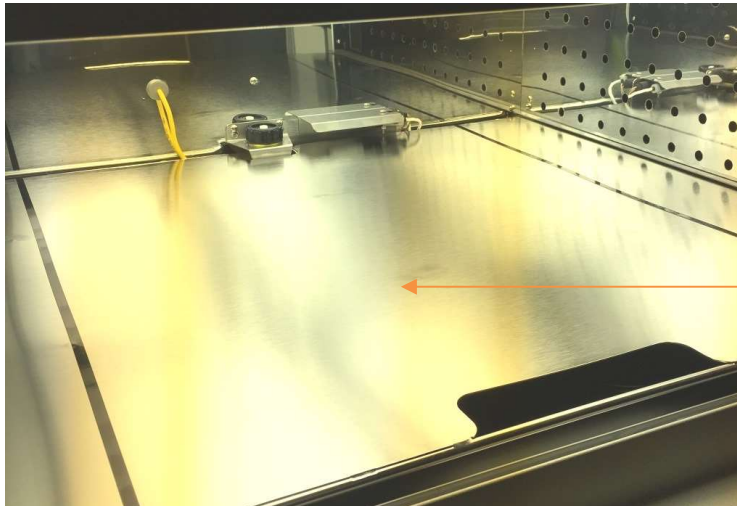

Usable shelf area
(Between black lines)

Leveling the Unit

Place a level on the middle shelf of the chamber. Adjust the feet until the unit sits level left to right and front to back. .

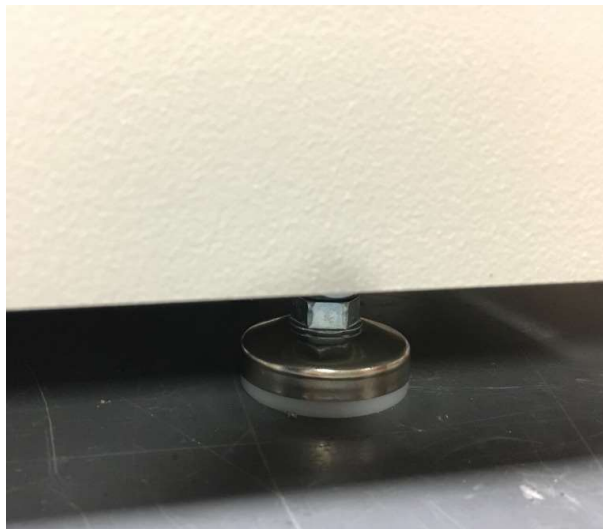

Located on the back of the chamber is the connection Interface plate this panel contains connections for power cord, water/ drains Communication, Analog Outputs etc.

Connecting the Drain Line



When using a pressurized water source, failure to connect the unit to a drain could result in facility flooding.



The chamber drain connection is located in the bottom middle of the back of the chamber. A 3/8" tube fitting, tubing and wire ties are supplied in the unit parts kit. Insert the tube fitting into the tubing, secure tubing to fitting with provided wire tie. Insert fitting into drain connection. Pull on the tubing after installation to make sure it is secure. Route the drain tubing to a local floor drain. Duplicate fitting installation on other end of tubing if necessary.



The drain line relies on gravity to remove water from the chamber. The drain line must remain below the chamber to drain properly. Kinks or elevations in the drain line above the cabinet drain will not allow the chamber to drain.

If a local floor drain is not available, a variety of accessories are available through CARON customer service. These accessories can also be viewed at www.caronproducts.com.

Connecting the Water Supply (Model 7545 only)

To ensure proper operation, distilled or deionized water is required as a supply on units that have humidity control. If these water sources are not available contact CARON customer service.



Use only distilled or deionized water with a resistivity between 50K Ω -CM and 1M Ω -CM and a pH of greater than 6.5. Using water outside this range will void your warranty.



Do not use water that contains chloramines. Chloramines can damage internal rubber gaskets resulting in leaks.

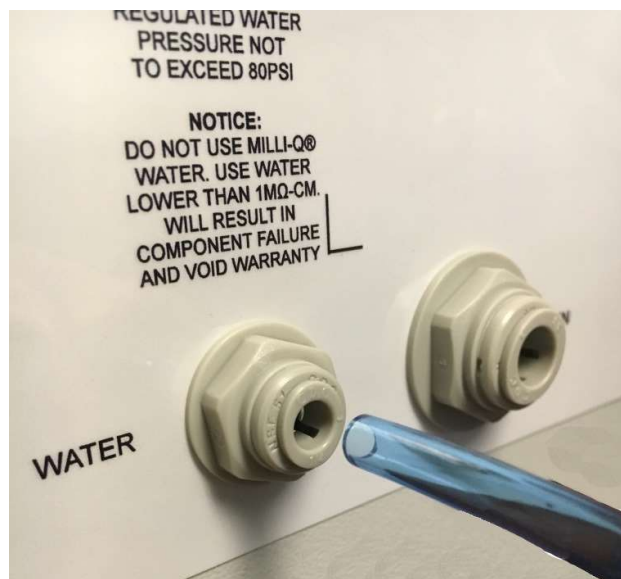

A water inlet fitting on the back of the unit and 1/4" tubing are provided to connect the water supply to the chamber. Connect an appropriate water supply to the fitting. Incoming line pressure should be regulated to not exceed 80 psi.

If a Condensate Recirculator water recycling system was purchased as a water supply, refer to its user's manual for proper installation.

Connecting Electrical Power



Connect each chamber to a grounded circuit. Failure to do so could result in electrical shock.

The unit requires a dedicated electrical outlet. See table below for model specific power required and connection.

Model #	Power Requirements	Plug Connection
-1	115V, 60Hz, 15A FLA	NEMA 5-15
-2	230V, 60Hz, 15A FLA	NEMA 6-15
-3	230V, 50Hz, 10A FLA	CEE 7/7

When the required electrical connection is available, plug the provided power cord into the unit and the electrical outlet.



The mains power supply cord must meet the requirements listed above. The use of an inadequate mains power supply cord could result in equipment failure or personal harm to the user.



In the event of a power outage the unit will automatically restart when the power is restored.

OPTIONAL ACCESSORY INSTALLATION

Connecting Alarm Contacts (ALRM302)

With the purchase of ALRM302, a set of terminals on the rear of the unit is provided to monitor temperature, UVA Lights, VIS Lights & humidity.

With the alarm contacts, the terminals provided allow for a NO (normally open) output, a NC (normally closed) and COM (common) connection. In the event of an alarm condition or power failure, the NO contact will close, and the NC contact will open. Once the alarm is cleared, the contacts return to their normal conditions. Insert the appropriate wire into the terminal and tighten down the screw terminal on top of the connector.

Terminal Connection	Unit off	Normal	Alarm
N/O to C	Closed	Open	Closed
N/C to C	Open	Close	Open

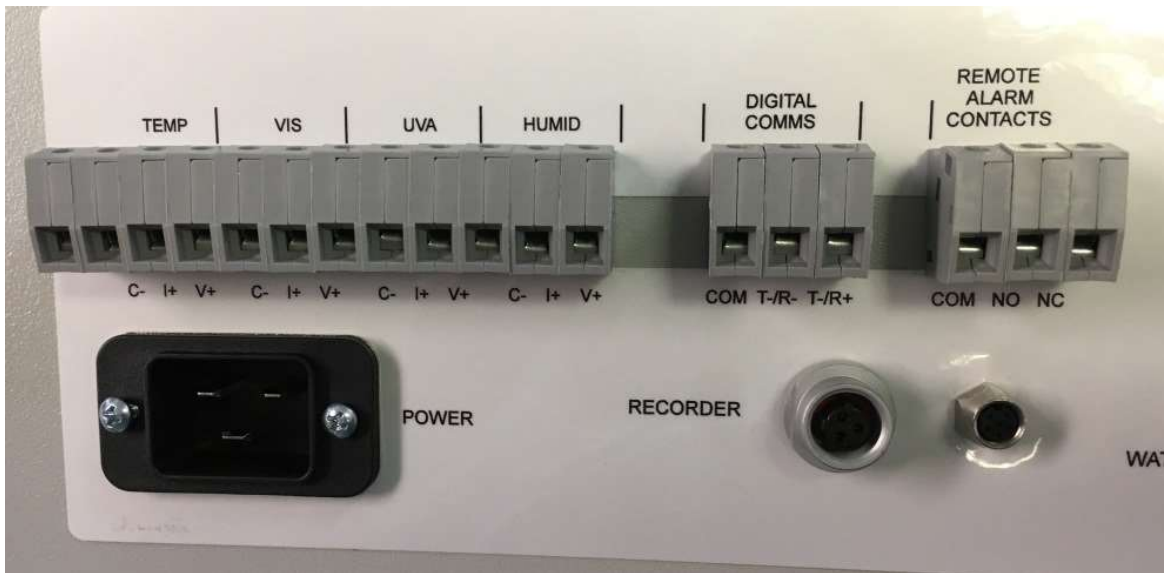

Installing Carboy Water System (BOTL302)

The optional 4 liter carboy water system is preassembled and shipped with the chamber. This carboy attaches to the right side of the Photostability chamber and provides water for units with controlled humidification.



Squeeze the flow restriction clamp, fill the carboy with water as described in the “connecting a water supply” section of the manual. Connect the preassembled tubing provided with the carboy to the water inlet on the rear of the incubator. Release flow restriction clamp.

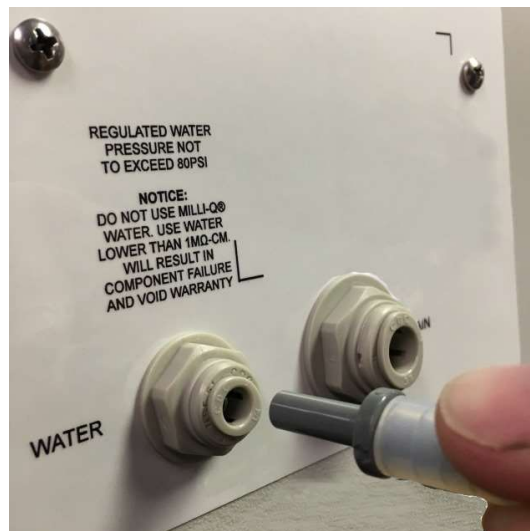

Connecting Analog Outputs (OUTP305 / OUTP306)

With the purchase of OUTP305 or OUTP306, the controls are equipped with analog outputs.

OUTP305 provides 3 connections for monitoring temperature, UVA lights, VIS lights. OUTP306 provides 4 connections for monitoring temperature, UVA lights, VIS lights, humidity.

Analog outputs provide either milliamps (4-20mA) or voltage (0-5V) signal output to represent each of the displayed temperature, UVA light, VIS light and humidity variables. These options can be used for connection to in-house data acquisition, recorder, or alarm system. The temperature parameter (only) is adjustable in its scaling and is accessible at the Analog Output screen.

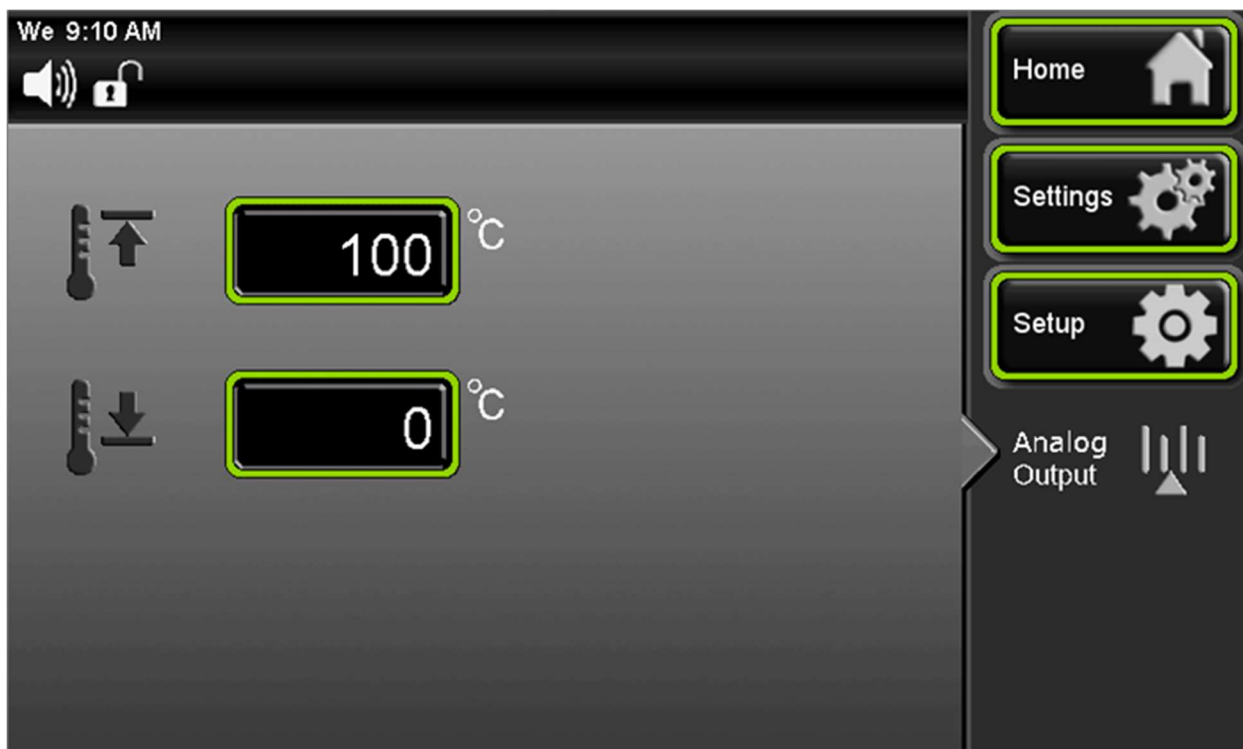

Parameter	Analog Output	Current	Corresponding Value
Temperature	0 – 5 V	4-20 mA	-50 – 100 °C (adjustable)
Humidity	0 – 5 V	4-20 mA	0 – 100 %RH
UVA light	0 – 5 V	4-20 mA	0 – 50 W/m ²
VIS light	0 – 5 V	4-20 mA	0 – 50 klux

*Default range is -50C to +100C. Temperature scale low range is adjustable from -50C to 0C. Temperature scale high range is adjustable from 1C to 100C.

Connect shielded wires to the appropriate signal terminals: I(+) for current (mA) or V(+) for voltage (DC). For both current and voltage outputs, C(-) is common terminal.

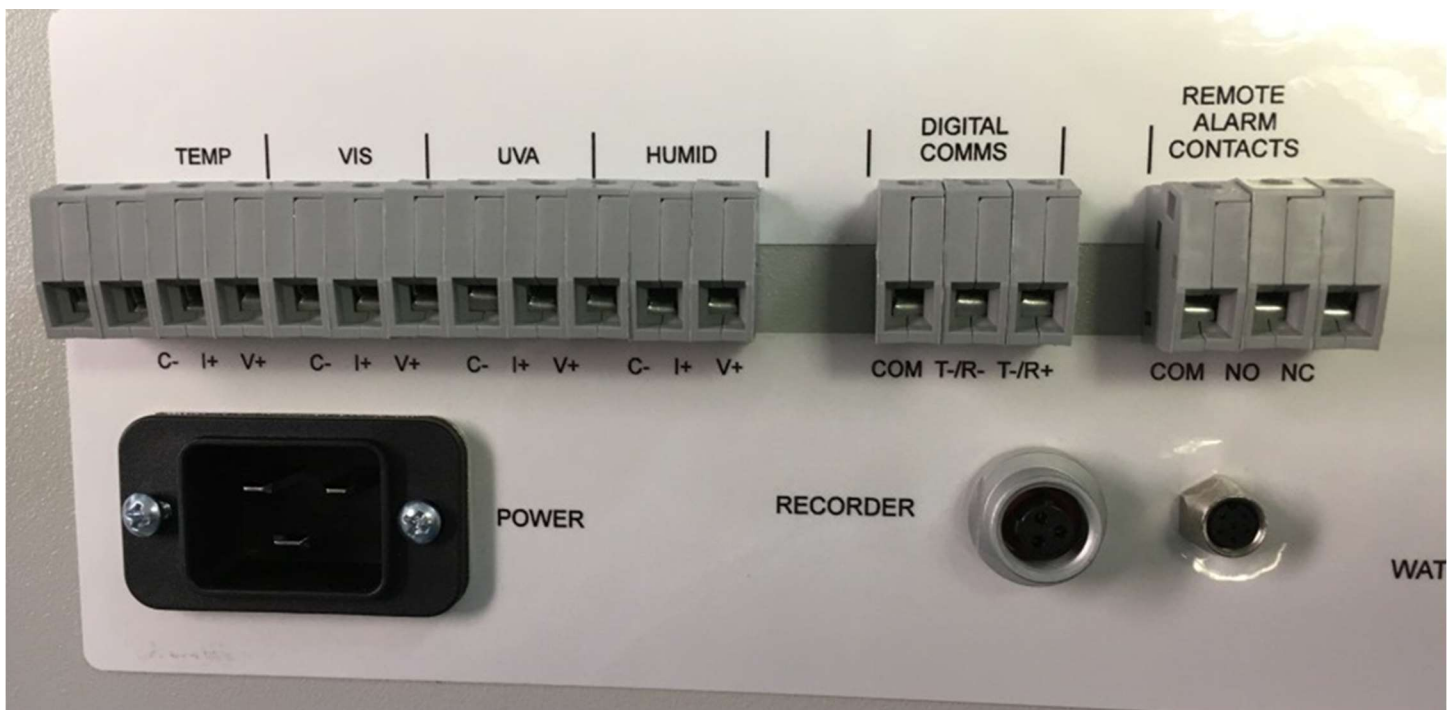

Installing Side Mounted Recorders (RCDR203 / RCDR204)

The recorder will arrive packaged on top of the chamber. Carefully remove the recorder from its packaging. Mount the recorder by using the pre-installed recorder bracket. There are three factory drilled holes located on the right side of chamber as you face the front of chamber. Using the factory supplied screws, screw the recorder to the side of the chamber.

There are two cables that come out of the recorder. One is to power the recorder; the other is to receive the temperature, humidity, UVA and VIS light signals coming from the chamber. With power to the equipment turned off, plug the two connectors into their mating connector at the top of the chamber. Turn power to the chamber back on. Standard factory set up for chart speed is 7 day operation. Refer to the Chart Recorder's User's Manual provided with the recorder to change the chart speed settings for various chart speeds.



OPERATION

Before the Photostability chamber can be commissioned for use, make sure that the following steps have been completed:

- Chamber is sitting on a table or cart.
- Lamps are installed in light banks.
- The appropriate utilities connected to the chamber.

With the above mentioned steps complete, the power switch located on the left side, near the middle of the unit exterior, can be turned on. The lights will not turn 'on' for the first minute while the sensor warms up.

Within a few minutes, the temperature and humidity will begin to approach setpoints. Here is an overview of the home screen.

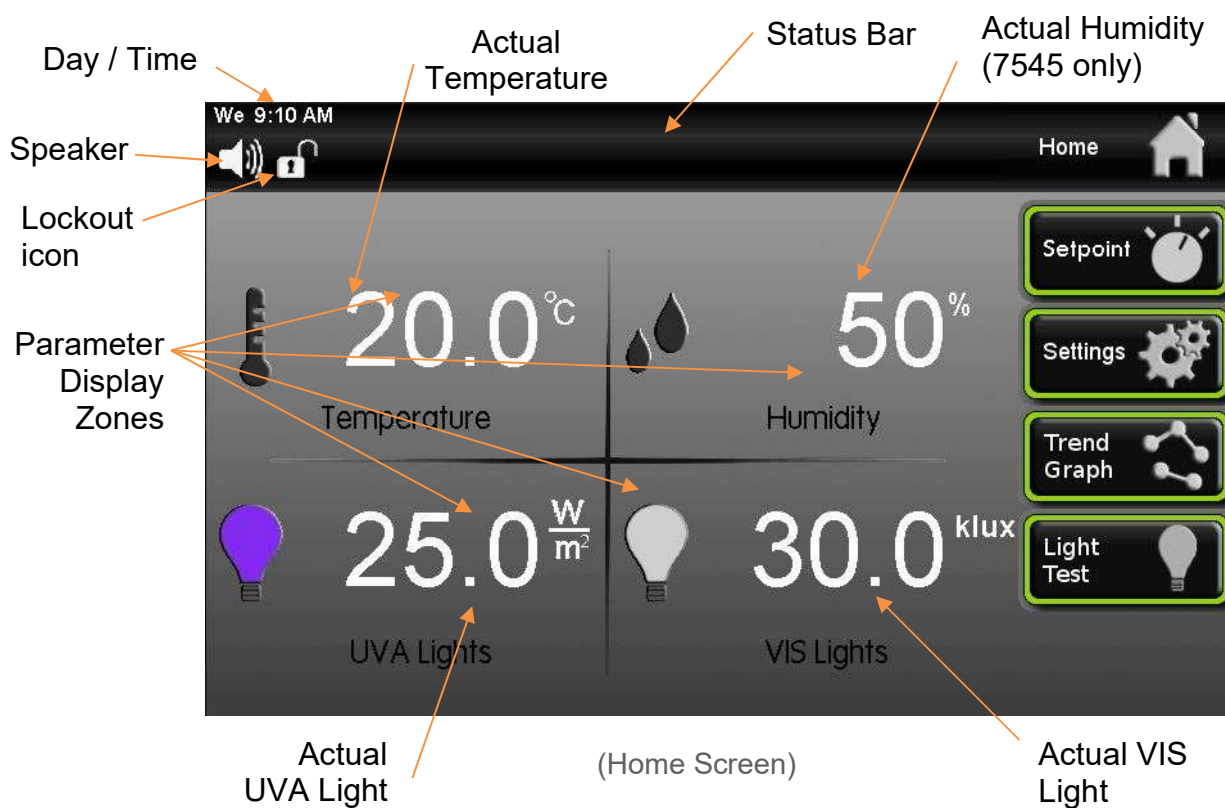

Using the Keypad

This control system uses a numeric keypad to enter all parameter values. Similar to a calculator, this allows quick and precise entry of values. When any numeric value button is pressed, the keypad display will pop up over the current display.

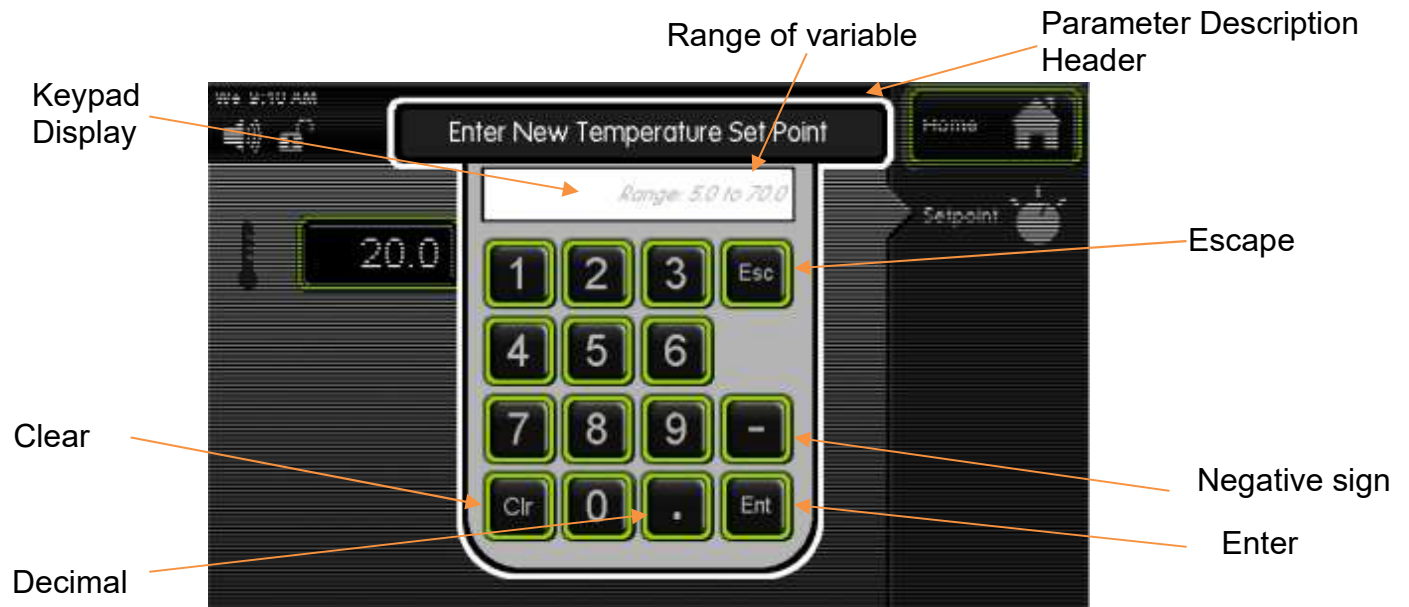

The Parameter Description Header tells what parameter is being changed. The Keypad Display shows allowable values of the parameter being changed (initially) and displays the entered value (when a button is pressed).

The Escape “Esc” button aborts the entry and returns to the previous screen without changing the value. The Clear “Clr” button erases the value that you have entered. After you have entered the value that you want, pressing the Enter “Ent” button and the new value will take affect. This also closes the keypad window. Other keypad buttons include a decimal point button and negative button.

If an invalid numeric button is pressed such that it would create an entry above the parameter’s range, the entered number will not display. For example, if the temperature setpoint range is 5.0 to 35.0, pressing ‘8’ followed by an ‘0’, only the ‘8’ will display.

If an invalid entry is made with an entry below the range (such as a ‘4’ followed by the ‘Ent’ button), then the entry will clear and the range will be re-displayed.

Learning the Touchscreen

To save power and ensure long product life, the touchscreen display has a few features that can be changed to reduce screen brightness and initiate a Screen Saver mode.



High / Low button: high or low screen brightness, preset values.

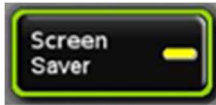



Screen Saver: By pressing the Screen Saver button “on” this will automatically enter screen saver mode after 15 minutes. At this time, the screen will be completely blank (ie. black). The illuminated Caron logo (see Equipment Overview section) shows that the unit is powered on and functioning. To wake-up the touchscreen, simply press anywhere on the touchscreen and the main screen will display. If the unit has an alarm condition, the touchscreen will not go into screen saver mode. If an alarm condition occurs while in screen saver mode, the display will automatically wake up and display the alarm.



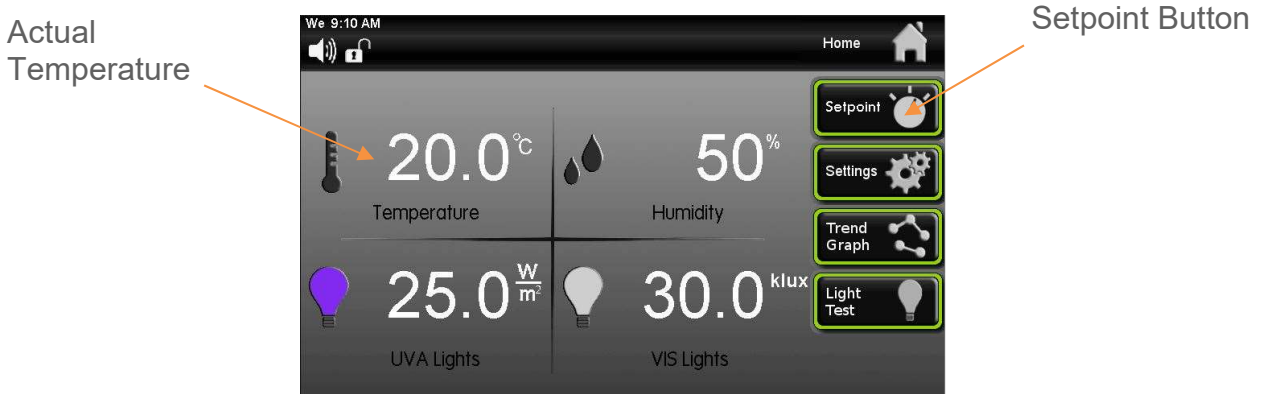

Changing the Temperature Setpoint

The steps below walk through an example of changing the temperature setpoint from 30.0 °C to 20.0 °C. This example shows humidity control as well (select models). Here is the display of the home screen.

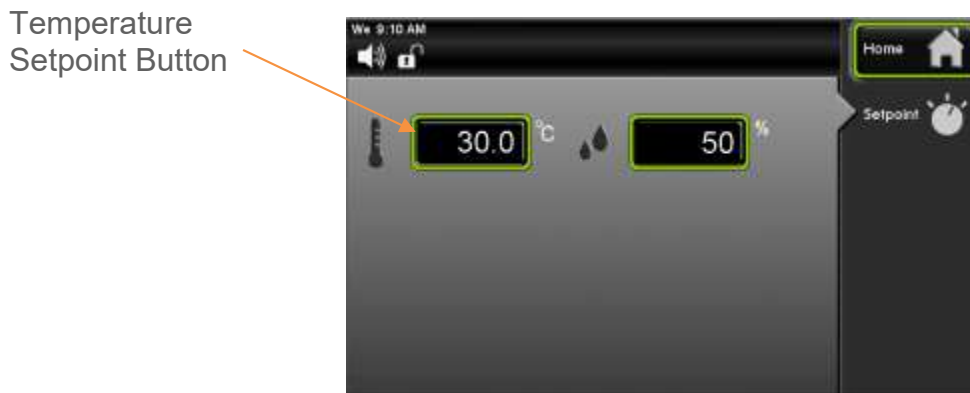

To set the temperature setpoint, press the  (Setpoint) button on the right side of the screen.



Once the Setpoint screen appears, press the  (Temperature Setpoint) button. (In this example the temperature setpoint initially has a value of '30.0'; this will vary with different initial setpoint values.)

A temperature setpoint window will appear. Enter the temperature setpoint by using the keypad. For a setpoint of 20, press '2'), then ('0'), followed by the (Ent) button. Correct any mistakes with the (Clr) and reenter the value.

Once the Enter key has been pressed, the pop-up keypad disappears and the screen returns to the Setpoint display with the new value of 20.0 in the temperature setpoint button.

Temperature Setpoint Button



Home



Press the  (Home) button to return to the main screen.

Changing the Humidity Setpoint (Model 7545)

The steps below walk through an example of changing the humidity setpoint. Here is the display of the home screen.

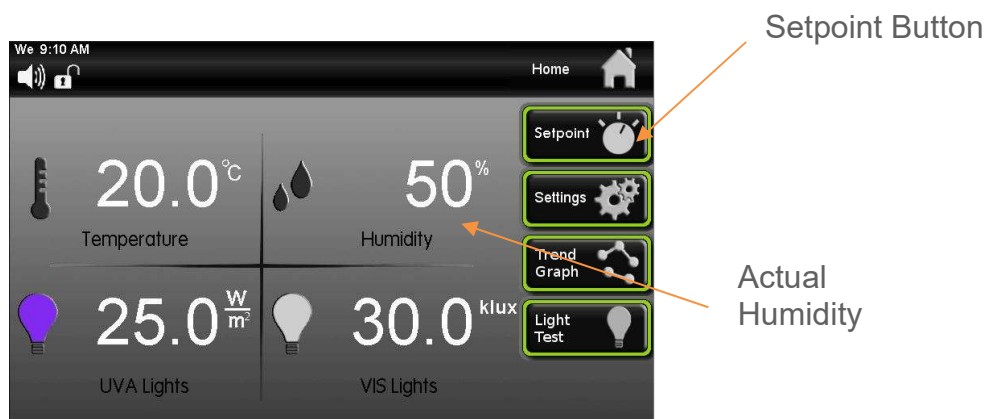

To set the humidity setpoint, press the  (Setpoint) button on the right side of the screen



Once the setpoint screen appears, press the  (Humidity Setpoint) button.

Enter the new humidity setpoint on the keypad as desired and press  (Enter) when complete.



Home Button



Press the  (Home) button to return to the main screen.

Configuring Light Tests

There are 3 different types of light control configurations. Exposure, Timed, and Continuous.

The UVA and VIS light bank can run either the same type of configuration or run 2 different configurations.

Exposure: this selection allows the light exposure to be set to a value and will maintain that value for a period of time. The amount of time is based on the exposure value entered for each type of light UVA and VIS.

The default values are for ICH guidelines are UVA: 200 W-hr/m², VIS: 1200 klux-hr

Timed: this selection allows light exposure time to be set for days, hours and minutes.

Continuous: this selection is controlled manually by the user. There are no input values. The intensity values are displayed on the home screen.

Depending on usage, the intensity values will start to degrade over time for both the UVA and VIS lamps. The lamps have a life of 2000 hrs of “on” time.

Refer to the Maintenance section of the manual to see how many hours are remaining and when you may need to order replacement lamps.

To setup a Exposure test:

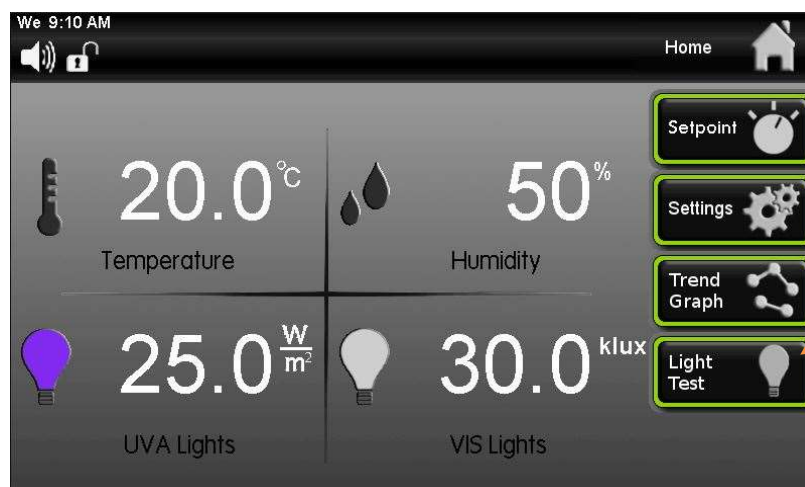

Light Test Button

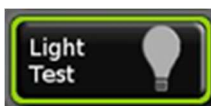

Press the  (Light Test) button.

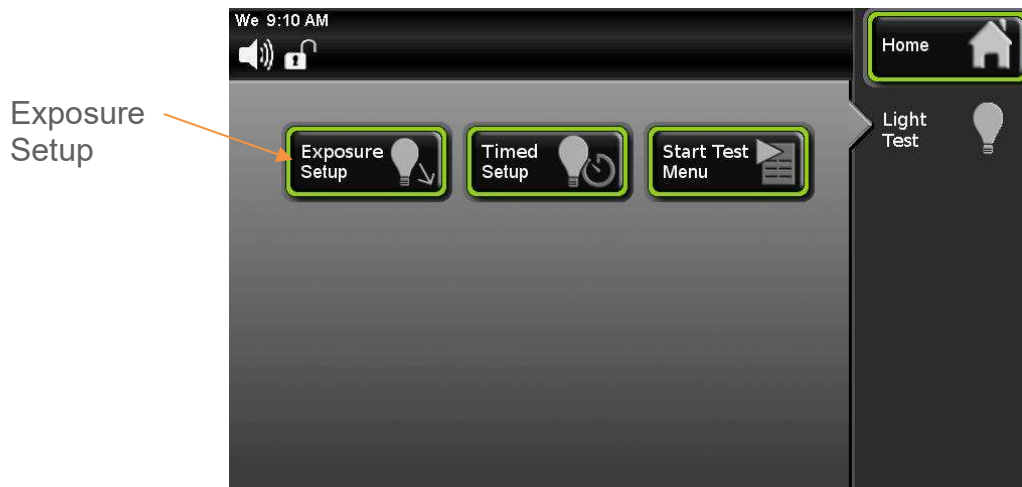

Press the  (Exposure Setup) button.

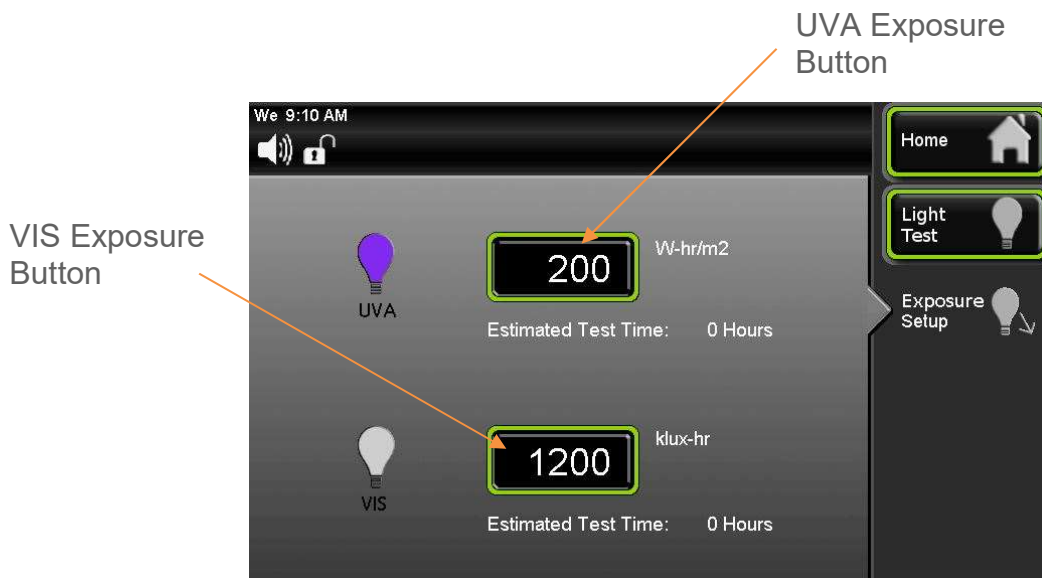

Press the UVA Exposure button, enter exposure level in the keypad, press enter when complete. Press VIS Exposure Button, enter exposure level, press enter when complete.

The default values are for ICH guidelines are UVA: 200 W-hr/m², VIS: 1200 klux-hr

Press the  (Light Test) button to return to the previous screen, then press

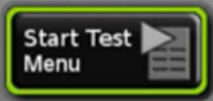
the  (Start Test Menu) button to define the type of configuration each UVA and VIS light bank will run.

To setup a Timed test:

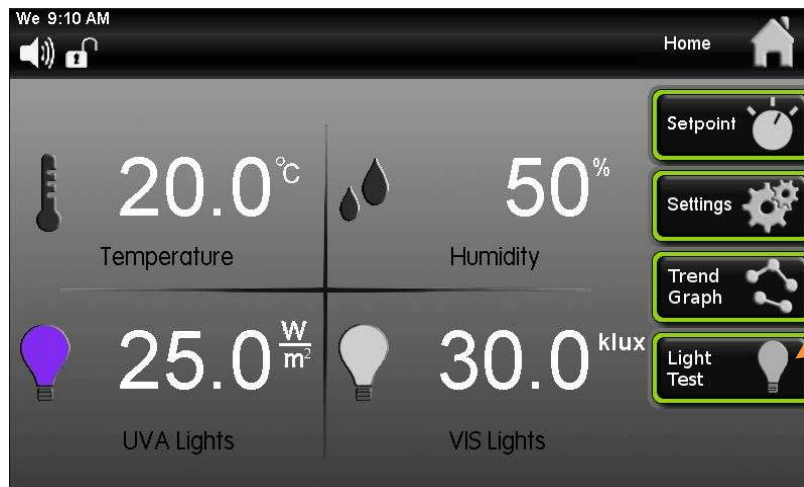

Light Test Button

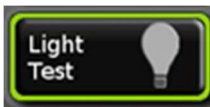

Press the (Light Test) button.

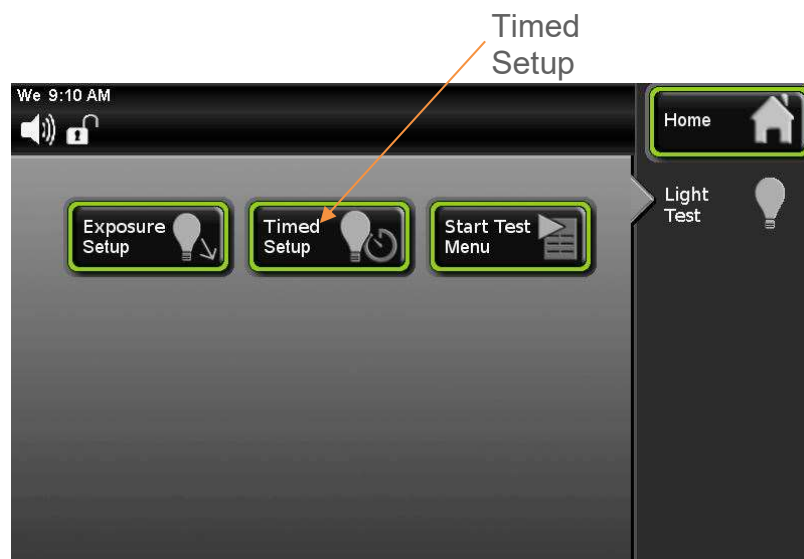

Timed Setup



Press the (Timed Setup) button.



Press the Days, Hours and Minute buttons, enter values for each if required.
Default values: Days 1, Hours 0, Minutes 0

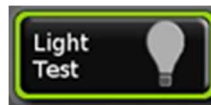

Once all values have been entered, Press the (Light Test) button to

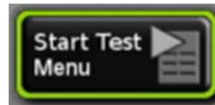

return to the previous screen, then press the (Start Test Menu) button to define the type of configuration each UVA and VIS light bank will run.

Start Test Menu:

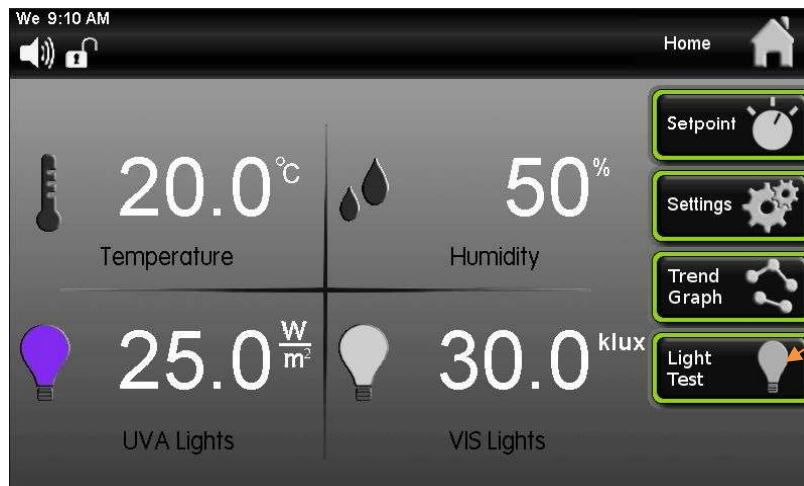

Light Test Button

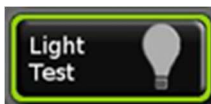

Press the (Light Test) button.



Press the  (Start Test Menu) button.



Select the type of test configuration to run. In the image below only UVA, Exposure test is running.

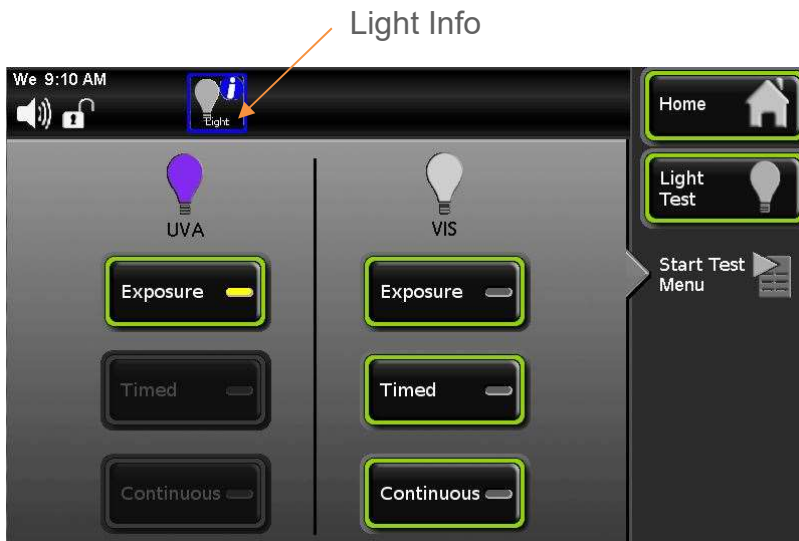

Pressing the Light Info button will access the Photostability Cycle Info screen which displays the status of the current test. From this screen, the test can be paused by pressing the Pause button. The corresponding lights will be off until the test is resumed.

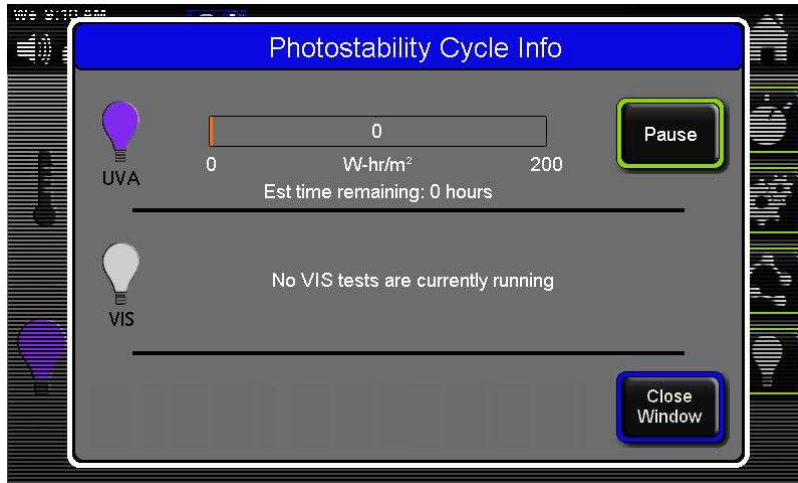

This is an example of the VIS light test that was “Paused”
To continue test, press the “Resume” button.

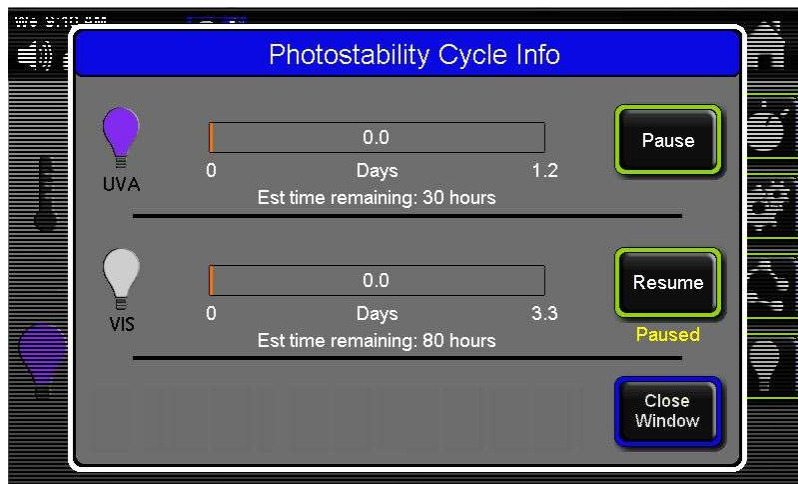

Press the  (Close Window) button to return to the main screen.

The UVA and VIS light banks can be independently configured to the type of light test to be performed.

Trend Graph

This feature allows the user to view a graph that displays the Temperature and Humidity control line over a period of time. This enables user to view the chamber's most recent performance. Trend Graph data cannot be downloaded.



Trend Graph displays Temperature and Humidity. Orange bar indicates current time

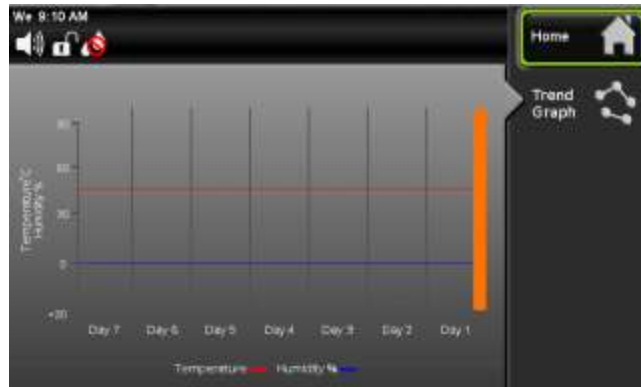

OPTIONAL ACCESSORY OPERATION



Operation of the Data Logger (DLOG301)

The DLOG301 option provides the customer with a means of logging data electronically for viewing at a later date. Logged variables are Temperature, Humidity, and Light Intensity (but only if the chamber is equipped with those features.) All data is time-stamped with year, month, day of the month, hour, minute, 24 hour time (ISO 8601 format). This data is stored internally in the chamber in non-volatile memory.

Note: The date and time are logged within the actual file name. The file's "Date modified" field is not maintained and therefore may not reflect the actual date and time the file was created.

Data is logged every 5 minutes (provided the chamber is on); more than 10 years of data can be stored in memory. If the internal memory fills up, new data overwrites the oldest data.



Continuous writing to the flash drive necessitates a high quality industrial grade device. Use only the flash drive provided by Caron (or equivalent: single level cell memory, wear leveling algorithms, error correcting code).



File name format is "DATE START YYYY-MM-DDTHH-MM_.csv" (hours in 24 hour time)

When the chamber is on, the chamber's history data is being stored even when a flash drive is **not** inserted in the USB port. This data may be retrieved anytime using the provided USB flash drive.

Here are the methods for retrieving data:

Continuous logging of data

Insert the flash drive into the chamber's USB port. When first inserted, it creates a .csv file called 'DATA START' with the current date and time in the file name. At 5 min intervals, the chamber's process values are appended to the file. (The file will get as large as the flash drive, permitting several years of uninterrupted data storage.)

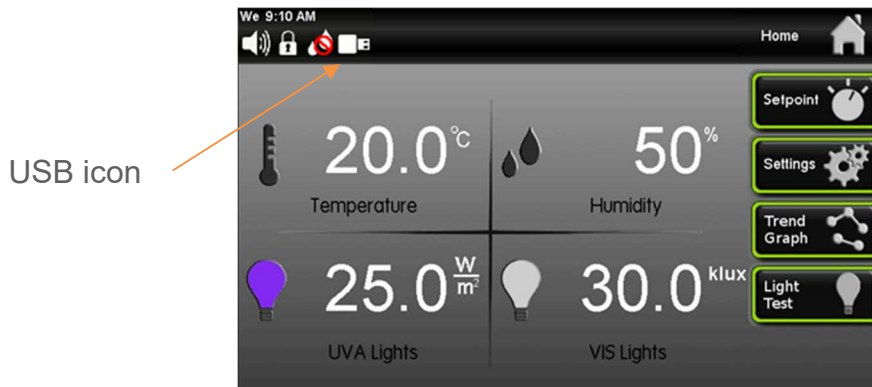

USB icon appears in in Status bar indicating that data is being written to flash drive. To retrieve the data press the 'Eject' button, then insert the flash drive into a computer to upload the data.

Upon re-insertion of the flash drive, a new .csv file is created, even if the old file is still present. File name nomenclature is "DATE START YYYY-MM-DDTHH-MM_ .csv".

History Retrieval



Select the 'Auto Export' feature on the USB menu screen. Insert the flash drive into the chamber's USB port. A new .csv file is automatically created on the flash drive with all the stored history data. The file name nomenclature is "DATE END YYYY-MM-DDTHH-MM_ .csv".

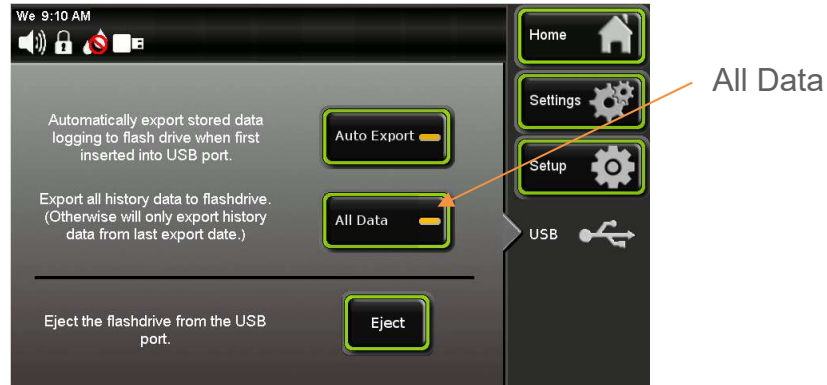

There is also an 'All Data' feature to indicate if the upload should include all data (since the unit has been used) or just the history data since a flash drive was last inserted. An 'Info' button will appear in the status bar warning the user not to remove the flash drive while the data is being uploaded. The length of time to upload the file will depend on the file size. When the 'Info' button disappears from the status bar, press the 'Eject' button to safely remove the flash drive. Now the data can be uploaded to a computer for viewing.

When using the Continuous Logging of Data method, nothing on the touchscreen has to be setup. However using the History Retrieval method will require going into the USB screen to select either the 'Auto Export' or 'All Data' buttons before inserting flash drive into USB port.

To select the 'Auto Export' and 'All Data' buttons.

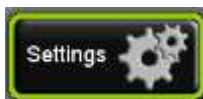
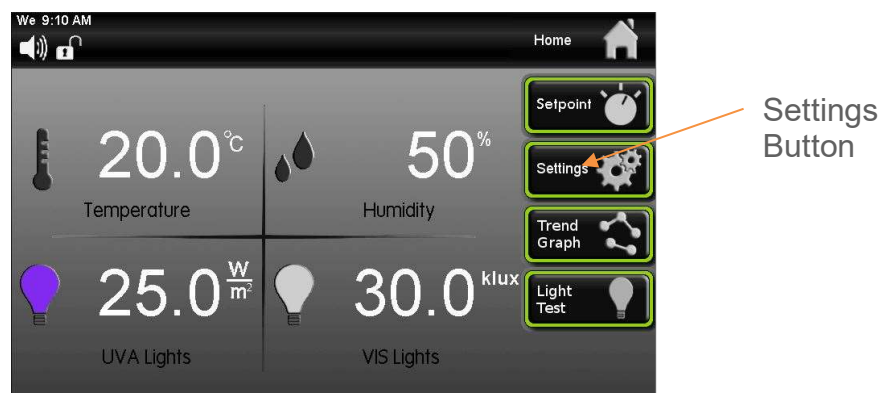

Press the  (Settings) button.



Press the  (Setup) button.



Press the  (USB) button.

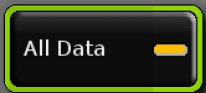

When the 'All Data'  button is selected this will retrieve data starting at the point of the last download, and continuing up to the current time.



When the 'Auto Export' button is selected this will retrieve the data starting at the point of the last download, and continuing to the present time.

USB flash drive icon

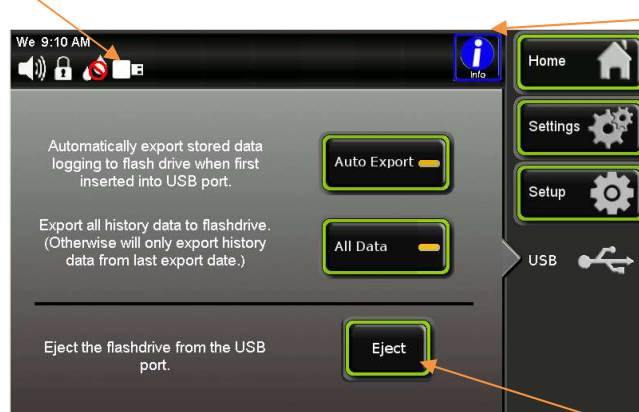

Info button

Eject button

When flash drive is inserted into the USB port a 'USB flash drive' icon and flashing 'Info' button appears in the status bar indicating that the data is being downloaded to

the flash drive. Once 'Info' icon stops flashing select the 'Eject' button.

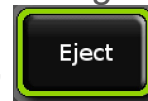

Wait until the USB icon disappears to safely remove the flash drive from the USB port.

Note: Press the Eject button before removing the flash drive from the chamber, otherwise there could be the risk of corrupt data.

Here is a graphic to illustrate how the data retrieval works.

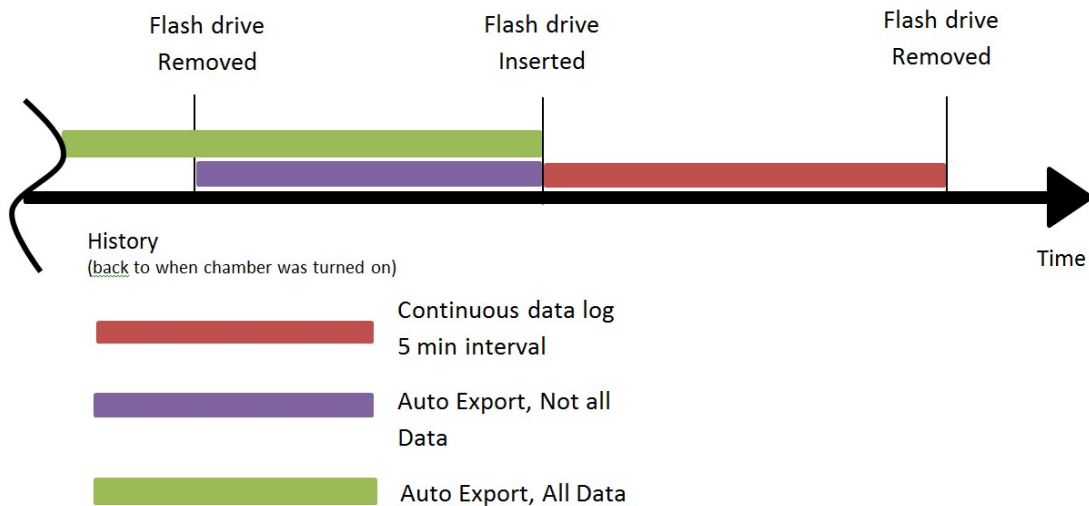

Operation of 12” Side Mounted Recorders (RCDR203, RCDR204)

Side mounted Honeywell DR 4500A Truline Digital Circular Chart Recorders are also available with CARON chambers. This chart recorder uses reliable microprocessor operation to generate dependable drawn analog traces and print its own 12-inch (304.8 mm) charts. The two-pen model accepts inputs from a temperature sensor and a humidity sensor. The single-pen model records temperature only. The recorders are housed in a molded case with a glass window, gray gasketed door which protects internal components while allowing easy access to the chart.

Routine Maintenance:

The recorder does not require any periodic maintenance. However you occasionally will have to clean the pen tip.

Replacing the chart:

Refer to Section Installing/Replacing Chart in the Honeywell manual:

1. Open the recorder door.
2. Press the CHART key. The pen will stop and travel to the outer limit or edge of the chart.
3. Pull up on the pen lifter to raise the pen from the chart plate.
4. Carefully remove chart.
5. Install new chart, make sure edges of paper are under retaining clips.
6. Push pen lifter down to lower pen.
7. Press the CHART key.

CALIBRATION

The temperature, humidity, UVA and VIS light detectors can all be calibrated as necessary. CARON recommends an annual calibration check of each system. Before making a calibration adjustment, allow the cabinet to stabilize a minimum of 12 hours from a power off condition. If the unit has been in operation, allow a minimum of 3 hours of stable operation at all setpoints.

If you do not have the appropriate reference instruments to perform calibration, contact CARON's service department for on-site calibration at www.caronproducts.com Caron also provides validation services which ensure that the unit is functioning properly according to IQ, OQ and PQ protocols which satisfy FDA guidelines for qualification verification of equipment.



Be sure that all reference instruments are calibrated to an appropriate standard.

The Calibration Screen

To get to the calibration screen from the home page:



Settings
Button



Press the  (Settings) button.

Calibrate Button

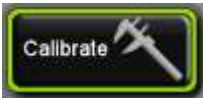

Press the (Calibrate) button.

Temperature Calibrate Button



Humidity Calibrate Button

If optional features such as CO2 are purchased, a calibration button will also appear for those options.

Calibrating the Temperature

If temperature calibration is needed, the following steps can be taken:

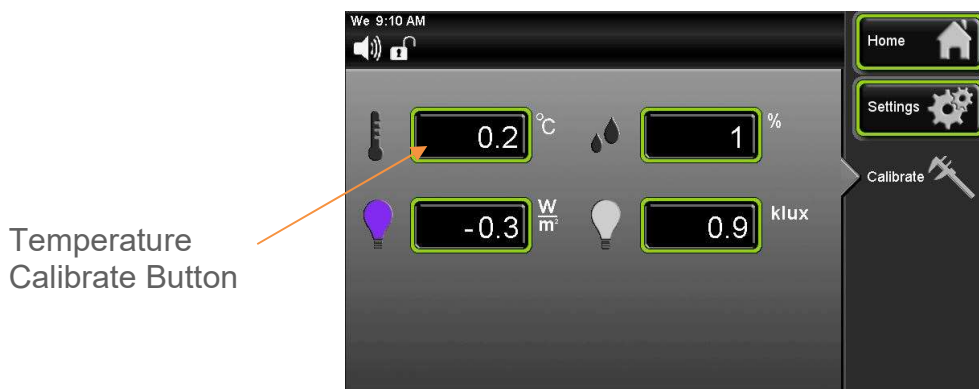

At the calibrate screen, press the  (Temperature Calibrate) button.

Enter the temperature offset by using the keypad and pressing  (Enter) when complete.

Temperature calibration (example)

If the chamber temperature display reads 20.0°C and the calibrated independent sensor shows 20.3°C, set the temperature offset value to 0.3°C. If the calibrated independent sensor shows 19.6°C, then the entered offset should be negative. In this example the required offset to temperature would be -0.4°C.

Use the same steps to calibrate the humidity (model 7545), UVA and VIS light detectors.

Calibrating Optional Chart Recorders

For calibrating the optional front and side mounted chart recorders, refer to section (Optional Accessory Operation)

ALARMS

Alarm System Overview

The chamber control system is equipped with an alarm system that constantly monitors temperature, and humidity (on humidified models) to ensure the user is notified if the cabinet goes into an alarm condition. Notification occurs via an alarm pop-up window and a buzzer. Each alarm condition has been factory programmed to minimize nuisance alarms while maximizing warning time. There is a 2 hour time delay after start-up and setpoint changes. To avoid nuisance alarms after a routine door opening, an alarm condition must be present for 15 minutes* (45 minutes for humidity) before the operator is alerted. If the optional remote alarm contacts are present, in an alarm condition, the dry contacts will change state.

*Alarm delays are adjustable, see “Changing Alarm Setpoints and Delay” for details.

The following alarm messages may be displayed:

- Chamber temperature is higher than setpoint temperature
- Chamber temperature is lower than setpoint temperature
- Chamber humidity is higher than setpoint humidity
- Chamber humidity is lower than setpoint humidity
- Door Open
- Temperature sensor error
- UVA reading is higher than setpoint UVA
- UVA reading is lower than setpoint UVA
- VIS reading is higher than setpoint VIS
- VIS reading is higher than setpoint VIS
- Refrigerant safety sensor error

In the event an alarm occurs, the alarm indicator will appear on the status bar and an audible alarm pop-up window will automatically appear.

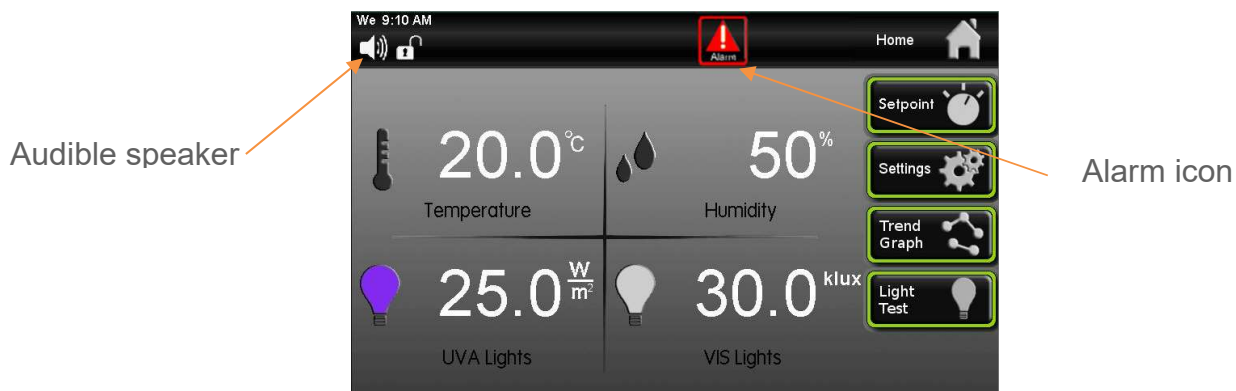



The flashing (Alarm) icon will appear on the status bar.

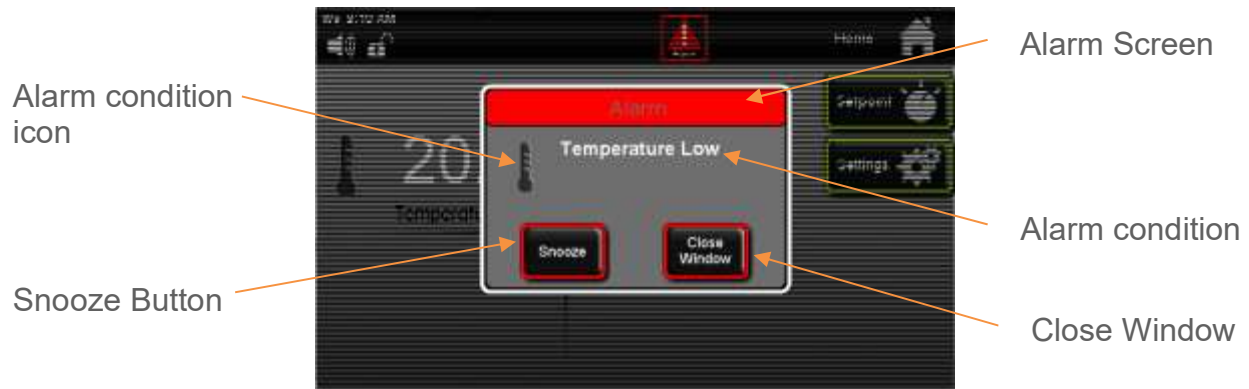

Audible Alarm Snooze Function:

When in an alarm condition, the Audible Alarm can be temporarily silenced to avoid being a nuisance to those nearby. The Audible Alarm will repeat after 1 hour has passed, if the condition has not been corrected. (The audible alarm will not sound if the alarm is muted, see Audible Alarm Mute)



Press the  (Snooze) button, the audible alarm is silenced for a period of 60 minutes.

When the alarm condition is corrected the alarm indicator and the audible alarm will automatically turn off (unless there is another alarm condition).



To check what the alarm condition is, press the  (Alarm) button on the status bar.



and the alarm window will be displayed. If the  (Snooze) button has already been pushed and 60 minutes have not passed the Snooze button will be “greyed” out.



If you press the  (Close Window) button, the Alarm Window will close, but the alarm will still be present as a flashing alarm icon on the status bar for the remainder of the 60 minutes time. It will not reset the 60 minutes alarm countdown time if the alarm condition is viewed on the pop up window.

After the 60 minutes time has passed for an alarm condition, the counter will reset itself to 60 minutes and repeat the countdown process again until the alarm has been resolved.

Audible Alarm Mute:

By factory default, when an alarm condition is present, the speaker will sound. This speaker can be muted in an 'on/off' fashion eliminating all audible sounds. (Muting the speaker will silence it until manually 'un-muted'. This is different than 'snooze' in the fact that snooze can only be enabled when an alarm condition is present and only lasts for 1 hour.) When the speaker is muted, the alarm icon continues to flash and the remote alarm contacts (optional) remain in the 'alarm' state.

To mute the speaker:

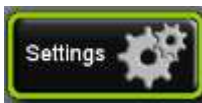

Press the  (Settings) button.

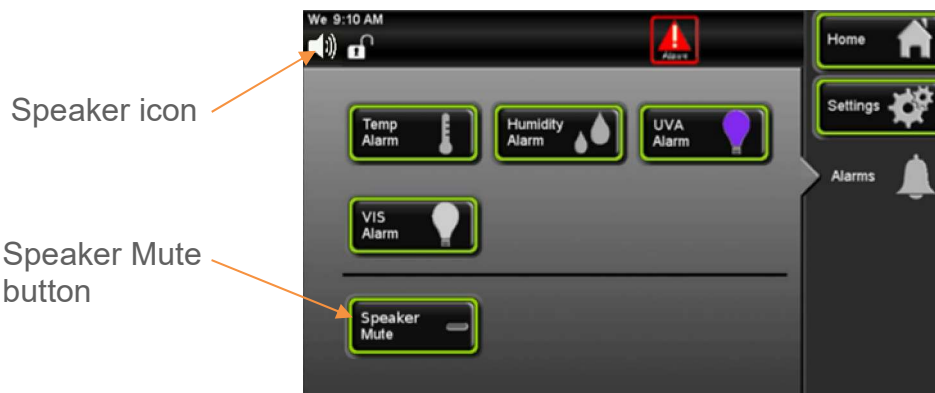

Press the  (Speaker Mute) button.



The Speaker Mute button toggles to the "on" position



icon changes to "Speaker Muted" icon.

Changing Alarm Setpoints and Delay

All alarm setpoints were pre-set at the factory to minimize nuisance alarms that could be created as a result of door openings. Alarm setpoints can be changed based on individual user requirements. Alarm values are deviations from the setpoint and are not actual setpoint values. To change the alarm setpoints and delay:



Settings Button

Press the  (Settings) button.



Alarms Button

Press the  (Alarms) button.

UVA Alarm Button

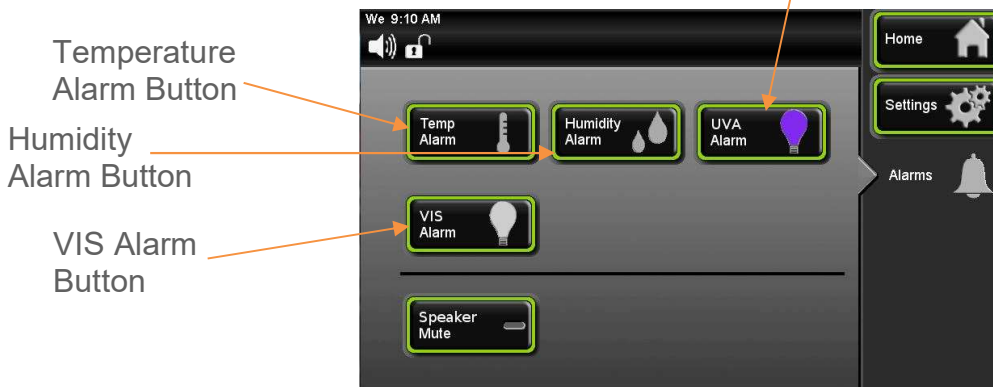



Temperature Alarm Button

Humidity Alarm Button

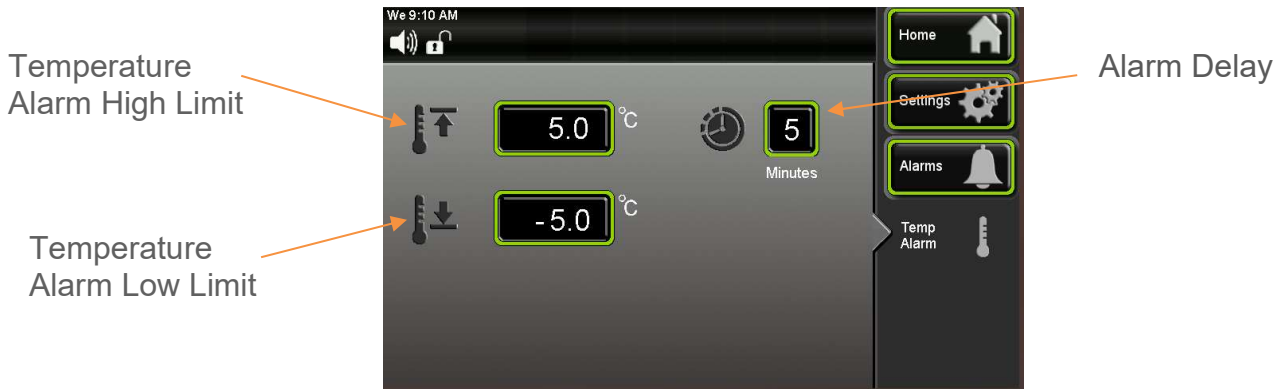

VIS Alarm Button

Press the  (Temp Alarm) button.

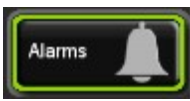

Once the alarm screen appears, press the  (Temp High Limit) button.

Keypad screen will appear. Enter the High Temp Alarm value; press  (Enter) when complete.

To change the Humidity Alarm, press the  (Alarms) button on the navigation menu to go back to the Alarms screen. Press the  (Humidity Alarm) button and repeat the same steps for humidity.

To change the alarm delay, press the alarm delay button  and enter the delay in minutes.

UVA and VIS Light Alarms

Both UVA and VIS have intensity level alarms. Units with light dimming capabilities also feature high and low limit alarms. Non-dimming units only have low limit alarms. Alarm values are deviations from the setpoint and are not actual setpoint values. On the Alarms screen choose UVA or VIS to set the values.

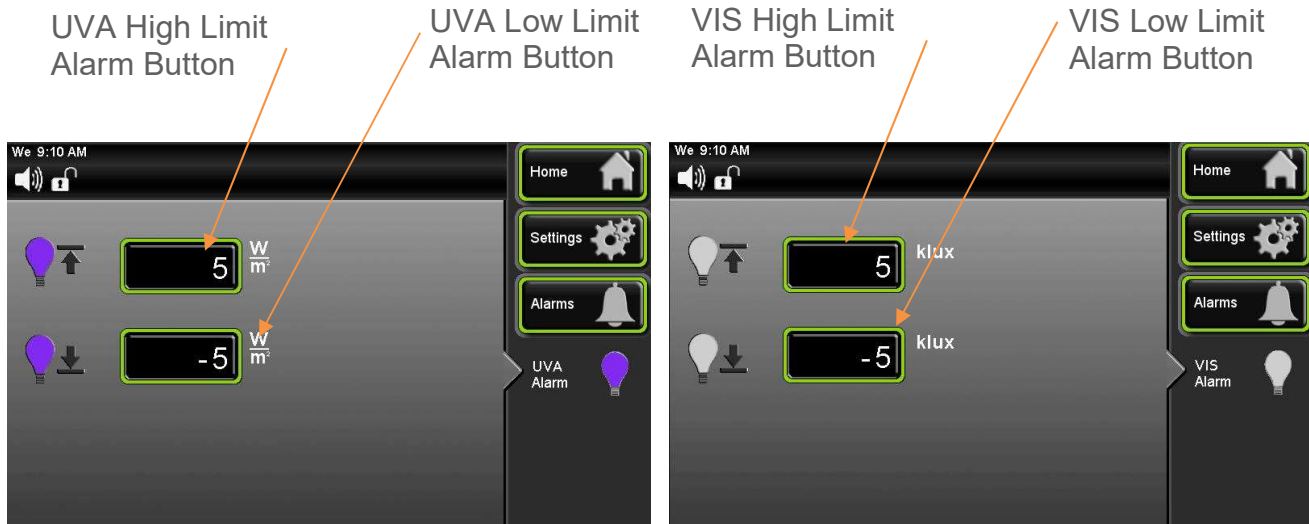

Dimming lights

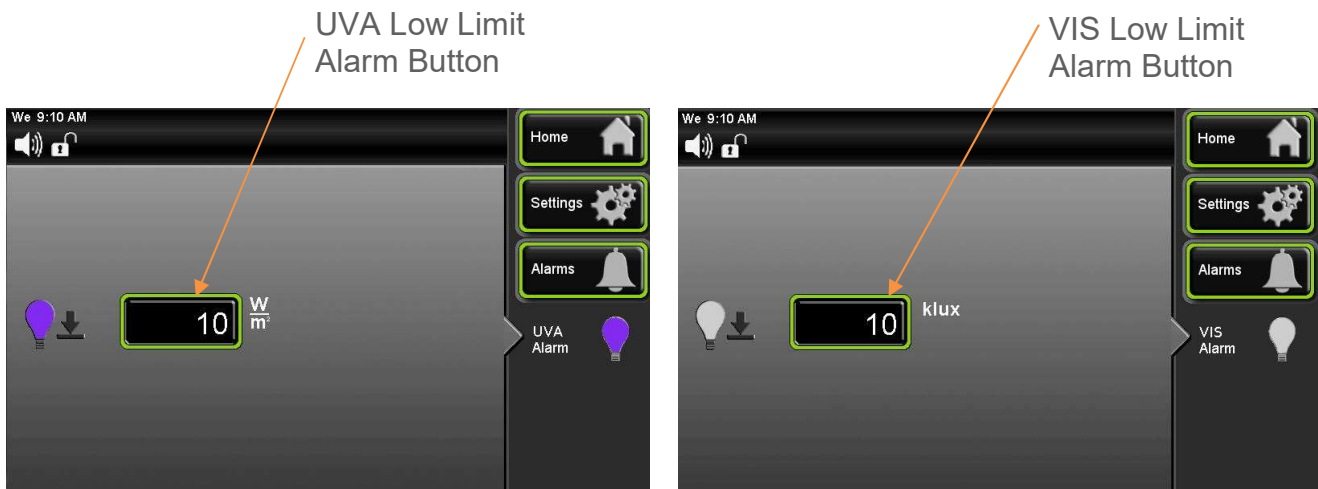

Non-Dimming lights

Humidity Alarms

Humidity Alarms also differ by model.

Model 7545, which does control humidity, both high and low limit alarms may be set. Alarm values are deviations from the setpoint and are not actual setpoint values.

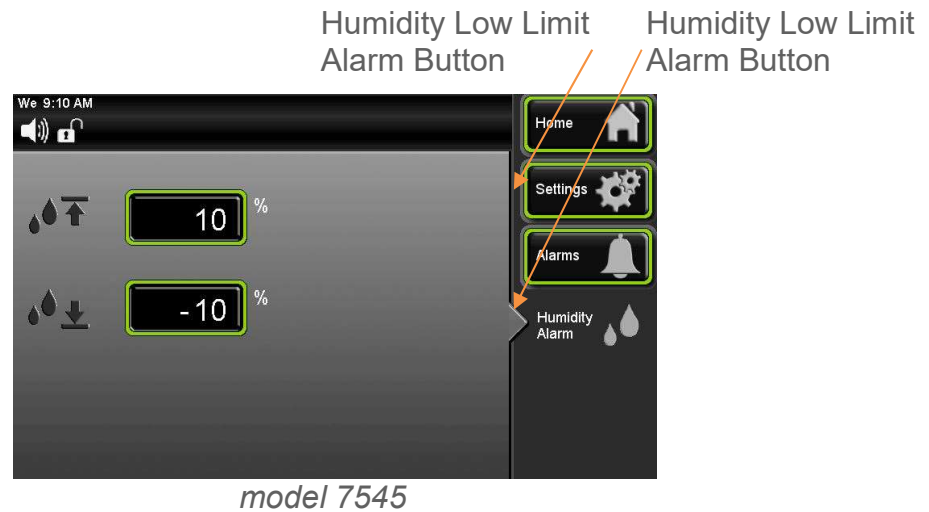

ALERTS

Alert System Overview

The chamber control system is equipped with an Alert system that constantly monitors features of the chamber and notify the user if the cabinet needs any type of service to ensure good running performance of the chamber. Alerts draw user attention to regular maintenance needs, and minimize the risk of a future alarm condition.

When an Alert notification occurs, contact www.caronproducts.com with the serial number of the chamber to order preventative maintenance kit(s).

Some of the Alert features are Replace the Lamps, Replace the Air Filter, and Equipment Calibration Is Due.

Notification occurs via an Alert icon on the status bar. When the Alert icon is pressed, a pop up window will display the alert condition(s). Each alert condition parameter is factory pre-set, no adjustment is necessary.

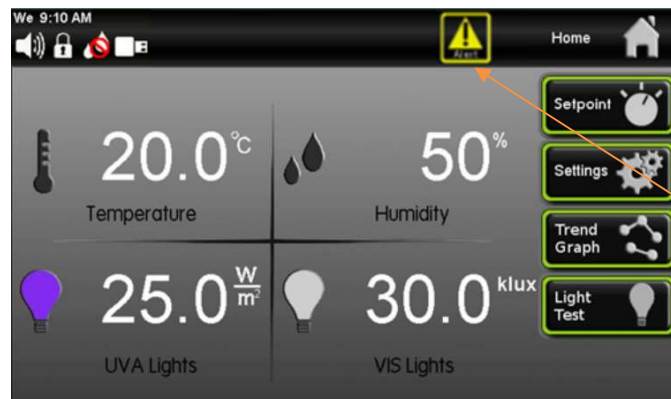

Alert icon



Press the  (Alert icon).

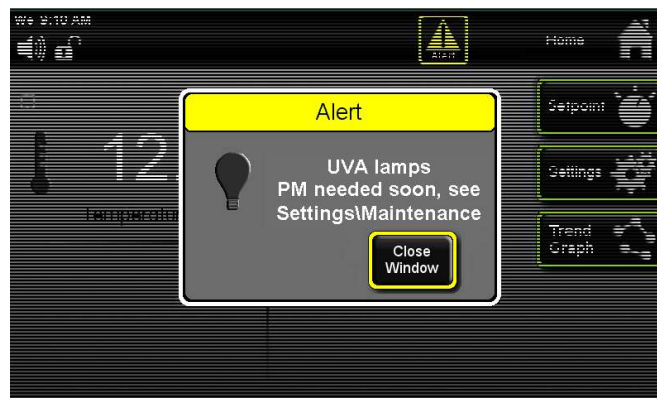

The Alert pop up window will appear displaying the alert message.



Press **Close Window** (Close Window) button to make the pop up window disappear.

Resetting Maintenance Alerts

Maintenance Menu Screen lets users check to see how much time is remaining on an item that may need routine service or calibration. This is very convenient to inform the user that a particular item will need to have service performed soon. After service has been completed, the item needs reset and the Alert will disappear.

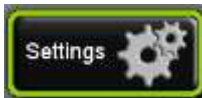
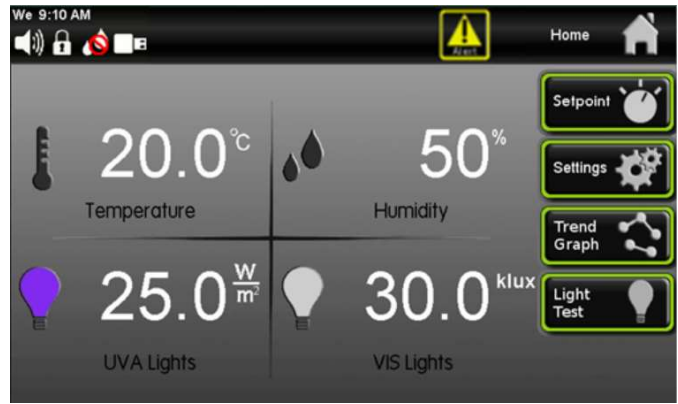

Press the **Settings** (Settings) button.



Once the Settings screen appears, press the **Maint.** (Maintenance) button.

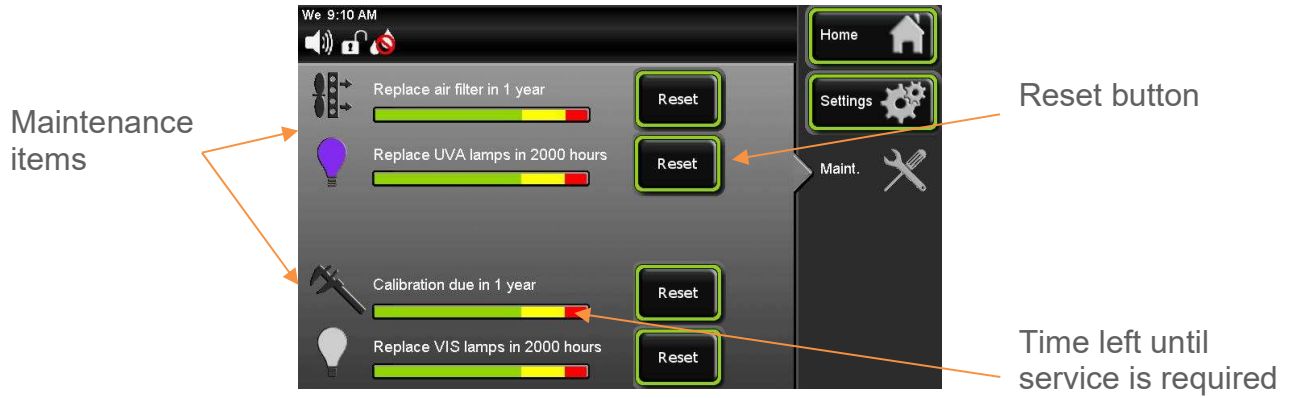

Once a Maintenance item is displayed on the Alert screen, it will continue to be present

as an icon in the Status Bar until the Maintenance item is corrected and the (Reset) button is pressed resetting the replacement time to “new” status.



Press the  (Home) button to return to the main screen.



INFO

Info System Overview

The chamber control system is equipped with an Information system that constantly monitors the chamber and to notify the user when an automatic condition is occurring. This applies to conditions such as during the initial start up when the lights are disabled from turning on but is controlled automatically by the software of the control system. This notification cannot be disabled, it only lets the user know the chamber's current status. Notification occurs via an Info pop-up icon on the status bar. When the Info icon is pressed a pop up window will display the Info condition(s).

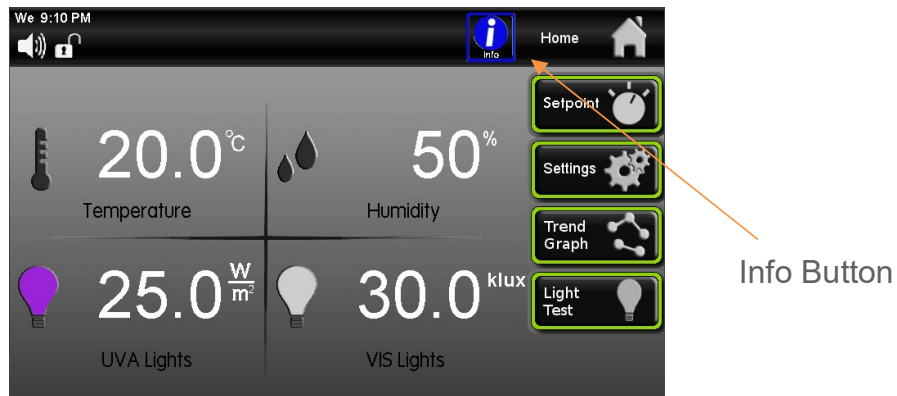

The  (Info) icon will appear on the status bar.

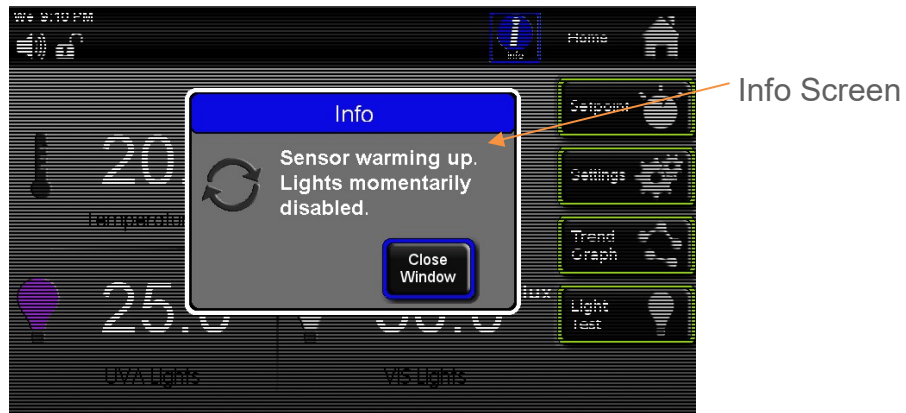

Press the  (Close Window) button to return to the main screen.

ADVANCED FEATURES

Setting the time & day

The chamber has an internal real-time clock that keeps track of the day and time. It is set at the factory to Eastern Standard Time and may need to be adjusted for your time zone. To keep the clock accurate, it will need to be adjusted manually for daylight savings time changes. To set the day & time:



Settings Button

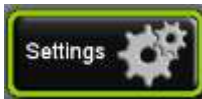

Press the (Settings) button.



Setup Button



Press the (Setup) button.

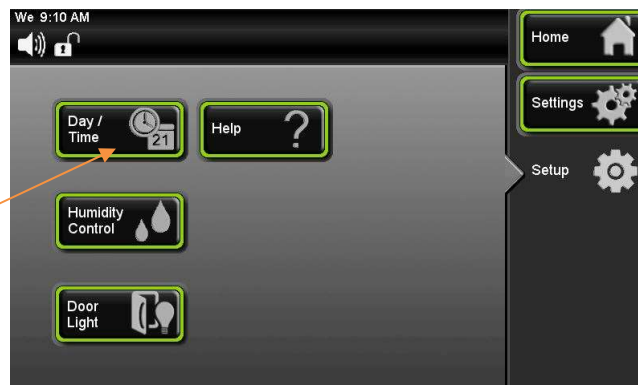

Day/Time Button

Press the  (Day / Time) button.



Press the  (Hour) button.

The Enter New Time in Hours window will appear. Enter the hour by using the keypad and pressing  (Enter) when complete.

Follow same procedure for setting up minutes.

To setup AM/ PM, Press  (AM /PM) button and the words for AM and PM will toggle back and forth.

To set the Day of the Week, press the  (Day of the Week) button. This button will scroll through the days of the week, press until the abbreviated letters correspond to the actual day of the week.

Press the  (Home) button to return to the main screen.

Setting the Humidity Control

The setup menu also allows the humidity control to be enabled or disabled. At the Setup screen press the Humidity Control button. This function enables or disables humidity control. When the feature is disabled, it will only display the humidity levels that are inside the Photostability chamber.

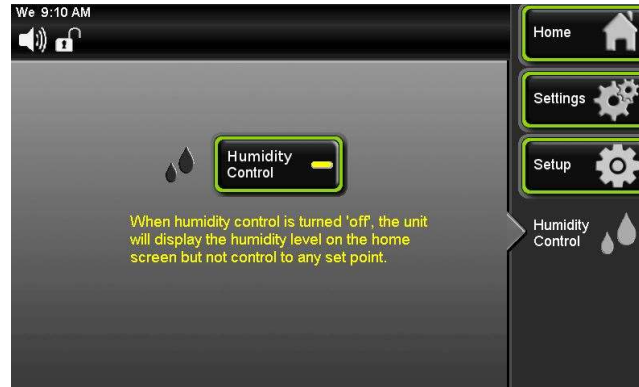

Setting the Door Light

The Photostability chamber also permits the user to set whether or not chamber lights remain "on" when the door is opened.



Be sure to wear eye protection if Door Light button is enabled.

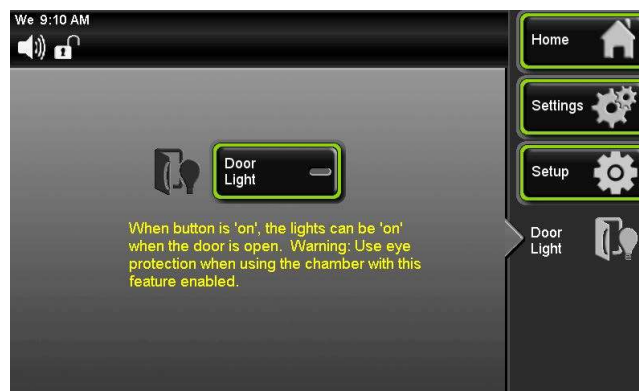

Locking the Controls

To prevent unauthorized and accidental setpoint changes, the touchscreen can be locked-out. The passcode is required to lock-out the controls and the same passcode is used to unlock it. The factory default passcode is '1234'. This passcode can be changed by the user to create a unique 4-digit passcode. There is also a feature that will let you change the passcode from the factory default to a user defined passcode. The factory default for the screen lock is "unlocked".

To lock the touchscreen,

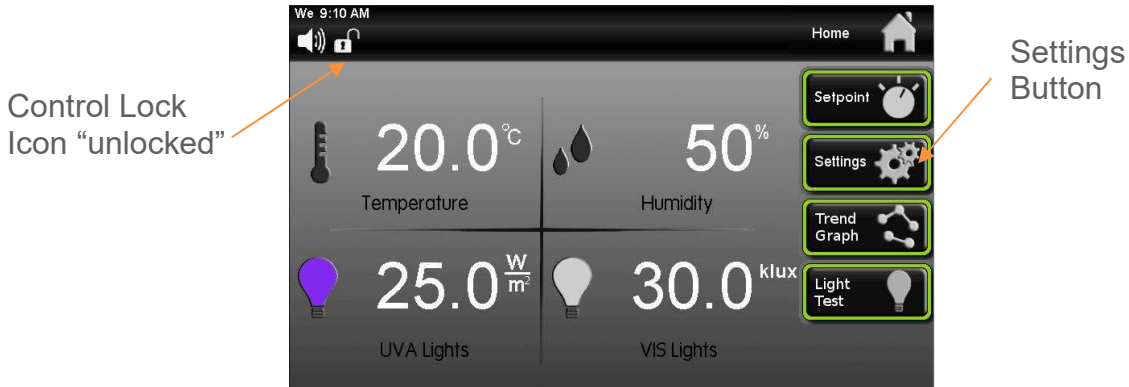

Press the  (Settings) button.

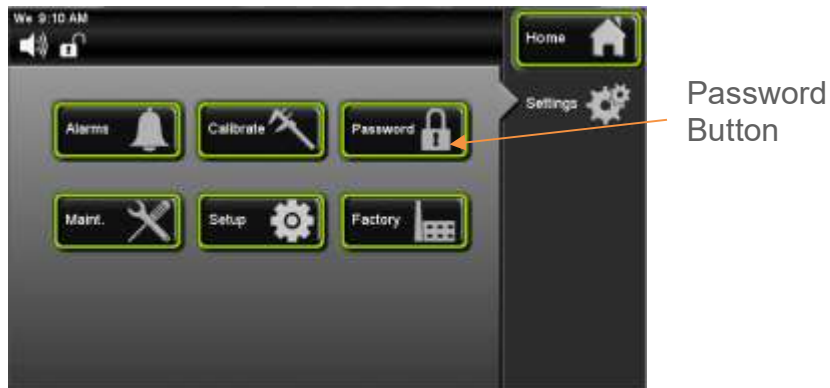

Press the  (Password) button.



Press the  (Lock Keypad) button.



The Enter the Current Passcode keypad screen will appear.



Enter digits “1 2 3 4”; press  (Enter) when complete.

The screen will change back to the Home Screen and the Control Lock icon will change to the “locked” position.

Control Lock Icon "locked"

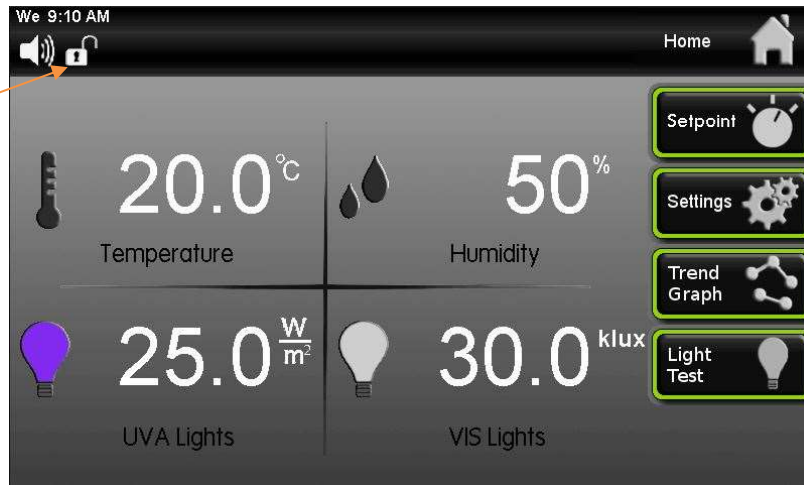

When any button is pressed on the home screen the following pop-up window will appear. If the  button is pressed, the screen will change back to the Home Screen.

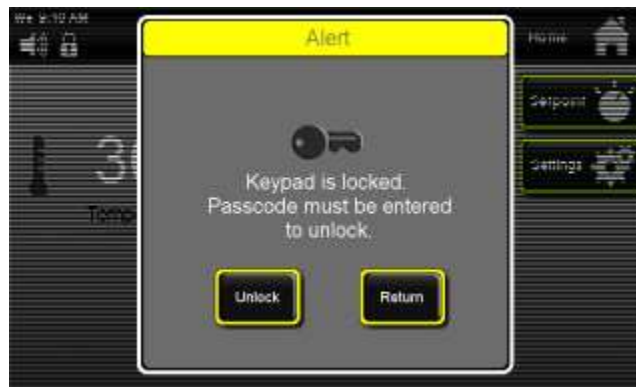

To unlock the touchscreen,

From the previous Alert "Keypad is Locked" pop up screen, press the (Unlock) button. The Enter New Passcode window will pop up.



Enter the digits “1 2 3 4”; press  (Enter) when complete. The Control Lock Icon will change back to the “unlocked” position.

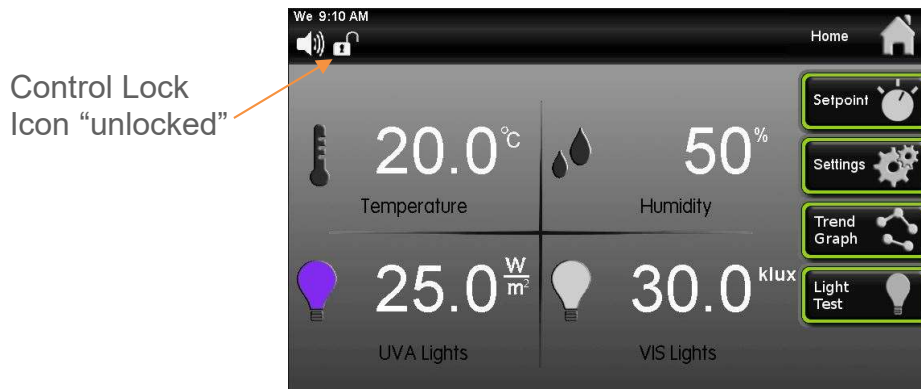

Changing the passcode

To prevent unauthorized and accidental changes being made to the chamber, the touchscreen can be locked-out. The passcode is required to lock-out the controls and the same passcode is used to unlock it. The factory default passcode is ‘1234’. This passcode can be changed by the user to create a unique 4-digit passcode. The current passcode is required to change the passcode.

To lock the touchscreen,

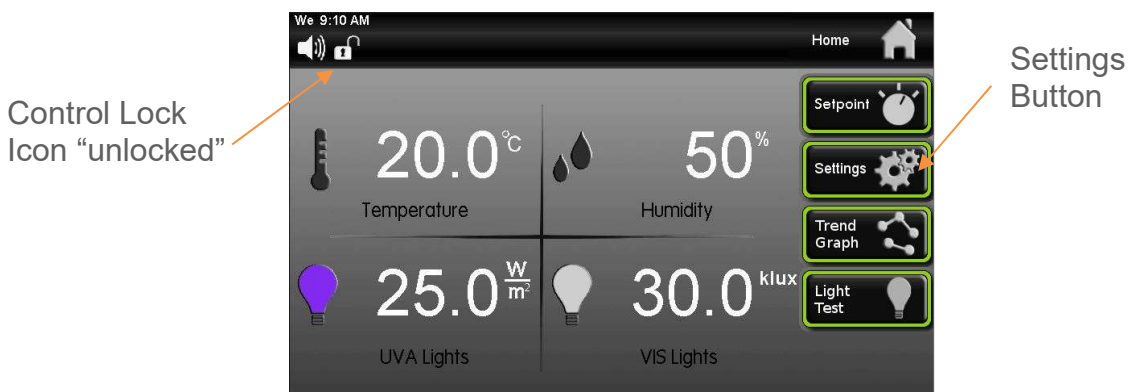

Press the  (Settings) button.



Password Button

Press the  (Password) button.



Press the  (Change Passcode) button.



The Enter Current Passcode keypad screen will appear.



Enter digits “1 2 3 4”; press  (Enter) when complete.



The Enter New Passcode keypad screen will appear.



Enter any new four-digit passcode (example: “2 5 8 0”). Then press  (Enter) when complete.



The Lockout screen will tell you that the Passcode has been changed to a new value. *This is only time that the Passcode will be displayed on the Lockout screen.*

Factory menu & troubleshooting

The chamber control system is equipped with advanced diagnostics features which allow the user to manually turn 'on' & 'off' each electronically controlled system. The factory menu can be used to

- View the current chamber configuration
- See the percent output of the control system
- Manually and individually toggle any output

To access the Factory Menu,

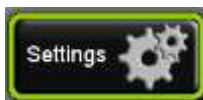
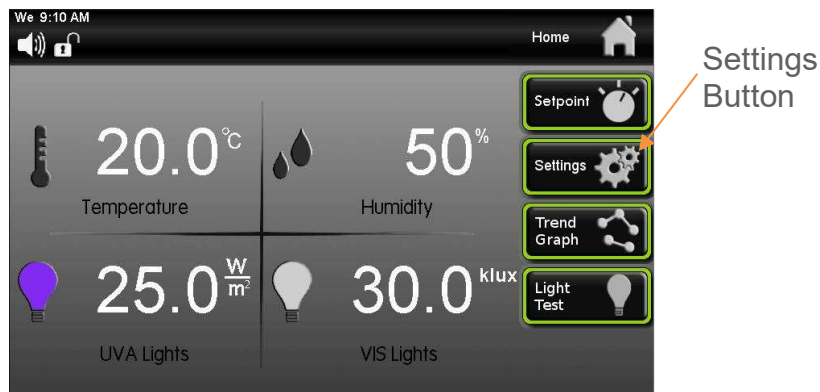

Press the  (Settings) button.

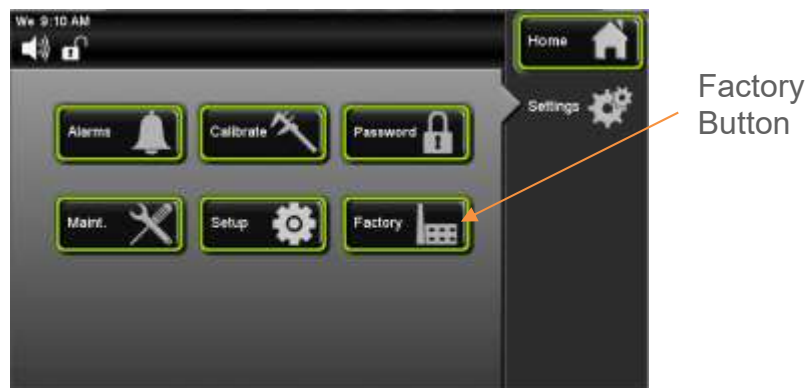

Press the  (Factory) button.



From the factory menu, four items can be selected. Press the **Model Details** (Model Details) button to view the chamber's configuration

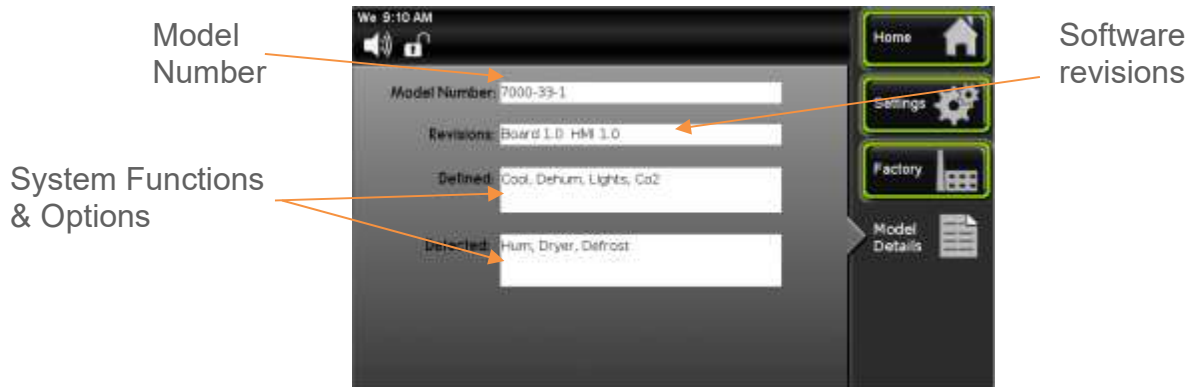

From the Factory screen, press the **Output Percent** (Output Percent) button to view the current percent output level of each control parameter.

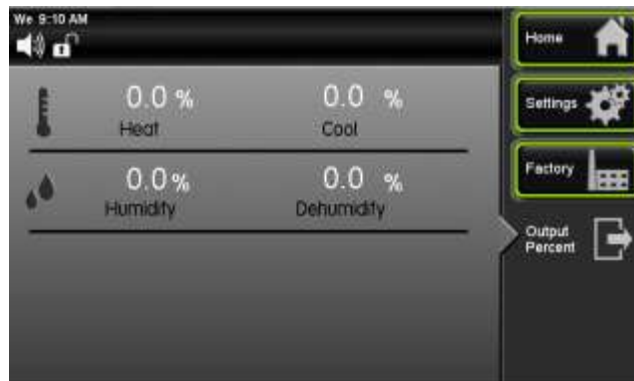

Output
1 & 2
Buttons



Navigating to the Output 1 or Output 2 screens in the factory page will temporarily halt chamber control & functionality.

To individually and manual control each output variable, from the factory screen press



the  (Output 1) button. Note: Based on the chamber model number and options, not all functions will be present.

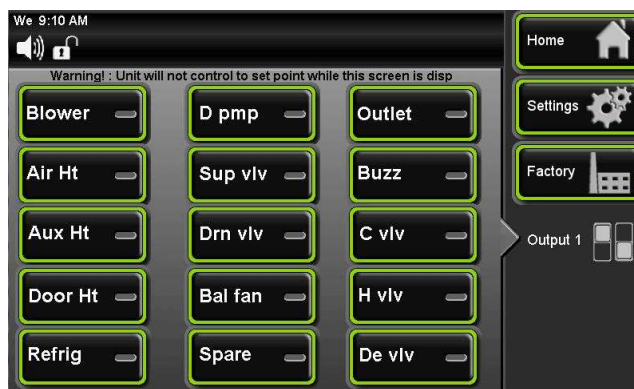

Each item can be turned on to check the condition of that device or parameter to aid in diagnosing a problem.



Press the (Output 2) button for other parameter buttons.



Chamber control & functionality is restored as soon as the screen is exited (Home, Settings, or Factory buttons) .When finished with diagnosis in Output 1 or Output 2



screen, press the (Factory) button to return to that screen. Once you go back to the Factory screen all parameters that were selected in Output 1 or Output 2 screens will reset to the “off” position.



Press the (Home) button to return to the main screen.

PREVENTATIVE MAINTENANCE

The CARON Photostability chamber has been robustly designed to minimize performance problems. However, regular maintenance is very important for continuous trouble free operation.

As a general rule, CARON recommends an annual calibration check of the temperature and humidity systems and UVA and VIS light detectors. CARON offers a full range of on-site calibration and validation services. We also offer preventative maintenance contracts on our equipment. Contact our Service department for details at 740-373-6809 or visit us on the web at www.caronproducts.com.

Recommended Daily Maintenance Checks

- Check the Temperature and Humidity displays versus setpoints.
- Check UVA and VIS displays versus setpoints
- Check for and correct any alarm condition.

Recommended Monthly Maintenance Checks

- Check to ensure the chamber drain on the unit is draining properly.
- Check front air intake filter. If it is dirty replace it with CARON part number PM-FLTR311. Washing the filter will result in poor performance.
- Drain internal reservoir if chamber is going to be unused for 10 days.
- Check Maintenance status on lamps and if they are at the end of their useful life.

Recommended Annual Maintenance Checks

- Check ultrasonic humidifiers, verify they are operating properly.
- Disinfect all interior surfaces with a general purpose laboratory non-abrasive cleaning agent.
- Perform a complete calibration of the temperature and humidity systems, and UVA & VIS light detectors.

A full validation is recommended for GMP facilities each time a unit is installed, moved or undergoes significant repair. Contact CARON's service department at www.caronproducts.com or 740-373-6809 to schedule on-site validation.

Here is a list of PM Kits that are available for models and accessories covered in this manual.

Model	PM Kit
7540-1	PM-7540-1-UVA
7540-1	PM-7540-1-VIS
7540-2	PM-7540-2-UVA
7540-2	PM-7540-2-VIS
7540-3	PM-7540-3-UVA
7540-3	PM-7540-3-VIS
7545-1	PM-7545-1-UVA
7545-1	PM-7545-1-VIS
7545-2	PM-7545-2-UVA
7545-2	PM-7545-2-VIS
7545-3	PM-7545-3-UVA
7545-3	PM-7545-3-VIS
ALL	PM-FLTR311

Accessory	PM Kit	Models
BOTL302	PM-BOTL302	7545
RCDR203	PM-RCDR203	7540
RCDR204	¹ PM-RCDR204	7545

¹model 7545

• SPECIFICATIONS

Model	7540-1	7540-2-3	7545-1	7545-2-3
Lamp Type / UVA	Fluorescent / Near UV (<i>Black Lamp</i>)			
Lamp Type / VIS	Fluorescent / Cool White (<i>ISO 10977 Compliant</i>)			
Light Detectors	UVA and Visual / Calibrated			
UVA Intensity (Typical)	20 W/m ²	2-30 W/m ²	20 W/m ²	2-30 W/m ²
VIS Intensity (Typical)	20 klux	2-35 klux	20 klux	2-35 klux
Lamps Dimming	N/A	YES	N/A	YES
Time Required to Reach ICH of 200 W-hr/m ²	10 hrs.	7 hrs.	10 hrs.	7 hrs.
Time Required to Reach ICH of 1.2 million lux-hr	60 hrs.	35 hrs.	60 hrs.	35 hrs.
Light Uniformity	UVA:±10% VIS:±15%	UVA:±10% VIS:±10%	UVA:±10% VIS:±15%	UVA:±10% VIS:±10%
Temperature Range	10°C to 35°C (<i>Lights On</i>)**			
Temperature Control	± 0.2°C			
Temperature Uniformity	± 2.5°C (<i>Lights On</i>)			
Humidity Range	N/A 40-70% RH			
Humidity Control	N/A ±3%			
Shelf Count	Two (2) Sliding / 26.0"W x 23.1"D x 8"H Each (660mm W x 587mm D x 203mm H)			
Usable Shelf Area / Each	19.0"W x 23.0"FB (483mm x 584mm)			
Usable Shelf Area / Total	6.1in. 2 ft. ² (0.56m ²) / 76% of Total Shelf			
Maximum Weight	22 lbs. Per Shelf (10 kg)			
Interior Surfaces	Reflective Specular Aluminum			
Interior Construction	Stainless Steel			
Internal Volume	11cu.ft. (311L) / Includes Lamp Space			
Exterior Dimensions	37.7"W x 30.8"D x 45.7"H (958mm W x 782mm D x 1161mm H)			
Interior Dimensions	26.9"W x 24.0"D x 28.0"H (683mm W x 610mm D x 711mm H)			
Access Ports	Two (2) / 2"W x 1.8"H Each (51mm W x 46mm H)			
Shipping Weight	580 lbs. (700 lbs. With Export Crate)			
* Specifications are subject to change without notice. Specifications were established with lights fully 'on' at 25°C, 50% RH and RH levels limited by a 5°C minimum dewpoint. 50 Hz units are CE Marked and contain readily available European components. **When calibrated to the median average temperature.				

* Intensity: The rate at which the energy from the light is received at a unit of surface.

Model	7540-11			7545-11			
	-1	-2	-3	-1	-2	-3	
Shipping Weight	580 lbs. (263 kg.)			700 lbs. (317 kg.)**	580 lbs. (263 kg.)		700lbs. (3 kg.)**
Electrical	115V, 60Hz, 15A	230V, 60Hz, 10A	230V, 50Hz, 10A	115V, 60Hz, 15A	230V, 60Hz, 10A	230V, 50Hz 10A	

**Includes export shipping crate

Specifications are subject to change without notice.

Environmental Conditions: Temperature 15°C to 25°C, Humidity non-condensing

*See graph for details

7540, 7545 Series units have forced internal air flow of 440 cfm (12459 LPM)

• ELECTRICAL SCHEMATICS

HIGH VOLTAGE MAIN WIRING HARNESS

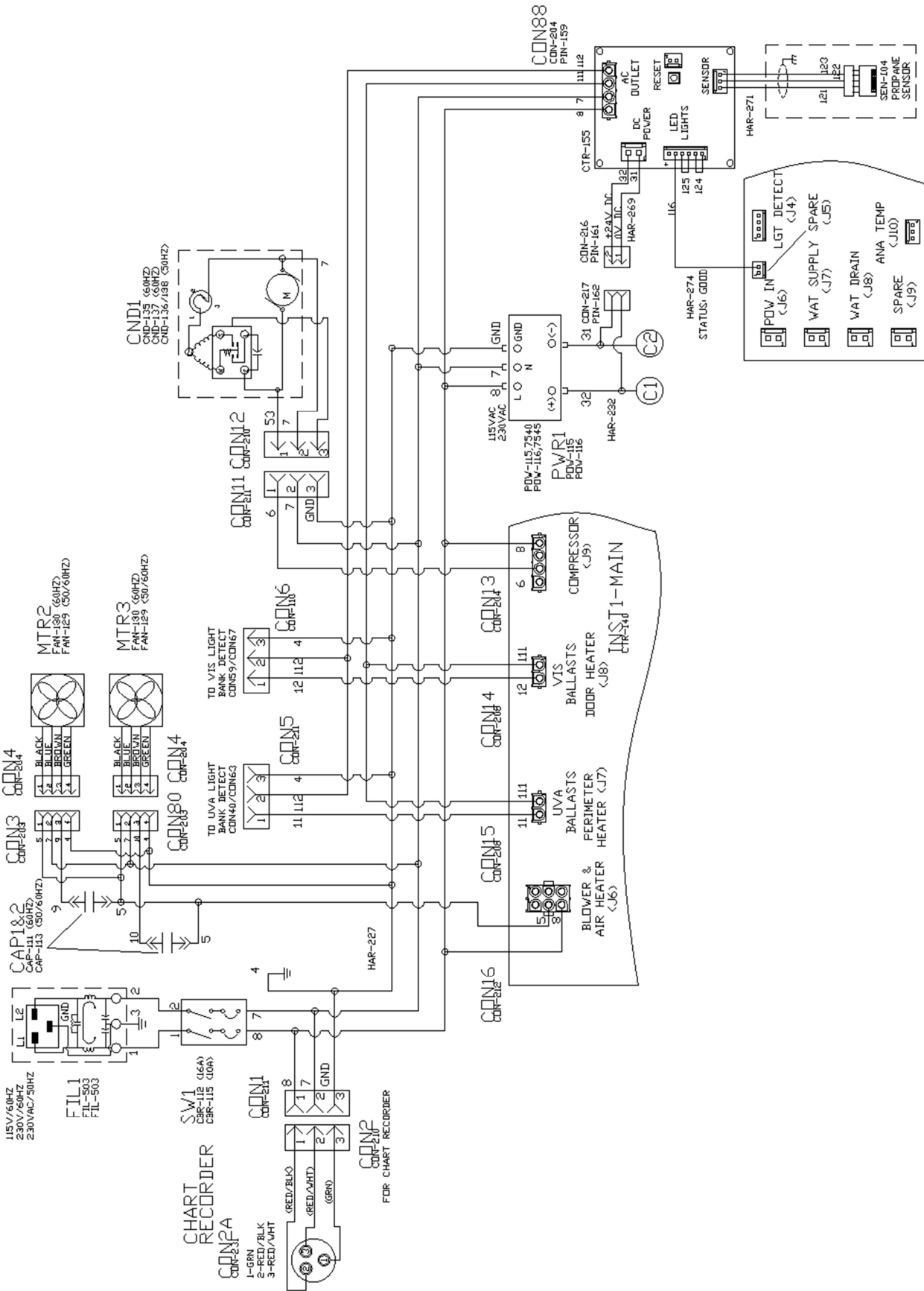

INST3-PHOTO STABILITY

754X-11-2,-3 DIMMING

ALL WIRING SOLID 18GA UNLESS OTHERWISE NOTED

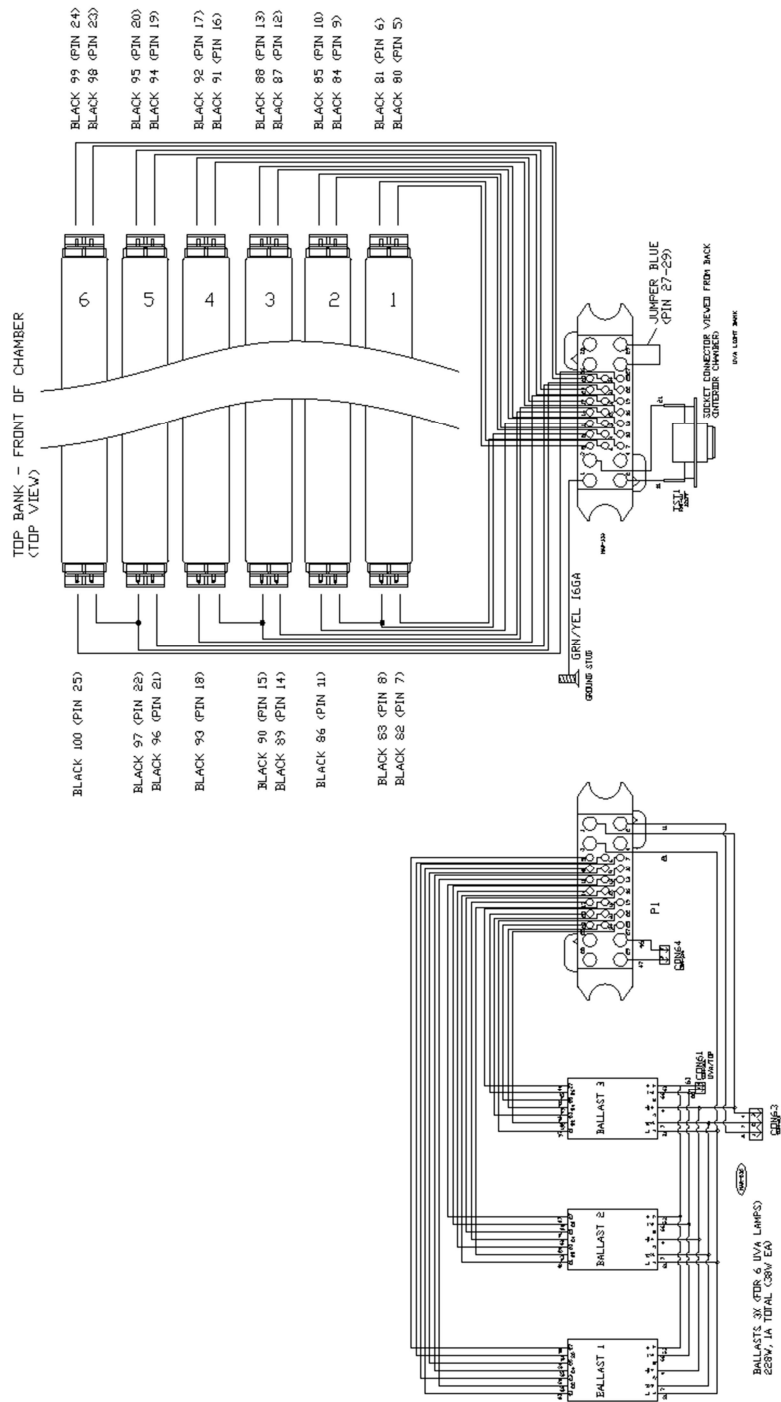

754X-11-2,-3 DIMMING

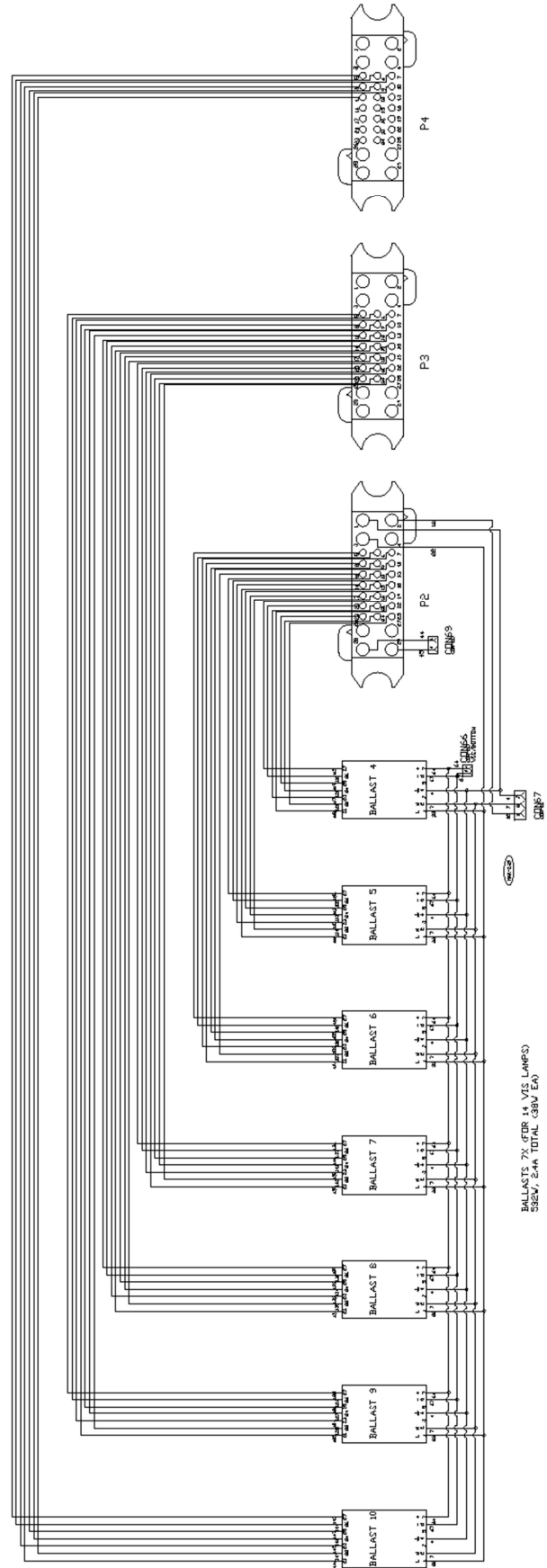

754x-11-2,-3 DIMMING

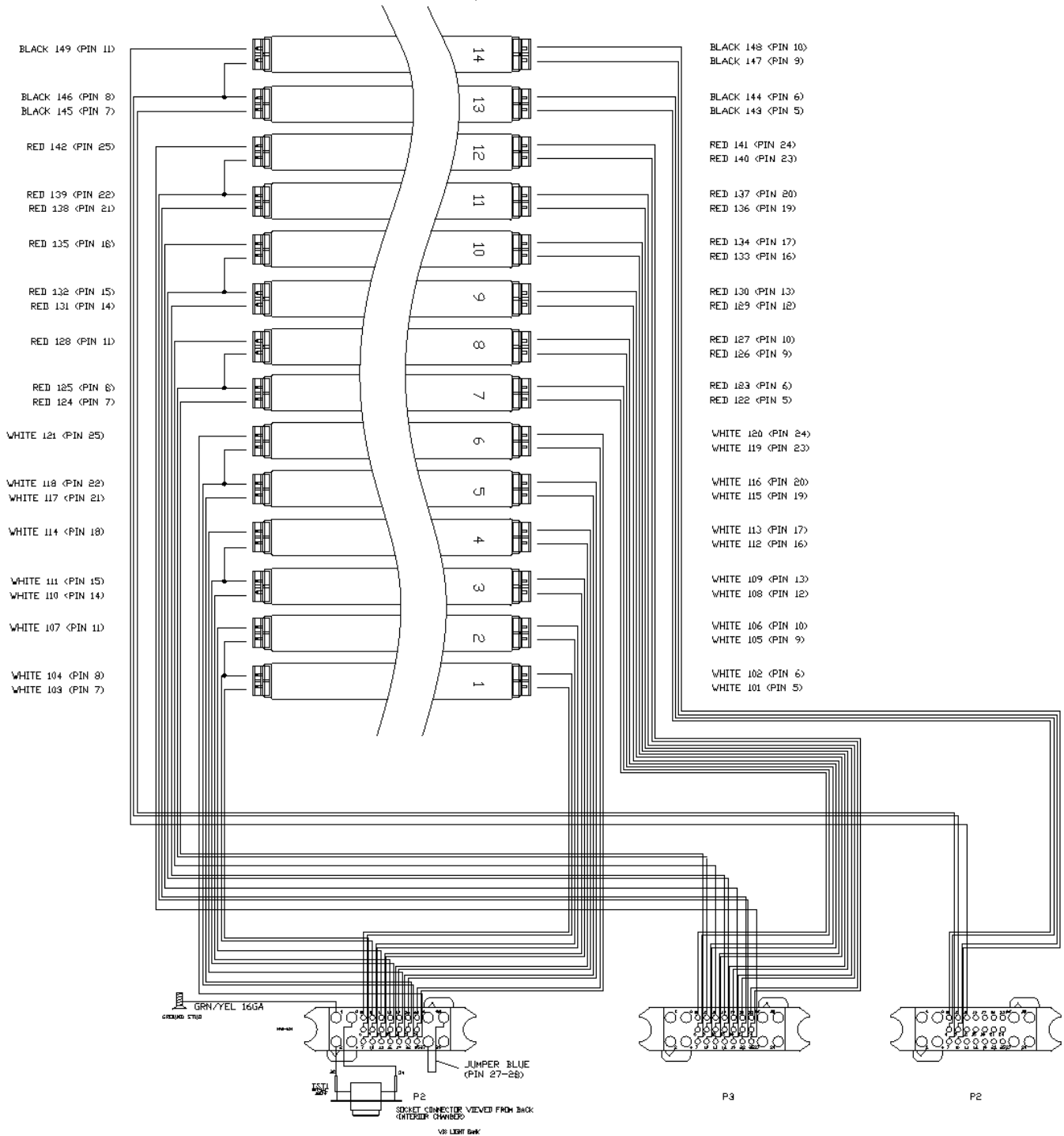

TROUBLESHOOTING

Problem -- Unit will not turn on

- Is the unit connected to a dedicated electrical circuit as defined in the installation section of the manual?
- Is there power at the electric outlet the unit is plugged into?
- Is the unit's power switch turned on?

Problem -- Unit temperature is above / below temperature setpoint

- Has the unit's temperature setpoint been recently lowered / raised and if so has the unit been allowed 12 hours stabilize at the new setpoint?
- Has the door been recently opened for an extended period of time?
- Is the door closed?
- Are the access port stoppers installed in the cabinet?
- Is the condenser filter on the front of the cabinet clean?

Unit humidity level is above / below humidity setpoint.

- Is the unit connected to a water source as specified in the installation section of the manual?
- Has the unit been leveled to insure the cabinet drain works correctly?
- The cabinet's drain line uses gravity to remove water. Does the drain line have any rises in it above the cabinet's drain level that could be trapping water?
- Has the unit's humidity setpoint been recently lowered / raised and if so has the unit been allowed time to stabilize at the new setpoint?
- Has the door been recently opened for an extended period of time?
- Is the door closed?
- Are the access port stoppers installed in the cabinet?
- Is the condenser filter on the front of the cabinet clean?

Lights will not come on, some bulbs are not on in the light bank.

- Make sure light banks are installed correctly into connector.
- Check the Light Test Menu, make sure that 1 of the 3 configurations have been selected.
- Check the lamps in the light banks, make sure they are secure and seated in the light fixture(s).
- Lamp(s) could be expired.

SPARE / REPLACEMENT PARTS



CAUTION: Before servicing the unit, the mains power supply cord must be unplugged to avoid risk of shock. Any area of the unit that requires a tool to access shall only be serviced by trained personnel approved by Caron Products.



R290 REFRIGERANT UNITS

Do not damage the refrigeration circuit. Component parts shall be replaced with like components and servicing shall be done by authorized personnel to reduce the risk of possible ignition.

Fuse Related

NOTE: All fuses are slow blow

ID	Description	115V	230V
SW1	Main circuit breaker switch	CBR-112 (16A)	CBR-115 (10A)

General

Part Number	Description
CRD-110	Power Line Cord (115V 60Hz)
CRD-112	Power Line Cord (230V 60Hz)
CRD-108	Power Line Cord (230V 50Hz)
CTR-140	Main Controller Board
CTR-153	Photostability Board
FAN-130	Blower, 115V
FAN-129	Blower, 220V
POW-115	Power Supply, 75W, 24VDC
STP-101	2" rubber port stopper



The mains power supply cord must be replaced by the corresponding CRD part number above. The use of an inadequate mains power supply cord could result in equipment failure or personal harm to the user.

Temperature Related

Part Number	Description
RTD-101	Temp Sensor -- RTD 100 Ohm Platinum
CMP136	115V / 60Hz Condensing Unit
CMP-137	230V / 50/60Hz Condensing Unit
SOL-147	Refrigeration Cooling Solenoid

Humidity Related

Part Number	Description
LEV-104	Level Switch
HUM-110	RH Sensor
POW-116	Power Supply, 150W,24VDC
SOL-147	Dehumidification Solenoid
SOL-135	Drain Solenoid / Humidity fill
TUB-168	Drain Tubing, Blue, 3/8"
TUB-166	Water Supply Tubing, Blue, 1/4"
ULT-001	Ultrasonic module (7545KIT)

Light Related

Part Number	Description
LGT-214	VIS Detector
LGT-215	UVA Detector
LGT-125	Lamp, UV, Black,115V, each
LGT-126	Lamp, VIS, White,115V, each
LGT-137	Ballast,115V
LGT-141	Ballast,Dimmable,220V
LGT-138	Lamp, UV, Black,220V, each
LGT-139	Lamp, VIS, White,220V, each

Options Related

Part Number	Description	Option
MEM-103	USB Flash Drive	DLOG301
PPR-201	12 inch thermal recorder paper	RCDR203, RCDR204
WIR-102	20/3 conductor shielded wire	ALRM302

LIGHT INTENSITY CHARACTERISTICS (REFERENCE ONLY)

Light intensity nomenclature

	Near UV	Visual
Abbreviation	UVA	VIS
Lamp type	Black	Cool white
Wavelength	320 – 400 nm	400 – 800 nm
Intensity units	W/m ²	lux (or klux)
Exposure (dose) units	W-hr/m ²	lux-hr (or klux-hr)
ICH Q1B confirmatory requirement	200 W-hr/m ²	1.2 million lux-hr or 1200 klux-hr

Photopic (visual light) conversions

1 klux = 92.9 foot-candles (fc)
13.5 $\mu\text{mol}/\text{m}^2/\text{s}$ (for cool white fluorescent only)

Light intensity and lamp age

The life expectancy of a fluorescent lamp varies significantly by the operating condition in which it is used. Under ideal conditions, maximum light intensity decreases with lamp age as shown below. Other factors influencing lamp life includes chamber air temperatures (optimal at 25°C), number of on/off cycles, and amount of light dimming applied. For optimal performance, CARON recommends lamp replacement every 2000 hours.

Optimal Fluorescent Lamp Output

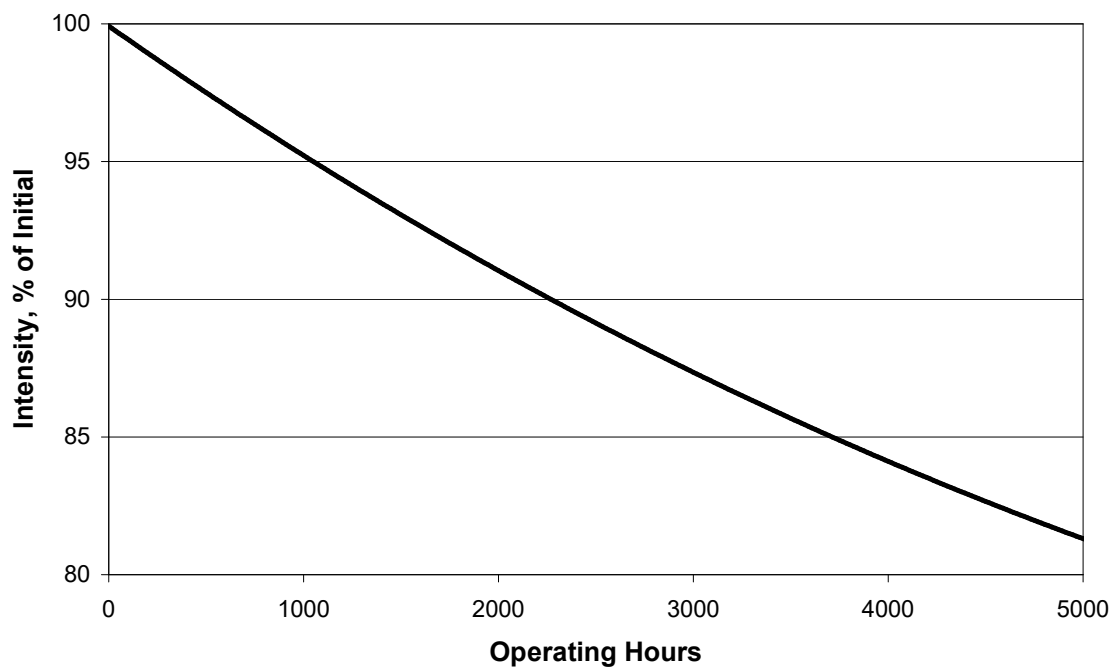

Light intensity versus temperature

The maximum light intensity attainable with the chamber is dependent upon air temperature, lamp age and lamp style. Below 35°C, lower air temperatures constitute lower light intensity levels.

Light Intensity Versus Temperature

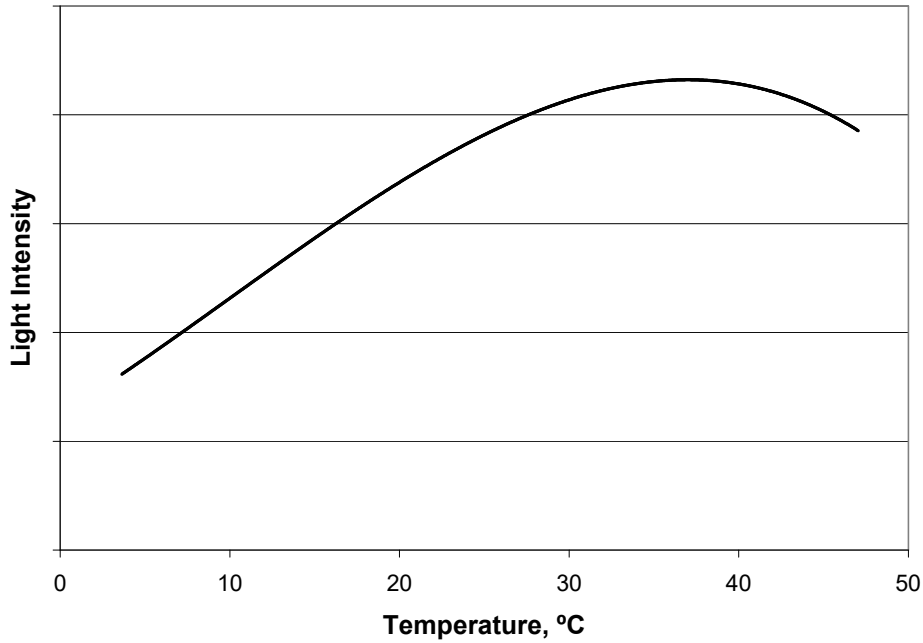

UVA Spectral Power Distribution

A lamp can be characterized by its spectral power distribution (typical output show below). Actual output may vary.

Near-UV Power Spectral Distribution

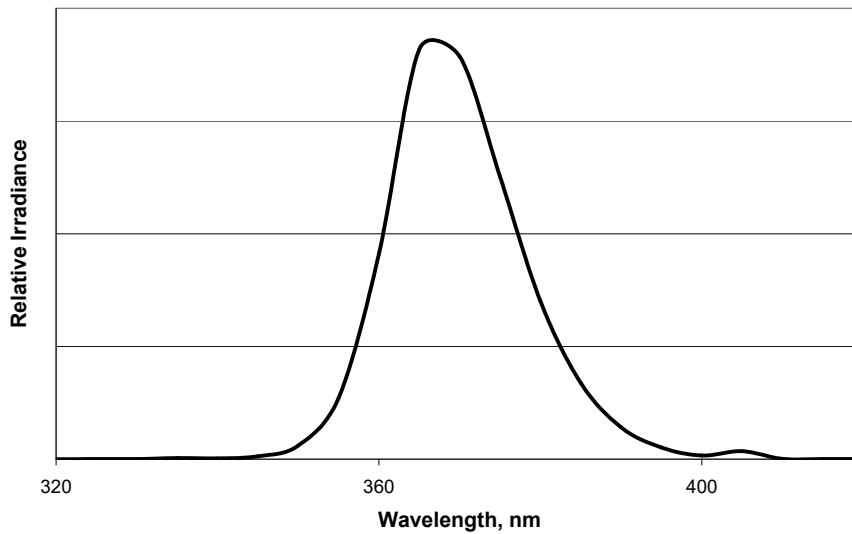

Cool White Spectral Power Distribution

A lamp output can be characterized by its spectral power distribution (typical output show below). Actual output may vary. The cool white lamps conform to ISO 10977.

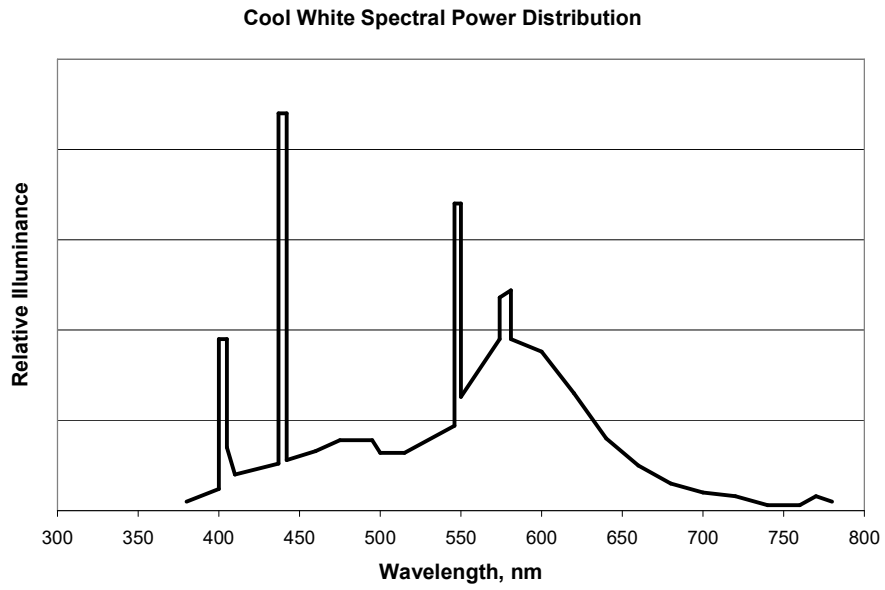



EU DECLARATION OF CONFORMITY

Caron Products and Services, Inc.
27640 State Route 7
Marietta, OH 45750 USA

Declares that the product:

Designation: 7540,7545 Series
Model Numbers: 7540-11-3,7540-11-3
Classification: Electrical equipment intended for residential, commercial and light industrial environments
Rated Voltage: 220-240 ~ (ac)
Rated Frequency: 50/60Hz

Meets the essential requirements of the following European Union Directive(s) using the relevant section(s) of the normalized standards and related documents shown:

Directives: Low Voltage 2014/30/EU, EMC 2014/30/EU, RoHS 2011/65/EU

Standard: IEC 61010-1:2010

Safety requirements for electrical equipment for measurement, control, and laboratory use. Part 1: General Requirements.

Standard: IEC 601010-2-012:2016

Safety requirements for electrical equipment for measurement, control, and laboratory use - Part 2-012: Particular requirements for climatic and environmental testing and other temperature conditioning equipment

Standard: EN 61326-1:2012

Electrical equipment for measurement, control and laboratory use - EMC requirements - Part 1: General requirements

Signed for and on the behalf of Caron.

Date of issue: April 1,2021 in Marietta, OH, USA

By: Bob Dotterer
Engineering Manager, CARON



DECLARATION OF CONFORMITY

Caron Products and Services, Inc.
27640 State Route 7
Marietta, OH 45750 USA

Declares that the product:

Designation: 7540,7545 Series
Model Numbers: 7540-11-3,7540-11-3
Classification: Electrical equipment intended for residential, commercial and light industrial environments
Rated Voltage: 220-240 ~ (ac)
Rated Frequency: 50/60Hz

Meets the essential requirements of the following UK legislation using the relevant section(s) of the UK designated standards and related documents shown:

UK legislation: Electrical Equipment (Safety) 2016, EMC 2016, RoHS 2012

Standard: IEC 61010-1:2010

Safety requirements for electrical equipment for measurement, control, and laboratory use. Part 1: General Requirements.

Standard: IEC 601010-2-012:2016

Safety requirements for electrical equipment for measurement, control, and laboratory use - Part 2-012: Particular requirements for climatic and environmental testing and other temperature conditioning equipment

Standard: EN 61326-1:2012

Electrical equipment for measurement, control and laboratory use - EMC requirements - Part 1: General requirements

Signed for and on the behalf of Caron.

Date of issue: December 30, 2021 in Marietta, OH, USA

By: Bob Dotterer
Engineering Manager, CARON