



CARON PRODUCTS & SERVICES
OPERATIONS MANUAL



LED PLANT GROWTH CHAMBERS

*Models: 7310 -22, 50, 75 / 7311-22, 50, 75
7312-22, 50, 75 / 7314-22, 50, 75 / 7315-22
7317-22, 50, 75*

Dear Valued Customer:

Thank you for purchasing Caron Products & Services equipment. We appreciate your business and look forward to being your preferred supplier of controlled environment equipment products in the future.

At Caron, we are committed to continuous quality improvement. Our goal is to supply our customers with highly reliable equipment at a fair price. In order to openly monitor our performance, we would appreciate your feedback on our products and services.

If you have questions, or any suggestions for improvement based on the installation or operation of the equipment you have purchased, please contact our service department at www.caronproducts.com or 740-373-6809.

Thanks again for your business!

Revision Log

Version	Date	Description
Rev A	07-20-18	Initial release
Rev B	05-14-19	Added analog output adjustable temperature range feature.
Rev C	06-06-19	Added 7315 light sensor location info.
Rev D	09-18-19	Updated Replacement Parts List
Rev E	11-19-19	Added Appendix on Dehumidification
Rev F	1-29-20	Updated for flammable refrigerant
Rev G	10-27-20	Added model 7314-22,50,75
Rev H	01-21-21	Added adjustable alarm delay
Rev I	03-26-21	Changed warranty to 2 years
Rev J	11-10-21	Replaced HUMD312 with HUMD316
Rev K	11-30-21	Updated power requirements and plug connection for -75.

TABLE OF CONTENTS

Warranty	6
Equipment Overview	10
Installation.....	13
Unpacking	
Choosing a Location	
Preliminary Cleaning	
Installing the Port Stoppers	
Installing the Shelves	
Leveling the Unit	
Connecting the Drain Line	
Connecting Electrical Power	
Connecting the Led Lighting	
Optional Accessory Installation	21
Connecting Alarm Contacts (ALRM302)	
Connecting the CO ₂ Supply (CO2C302)	
Connecting the Water Supply (HUMD313, HUMD314, HUMD316)	
Connecting Analog Outputs (OUTP302, OUTP303, OUTP304)	
Installing Drain Water Pump (PUMP301)	
Operation.....	28
Using the Keypad	
Learning the Touch Screen	
Controlling the LED Lighting	
Setting the Light Cycle Timer	
Status of the Light Cycle	
Light Sensor Location	
Changing the Temperature Setpoint	
Changing the Light Setpoint	
Changing the Humidity Setpoint	
Changing the CO ₂ Setpoint	
Optional Accessory Operation	51
Operation of the Data Logging System (DLOG301)	
Operation of Viewing Window (DOOR315, DOOR316, DOOR317)	
Operation of Variable Color Ratio (LGHT331 thru LGHT339)	
Door Light Interior Viewing White Light (LGHT331 thru LGHT339)	
Operation of the Ramp / Soak Control (RAMP301)	
Operation of the Front 6" Mounted Recorders (RCDR316 / RCDR317)	
Operation of the Front 10" Mounted Recorders (RCDR318 / RCDR319)	

Calibration	83
The Calibration Screen	
Calibrating the Temperature	
Calibrating the Humidity	
Calibrating the CO ₂	
Calibrating the Lights	
Calibrating Optional Chart Recorders	
Alarms	90
Alarm System Overview	
Snoozing the Speaker	
Muting the Speaker	
Changing Alarm Setpoints and Delay	
Alerts	97
Alert System Overview	
Resetting the Maintenance Screen	
Info	100
Info System Overview	
Advanced Features	101
Setting the time & day	
Locking the controls	
Changing the passcode	
Factory menu & troubleshooting	
Preventative Maintenance	115
Specifications	117
Electrical Schematics	118
Troubleshooting	128
Spare Replacement Parts	129
Appendix A – Dehumidification Performance	131

WARRANTY INFORMATION

EQUIPMENT LIMITED WARRANTY

Please review this section before requesting warranty service. At Caron, one of our primary goals is to provide customers with high levels of personal service and top quality products, delivered on time, backed by technical service and supported for the life of the product.

Before contacting us for warranty service, please be aware that there are repairs that are not covered under warranty.

WARRANTY DEFINED

Caron Products & Services, Inc. (herein after Caron) hereby warrants that equipment manufactured by Caron is free from defects in materials and workmanship when the equipment is used under normal operating conditions in accordance with the instructions provided by Caron.

COVERED:

- Parts and labor for a period of two (2) year from date of shipment.
- Any part found defective will be either repaired or replaced at Caron's discretion, free of charge, by Caron in Marietta, OH. Parts that are replaced will become the property of Caron.
- If Caron factory service personnel determine that the customer's unit requires further service Caron may, at its sole discretion, provide a service technician to correct the problem, or require the return of the equipment to the factory or authorized service depot.
- Caron will have the right to inspect the equipment and determine the repairs or replacement parts necessary. The customer will be notified, within a reasonable time after inspection, of any costs incurred that are not covered by this warranty prior to initiation of any such repairs.

NOT COVERED:

- Calibration of control parameters.
- Improper installation; including electrical service, gas and water supply tubing, gas supplies, room ventilation, unit leveling, facility structural inadequacies or ambient conditions that are out of specification.
- Cost of express shipment of equipment or parts.
- Any customer modifications of this equipment, or any repairs undertaken without the prior written consent of Caron, will render this limited warranty void.
- Caron is not responsible for consequential, incidental or special damages; whether shipping damage or damages that may occur during transfer to the customer's point of use. When the equipment is signed for at the customer's site, ownership is transferred to the customer. Any damage claims against the shipping company become the responsibility of the customer.
- Repairs necessary because of the equipment being used under other than normal operating conditions or for other than its intended use.
- Repair due to the customer's failure to follow normal maintenance instructions.
- Parts considered consumable; including: light bulbs, filters, gases, etc.
- Damage from use of improper water quality.
- Damage from chemicals or cleaning agents detrimental to equipment materials.
- Force Majeure or Acts of God.

This writing is a final and complete integration of the agreement between Caron and the customer. Caron makes no other warranties, express or implied, of merchantability, fitness for a particular purpose or otherwise, with respect to the goods sold under this agreement. This warranty cannot be altered unless Caron agrees to an alteration in writing and expressly stated herein shall be recognized to vary or modify this contract.

Ohio Law governs this warranty.

EQUIPMENT INTERNATIONAL LIMITED WARRANTY

Please review this section before requesting warranty service. At Caron, one of our primary goals is to provide customers with high levels of personal service and top quality products, delivered on time, backed by technical service and supported for the life of the product.

Before contacting your distributor for warranty service, please be aware that there are repairs that are not covered under warranty.

WARRANTY DEFINED

Caron Products & Services, Inc. (herein after Caron) hereby warrants that equipment manufactured by Caron is free from defects in materials and workmanship when the equipment is used under normal operating conditions in accordance with the instructions provided by Caron.

COVERED:

- Parts for a period of two (2) years from date of shipment.
- Any part found defective will be either repaired or replaced at Caron's or their authorized representative's discretion. Parts that are replaced will become the property of Caron.
- If Caron or their authorized representatives determine that the customer's unit requires further service, Caron or the representative may, at its sole discretion, provide a service technician to correct the problem, or require the return of the equipment to the an authorized service depot.
- Caron or their authorized representative will have the right to inspect the equipment and determine the repairs or replacement parts necessary. The customer will be notified, within a reasonable time after inspection, of any costs incurred that are not covered by this warranty prior to initiation of any such repairs.

NOT COVERED:

- Calibration of control parameters.
- Improper installation; including electrical service, gas and water supply tubing, gas supplies, room ventilation, unit leveling, facility structural inadequacies or ambient conditions that are out of specification.
- Cost of express shipment of equipment or parts.
- Any customer modifications of this equipment, or any repairs undertaken without the prior written consent of Caron, will render this limited warranty void.
- Caron and their representative are not responsible for consequential, incidental or special damages; whether shipping damage or damages that may occur during transfer to the customer's point of use. When the equipment is signed for at the customer's site, ownership is transferred to the customer. Any damage claims against the shipping company become the responsibility of the customer.
- Repairs necessary because of the equipment being used under other than normal operating conditions or for other than its intended use.
- Repair due to the customer's failure to follow normal maintenance instructions.
- Parts considered consumable; including: light bulbs, filters, gases, etc.
- Damage from use of improper water quality.
- Damage from chemicals or cleaning agents detrimental to equipment materials.
- Force Majeure or Acts of God.

This writing is a final and complete integration of the agreement between Caron and the customer. Caron makes no other warranties, express or implied, of merchantability, fitness for a particular purpose or otherwise, with respect to the goods sold under this agreement. This warranty cannot be altered unless Caron agrees to an alteration in writing and expressly stated herein shall be recognized to vary or modify this contract.

Ohio Law governs this warranty.

Caron Products & Services, Inc.
PO Box 715 · Marietta, OH 45750
740-373-6809

INTERNATIONAL SYMBOLS AND DEFINITIONS



Help



Information



Warning of hazardous area



Warning of hot surface



Warning of dangerous electric voltage



Warning of risk of fire



Earth (ground) protective conductor

WARNINGS



Local government may require proper disposal

TO LOCATE REFRIGERANT TYPE AND PRESSURES, SEE SERIAL LABEL LOCATED ON THE OUTSIDE OF THE UNIT

FOR HYDROCARBON (R290 PROPANE) REFRIGERANT UNITS

R290 is highly flammable and must be treated with proper care.



Do not damage the refrigeration circuit. Do not store explosive substances in the unit. Component parts shall be replaced with like components and servicing shall be done by authorized personnel to reduce the risk of possible ignition.



DANGER – Flammable Refrigerant Used. Risk of fire or explosion.

- Do not puncture refrigerant tubing
- Do not use mechanical devices to defrost refrigeration equipment
- Unit to be repaired only by trained service personnel



CAUTION – Flammable Refrigerant Used. Risk of fire or explosion.

- Consult repair manual, owners guide before attempting to service this product. All safety instructions must be followed.
- Dispose of properly in accordance with federal or local regulations.



CAUTION – Do not use any electrical appliance within the Environmental Chamber, other than those recommended by the manufacturer.

EQUIPMENT OVERVIEW

Congratulations! You have just purchased the latest GBrite™ LED Plant Growth Chambers. Before using the equipment, familiarize yourself with key components of the product and thoroughly read this manual.



Model 7312-22

EQUIPMENT OVERVIEW – CONTINUED

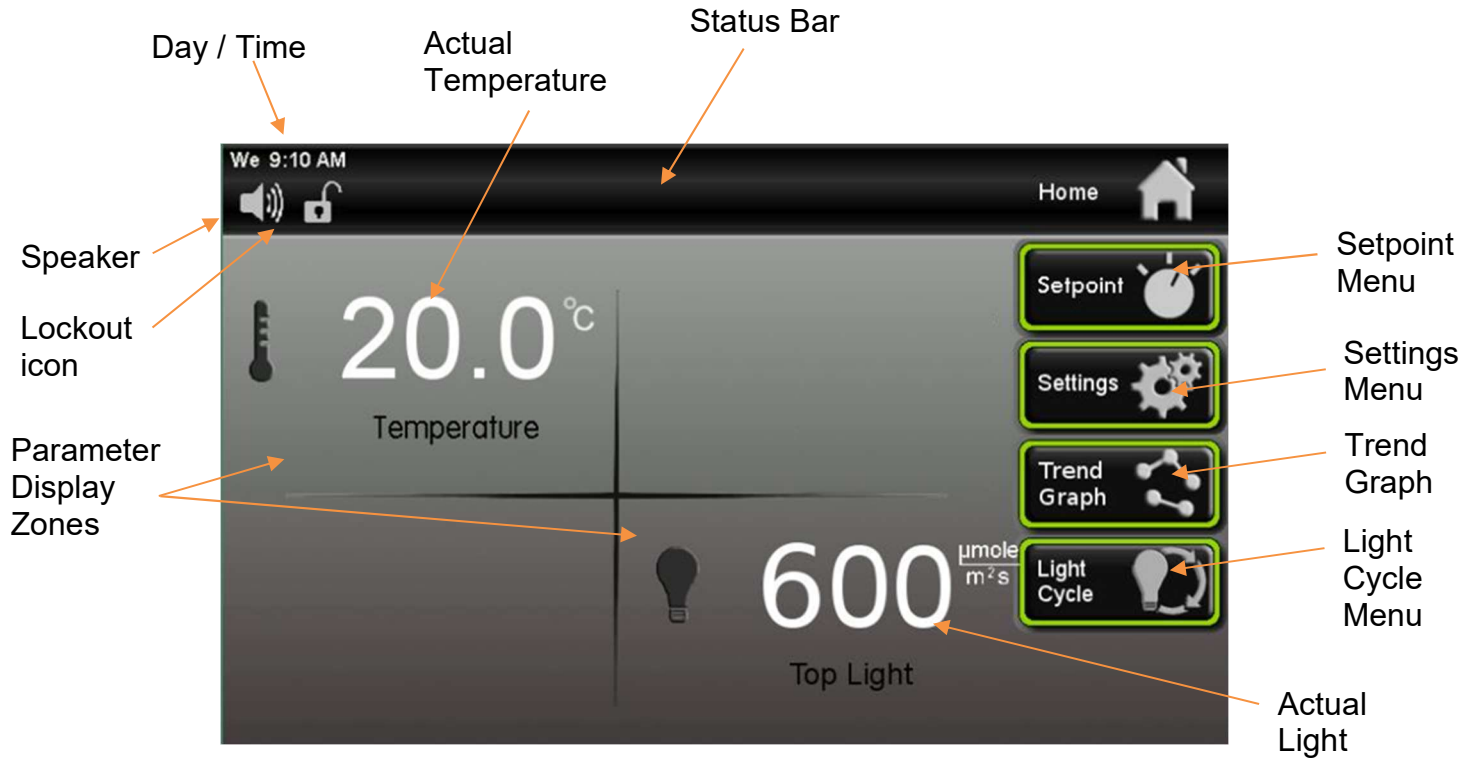

(Home Screen)

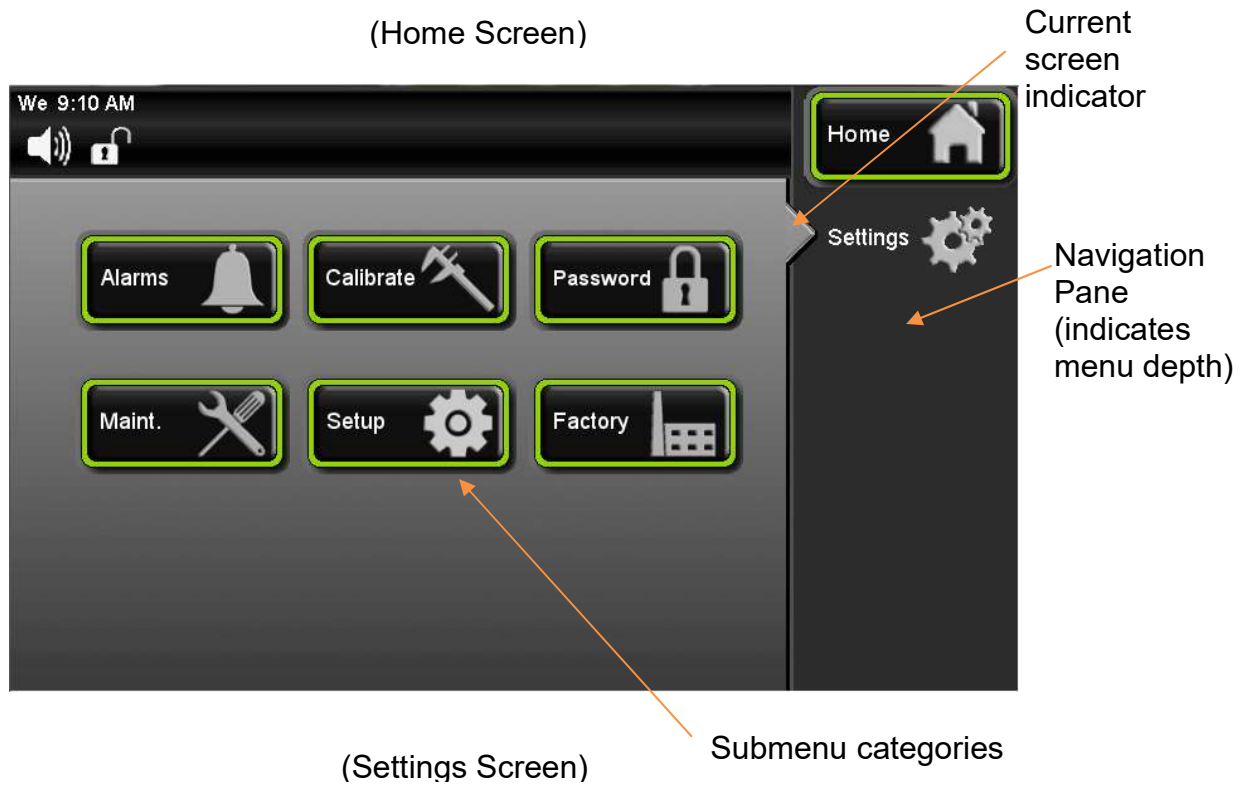

(Settings Screen)

LED Light Banks

The standard units come with white LED lights. If one of the optional light configurations is purchased, it may contain a combination of the 4 colors: red, white, blue and far red (infra-red). Far-red LED light for plant growth is much dimmer than the rest. The human eye can only see to about 700 nm and the far red peaks in the 720-740 nm LED.



LED lights are bright. Avoid looking directly at them. Use protective eye wear or serious eye damage may occur.



White

standard LED light bank

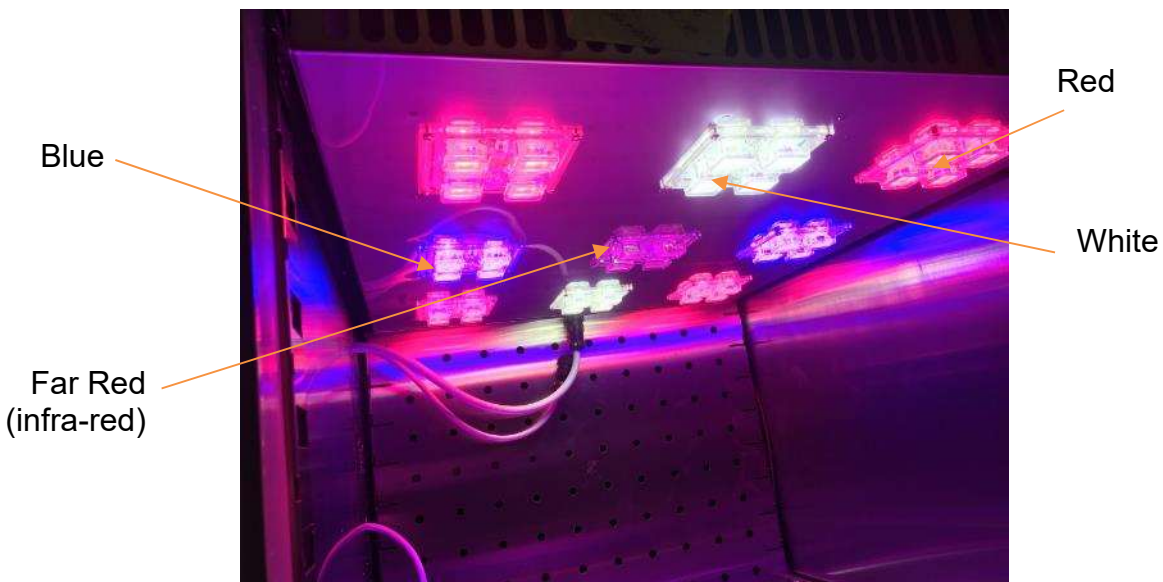

Red

White

Blue

Far Red
(infra-red)

LGHT329 option shown

INSTALLATION

Unpacking

Your new unit has been thoroughly packaged to avoid shipping damage. However, the unit should be fully inspected upon arrival before signing for receipt. If the package has visual damage, notes should be made on the freight bill and signed by the delivery company. In the event of concealed damage after the unit is uncrated, keep the carton and packaging material. Call the shipping company within 7 days of receipt, request inspection and retain a copy of the inspection report.

For prolonged periods of inactivity leave the unit unplugged and properly stored.

Caron provides full on-site installation services for all models. Our installation services guarantees the proper set-up and startup of all equipment. Please contact the Service Department at 740-373-6809 or www.caronproducts.com for details.

For detailed instructions on how to safely remove the chamber off the shipping pallet, see document located on the chamber.

Choosing a Location



This product weighs in excess of 700 pounds. Ensure that sufficient resources are available to safely move the product.

To ensure proper operation, the unit must be located on a firm level surface, capable of supporting approximately 1,000 pounds. The unit should be located in an 18°C – 25°C ambient area and where there is no direct airflow from heating and cooling ducts as well as out of direct sunlight. Allow four inches of clearance on all sides of the product to allow for connections and airflow. The unit is designed to be used under the following conditions:

- Indoor use only
- Altitude up to 2000m.
- Maximum relative humidity: non-condensing
- Mains supply voltage fluctuations up to +/- 10% of the nominal voltage; damage may occur if voltage varies more than 10%
- Transient overvoltages up to the levels of overvoltage category II
- Temporary overvoltages occurring on the mains power supply
- Pollution degree: 2
- Ingress protection: IPXO

Depending on user setpoints, these units may not need a drain. Drains are recommended at temperatures below 15°C. Units with optional humidity control (HUMD312, HUMD313 & HUMD314) need a water source and drain.

The unit requires a dedicated electrical connection. Power requirements vary depending upon the chamber model, see Connecting Electrical Power section.

Choose a location where these facilities are, or can be made available. If a water source or a drain is not available, contact Caron customer service and ask about our CRYS102 product line or click this web link for information on the product:

www.caronproducts.com

Preliminary Cleaning

Your new Plant Growth chamber was thoroughly cleaned prior to leaving the factory. It is recommended, however, to clean all interior surfaces with a general-purpose laboratory cleaning agent to remove any shipping dust or dirt prior to using the product. Contact Caron if there is any doubt of the compatibility of the cleaning agent being used with the chamber. After cleaning, dry all interior components with a sterile cloth as necessary.

Installing the Port Stoppers

The unit has an access port built into each side of the cabinet. The ports are designed to allow customer access for equipment validation and for installation of other equipment inside the chamber. These ports should be sealed with the provided rubber stoppers to allow the chamber to function properly. Install the stoppers provided in the port on each side of the unit.



R290 REFRIGERANT UNITS

DANGER – Flammable Refrigerant Used. Risk of fire or explosion.

- No equipment that uses an open flame should be placed inside the unit.
- Do not use instrumentation or equipment that incorporates potential ignition sources, e.g. open contact switching, brushed DC and AC motors, etc.
- Do not use electrical appliances within the unit, other than those recommended by the manufacturer.

Installing the Shelves

Each new 7310 Series Plant Growth Chamber includes perforated stainless steel shelves. Each shelf requires two shelf channels for installation. The left and right shelf tracks are the same. Prior to installation, take time to consider what the height of the product being placed in the chamber will be and set the shelf spacing accordingly. Additional shelving can be purchased through Caron customer service if necessary. The chamber should be empty when being moved.

To install the shelf channels, insert the rear tab on the shelf channel into the rear wall on the side wall of the chamber. Then insert the front tab into the front pilaster. Push the entire shelf channel towards the rear of the unit and snap it down into place.



Each *empty* shelf is capable of supporting a uniformly distributed load of 50 lbs / 22 kg. Each shelf *which also holds a light bank underneath* is capable of supporting a uniform distributed load of 25 lbs/ 11 kg.



The maximum chamber weight capacity (stationary) is:
180 lbs / 82 kg (1-door),
200 lbs / 91 kg (2-door)
300 lbs / 136 kg (3-door).



Do not have multiple loaded shelves out simultaneously or the chamber may tip.

Leveling the Unit

Place a level on the middle shelf of the incubator. Adjust the feet until the unit sits level left to right and front to back. Even if the unit is level without adjustment, the leveling feet should still be lowered to avoid the cabinet moving while opening and closing the outer door & prevent a flat spot from forming on the casters.



Connecting the Drain Line



When using a pressurized water source, failure to connect the unit to a drain could result in facility flooding.

The chamber drain connection is located in the bottom middle of the back of the chamber. A 3/8" tube fitting and tubing are supplied in the unit parts kit. Slide the tubing into the drain connection. Pull on the tubing after installation to make sure it is tight. Route the drain tubing to a local floor drain.





The drain line relies on gravity to remove water from the chamber. The drain line must remain below the chamber to drain properly. Kinks or elevations in the drain line above the cabinet drain will not allow the chamber to drain.

If a local floor drain is not available, a variety of accessories are available through Caron customer service. These accessories can also be viewed at www.caronproducts.com.

For non-humidified chambers operated above 15°C, a drain is not needed. Install the 1/2” plug into the drain connection.

Connecting Electrical Power



Connect each chamber to a grounded circuit. Failure to do so could result in electrical shock.

The unit requires a dedicated electrical outlet. See table below for model specific power required and connection. This covers 7310, 7311, 7312, 7314, 7315 and 7317 model numbers.

Model #	Power Requirements	Plug Connection
-22-1	115V, 60Hz, 12A FLA	NEMA 5-20
-22-2	230V, 60Hz, 8A FLA	NEMA 6-15
-22-3	230V, 50Hz, 8A FLA	CEE 7/7
-50-2	230V, 60Hz, 12A FLA	NEMA 6-20
-50-3	230V, 50Hz, 12A FLA	CEE 7/7
-75-2	230V, 60Hz, 20A FLA	NEMA L6-30
-75-3	230V, 50Hz, 20A FLA	IEC60309-32A

When the required electrical connection is available, plug the provided power cord into the unit and the electrical outlet.



The mains power supply cord must meet the requirements listed above. The use of an inadequate mains power supply cord could result in equipment failure or personal harm to the user.



In the event of a power outage the unit will automatically restart when the power is restored.

Connecting the LED Lighting

Plant Growth Chambers with LED lighting have light banks consisting of 2,4,9 or 24 LED clusters on each bank. The LED banks are suspended under each shelf. The light banks are shipped fully installed in place and wired from the factory. See the Operations or Maintenance sections of the manual for more details.



Led lights should only be used in a non-condensing environment.



*Model 7312-22 shown with LGHT329 option
Other models may vary*

OPTIONAL ACCESSORY INSTALLATION

Connecting Alarm Contacts (ALRM302)

With the purchase of ALRM302, a set of terminals on the rear of the unit is provided to monitor Temperature, Lights, Humidity (optional), CO₂ (optional) alarms.

With the alarm contacts, the terminals provided allow for a NO (normally open) output, a NC (normally closed) and COM (common) connection. In the event of an alarm condition or power failure, the NO contact will close, and the NC contact will open. Once the alarm is cleared, the contacts return to their normal conditions. Insert the appropriate wire into the terminal and tighten down the screw terminal on top of the connector.

Terminal Connection	Unit off	Normal	Alarm
N/O to C	Closed	Open	Closed
N/C to C	Open	Close	Open

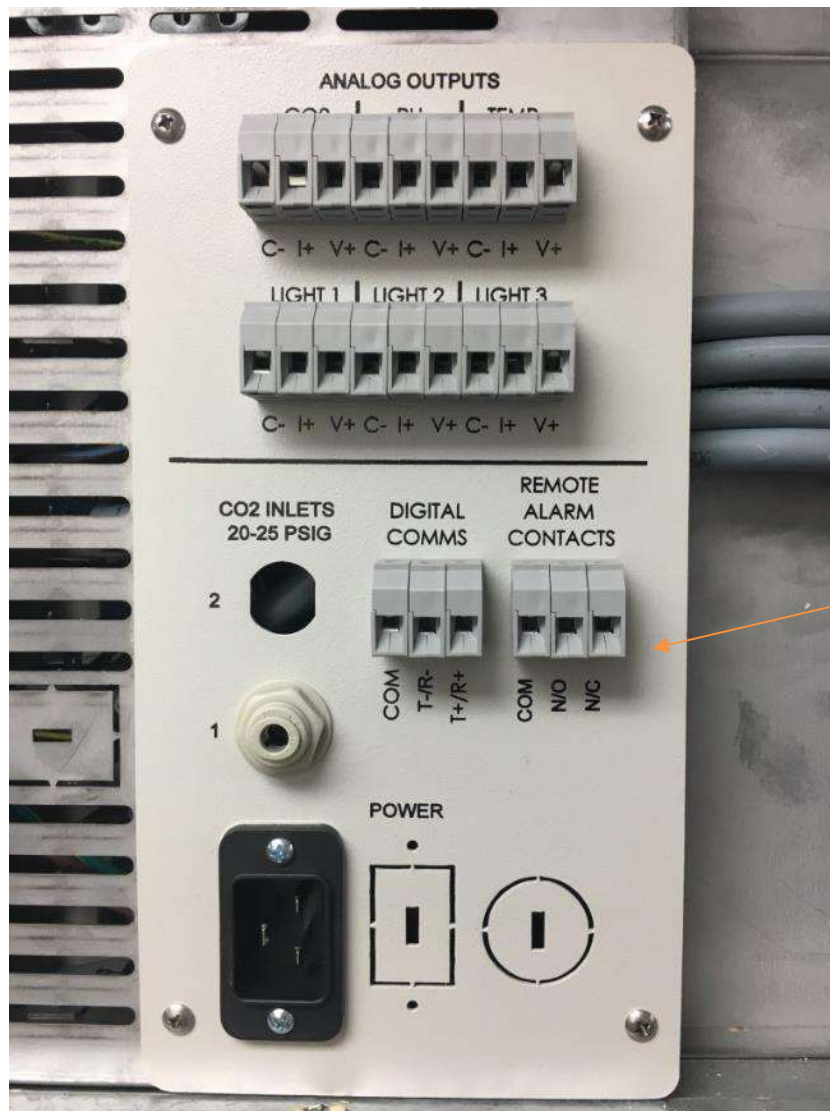

Alarm Contact Connections

Connecting a CO₂ supply (CO2C302)



High concentrations of carbon dioxide can cause asphyxiation. The use of CO₂ monitors and alarms is recommended for areas where CO₂ can collect.



The CO₂ gas supply should be 99% pure and should not contain a siphon tube. Gas pressure to the unit must be regulated to 15-20PSI. Failure to do so could cause tubing to burst.



The CO₂ supply should be 99% and not have siphon tubes. CO₂ pressure should be regulated to 15-20 psi. CO₂ tank regulators can be purchased through Caron customer service. Once the cylinder regulator is installed, connect the outlet of the regulator to the hose barb fitting using the tubing and clamps provided. An inline HEPA filter is provided to remove any contaminants in the CO₂ gas supply. Check the connections closely for leaks.

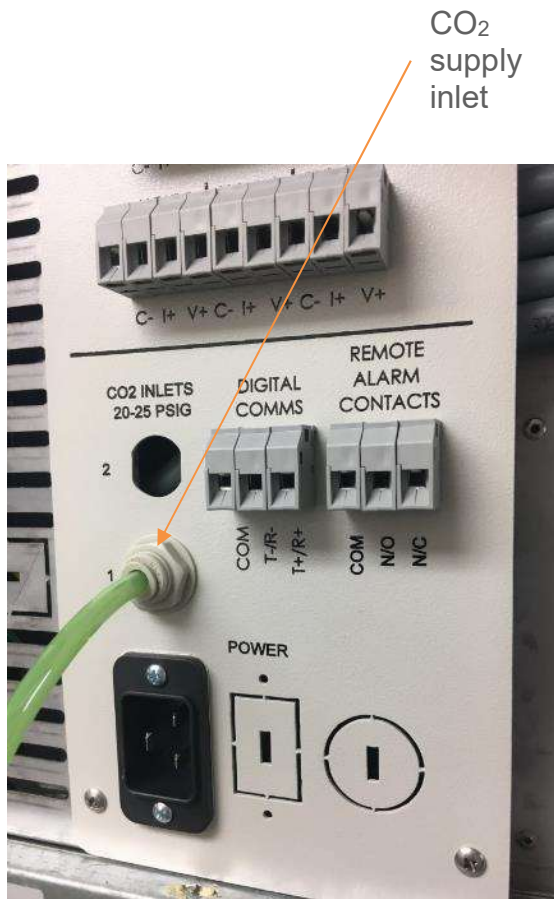

CO₂ supply inlet



CO₂ sample port

Connecting the Water Supply (HUMD313, HUMD314 & HUMD316)

HUMD313, HUMD314, HUMD316 control humidity from ambient to 85%, and dehumidify with ambient air. To ensure proper operation, distilled or deionized water is required as a supply on units that have humidity control. If these water sources are not available contact Caron customer service.



Use only distilled or deionized water with a resistivity between 50KΩ-CM and 1MΩ-CM and a pH of greater than 6.5. Using water outside this range will void your warranty.



Do not use water that contains chloramines. Chloramines can damage internal rubber gaskets resulting in leaks.

A water inlet fitting on the back of the unit and ¼” black tubing is provided to connect the water supply to the chamber. Connect an appropriate water supply to the fitting. Incoming line pressure should be regulated to not exceed 80 psi.

If a Condensate Recirculator water recycling system was purchased as a water supply, refer to its user’s manual for proper installation.



Tubing to water inlet

Connecting Analog Outputs (OUTP302, OUTP303 & OUTP304)

With the purchase of OUTP302, OUTP303, OUTP304, OUTP307, OUTP308 the controls are equipped with analog outputs. A set of terminals are provided on the back of the unit to connect to the analog outputs.

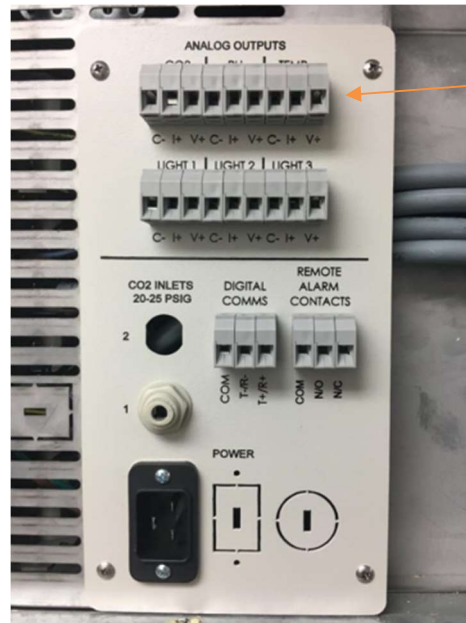

Analog Output Connections

Analog outputs provide either a milliamp (4-20mA) or voltage (0-5V) signal output to represent each of the displayed temperature (and humidity) values. These options can be used for connection to in-house data acquisition, recorder, or alarm system. The temperature parameter (only) is adjustable in its scaling and is accessible at the Analog Output screen.

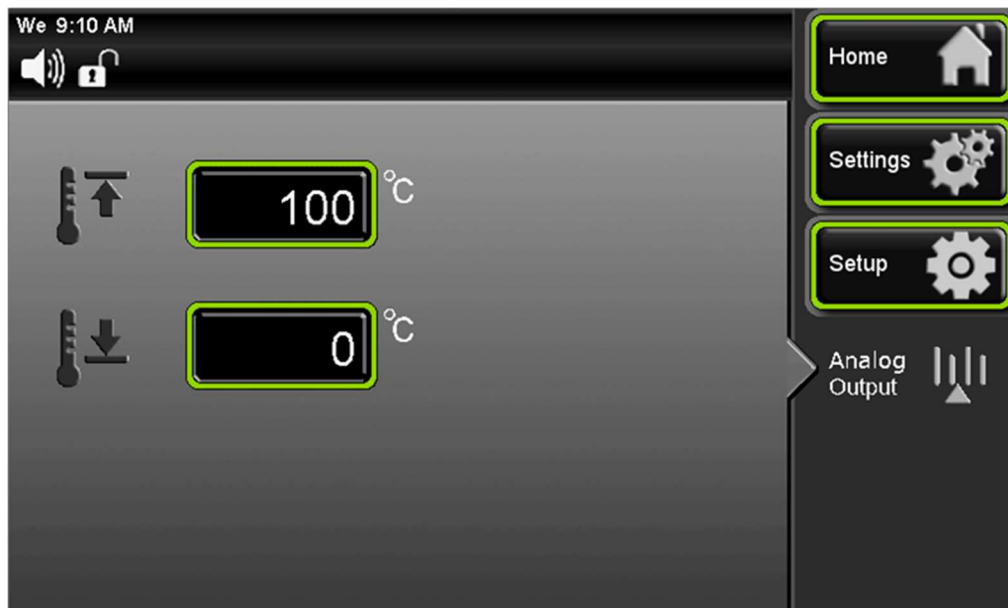

Parameter	Voltage	Current	Corresponding Value
Temperature	0 – 5 V	4-20 mA	-50 – 100 °C (adjustable*)
Lights	0 – 5 V	4-20 mA	150 – 1500 μ moles/m ² /s
Humidity	0 – 5 V	4-20 mA	0 – 100 %RH
CO ₂	0 – 5 V	4-20 mA	0 – 20 %CO ₂

*Default range is -50C to +100C. Temperature scale low range is adjustable from -50C to 0C. Temperature scale high range is adjustable from 1C to 100C.

Connect shielded wires to the appropriate signal terminals: I(+) for current (mA) or V(+) for voltage (DC). For both current and voltage outputs, COM(-) is common terminal

Installing Drain Water Pump (PUMP301)



In applications where a floor drain is not available and a Caron water recycling system is not being used, a drain pump can be purchased to pump any excess condensate from the chamber to a local sink or drain. The pump is located near the middle of the back of the chamber. Connect the supplied tubing from the pump to the sink / drain. The tubing may be run vertically into a ceiling but should not exceed 15 feet height. The pump is equipped with a small reservoir on the bottom of the pump with an internal level switch that will automatically turn the pump ON when it is full to drain the water out of the reservoir and into a floor or sink drain.

OPERATION

Before the unit can be commissioned for use, make sure that the following steps have been completed:

- Chamber is properly installed and level.
- The appropriate utilities connected to the chamber.

With the above-mentioned steps complete, the power switch located on the right side, near the top of the unit exterior, can be turned on.

Within a few minutes, the temperature will begin to approach setpoints. Here is an overview of the home screen.

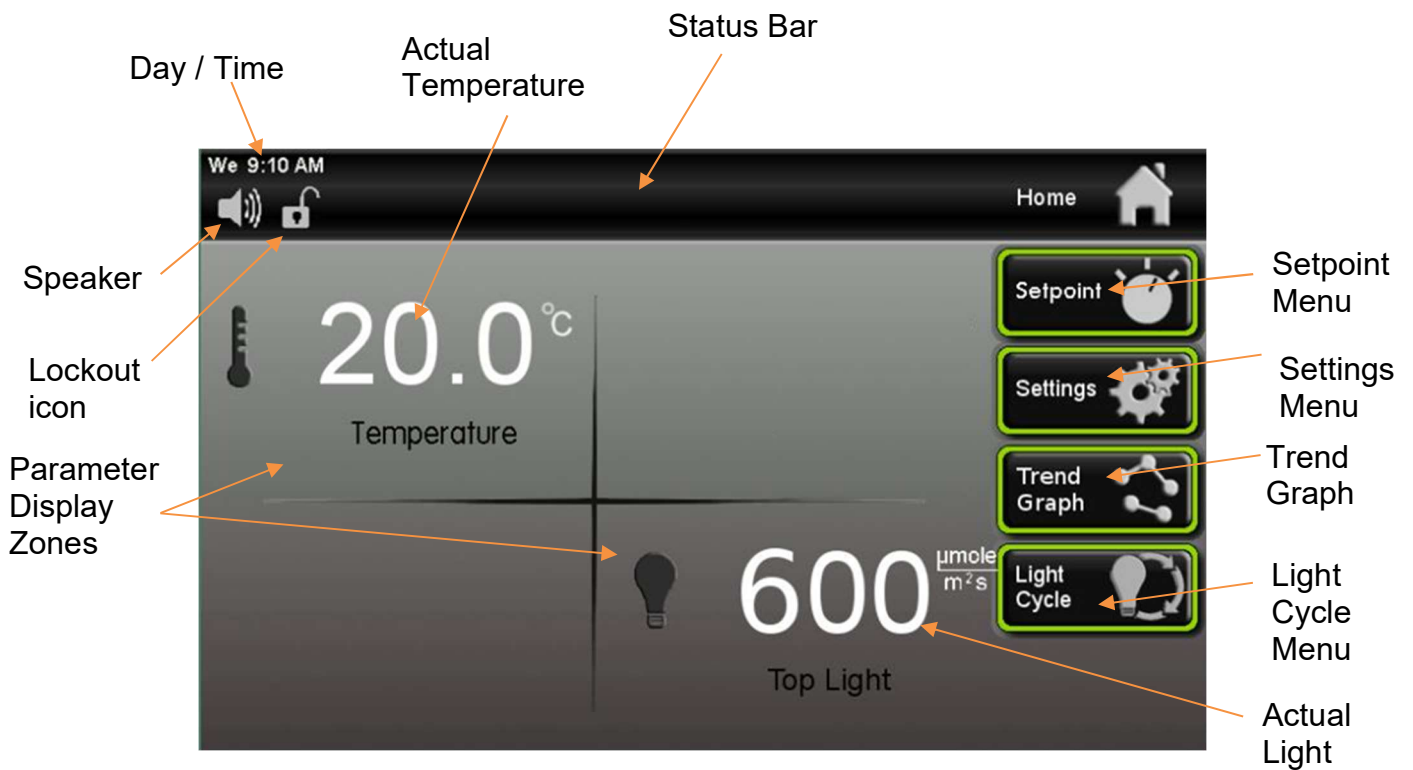

Using the Keypad

This control system uses a numeric keypad to enter all parameter values. Similar to a calculator, this allows quick and precise entry of values. When any numeric value button is pressed, the keypad display will pop up over the current display.

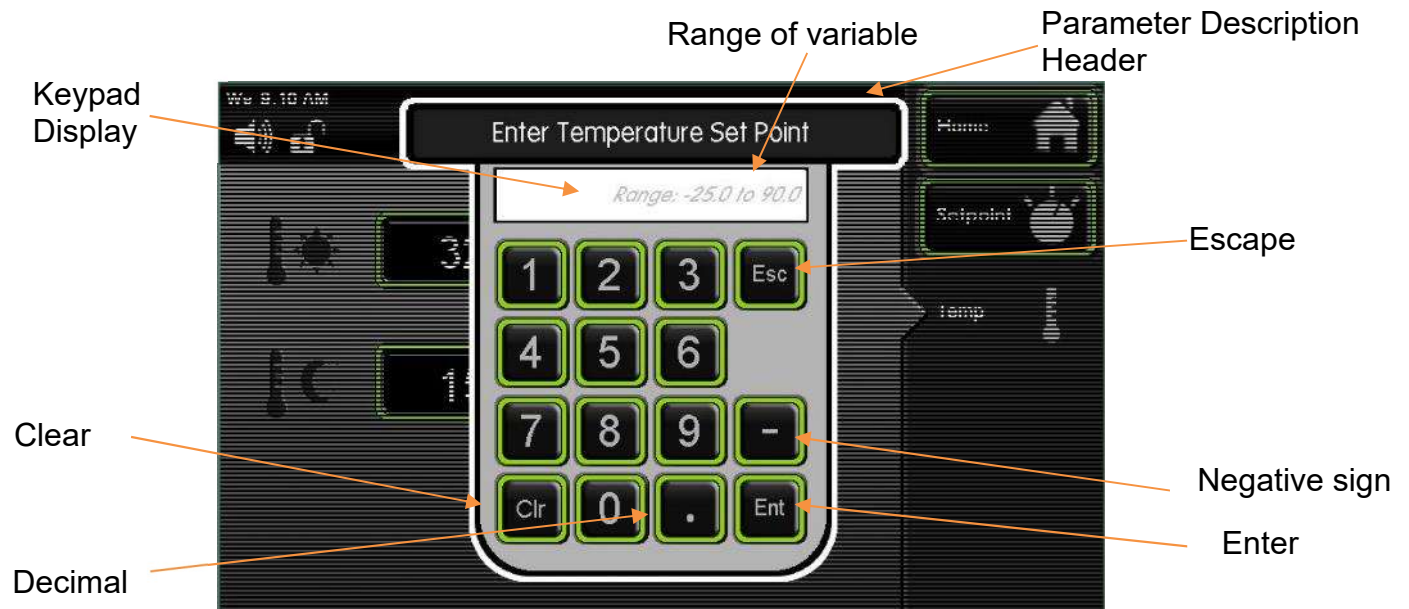

The Parameter Description Header tells what parameter is being changed. The Keypad Display shows allowable values of the parameter being changed (initially) and displays the entered value (when a button is pressed).

The Escape "Esc" button aborts the entry and returns to the previous screen without changing the value. The Clear "Clr" button erases the value that you have entered. After you have entered the value that you want, pressing the Enter "Ent" button and the new value will take affect. This also closes the keypad window. Other keypad buttons include a decimal point button and negative button.

If an invalid numeric button is pressed such that it would create an entry above the parameter's range, the entered number will not display. For example, if the temperature setpoint range is 5.0 to 70.0, pressing '8' followed by an '0', only the '8' will display.

If an invalid entry is made with an entry below the range (such as a '4' followed by the 'Ent' button), then the entry will clear and the range will be re-displayed.

Learning the Touchscreen

To save power and ensure long product life, the touchscreen display has a few features that can be changed to reduce screen brightness and initiate a Screen Saver mode.



High / Low button: high or low screen brightness, preset values.

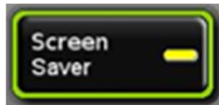

Screen Saver: By pressing the Screen Saver button “on” this will automatically enter screen saver mode after 15 minutes. At this time, the screen will be completely blank (ie. black). The illuminated Caron logo (see Equipment Overview section) shows that the unit is powered on and functioning. To wake-up the touchscreen, simply press anywhere on the touchscreen and the main screen will display. If the unit has an alarm condition, the touchscreen will not go into Screen Saver mode. If an alarm condition occurs while in Screen Saver mode, the display will automatically wake up and display the alarm.

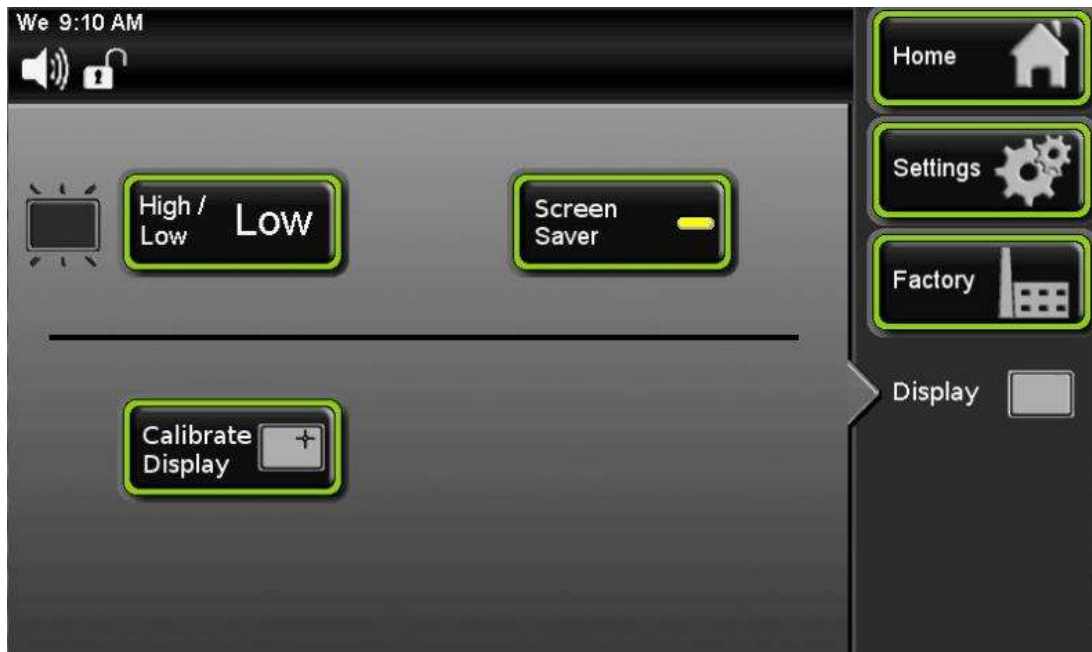

Controlling LED Lighting

The plant growth chamber comes with a Diurnal lighting system used to simulate day and night conditions. The 24 hour cycle that can be programmed with separate temperature and humidity (optional) setpoints that correspond with the “day” (lights on) and “night” (lights off). Setpoints can also be made the same if continuous conditions are needed.

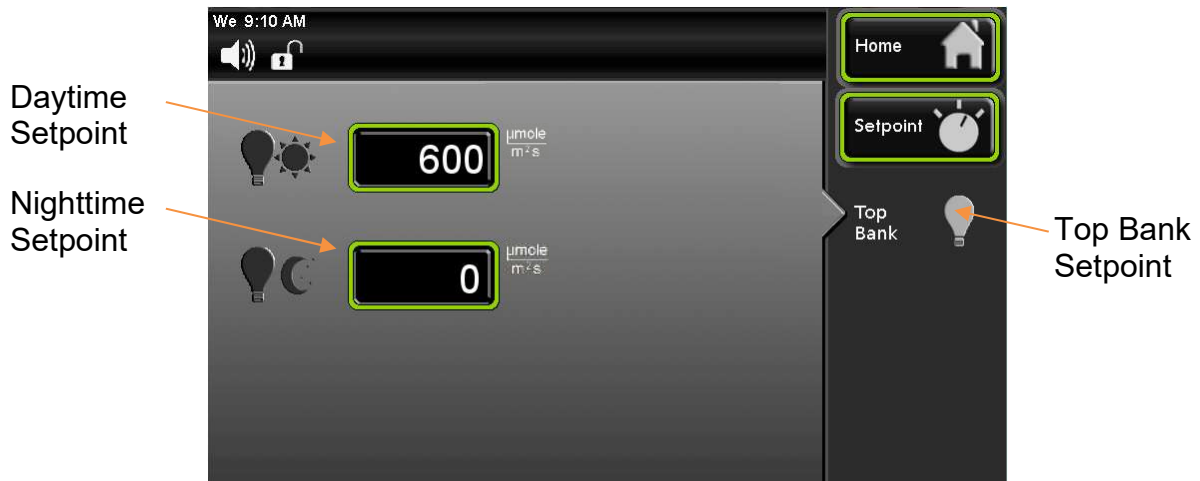
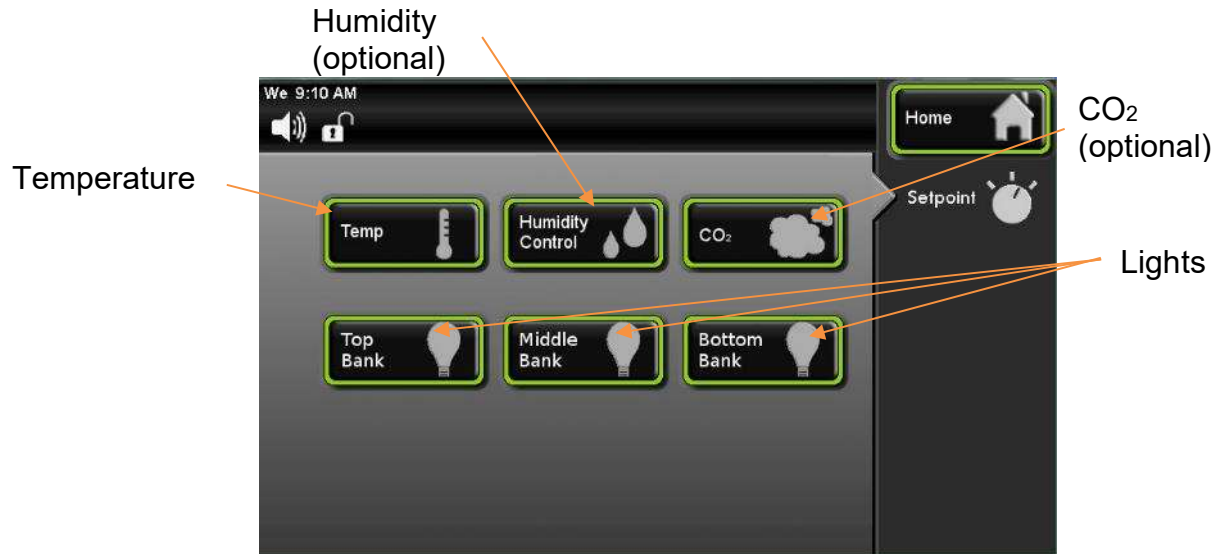

Temperature, Lights, Humidity (option), CO₂ (option) all have Day / Night Setpoint parameters.

Using Light Cycle Features

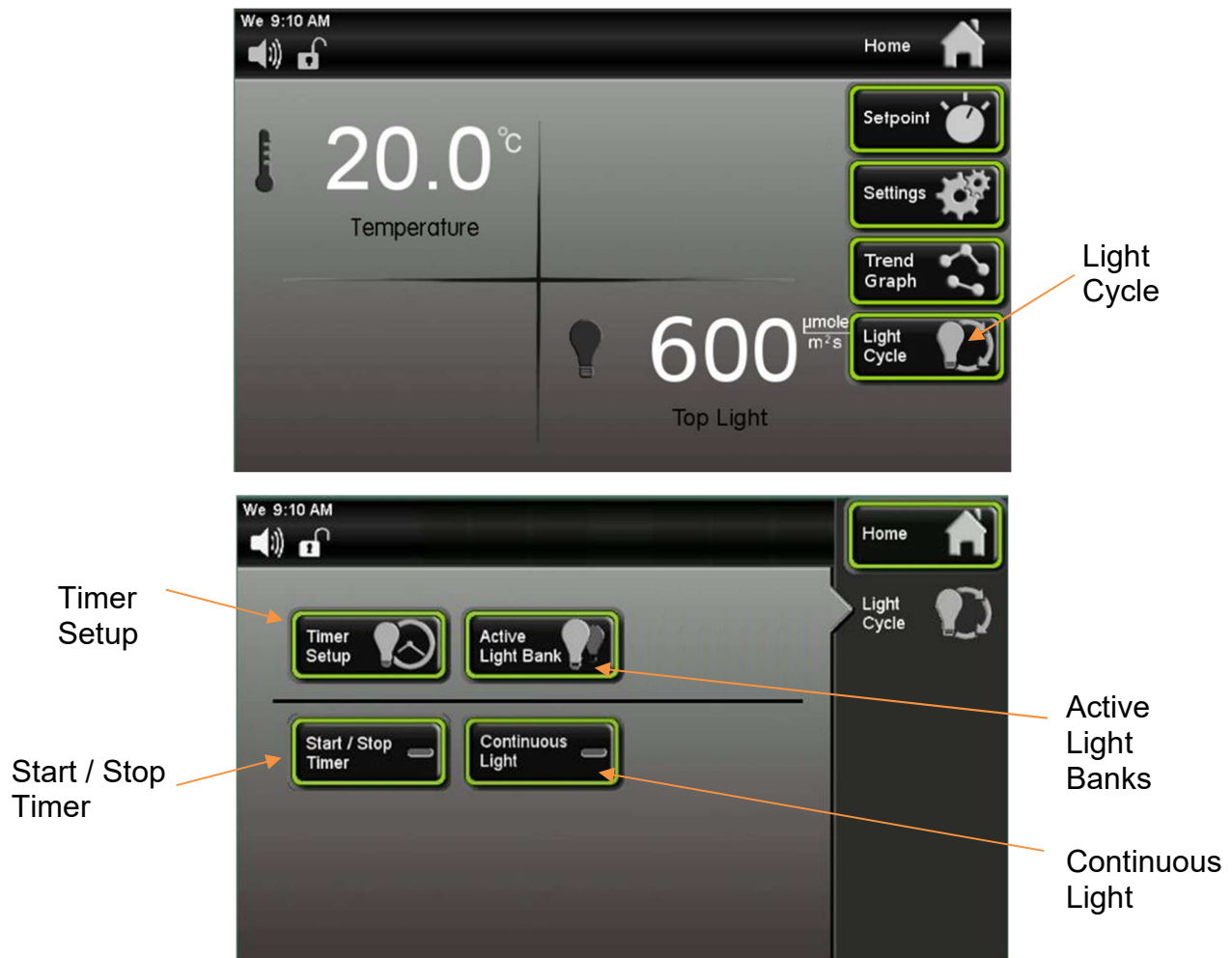

The Light Cycle screen has parameters that can be set up for various conditions.

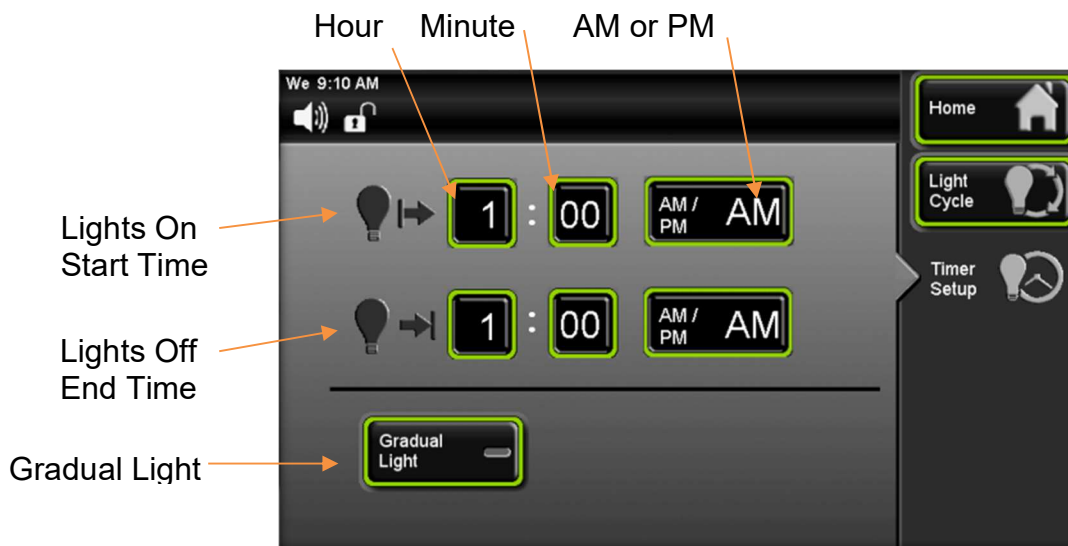

The Timer Setup screen allows users to set up lights “on” start time and lights “off” end time.

The Gradual Light button (option) simulates 30 minutes of sunrise and sunset light conditions.



Light Bank On/ Off



The Active Light Banks (button) lets you choose which light banks you want “on” or “off” during the light cycle. This feature can also be used when the light cycle is setup for Continuous Light and the light timer is not required. (Not available on all models)



Start / Stop Timer

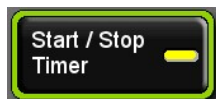

When the Start / Stop Timer (button) is active, the light timer will run the cycle based on the parameters that were set up. An icon appears in the status bar letting the user know that the Light Cycle is running (during this cycle the Continuous Light feature is disabled).

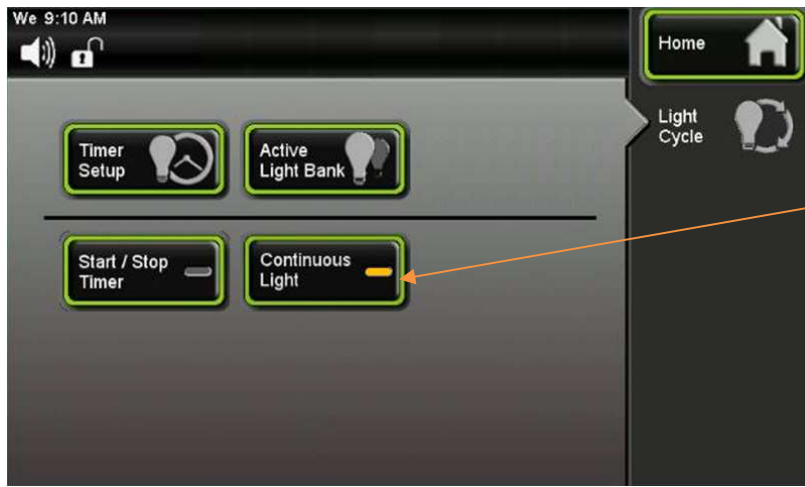

Continuous Light

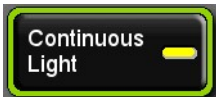

The Continuous Light (button) lets the light banks be on all of the time. When this feature is enabled, the features of the time-based Light Cycle are disabled.

Setting the Light Cycle Timer



Light Cycle Menu

Screen shown with optional humidity



To set the Light Cycle Timer, press the Light Cycle (Light Cycle) button on the right side of the screen.



press the  (Timer Setup) button on the left side of the screen.

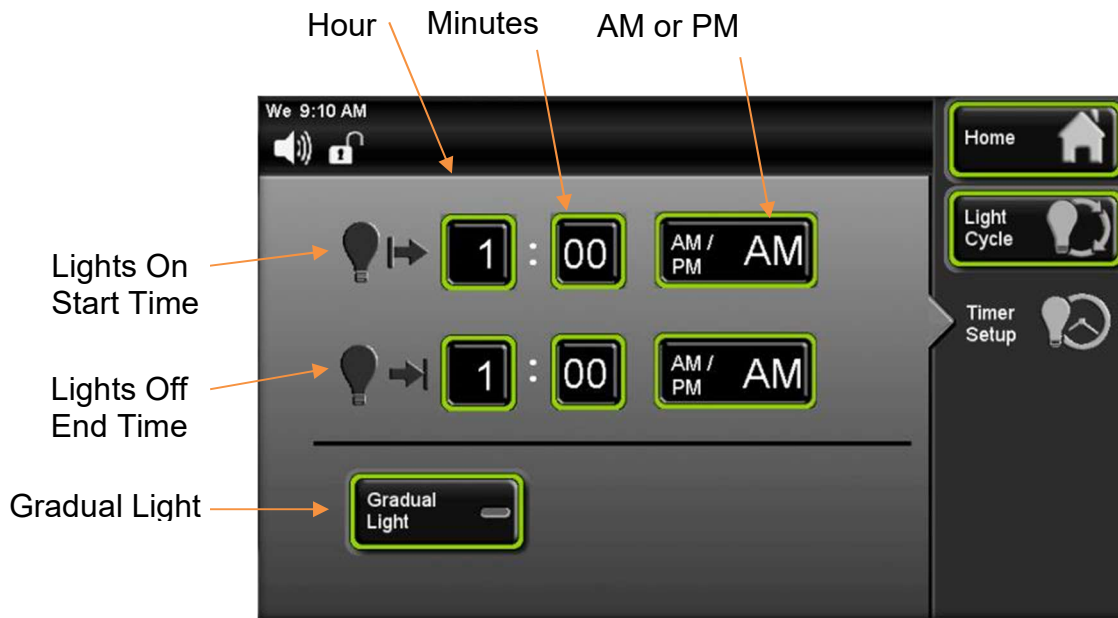

Press the Lights On Start Time hour button and the enter the hour that you want the lights to come on. Finish by pressing  (Ent) key.

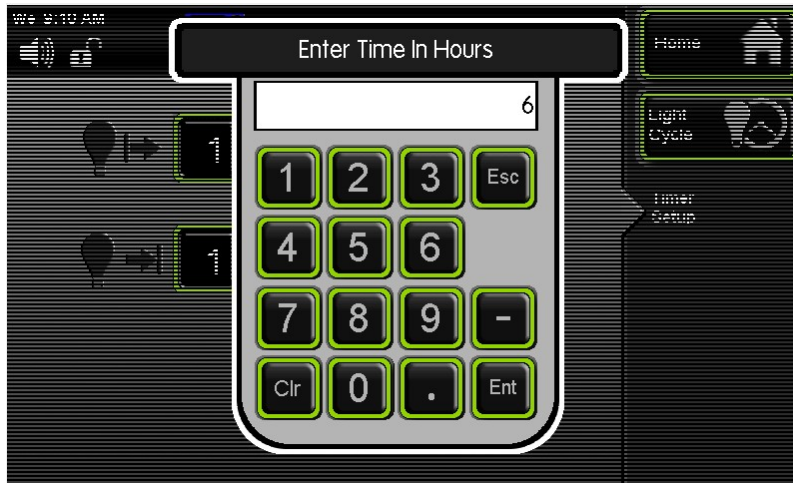

Then press the “minutes” button to set the minutes parameter.



To setup AM/ PM, Press (AM /PM) button and the words for AM and PM will toggle back and forth.

Repeat process for setting up Lights Off End Time.

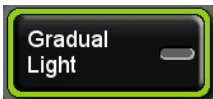

Select Gradual Light button to simulate sunrise and sunset light conditions. (optional)



Go back to the previous screen by pressing (Light Cycle) button.





From this screen press the **Active Light Bank** (button). This feature is only available on chambers with multiple independent light banks, and screen appearance will vary depending on set up.



Select which light banks are to be on during the light cycle. At least one light bank must be selected before navigating away from this page.



Go back to the previous screen by pressing **Light Cycle** (Light Cycle) button.

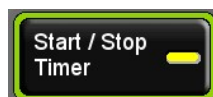

To activate the Light Cycle Timer press the **Start / Stop Timer** (Start / Stop Timer) button.

Light Cycle Status

The Light Cycle is programmed to automatically change lights, temperature and humidity (optional) over a 24 hour period. The Light Cycle Info screen is intended to provide a comprehensive visual illustration of the Light Cycle settings and current conditions.

When the Light Cycle is on, the status of the cycle time can be displayed by pressing the Light Cycle icon that is in the Status Bar.

Light Cycle



The Light Cycle Info screen displays information regarding the light cycle, start time, end time, light banks etc. This icon is only displayed in the Status Bar when the Light Timer is active and during the “lights on” time.

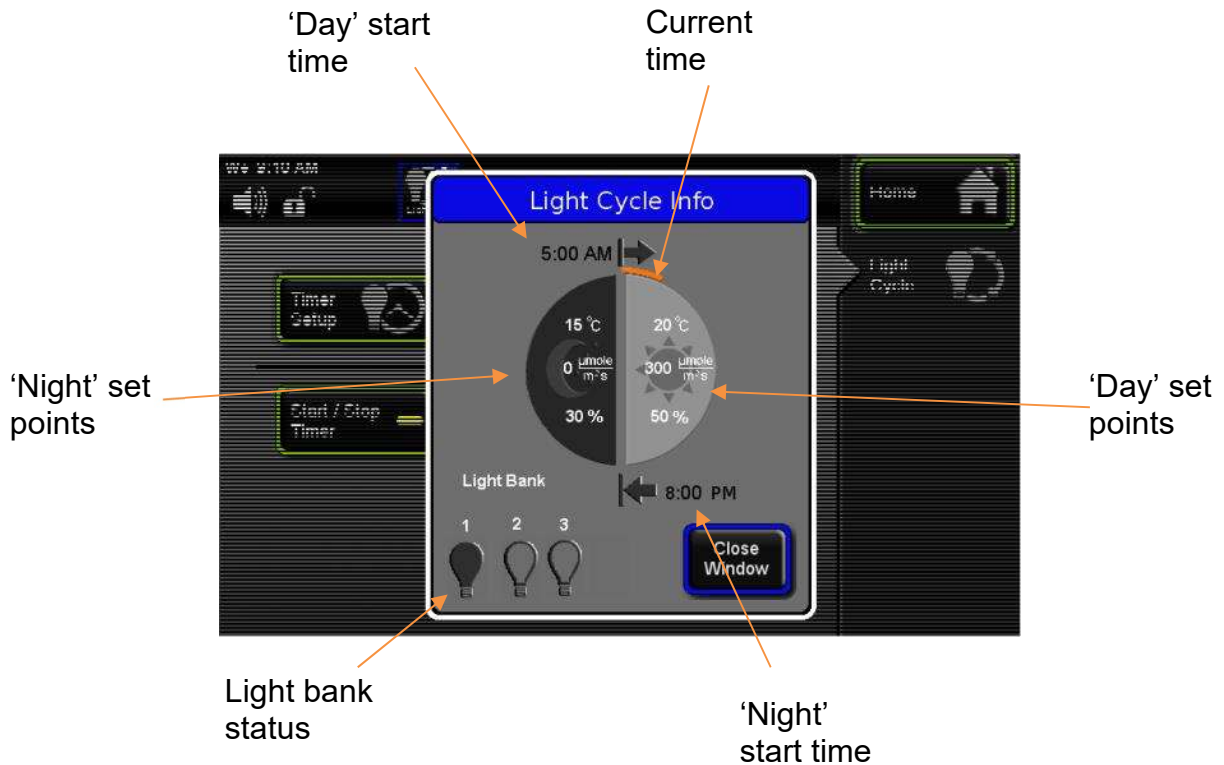

When Light Cycle is active the  Light Cycle Info icon appears in the Status Bar. Press this icon button and Light Cycle Info screen will appear displaying information about the Light Cycle including current time.

To return to the home screen press the  Close Window button, or wait 15 seconds and the screen will return to the home screen.

Light Sensor Location

The light intensity specification is measured from 6 inches away from LED's and with all white lights.



Moving the light sensor to another location the lights may not reach the programmed light intensity setpoint.

7315-22 Light Sensor Location

The light sensor on models 7315-22 Tissue Culture have a specific location on the duct sheet of the chamber. Light intensities were tested with the light sensor at this location which is for normal operations of the chamber.



If the light sensor needs to be moved for other tests, this “home” location for the sensor is indicated by the green dot on the back of the light sensor bracket which corresponds to the green dot on the duct sheet.



To maintain the correct light intensity, the light sensor has to be positioned in the 1st row of holes directly under the light bank and 2 holes to the right of the light bank power cable. As shown below.



Changing the Temperature Setpoint

The steps below walk through an example of changing the temperature setpoint from 30.0 °C to 20.0 °C. This example shows (optional) humidity control and CO₂. Here is the Home Screen display.



To set the temperature setpoint, press the  (Setpoint) button on the right side of the screen.

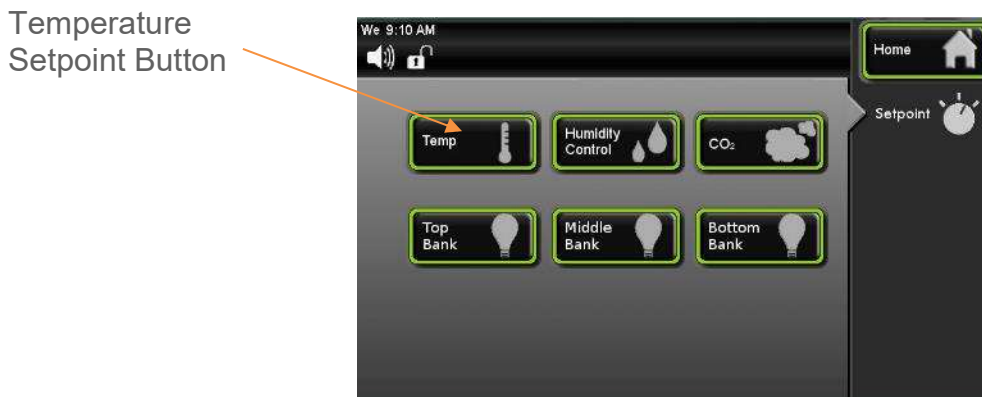

On Plant Growth Chambers there is a Daytime and Nighttime Temperature setting



30.0

Press the (Temperature Setpoint) button. (In this example the temperature setpoint initially has a value of '30.0'; this will vary with different initial setpoint values.)

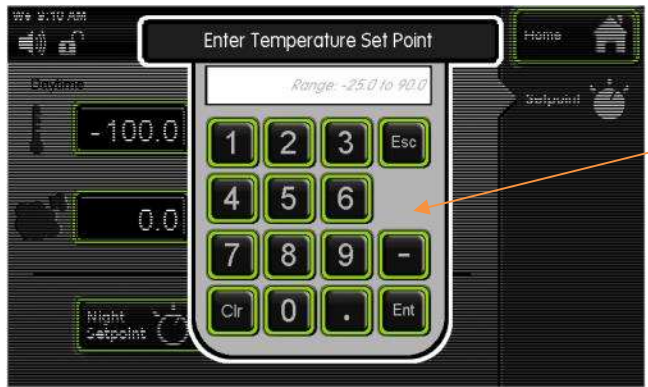

Keypad

A temperature setpoint window will appear. Enter the temperature setpoint by using the

keypad. For a setpoint of 20, press (‘2’), then (‘0’), followed by the

(Enter) key. Correct any mistakes with the (Clear button) and reenter the value. Once the Enter key has been pressed, the pop-up keypad disappears and the screen returns to the Setpoint display with the new value of 20.0 in the temperature set point button.

To change the parameters for the Nighttime setpoints, press the Night Setpoint button and repeat same steps for Changing Temperature Setpoint

Home

Press the (Home) button to return to the main screen.

Changing the Light Setpoint

The steps below walk through an example of changing the light setpoint to 600 $\mu\text{mol}/\text{m}^2\text{s}$. This example shows (optional) humidity control and CO₂. Here is the Home Screen display.

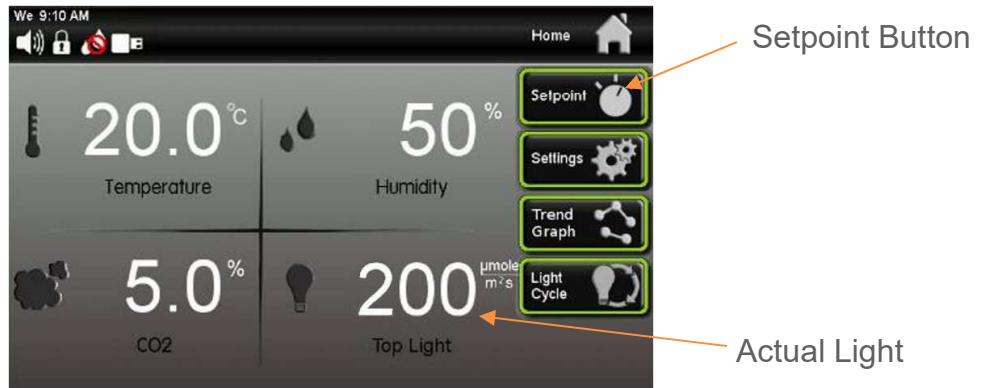

To set the light setpoint, press the  (Setpoint) button on the right side of the screen.

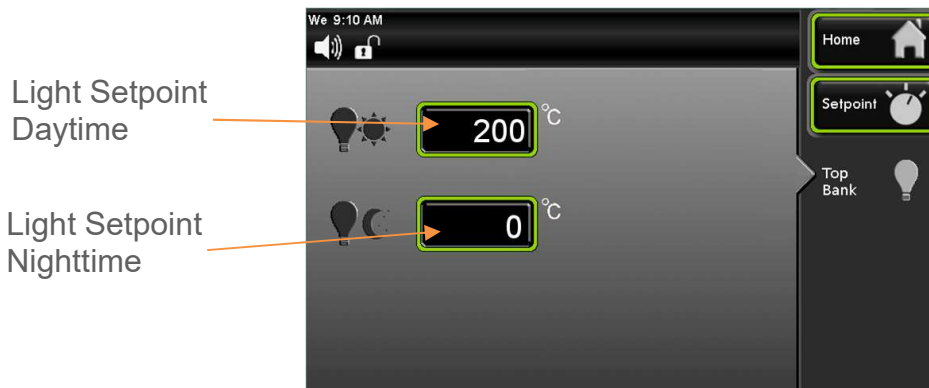
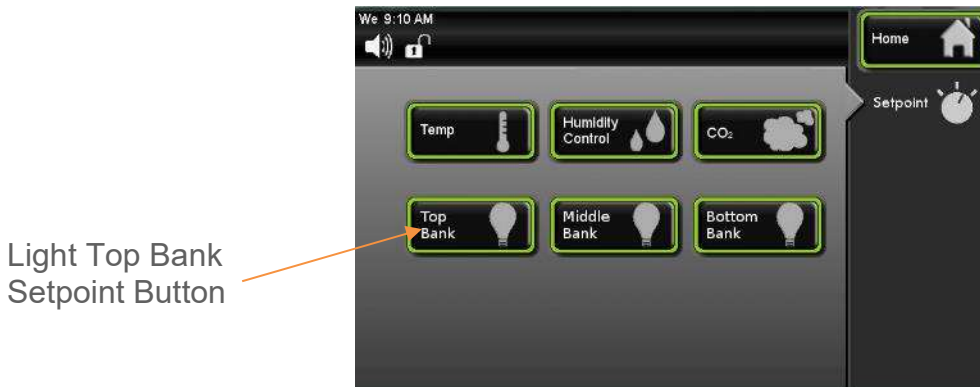

Once the setpoint screen appears, press the  (Light Setpoint Daytime) button.

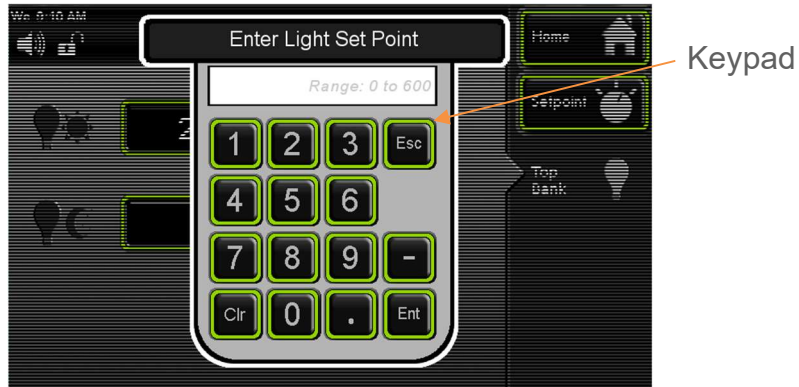

Enter the new light setpoint on the keypad as desired and press  (Enter) when complete.

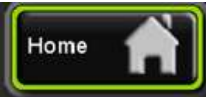

Press the  (Home) button to return to the main screen.

If light bank setpoint is set too low beyond the low range of the LED lights, this low-level dimming value is approximately (10%-15%), the lights will stay on at the minimum dimming level.

The info button will appear in the Status Bar.



This Info pop up window is informing the user that the setpoint value that has been entered exceeds the lowest amount of light that the lights can be dimmed.

**Note: Lights may dim as low as (10%-15%) of their maximum value but not turn off completely.*



Changing the Humidity Setpoint (HUMD312, HUMD313 & HUMD314 only)

The steps below walk through an example of changing the humidity setpoint. Here is the Home Screen display.

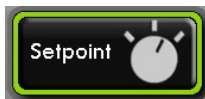
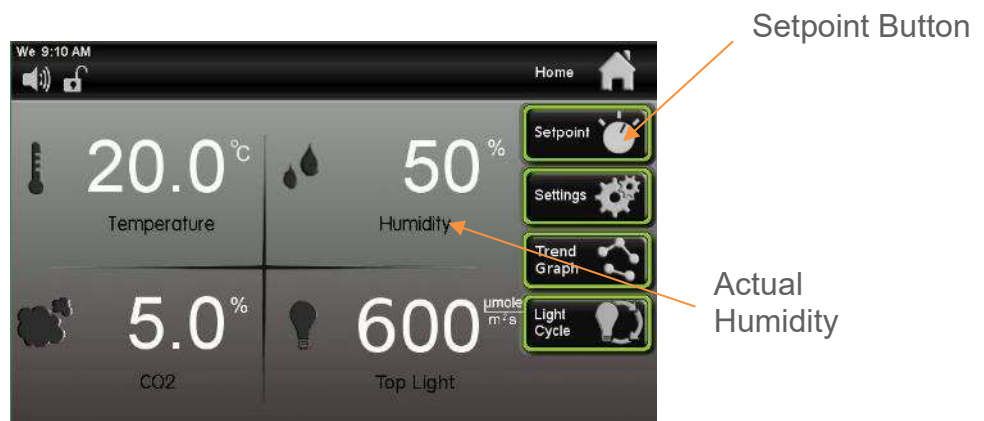

Press the (Setpoint) button on the right side of the screen.

Humidity
Setpoint Button

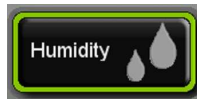
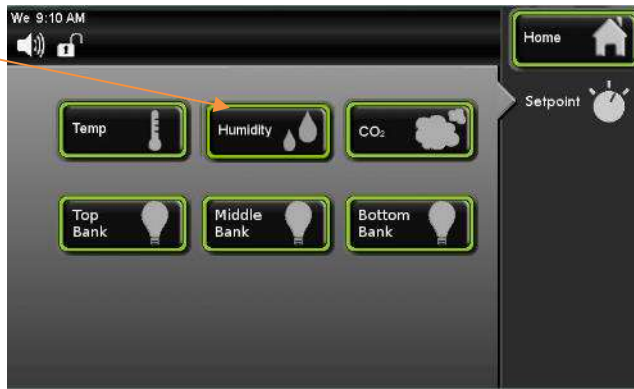

To set the humidity setpoint, press the  (Humidity) button.



Once the setpoint screen appears, press the  (Humidity setpoint) button.

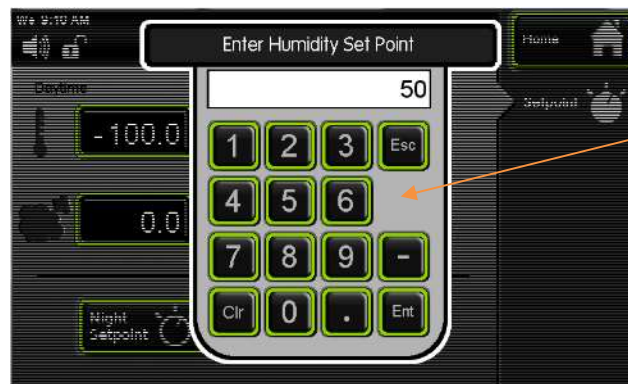

Keypad



Enter the new humidity setpoint on the keypad as desired and press  (Enter) when complete.



Home Button

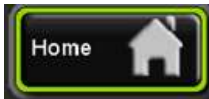

Press the (Home) button to return to the main screen.

Changing the CO₂ Setpoint (CO2C302)

The steps below walk through an example of changing the CO₂ setpoint. Here is the Home Screen display.



Setpoint Button

Actual CO₂



Press the (Setpoint) button on the right side of the screen.



CO₂ Setpoint Button

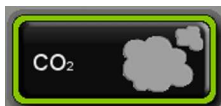

To set the CO₂ setpoint, press the (CO₂) button.

CO₂ Setpoint Button

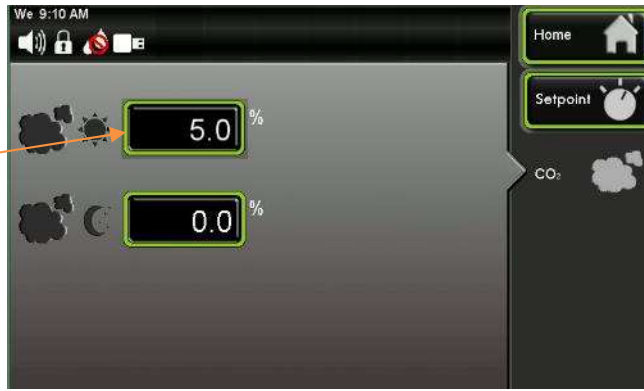

Once the setpoint screen appears, press the  (CO₂ Setpoint) button.

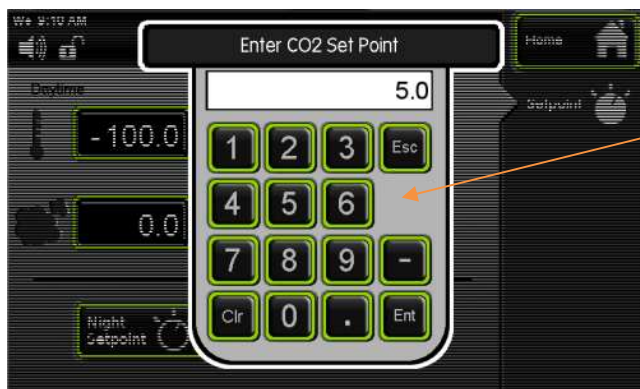

Keypad



Enter the new CO₂ setpoint on the keypad as desired and press  (Enter) when complete.



Press the  (Home) button to return to the main screen.

OPTIONAL ACCESSORY OPERATION

Operation of the Data Logger (DLOG301)



The DLOG301 option provides the customer with a means of logging data electronically for viewing at a later date. Logged variables are Temperature, Humidity, CO₂ and Light Intensity (but only if the chamber is equipped with those features.) All data is time-stamped with year, month, day of the month, hour, minute, 24 hour time (ISO 8601 format). This data is stored internally in the chamber in non-volatile memory.

Note: The date and time are logged within the actual file name. The file's "Date modified" field is not maintained and therefore may not reflect the actual date and time the file was created.

Data is logged every 5 minutes (provided the chamber is on); more than 10 years of data can be stored in memory. If the internal memory fills up, new data overwrites the oldest data.



Continuous writing to the flash drive necessitates a high quality industrial grade device. Use only the flash drive provided by Caron (or equivalent: single level cell memory, wear leveling algorithms, error correcting code).



File name format is "DATE START YYYY-MM-DDTHH-MM_ .csv" (hours in 24 hour time)

When the chamber is on, the chamber's history data is being stored even when a flash drive is ***not*** inserted in the USB port. This data may be retrieved anytime using the provided USB flash drive.

Here are the methods for retrieving data:

Continuous logging of data

Insert the flash drive into the chamber's USB port. When first inserted, it creates a .csv file called 'DATA START' with the current date and time in the file name. At 5 min intervals, the chamber's process values are appended to the file. (The file will get as large as the flash drive, permitting several years of uninterrupted data storage.)



USB icon appears in in Status bar indicating that data is being written to flash drive. To retrieve the data press the 'Eject' button, then insert the flash drive into a computer to upload the data.

Upon re-insertion of the flash drive, a new .csv file is created, even if the old file is still present. File name nomenclature is "DATE START YYYY-MM-DDTHH-MM_.csv".

History Retrieval



Select the 'Auto Export' feature on the USB menu screen. Insert the flash drive into the chamber's USB port. A new .csv file is automatically created on the flash drive with all the stored history data.

The file name nomenclature is "DATE END YYYY-MM-DDTHH-MM_.csv".



There is also an 'All Data' feature to indicate if the upload should include all data (since the unit has been used) or just the history data since a flash drive was last inserted. An 'Info' button will appear in the status bar warning the user not to remove the flash drive while the data is being uploaded. The length of time to upload the file will depend on the file size. When the 'Info' button disappears from the status bar, press the 'Eject' button to safely remove the flash drive. Now the data can be uploaded to a computer for viewing.

When using the Continuous Logging of Data method, nothing on the touchscreen has to be setup. However using the History Retrieval method will require going into the USB screen to select either the 'Auto Export' or 'All Data' buttons before inserting flash drive into USB port.

To select the 'Auto Export' and 'All Data' buttons.

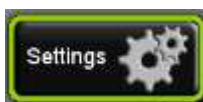

Press the  (Settings) button.



Setup Button

Press the  (Setup) button.



USB Button

Press the  (USB) button.



When the 'Auto Export'  button is selected this will retrieve the data starting at the point of the last download, and continuing to the present time.



When the 'All Data' button is selected this will retrieve data starting at the point of the last download, and continuing to the present time.

USB flash drive icon



Info button

Eject button

When flash drive is inserted into the USB port a 'USB flash drive' icon and flashing 'Info' button appears in the status bar indicating that the data is being downloaded to the flash drive.

Once 'Info' icon stops flashing select the 'Eject' button.

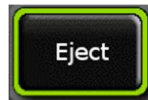

Wait until the USB icon disappears to safely remove the flash drive from the USB port.

Note: Press the Eject button before removing the flash drive from the chamber, otherwise there could be the risk of corrupt data.

Here is a graphic to illustrate how the data retrieval works.

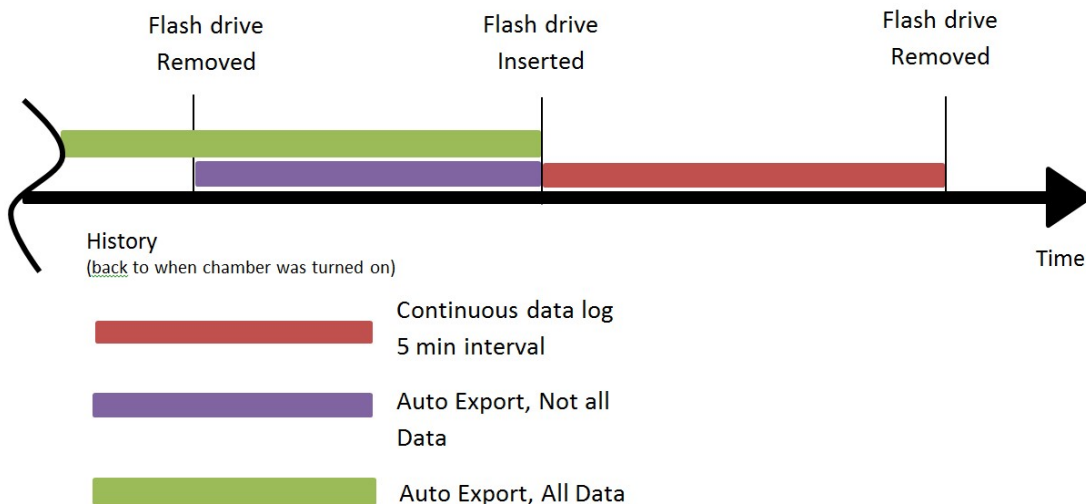

Operation of the Viewing Window (DOOR315, DOOR316, DOOR317)

All models of 7310 series -22 -50 -75 can all have their solid doors replaced with the feature of an optional viewing window.

This option allows the samples to be viewed without opening the door and disturbing the temperature, lights, humidity and CO₂ control.



*Model 7312-22
shown with option DOOR315*

Operation of Variable Color Light Control (LGHT331 thru LGHT339)

The optional Variable Color Light Control feature allows independent lighting control of up to four different light colors: White, Blue, Red and Far Red. The relative light intensity of these can vary per light bank or chamber section.

Independent lighting control works by using the same 'overall' Light Intensity Setpoint as described earlier under the Setpoint and Light Bank menus. The color Light Ratios allow users to precisely vary the distribution of light between White/Blue/Red/Far Red spectra. The Light Ratio is in terms of a percentage, **not light intensity**, but rather a comparison among the White/Blue/Red/Far Red lights.

The default output for each color being on is 100%.

Light Ratio:

If all Light Ratios are set to the same number, the lights will all exhibit the same output percentage (for a given set point). If all Light Ratios are set to 5% the light will be the same as all ratios being 75% or 100%.

If ratios are a multiple of each other, they will exhibit the same output amount (for a given set point).

Condition: Light Ratios

- If the Light Ratios are set: 5% white, 8% blue, 12% red, 2% far red. The light distribution will be the same as all ratios being 10% white, 16% blue, 24% red, 4% far red, or as 40% white, 64% blue, 96% red, 16% far red.

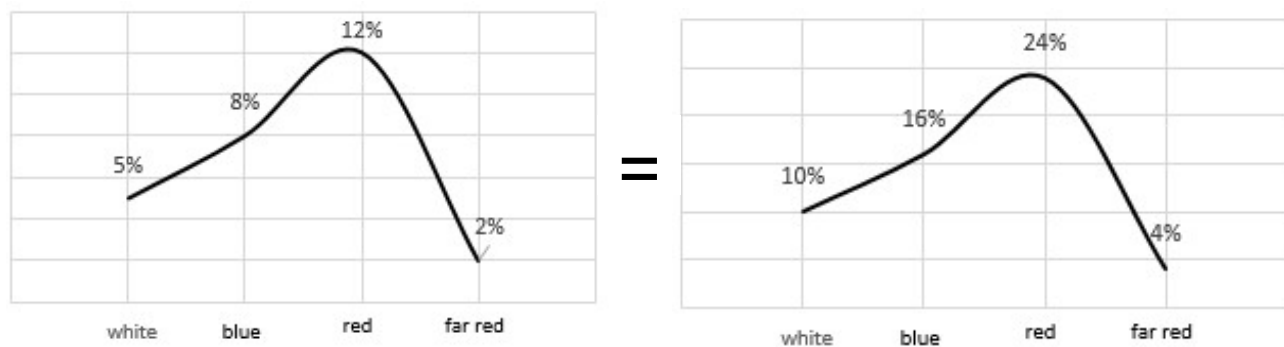

Low Light Ratio:

The Light Intensity Setpoint may not be reached if the Light Ratios are generally set too low.

The 'Minimum dimming level' may engage in low light output situation preventing a color from dimming further.

Note: Not all Light Ratio combinations are actually attainable with this equipment due to high or low Light Intensity Setpoints and/ or Light Ratio values.

Condition: Low Light Ratio

- If the Light Ratios are set at 5% white, 5% blue, 5% red, 100% far red, it would be expected that a Light Intensity Setpoint of 600 umoles/m²/s would not be attainable with light from predominantly far-red lighting.

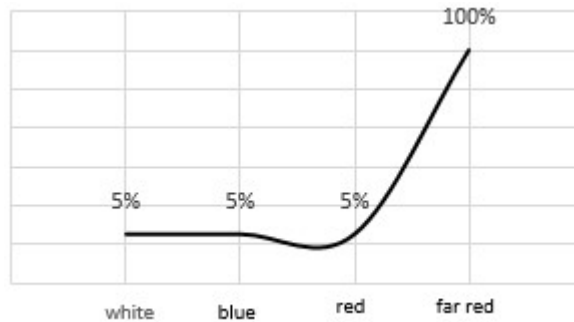

- If the Light Ratios are set at: 100% white, 1% blue, 100% red, 100% far red, it would be expected that blue's setting of 1% would encounter the minimum dimming level situation.

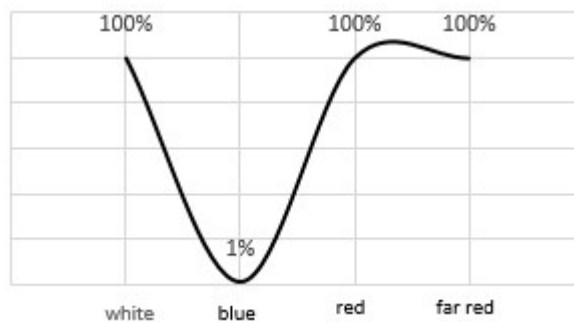

**Note: Lights may dim as low as 10% of their maximum value but not turn off completely. Model 7315 will dim as low as 15%.*

Some Light Ratios that are set too low and fall below the minimum output. When this occurs An alarm will appear stating that Light Intensity Low.

Light Ratios can also be adjusted too high and can cause an alarm status. The Light Intensity Setpoint value can be set to a high value and if the Light Ratio values are too low, the light bank will never reach the specified Light Intensity Setpoint.

If the Light Intensity Setpoint is set at a lower value, and the Light Ratio values are set at high percentage output, An alarm could occur indicating the unit cannot reach the lower Light Intensity Setpoint because the Light Ratio values are too high.



Light Cycle Menu

Screen shown with optional humidity



To set the Light Cycle, press the  (Light Cycle) button on the right side of the screen.



Ratio Menu



The Ratio Menu  (button) allows the user to change each color ratio of a light bank (optional feature).

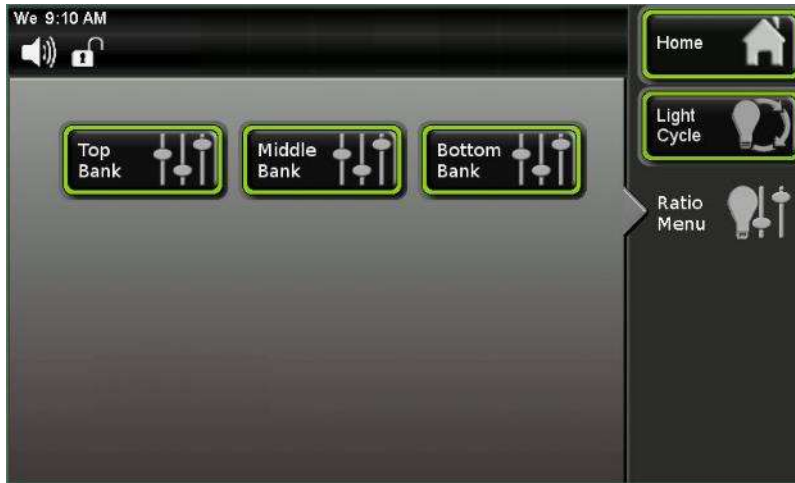

Selecting the Top Bank (button) will open a screen where you can adjust the intensity of each of the 4 colors of LED clusters.

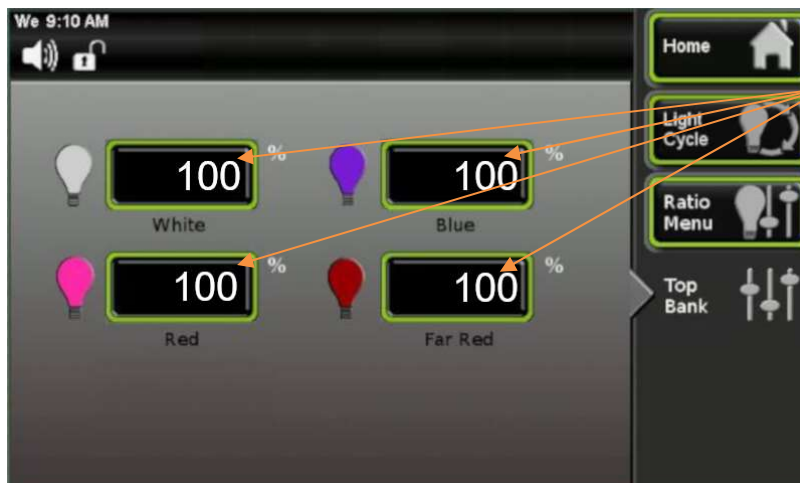

Light Intensity Ratio %



Press one of the 4 color Intensity Ratio Entry buttons .



Enter value using keypad, finish by pressing  (Ent) key.

Repeat for other color intensities. Press Ratio Menu button to change other light banks.



After programming the specified setpoints and settings, the lighting will adjust according to the specified Light Intensity Setpoint. After 15 mins have passed, if there is no alarm on the screen then the Light Intensity Setpoints and Light Ratio values are within an acceptable range.

If there is a Light Intensity Alarm on the screen you will have to change one or more of the following parameters:

- Light Intensity Setpoint: setpoint value too high, or too low.
- Light Ratios: If changed from default value of 100%, values may need to be increased or decreased.
- Light Setpoint Alarm: value too close to actual Light Intensity Setpoint.

Below are examples of Light Intensity Setpoints and the results when Light Ratio values are set at 100% and output values other than 100%.

Example 1 shows the Light Intensity Setpoint set to 600 umoles/m²/s. All 4 colored light ratios are set to 100%.

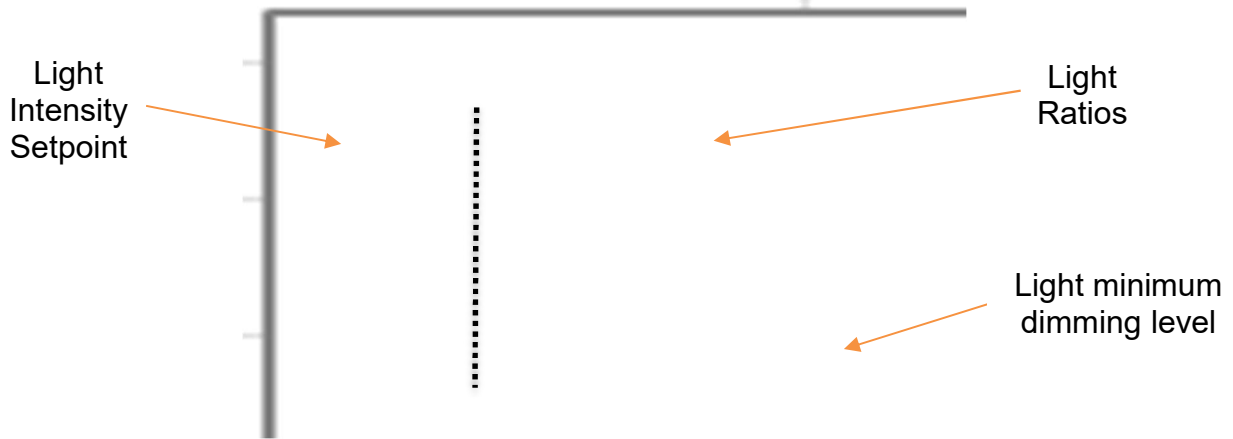

Example 1

Example 2 shows the Light Intensity Setpoint set to 300 umoles/m²/s. All 4 colored light ratios are set to 100%.

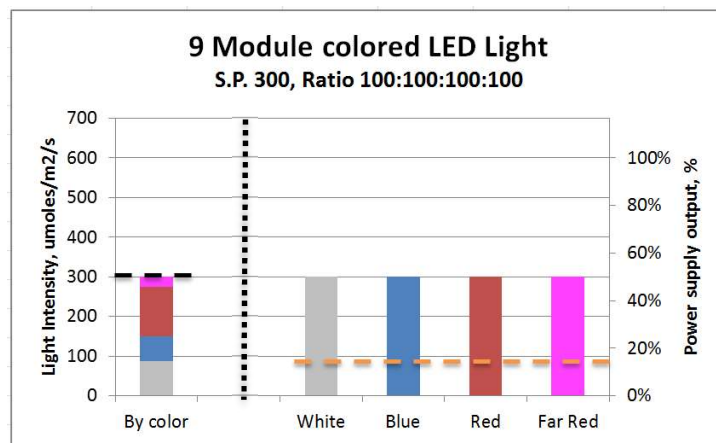

Example 2

Example 3 shows the Light Intensity Setpoint set to 50 umoles/m²/s. All 4 colored light ratios are set to 100%.some

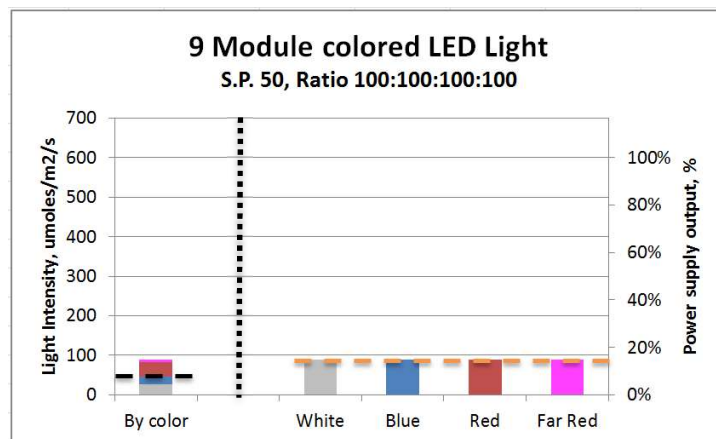

Example 3

Example 3 will alarm due to the Light Ratio values are set too high for a Light Intensity Setpoint of a lower value.

Example 4 shows the Light Intensity Setpoint set to 200 umoles/m²/s. White 0%, Blue 28%, Red 50%, Far Red 15%.

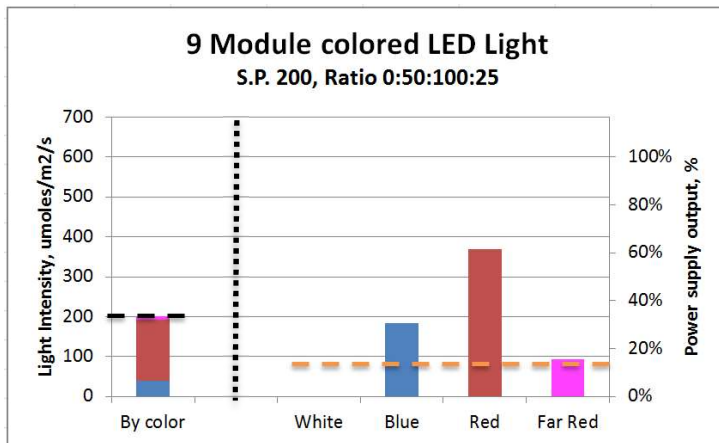

Example 4

Example 5 shows the Light Intensity Setpoint set to 600 umoles/m²/s. White 0%, Blue 50%, Red 100%, Far Red 25%.

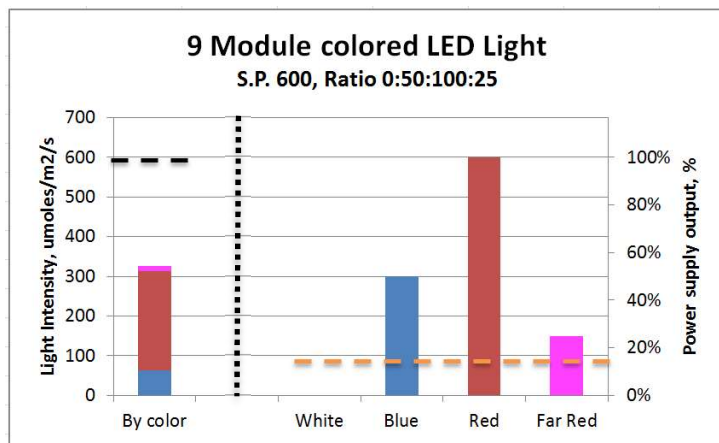

Example 5

Example 6 shows the Light Intensity Setpoint set to 75 umoles/m²/s. White 0%, Blue 28%, Red 50%, Far Red 15%.

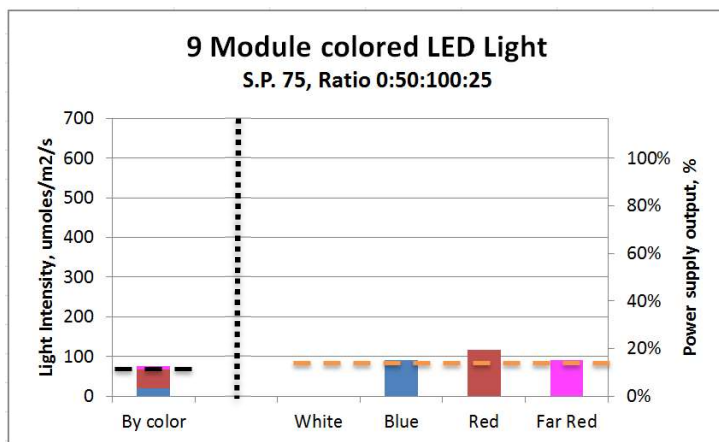

Example 6

Example 7 shows the Light Intensity Setpoint set to 50 umoles/m²/s. White 0%, Blue 50%, Red 100%, Far Red 25%.

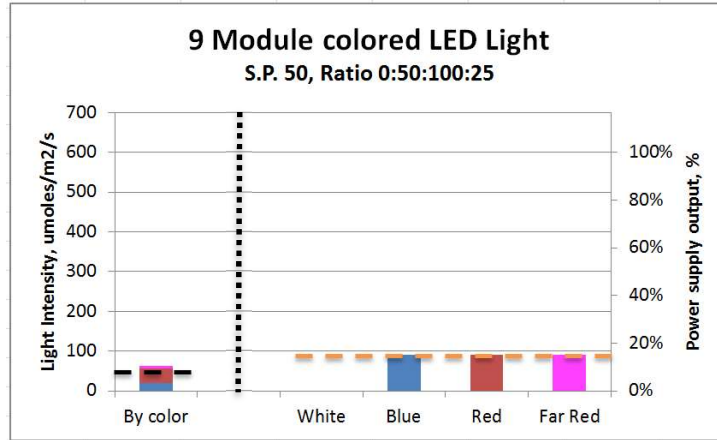

Example 7

Door Light Interior Viewing White Light (only with LGHT331 thru LGHT339)

Raising plants can be difficult to see whether plants are growing properly without the full color spectrum. This feature allows the customer to temporarily see inside the chamber with full spectrum lighting (regardless of setting: white lights on, colored lights off). There is a manual mode controlled by the HMI (when the customer uses the viewing window) and automatic mode (when customer uses the full door and light change is activated by a door switch).



If the Auto button is enabled . When the door is opened the colored lights will turn off, and the white lights will remain on.

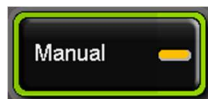

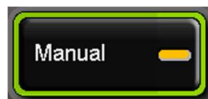
If the Manual button is enabled . The colored lights have to be turned off manually by the user. This feature will deactivate after 1 minute.

This feature is located under the Setup Menu part of the touchscreen.

Operation of Ramp/Soak Control (RAMP301)

A ramp and soak control system allows the user to store up to 50 steps spanning 5 profiles. A step consists of a change in setpoint (ramp), or maintain a setpoint for a fixed duration (soak). A step(s) can be repeated any number of times from 1 to 0 255 or infinite (repeat).

There are up to 4 different parameters that can be set up for the Ramp/Soak control: Temperature, Humidity, CO₂ and Lights (select models & accessories).

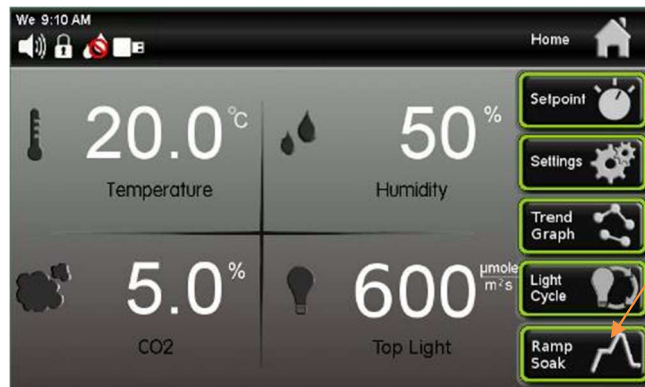

Ramp Soak button



Press the  (Ramp Soak) button on the Home screen.

Profile button



Start / Stop Ramp profile button



Press the  (Profile) button.

Profile Step buttons



Current Profile

Continue to Profile button

Press the  (Step 1) button.

Ramp button

Unused button



Repeat button

Current Step

Soak button

Press the  (Ramp) button.

Ramp Rate parameters

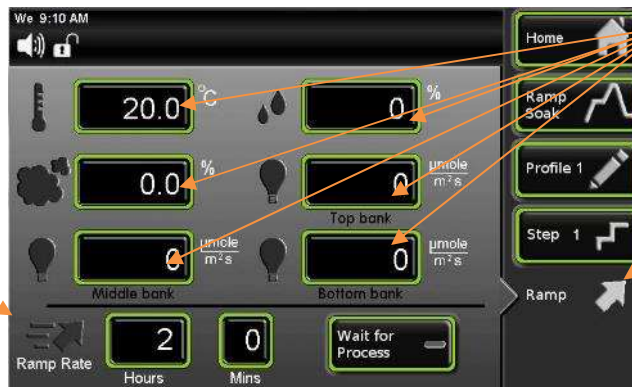

Parameters that can change for profile

Step type

To set the ramp temperature value, press the  (Temperature) button.

Enter the value of 30 and press  (Enter).



Ramp rate allows a user to control the rate which parameters (temperature, humidity, CO₂, lights) change when transitioning to a new setpoint. This allows for a more gradual change than otherwise would occur.

Temperature tolerance range is 1°C when ramping temperature.

Humidity tolerance is 2% when ramping humidity.

There are (4) conditions to ramp to a new setpoint:

- 1) Ramp Rate = “0”, and “Wait for Process” button is not checked.
The chamber will work to reach the new setpoints as quickly as it can. The program will proceed to the next step immediately (before setpoints are reach).
- 2) Ramp Rate = “0” and “Wait for Process” button is checked.
The chamber will work to reach the new setpoints as quickly as it can. The program will wait until the chamber reaches the setpoint (tolerance) before proceeding to the next step.
- 3) Ramp Rate is a specified time, and “Wait for Process” button is not checked.
The chamber will work to maintain the ramp rate specified. The program will proceed to the next step when the time duration is complete, regardless if the setpoints have been reached or not.
- 4) Ramp Rate is a specified time, and “Wait for Process” button is checked.
The chamber will work to maintain the ramp rate specified. The program will proceed to the next step when the time duration is complete AND the chamber setpoints have been reached.

Using the time feature, the ramp cycle will run for the specified length of time then go the next profile. To set the ramp rate time, press the  (Hours), and or  (Mins) buttons.

Enter desired ramp time. (2 hours for example)



Wait for Process

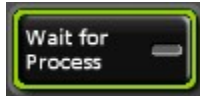

When  (Wait for Process) button is selected, the parameter step will wait until the setpoints have been reached before proceeding to the next step.

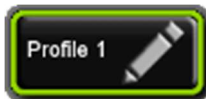

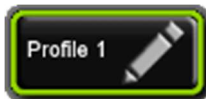
Press the  (Profile 1) button to go back to the Profile 1 screen to set up Step 2.

Step type icon



Step type icon indicates what function will occur at that step.





Press  (Step 2) button.



Press the  (Soak) button.



Press  (Hours) and or  (Mins) button(s) for desired soak time. This feature allows the unit to stay at the Ramp value for a specified amount of time before going to the next Step.

Enter values, example 2 hrs-10 mins.

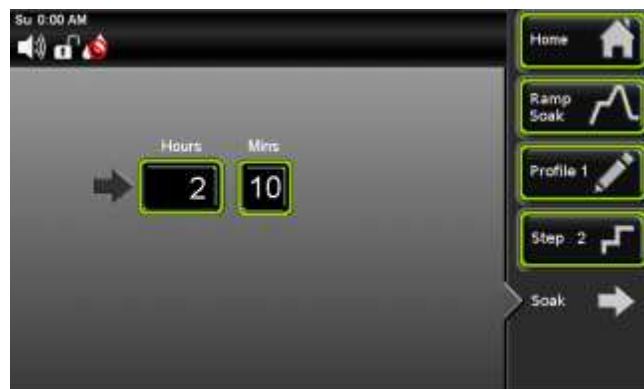

When finished entering values, press the  (Profile 1) button to go back to the Profile 1 screen to set up Step 3.



Press  (Step 3) button,



Choose the  (Repeat) button. To enter which step is to be repeated press the



and enter value on pop up key pad. There is a note that gives specific instructions which steps can be repeated. After entering the specified step, the number of repeats for that step can be specified. The # of repeats is a similar to a 'loop' that will allow a specified step to run continuously until the repeat cycle is complete, then it will move to the next step. The maximum number of repeats is 255.

What **cannot** be done is to create a repeat within a repeat or "nested" repeat. It is ok to have a repeat from step 7 to step 1 (black arrow), but not repeat step 9 to step 1 and include step 7 to step 1 (red arrow).

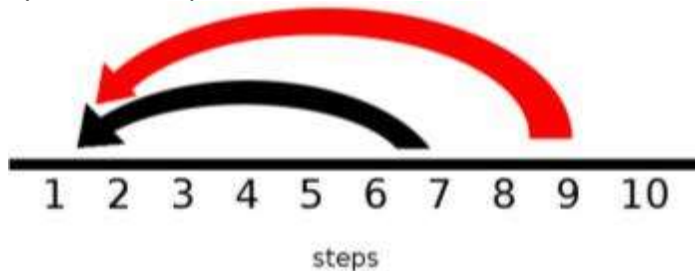



Enter values, example 2 for Step and 10 for # Repeats.

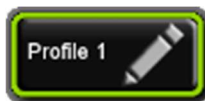

Once this is complete press the (Profile 1) button to return to the Profile 1 screen.



Press (Step 4) button.

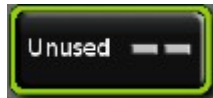

Choose the Unused button. The Unused step is set up to be the “default” condition.

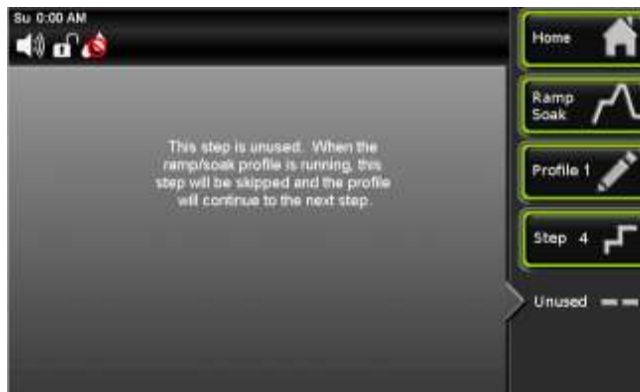

So when the Ramp, Soak or Repeat condition is not chosen for a step, the ramp profile program will skip over those unused steps.

When all of the Ramp profiles are entered, press the Start / Stop button and the ramp cycle program will run. The program can be turned off at any time during the process, but the Profile will start over from the beginning.

The other start / stop buttons for the other profiles will be greyed out indicating that only profile 1 has steps that can be run.

Ramp profile running



The Ramp icon will appear in the status bar .

Pressing this icon a pop up screen will appear with the profile steps that were chosen and what the current step the program is on. This is indicated by the orange bar.

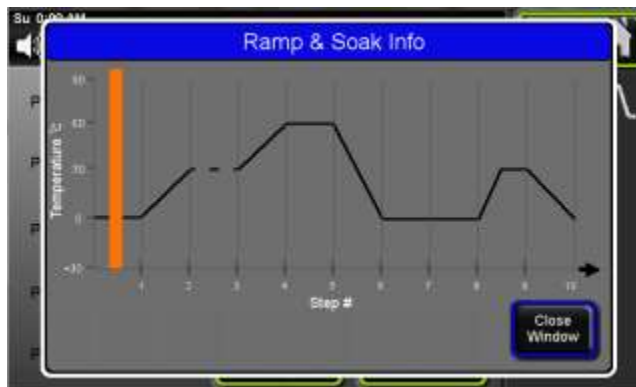

When a ramp cycle has more than 10 steps, there is a button that will allow the steps to continue to the next profile. With the Profile screen open, at the bottom of the screen



Continue to Profile button

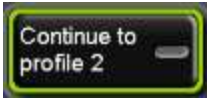

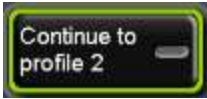
press the  (Continue to profile) button. This will allow you to go to the next profile and set up the next number of steps. The numeric value shown will change based on the next available profile.



When finished creating of the required steps, press the  (Ramp Soak) button to go back to Ramp Soak Profile screen.

Continue to next Profile icon



The black arrow indicates that after first profile 1 (1-10) is finished it will continue on to profile 2 (11-20).

This example screen is showing all 5 profiles are being utilized, up to 50 steps.



Operation of Front Mounted 6" Recorders (RCDR316, RCDR317)

Built in 6" ink pen temperature and or humidity recorders can be purchased with Caron chambers. The recorders are shipped installed on the outer door of the chamber from the factory and require no installation.



Changing the chart paper:



Press and hold the “change chart” button on the recorder (#3) for approximately one second until the pen begins to move to the left of the chart and then release the button. Wait until the pen has completely moved off of the chart. To remove the chart paper, unscrew (counter-clockwise) the chart “hub” knob at the center of the chart. Remove the old chart paper and position the new one so that the correct line coincides with the time line groove on the chart plate.

Re-attach the chart “hub” knob and fasten securely against the chart. Press and hold the “change chart” button (#3) again for approximately one second until the pen begins to move back onto the chart and then release the button. Check to make sure that the pen is marking on the chart paper. If it is not, then carefully adjust the pen arm to establish contact with the paper.

Chart recorder marking system:

This type of pen consists of a self-contained ink reservoir with a porous plastic stylus which is snapped around the outer edge of the metal pen arm. A pen cap is provided to extend the life of the ink pen during shipping or when the recording unit is not in service. To remove the pen cap, gently lift the pen arm away from the chart paper. Remove the black plastic pen cap to expose the fiber tip of the ink pen and gently place the pen back onto the chart paper. Do not let the pen arm "snap" back onto the chart paper. This will flatten the fiber tip of the pen and will no longer give you a fine line marking on the chart paper. Place the pen cap in a safe place for future use. If the stylus does not touch the chart, adjustment can be made by slightly bending the metal pen arm in the center towards the chart paper. Do not use more pressure than is necessary to create a fine line marking on the chart paper. As the pen ink supply runs out, the pen color will become lighter. This indicates that the pen should be replaced.

Replacement of the Pen:

Recorders that are equipped with fiber tipped cartridge pens will have a cartridge that is color coded "red" to designate pen number one and an optional cartridge that is color coded "blue" to designate pen number two. The pen cartridge is securely fastened to the metal pen arm using a special "U" clip tab. For ease of replacement, it is suggested that the two screws that hold the pen arm be loosened and the pen cartridge and metal pen arm be removed as an assembly. Unsnap the plastic "U" clip tab of the pen cartridge from the metal pen arm, remove and discard the old pen cartridge. Replace the new cartridge by opening the hinge and snapping it securely around the metal pen arm. Refer to the image below:

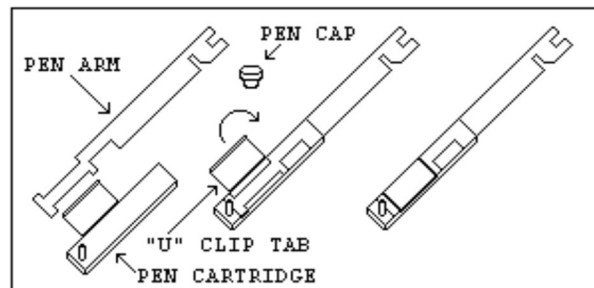

Pen Arm Calibration:

To check and/or adjust the recording pen(s) calibration to the outer most temperature graduation of the chart, press and hold the "change chart" button (#3) until the pen begins to move off of the chart. Once the pen(s) has moved off of the chart, again press and hold the "change chart" button (#3) until the pen begins to move back onto the chart. The pen should briefly stop at the outer most temperature graduation of the chart before continuing onto the chart to begin recording. If the pen does not stop exactly at this location on the chart, it can be adjusted or "calibrated" by using the left (#1) or right (#2) arrow buttons.

When the pen moves back onto the chart and briefly stops, you will have approximately five seconds in which to adjust the pen's position using the left and right arrow buttons of Figure 3.

On multiple pen recorders, each pen will move (one at-a-time) onto the chart briefly stopping at the outer most temperature graduation of the chart at which time the pen's position can be adjusted by using the left (#1) or right (#2) arrow buttons. When the time to adjust the position of the first pen has expired, the second pen will move onto the chart briefly stopping at the outer most temperature graduation of the chart at which time the second pen's position may be adjusted.

Each time the chart paper or fiber tip pen cartridge is changed, you should make sure that each pen stops at the outer most temperature graduation of the chart paper. Otherwise, this pen offset will cause the unit to record an incorrect temperature on the chart.

Recorder Calibration:

If a calibration adjustment is required for a single pen recorder, use the left (#1) and right (#2) arrow push buttons on the recorder to calibrate (or move) the pen's position on the chart to correspond to the temperature of the solution. The arrow buttons must be held for approximately five seconds before the pen will begin to move.

For two pen recorders, you must first select the pen that you wish to calibrate. This is done by pressing the left (#1) arrow button to select the red pen or the right (#2) arrow button to select the blue pen. The arrow button must be held down until the green LED light goes out. After the green LED light goes out, follow the instructions in step #3 above.

Battery Backup:

The green LED light remains a constant green color indicating that both the battery and the main power to the unit are good. Refer to Figure 5 for the location of the green LED indicating light. If the AC power were to fail or the battery becomes weak, then the green LED light will begin "flashing" indicating that either you have lost the main power to the unit or it is time to replace the battery. Having a 9 volt DC battery back-up in place, will allow the recorder to continue to function normally for approximately 24 hours in the event of a power failure.

Operation of Front Mounted 10" Recorders (RCDR318, RCDR319)

Built in 10" thermal pen recorders can be purchased with Caron chambers. The recorders are shipped installed on the outer door of the chamber from the factory and require no further installation. Unlike ink pen recorders, the thermal recorders draw their own chart and control lines.

The 10" recorders have been setup at the factory in the following configuration: 7 Day / 24 Hour / Temperature 0-100°C / Humidity 0-100% (for dual input recorders). If this is not the ideal configuration for an application, the recorder may be reconfigured using the following process:

Configuring the recorder:

In order to configure the recorder, you will need to enter the set-up mode of the recorder. To enter the set-up mode of the recorder, press and hold the Change Chart button (#3) until the thermal pen arm begins to move off scale and then release the button.

Note: The green LED light will flash fast while the thermal pen arm is moving off scale.

Wait until the thermal pen arm has moved completely off scale and stops (the green LED light will stop flashing and will be steady On). Unscrew (counter clockwise) the chart "hub" knob at the center of the chart and remove the recording chart paper. Gently lift the thermal pen arm just enough to be able to slide the paper out from beneath it. Remove the recording chart paper and place the Setup Chart onto the recorder. This chart contains the configuration categories of the recorder (Probe Input, Inner Chart Temperature, Outer Chart Temperature, Temperature Scale, Chart Rotation Speed, Input Filtering, Optional Relay Contacts and Date/Time for internal clock).

Next, press and hold either button #1 or #2 until the green LED light goes out and release the button. If this step is successfully completed, the pen arm will move to the outermost graduation ring of the Setup Chart. Use the Left (#1) or Right (#2) arrow buttons to adjust the center of the thermal pen to be on this outermost graduation ring.

Position the Setup Chart so that the tip of the thermal pen is in the center of the Start circle. Tighten the chart hub knob to secure the chart in place. Next, press and release the Change Chart button to begin. The chart will rotate to the first category (Input #1). Use the Left and Right arrow buttons to move the thermal pen arm to the desired option of each category. Press and release the Change Chart button to accept the selection and advance to the next category. You must press and release the

Change Chart button when you have finished configuring the last category in order to save all of the changes that have been made to the recorder's configuration.

The thermal pen arm will move off of the chart allowing you to place the recording chart paper onto the recorder. Press and release the Change Chart button to begin recording.

Changing the Chart Paper:

Press and hold the Change Chart button (#3) for approximately one (1) second until the pen begins to move off scale and then release the button.

Note: The green LED light will flash fast while the thermal pen arm is moving off scale.

Wait until the thermal pen arm has moved completely off scale and stops (the green LED light will stop flashing and will be steady On). To remove the chart paper, unscrew (counter clockwise) the chart "hub" knob at the center of the chart. Gently lift the thermal pen arm just enough to be able to slide the paper out from beneath it. Remove the old recording chart paper and position a new one.

Re-attach the chart "hub" knob and screw securely (by hand) against the chart. Press and hold the Change Chart button (#3) again for approximately one (1) second and the thermal pen arm will move back onto the chart and begin recording.

Green Light LED Status:

The green LED light (located just below the three button membrane switch) is used to show the recorder's status:

1.) LED on steady (not flashing) and input(s) recording within chart range, indicates unit is recording normally.

2.) LED on steady (not flashing) and pen arm above outermost graduation and not moving, indicates recorder is in Change Chart mode. Press and release Change Chart button to return to normal recording mode.

3.) LED flashing rapidly and one or both inputs recording at outermost or innermost graduation indicates a sensor break. Check or replace sensor(s). If sensor(s) are ok, make sure process temperature is within configured range of recorder.

4.) LED flashing slowly (.8 seconds ON / .8 seconds OFF) indicates recorder is in Set-Up mode. Refer to section CONFIGURING THE RECORDER.

5.) LED is Off indicates that there is no power to the recorder. Check A/C power to the recorder.

Recorder Calibration:

If calibration is required for single input recorders, use the Left (#1) and Right (#2) arrow buttons on the recorder to calibrate the temperature being recorded on the chart to correspond to the temperature of the solution. The arrow buttons must be held for approximately eight (8) seconds before the pen begins to move.

If calibration is required for dual input recorders, you must first select the input that you wish to calibrate. This is done by pressing and holding the Left (#1) arrow button to select Input #1 or the Right (#2) arrow button to select Input #2. The arrow button must be held down until the green LED light turns off, after which follow the instructions in single input instructions above.

Maximizing Pen Life:

In order to maximize the amount of life expected out of the thermal pen tip, follow these simple rules:

- 1) Never let the thermal pen tip ride on the chart plate when the chart paper is not present. This will damage the protective coating of the heating element.
- 2) Never use chart paper that is creased or that has been folded.
- 3) Periodically clean the thermal pen tip with a cotton swab dipped in alcohol. Clean more often when operating the recorder in a dusty environment.
- 4) Always keep the door closed while the unit is recording.
- 5) Never lift the pen arm more than is necessary to remove and replace the chart paper. Excessive lifting may cause a decrease in the pen tip pressure and cause light printing.

CALIBRATION

The temperature and humidity systems can all be calibrated as necessary. Caron recommends an annual calibration check of each system. Before making a calibration adjustment, allow the cabinet to stabilize a minimum of 12 hours from a power off condition. If the unit has been in operation, allow a minimum of 3 hours of stable operation at all setpoints.

If you do not have the appropriate reference instruments to perform calibration, contact Caron's service department for on-site calibration at www.caronproducts.com Caron also provides validation services which ensure that the unit is functioning properly according to IQ, OQ and PQ protocols which satisfy FDA guidelines for qualification verification of equipment.



Be sure that all reference instruments are calibrated to an appropriate standard.

The Calibration Screen

To get to the calibration screen from the home page:

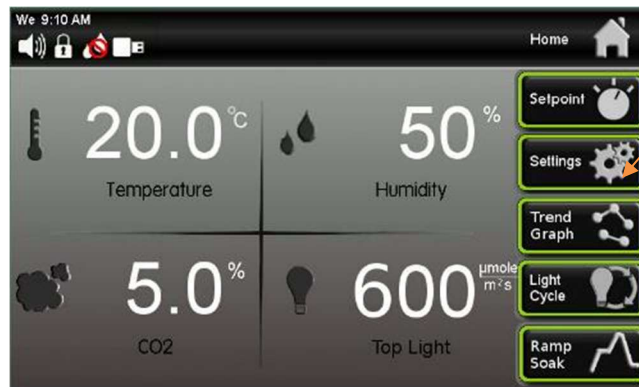

Settings Button



Press the  (Settings) button.

Calibrate Button

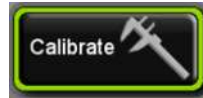

Once the settings screen appears, press the  (Calibrate) button.

Temperature Calibrate Button

CO₂ Calibrate Button

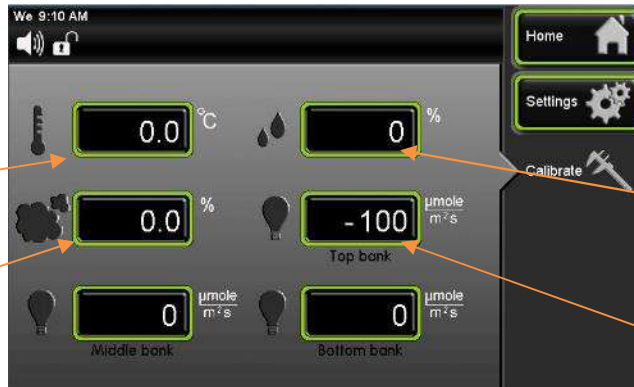

Humidity Calibrate Button

Lights Calibrate Button

If optional features such as CO₂ are purchased, a calibration button will also appear for those options.

Calibrating Temperature

If temperature calibration is needed, perform either Method A or Method B.

Method A (geometric center)

Locate the reference instrument's temperature sensor in close proximity to the cabinet's geometric center. Turn the lights 'off'. Let the unit stabilize for at least 3 hours at the temperature setpoint.

Method B (chamber sensor)

Locate the reference instrument's temperature sensor behind the rear wall duct sheet and adjacent the chamber's existing temperature sensor (within 1 inch (25 mm)). See temperature sensor location in the Equipment Overview section of this manual. Be sure to re-install the rear wall access door panel that covers the sensors. For this method, the lights may be 'on' or 'off'. Let the unit stabilize for at least 3 hours (lights 'off') or 6 hours (lights 'on') at the temperature setpoint.



In both temperature calibration methods, the temperature sensor *must be* out of incident light during the calibration process.

Temperature Calibrate Button



At the calibrate screen, press the  (Temperature Calibrate) button.



Keypad



Enter the temperature offset by using the keypad and pressing  (Enter) when complete.

A positive value will move the temperature 'up' and a negative value 'down'. Press the 'home' button and verify the proper temperature is displayed.

Temperature calibration (example)

If the chamber temperature display reads 40.0°C and the calibrated independent sensor shows 40.3°C, set the temperature offset value to 0.3°C. If the calibrated independent sensor shows 39.6°C, then the entered offset should be negative. In this example the required offset to temperature would be -0.4°C.

Calibrating Humidity

If humidity calibration is needed, the same Method (A or B) should be following as in the temperature calibration. Humidity calibration must be performed concurrently with temperature calibration.



Be sure the same Method is used for humidity calibration as temperature calibration and must be performed concurrently.

Method A (geometric center)

Locate the reference instrument's humidity sensor in close proximity to the cabinet's geometric center. Turn the lights 'off'. Let the unit stabilize for at least 3 hours at the temperature *and* humidity setpoint.

Method B (chamber sensor)

Locate the reference instrument's humidity sensor behind the rear wall duct sheet and adjacent the chamber's existing humidity sensor (within 1 inch (25 mm)). See humidity sensor location in the Equipment Overview section of this manual. Be sure to re-install the rear wall access door panel that covers the sensors. For this method, the lights may be 'on' or 'off'. Let the unit stabilize for at least 3 hours (lights 'off') or 6 hours (lights 'on') at the temperature *and* humidity setpoint.



In both humidity calibration methods, the humidity sensor *must be* out of incident light during the calibration process.

A positive value will move the humidity 'up' and a negative value 'down'. Press the 'home' button and verify the proper humidity is displayed.

Humidity calibration (example)

If the chamber humidity display reads 80% and the calibrated independent sensor shows 83%, set the humidity offset value to 3.0%. If the calibrated independent sensor shows 74%, then the entered offset should be negative. In this example the required offset to humidity would be -6.0%.

Calibrating CO₂

If CO₂ calibration is needed, the same Method (A or B) should be following as in the temperature (& humidity) calibration. CO₂ calibration must be performed concurrently with temperature (& humidity) calibration.



In both CO₂ calibration methods, the CO₂ sensor *must be* out of incident light during the calibration process.

A positive value will move the CO₂ 'up' and a negative value 'down'. Press the 'home' button and verify the proper CO₂ is displayed. (See Temperature Calibration Example.)

Calibrating Lights

If light calibration is needed, perform either Method C or Method D.

The chamber uses a high-quality PAR calibrated light sensor for light detection.

Be sure the reference instrument's light sensor is a traceable PAR (Photosynthetically Active Radiation) sensor in units of $\mu\text{mole}/\text{m}^2/\text{s}$.



For models with colored lights, the recommended calibration method is to calibrate the sensor under the colored light ratios and intensity as intended

When calibrating the sensor under colored lights, do not calibrate to far-red light only.

Method C (geometric center)

Place the chamber's light sensor (which is attached to the light sensor bracket) on the rear duct sheet approximately 6 inches from the lamps and centered left-to-right. Locate the reference instrument's light sensor in the shelf center and at a distance of 8 inches from the lamps. Turn the lights 'on' and let the unit stabilize for at least 15 minutes at 20C. Adjust the light calibration so the chamber light intensity reading matches the reference light sensor.



Method D (chamber sensor)

Place the chamber's light sensor (which is attached to the light sensor bracket) on the rear duct sheet approximately 4 inches from the lamps and centered left-to-right. Locate the reference instrument's light sensor adjacent the chamber's light sensor. Turn the lights 'on' and let the unit stabilize for at least 15 minutes at 20C. Adjust the light calibration so the chamber light intensity reading matches the reference light sensor.



Light sensor calibration *must be* performed with the lights 'on' and in direct lighting. Caron recommends calibrating the lights *after* the temperature & humidity (if applicable) are calibrated.

Note: the chamber's light intensity specification is with a distance of 6 inches (15 cm) beneath the lamps in the center of the shelf. It is expectant that lower light readings will be obtained further away from the lights and at the edge of the shelf.

A positive value will move the light intensity 'up' and a negative value 'down'. Press the 'home' button and verify the proper light intensity is displayed. (See Temperature Calibration Example.)

Calibrating Optional Chart Recorders

For calibrating the optional front and side mounted chart recorders, refer to section (Optional Accessory Operation)

ALARMS

Alarm System Overview

The chamber light intensity and control system is equipped with an alarm system that constantly monitors temperature, and humidity (on humidified models) to ensure the user is notified if the cabinet goes into an alarm condition. Notification occurs via an alarm pop-up window and a buzzer. Each alarm condition has been factory programmed to minimize nuisance alarms while maximizing warning time. There is a 2-hour time delay after start-up and setpoint changes. To avoid nuisance alarms after a routine door opening, an alarm condition must be present for 15 minutes* (45 minutes for humidity) before the operator is alerted. If the optional remote alarm contacts are present, in an alarm condition, the dry contacts will change state.

*Alarm delays are adjustable, see “Changing Alarm Setpoints and Delay” for details.

The following alarm messages may be displayed:

- Chamber temperature is higher than setpoint temperature
- Chamber temperature is lower than setpoint temperature
- Chamber humidity is higher than setpoint humidity
- Chamber humidity is lower than setpoint humidity
- Chamber CO₂ is higher than setpoint humidity
- Chamber CO₂ is lower than setpoint humidity
- Chamber light intensity is higher than setpoint intensity
- Chamber light intensity is lower than setpoint intensity
- Temperature sensor error

In the event an alarm occurs, the alarm indicator will appear on the status bar and an audible alarm pop-up window will automatically appear.



The flashing  (Alarm) icon will appear on the status bar.

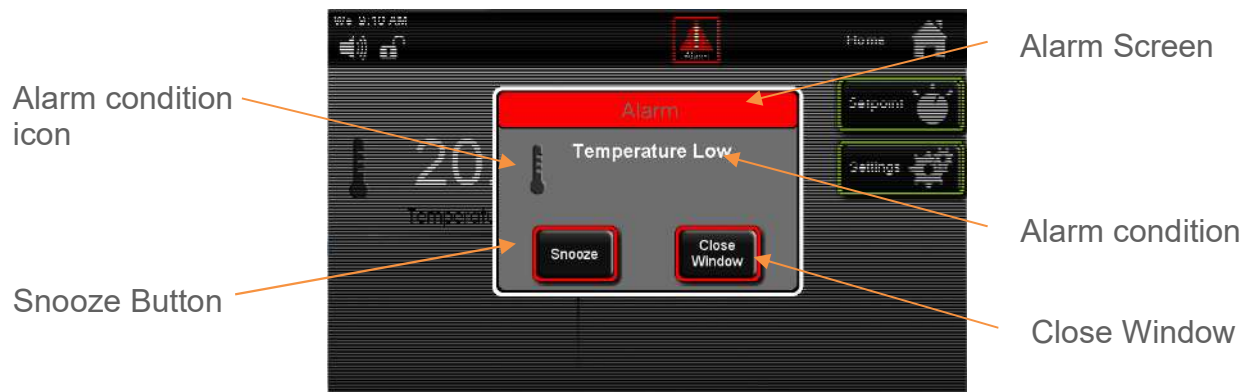

Audible Alarm Snooze Function:

When in an alarm condition, the Audible Alarm can be temporarily silenced to avoid being a nuisance to those nearby. The Audible Alarm will repeat after 1 hour has passed, if the condition has not been corrected. (The audible alarm will not sound if the alarm is muted, see Audible Alarm Mute)



Press the  (Snooze) button, the audible alarm is silenced for a period of 60 minutes.

When the alarm condition is corrected the alarm indicator and the audible alarm will automatically turn off (unless there is another alarm condition).

To check what the alarm condition is, press the  (Alarm) button on the status bar.

and the alarm window will be displayed. If the  (Snooze) button has already been pushed and 60 minutes have not passed the Snooze button will be “greyed” out.



If you press the  (Close Window) button, the Alarm Window will close, but the alarm will still be present as a flashing alarm icon on the status bar for the remainder of the 1 hour of time. It will not reset the 1 hour alarm countdown time if the alarm condition is viewed on the pop up window.

After the 1 hour time has passed for an alarm condition, the counter will reset itself to 1 hour and repeat the countdown process again until the alarm has been resolved.

Audible Alarm Mute:

By factory default, when an alarm condition is present, the speaker will sound. This speaker can be muted in an 'on/off' fashion eliminating all audible sounds. (Muting the speaker will silence it until manually 'un-muted'. This is different than 'snooze' in the fact that snooze can only be enabled when an alarm condition is present and only lasts for 1 hour.) When the speaker is muted, the alarm icon continues to flash and the remote alarm contacts (optional) remain in the 'alarm' state.

To mute the audible alarm:



Press the  (Settings) button.

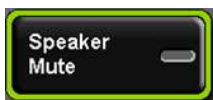



Press the  (Speaker Mute) button.



Speaker Mute icon

Speaker Mute button "On", indicator



The Speaker Mute button toggles to the "on" position , and the speaker icon changes to  "Speaker Muted" icon.

Changing Alarm Setpoints and Delay

All alarm setpoints were pre-set at the factory to minimize nuisance alarms that could be created as a result of door openings. Alarm setpoints can be changed based on individual user requirements. Alarm values are deviations from the setpoint and are not actual setpoint values.

To change the alarm setpoints and delay:

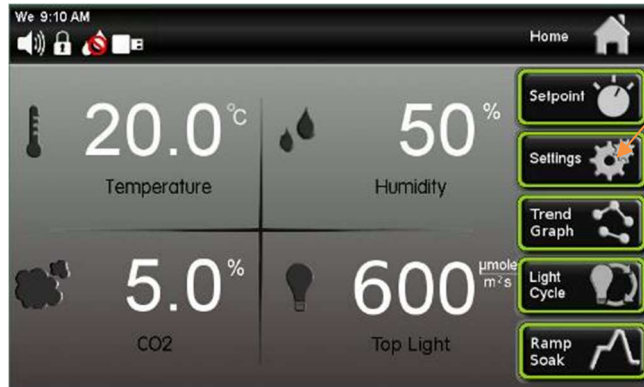

Settings Button

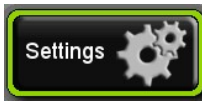

Press the (Settings) button.



Alarms Button

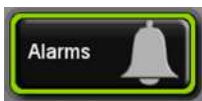

Press the (Alarms) button.



Temperature Alarm Button

Humidity Alarm Button

Lights Alarm Button

CO₂ Alarm Button

Press the  (Temp Alarm) button.

Temperature Alarm High Limit

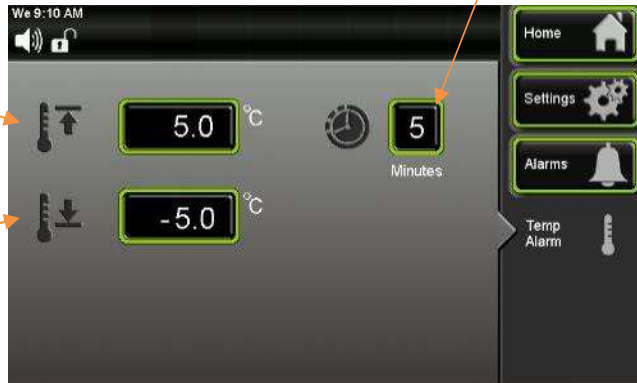

Temperature Alarm Low Limit





Once the alarm screen appears, press the  (Temp High Limit) button.

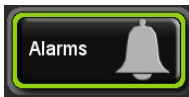

Keypad screen will appear. Enter the High Temp Alarm value; press  (Enter) when complete.

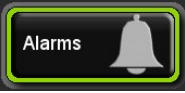
To change the Humidity Alarm, press the  (Alarms) button on the navigation menu to go back to the Alarms screen. Press the  (Humidity Alarm) button and repeat the same steps for humidity.

To change the Light Alarm, press the  (Alarms) button on the navigation menu to go back to the Alarms screen. Press the  (Light Alarm) button and repeat the same steps for lights.

To change the alarm delay, press the alarm delay button  and enter the delay in minutes.

ALERTS

Alert System Overview

The chamber control system is equipped with an Alert system that constantly monitors features of the chamber and notify the user if the cabinet needs any type of service to ensure good running performance of the chamber. Alerts draw user attention to regular maintenance needs, and minimize the risk of a future alarm condition.

When an Alert notification occurs, contact www.caronproducts.com with the serial number of the chamber to order preventative maintenance kit(s).

Some of the Alert features are: Check the Atomizers (humidified units only), Replace the Air Filter, and Check Equipment, Calibration is Due.

Notification occurs via an Alert icon on the status bar. When the Alert icon is pressed, a pop up window will display the alert condition(s). Each alert condition parameter is factory pre-set, no adjustment is necessary.

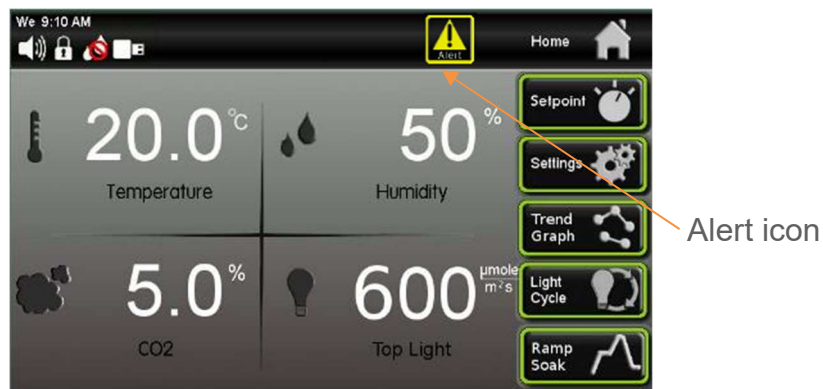

Press the  (Alert icon).



The Alert pop up window will appear displaying the alert message.



Press  (Close Window) button to make the pop up window disappear.

Resetting Maintenance Alerts

Maintenance Menu Screen lets users check to see how much time is remaining on an item that may need routine service or calibration. This is very convenient to inform the user that a particular item will need to have service performed soon. After service has been completed, the item needs to be reset causing the alert to disappear.

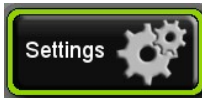
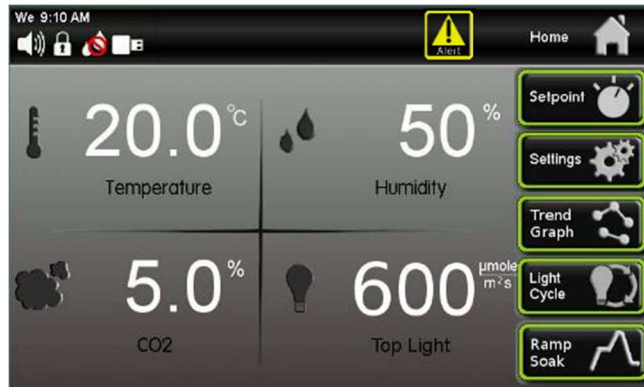

Press the  (Settings) button.



Once the Settings screen appears, press the  (Maintenance) button.



Once a Maintenance item is displayed on the Alert screen, it will continue to be present

as an icon in the Status Bar until the Maintenance item is corrected and the (Reset) button is pressed resetting the replacement time to “new” status.



Press the



(Home) button to return to the main screen.

INFO

Info System Overview

The chamber control system is equipped with an Information system that constantly monitors the chamber and to notify the user when an automatic condition is occurring. This applies to conditions such as Minimum Light Dimming Levels Reached or others that cannot be switched on and off by the user but is controlled automatically by the software of the control system. This notification cannot be disabled, it only lets the user know the chamber's current status.

Notification occurs via an Info pop-up icon on the status bar. When the Info icon is pressed a pop up window will display the Info condition(s).



The  (Info) icon will appear on the status bar.

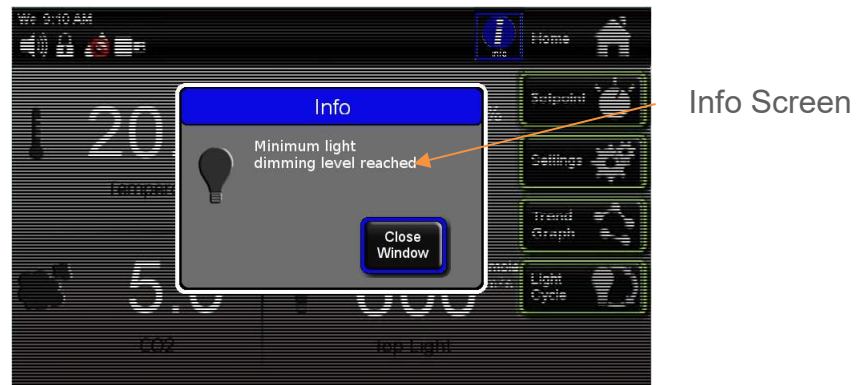

Press the  (Close Window) button to return to the main screen.

ADVANCED FEATURES

Setting the Time & Day

The chamber has an internal real-time clock that keeps track of the day and time. It is set at the factory to Eastern Standard Time and may need to be adjusted for your time zone. To keep the clock accurate, it will need to be adjusted manually for daylight savings time changes. To set the day & time:

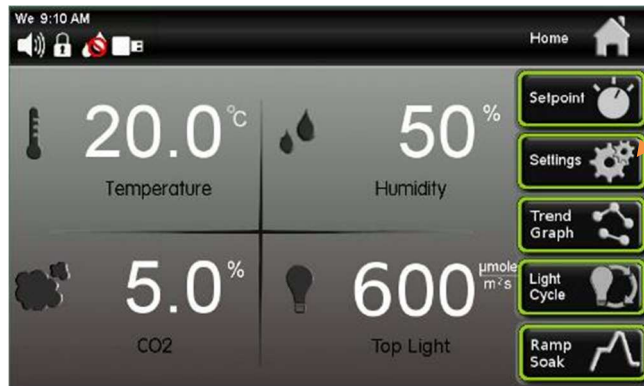

Settings Button

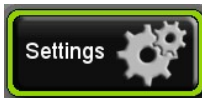

Press the  (Settings) button.



Setup Button



Press the  (Setup) button.



Day/Time Button



Press the (Day / Time) button.

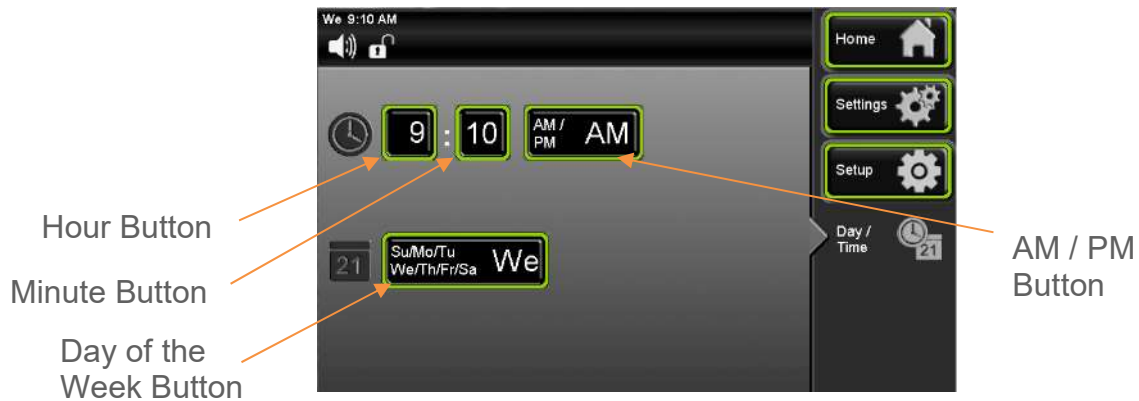

Hour Button

Minute Button

Day of the Week Button

AM / PM Button



Press the (Hour) button.



The Enter New Time in Hours window will appear. Enter the hour by using the keypad

and pressing  (Enter) when complete.

Follow same procedure for setting up minutes.

To setup AM/ PM, Press  (AM /PM) button and the words for AM and PM will toggle back and forth.

To set the Day of the Week, press the  (Day of the Week) button. This button will scroll through the days of the week, press until the abbreviated letters correspond to the actual day of the week.

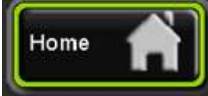
Press the  (Home) button to return to the main screen.

Locking the controls

To prevent unauthorized and accidental setpoint changes, the touchscreen can be locked-out. The passcode is required to lock-out the controls and the same passcode is used to unlock it. The factory default passcode is '1234'. This passcode can be changed by the user to create a unique 4-digit passcode. There is also a feature that will let you change the passcode from the factory default to a user defined passcode. The factory default for the screen lock is "unlocked"

To lock the touchscreen,



Press the  (Settings) button.



Press the  (Lockout) button.

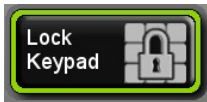
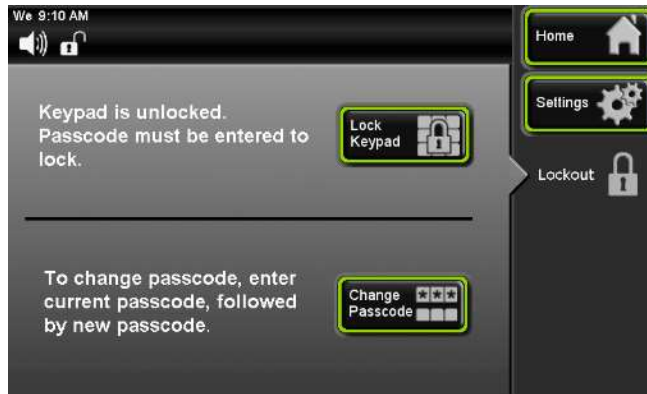

Press the  (Lock Keypad) button.



The Enter the Current Passcode Keypad screen will appear.



Enter digits “1 2 3 4”; press  (Enter) when complete.

The screen will change back to the Home Screen and the Control Lock icon will change to the “locked” position.

Control Lock Icon "locked"

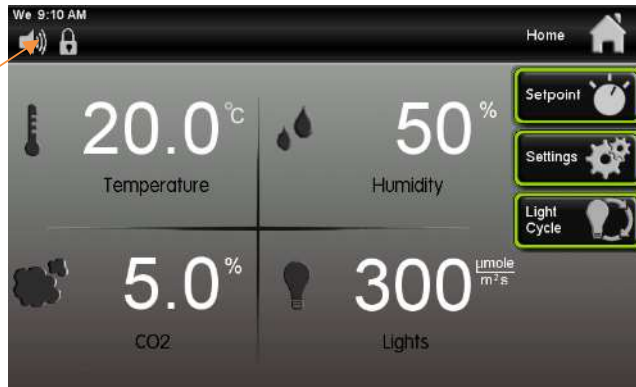

When any button is pressed on the home screen the following pop-up window will appear.



If the  button is pressed, the screen will change back to the Home Screen.



To unlock the touchscreen,



From the previous Alert "Keypad is Locked" pop up screen, press the  (Unlock) button. The Enter New Passcode window will pop up.



Enter the digits “1 2 3 4”; press  (Enter) when complete. The Control Lock Icon will change back to the “unlocked” position.

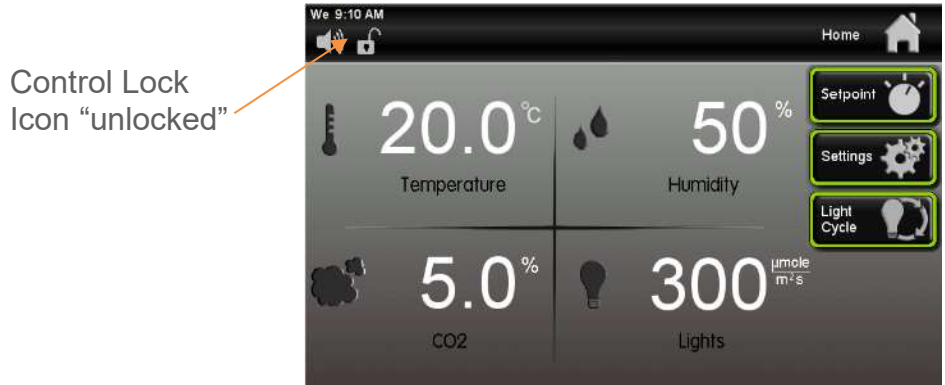

Changing the passcode

To prevent unauthorized and accidental changes being made to the chamber, the touchscreen can be locked-out. The passcode is required to lock-out the controls and the same passcode is used to unlock it. The factory default passcode is '1234'. This passcode can be changed by the user to create a unique 4-digit passcode. The current passcode is required to change the passcode.

To change the passcode,



Press the  (Settings) button.



Press the  (Password) button.

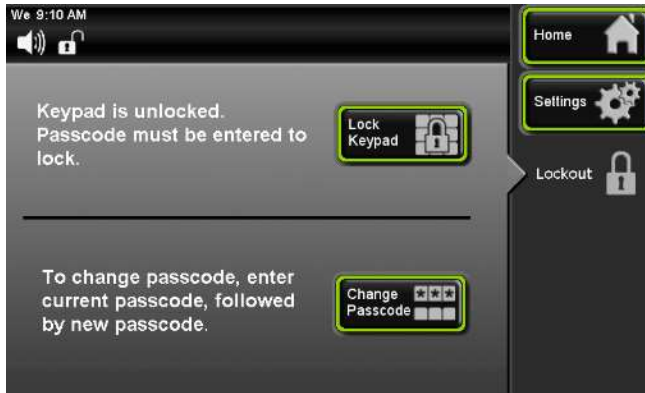

Press the  (Change Passcode) button.



The Enter Current Passcode Keypad screen will appear.



Enter digits "1 2 3 4"; press  (Enter) when complete.



The Enter New Passcode Keypad screen will appear.

Enter any new four-digit passcode (example: “2 5 8 0”). Then press  (Enter) when complete.



The Lockout screen will tell you that the Passcode has been changed to a new value. *This is only time that the Passcode will be displayed on the Lockout screen.*

Factory menu & troubleshooting

The chamber control system is equipped with advanced diagnostics features which allow the user to manually turn 'on' & 'off' each electronically controlled system. The factory menu can be used to

- View the current chamber configuration
- See the percent output of the control system
- Manually and individually toggle any output

To access the Factory Menu,



Settings
Button



Press the (Settings) button.



Factory
Button



Press the (Factory) button.



From the factory menu, four items can be selected. Press the **Model Details** (Model Details) button to view the chamber's configuration

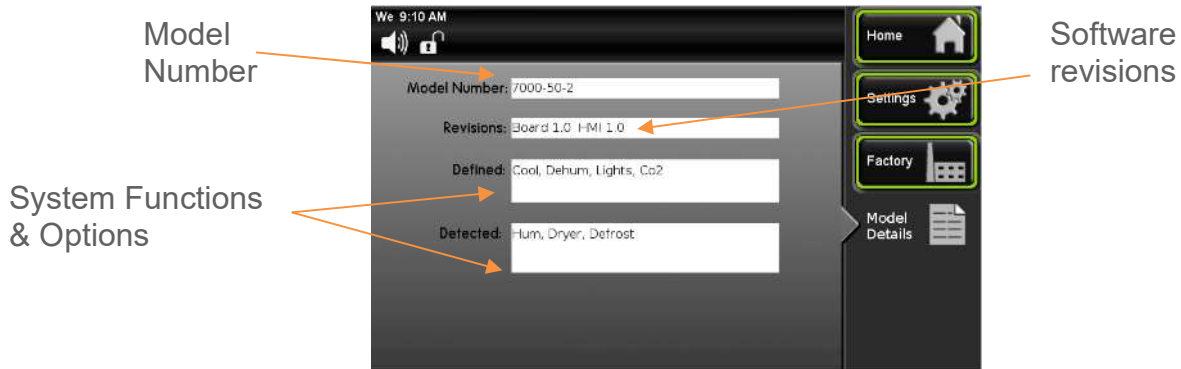

From the Factory screen, press the **Output Percent** (Output Percent) button to view the current percent output level of each control parameter.



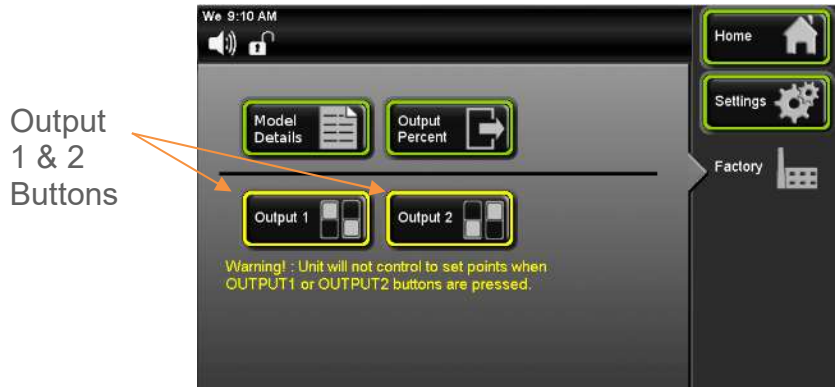

Navigating to the Output 1 or Output 2 screens in the factory page will temporarily halt chamber control & functionality.

To individually and manually control each output variable, from the factory screen press



the (Output 1) button. Note: Based on the chamber model number and options, not all functions will be present.



Each item can be turned on to check the condition of that device or parameter to aid in diagnosing a problem.



Press the (Output 2) button for other parameter buttons.



Chamber control & functionality is restored as soon as the screen is exited (Home, Settings, or Factory buttons). When finished with diagnosis in Output 1 or Output 2



screen, press the  (Factory) button to return to that screen. Once you go back to the Factory screen all parameters that were selected in Output 1 or Output 2 screens will reset to the “off” position.



Press the  (Home) button to return to the main screen.

PREVENTATIVE MAINTENANCE

The Caron chamber has been robustly designed to minimize performance problems. However, regular maintenance is very important for continuous trouble free operation.

As a general rule, Caron recommends an annual calibration check of the temperature and humidity systems. Caron offers a full range of on-site calibration and validation services. We also offer preventative maintenance contracts on our equipment. Contact our Service department for details at 740-373-6809 or visit us on the web at www.caronproducts.com.

Recommended Daily Maintenance Checks

- Check the Temperature and Humidity displays versus setpoints.
- Check for and correct any alarm condition.
- Check light modules for proper illumination.

Recommended Monthly Maintenance Checks

- Check to ensure the drain in the bottom of the unit is draining properly.
- Check front air intake filter. If the filter is dirty replace it with Caron Preventative Maintenance PM Kit. Washing the filter will result in poor performance.

Recommended Annual Maintenance Checks

- If humidity option, replace atomizer nozzle (see Replacement Parts section).
- Disinfect all interior surfaces with a general purpose laboratory cleaning agent.
- Perform a complete calibration of the temperature, lighting, and humidity systems.
- A full validation is recommended for GMP facilities each time a unit is installed, moved or undergoes significant repair. Contact Caron's service department to schedule on-site validation.

Here is a list of PM Kits that are available for models and accessories covered in this manual.

Model	PM Kit
7310-22	PM-7310-22
7310-50	PM-7310-50
7310-75	PM-7310-75
7311-22	PM-7311-22
7311-50	PM-7311-50
7311-75	PM-7311-75
7312-22	PM-7312-22
7312-50	PM-7312-50
7312-75	PM-7312-75
7314-22	PM-7314-22
7314-50	PM-7314-50
7314-75	PM-7314-75
7315-22	PM-7315-22
7317-22	PM-7317-22
7317-50	PM-7317-50
7317-75	PM-7317-75

Accessory	PM Kit
FLTR304	PM-FLTR304
FLTR307	PM-FLTR307
HUMD312	PM-HUMD312
HUMD313	PM-HUMD313
HUMD314	PM-HUMD314
RCDR316	PM-RCDR316
RCDR317	PM-RCDR317
RCDR318	PM-RCDR318
RCDR319	PM-RCDR319

SPECIFICATIONS

Item	Specification					
Temperature Range	15 to 45°C (lights 'on') 10 to 45°C (lights 'off')					
Humidity Range	Ambient to 85% (optional humidity)					
CO2 Range	0 to 20% (CO2C302 option)					
Door	Solid door, insulated, no glass					
Internal Volume	22 ft ³ (623 L); 50 ft ³ (1416 L) ; 75 ft ³ (2124 L)					
Shelf Dimensions	21.6" W x 26.5" H (549 mm W x 673 mm H)					
Shelf Area	4.0 ft ² (.37m ²) each					
Shelving	Overall: 28 shelf locations on 2" (50mm) centers, 54" (1372mm) from top to bottom shelf					
Interior Dimensions	22 ft³ : 22.5" W x 28" D (includes back duct) x 57.8" H (571mm x 711mm x 1468mm) 50ft³ : 51.0" W x 28" D (includes back duct) x 57.8" H (1295.4mm x 711mm x 1468mm) 75ft³ : 79.5" W x 28" D (includes back duct) x 57.8" H (2019.3mm x 711mm x 1468mm)					
Exterior Dimensions	30" W (includes side conduit channel) x 35.1" (plus 2/75" handle) D x 81.5" (including casters) H					
Interior Construction	Stainless Steel, 304					
Model	7310	7311	7312	7314	7317	7315
*Light Intensity (µmole/m ² /s)	600			300	1500	150
Number of tiers	1	2	3	4	1	6
Growth Height (in)	50.3	22.3/ 24.3	14.3	10.3/8.3	50.3	4.3
Intensity display	Standard					
Dimmable	Standard					
Dimmable by	shelf (22 ft ³); section (50 ft ³ & 75 ft ³)			N/A	shelf; section	N/A

*As measured 6 inches from light source

Model	7310			7311			7312			7314			7317			7315
Size	22	50	75	22	50	75	22	50	75	22	50	75	22	50	75	22
Number of tiers	1	1	1	1	1	1	3	3	3	4	4	4	1	1	1	6
Number of sections	1	2	3	1	2	3	1	2	3	1	2	3	1	2	3	1
Total # of shelves	1	2	3	1	2	3	3	6	9	4	8	12	1	2	3	6

Model	-1 (22 ft ³ only)	-2	-3
Electrical	115V, 60Hz (12A for -22)	230V, 60Hz (8A for -22) (12A for -50 & -75)	230V, 50Hz (8A for -22) (12A for -50 & -75)

Specifications are subject to change without notice.

Environmental Conditions: Temperature 15°C to 25°C, Humidity non-condensing

*See graph for details

**Includes export shipping crate

ELECTRICAL SCHEMATICS

7310 SERIES ELECTRICAL SCHEMATIC (PAGE 1 OF 10) REV A

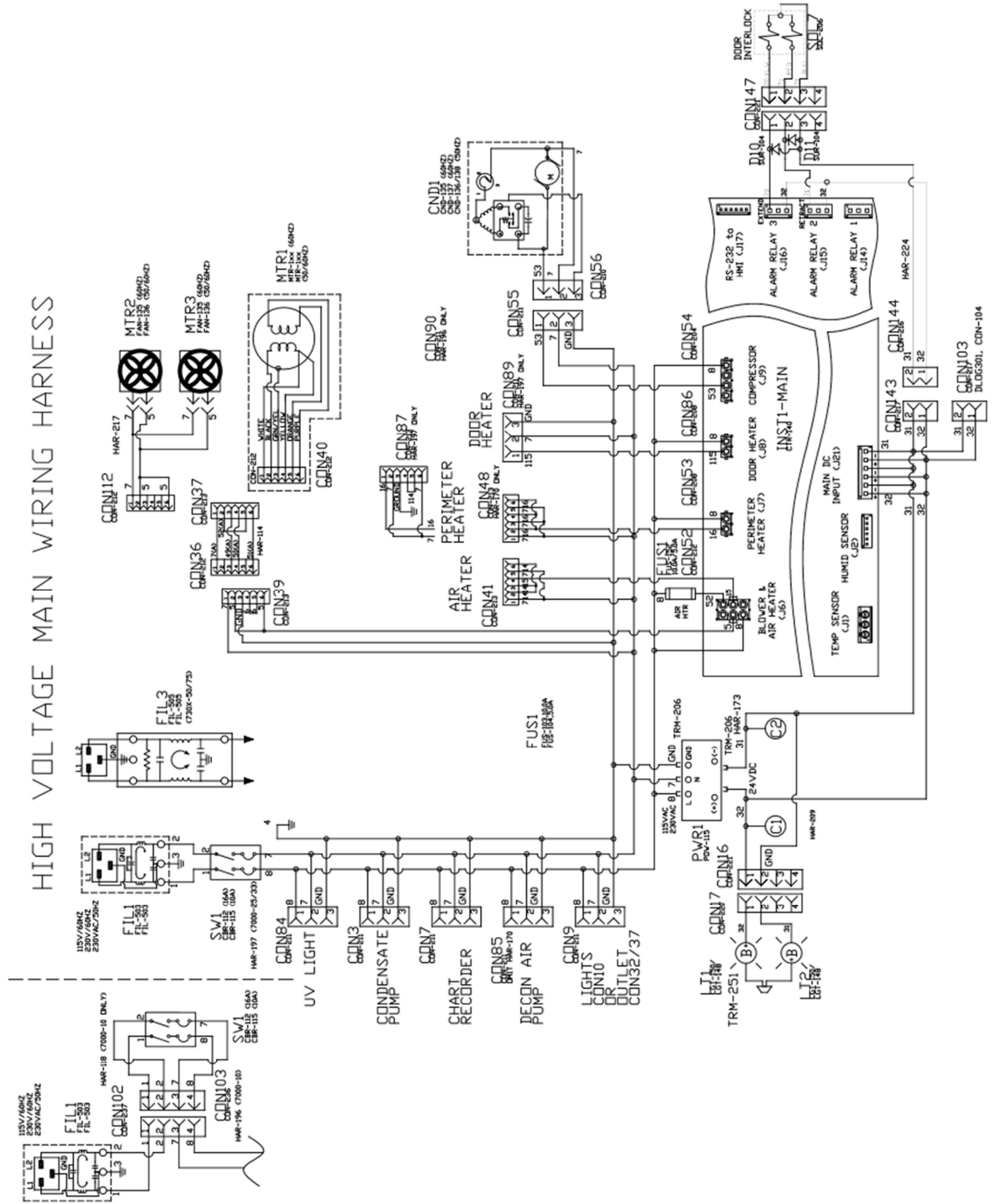

MAIN CONTROLLER BOARD (CTR-140)

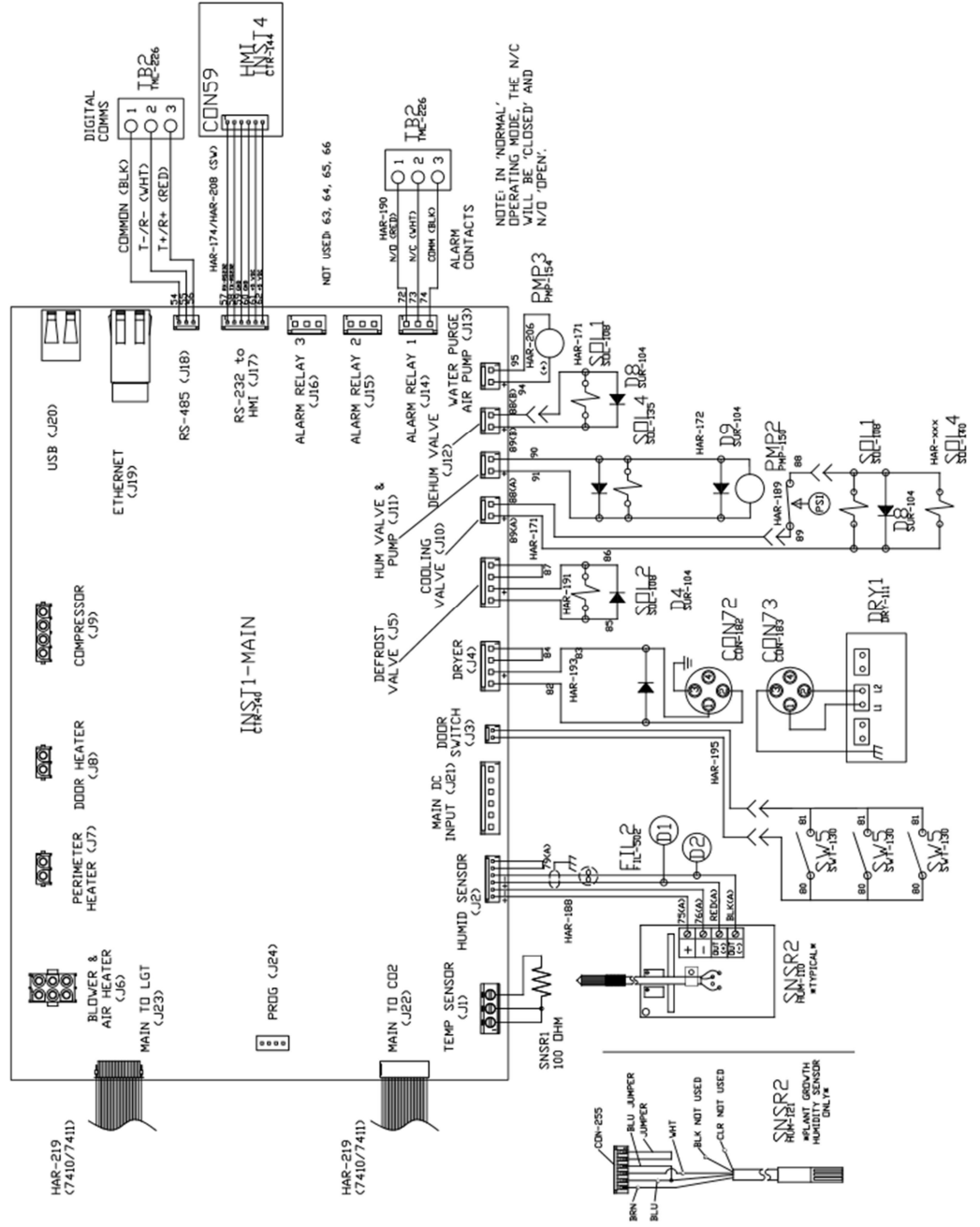

LED CONTROLLER BOARD (CTR-154)

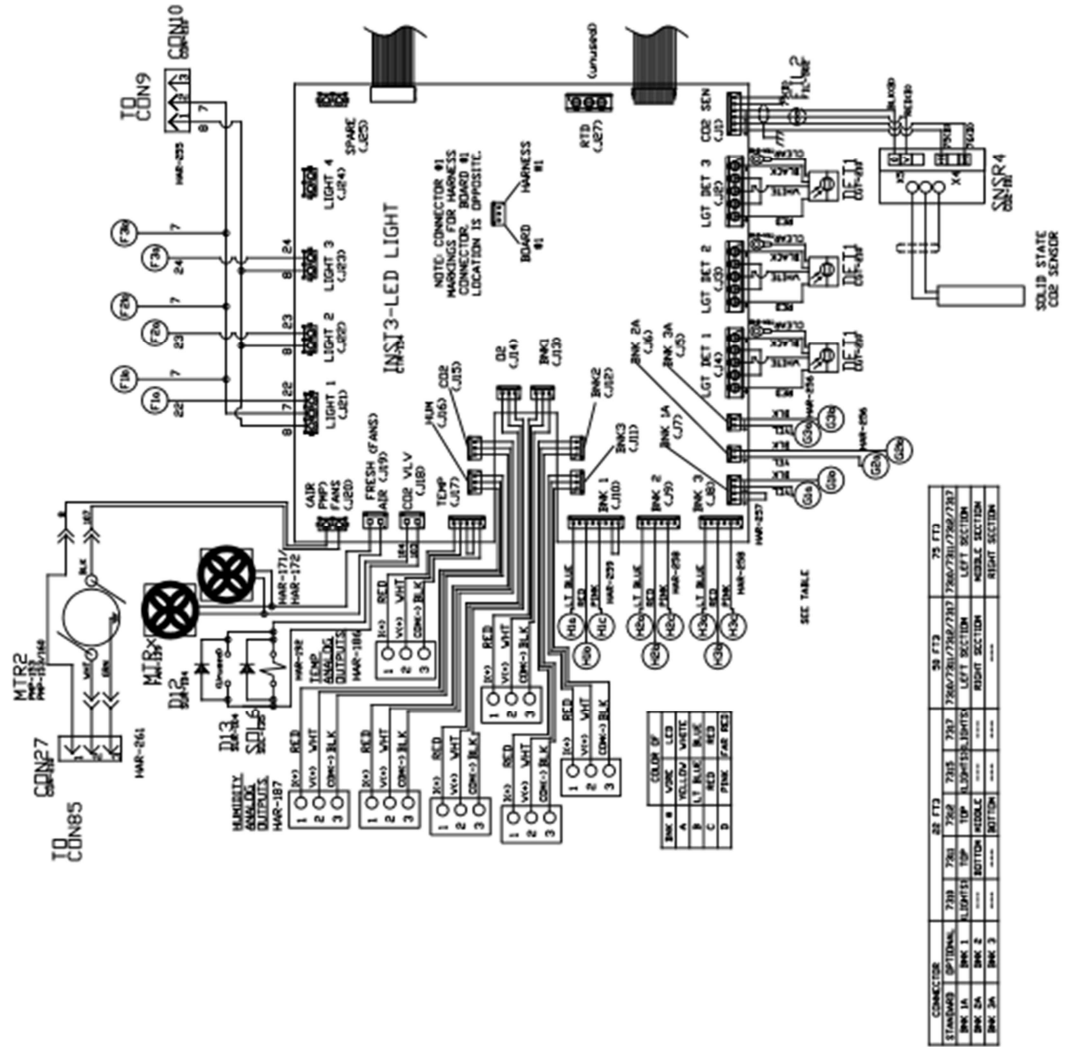

BANK #	COLOR OF WIRE
A	YELLOW/WHITE
B	LT. BLUE/BLACK
C	RED/BLACK
D	PINK/PURPLE/RED

CONNECTOR	22 FT3	25 FT3	28 FT3
STANDARD OPTIMUM	7310	7312	7313
BANK 1	TOP LEFT SECTION	TOP LEFT SECTION	TOP LEFT SECTION
BANK 2	MIDDLE SECTION	MIDDLE SECTION	MIDDLE SECTION
BANK 3	RIGHT SECTION	RIGHT SECTION	RIGHT SECTION

INDIVIDUAL POWER SUPPLY & CABLE (PER BANK)

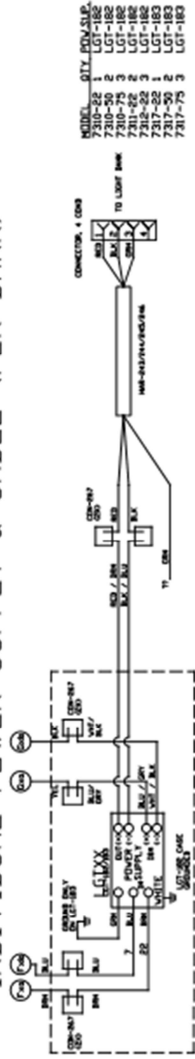

2 CONNECTED P.S. & CABLE (BANKS JOINED)

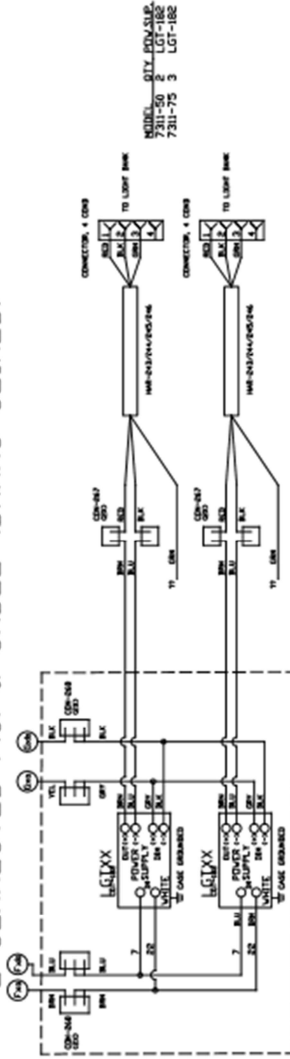

3 CONNECTED P.S. & CABLE (BANKS JOINED)

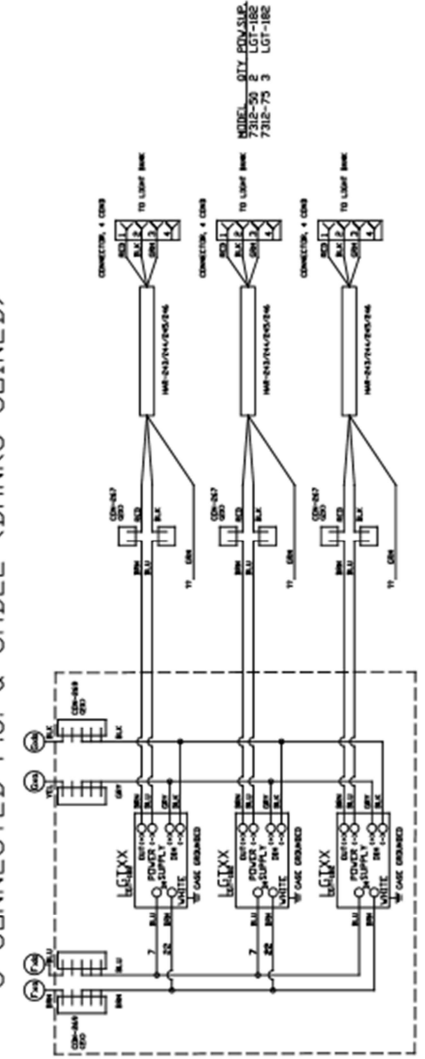

7310 SERIES ELECTRICAL SCHEMATIC (PAGE 5 OF 10) REV A

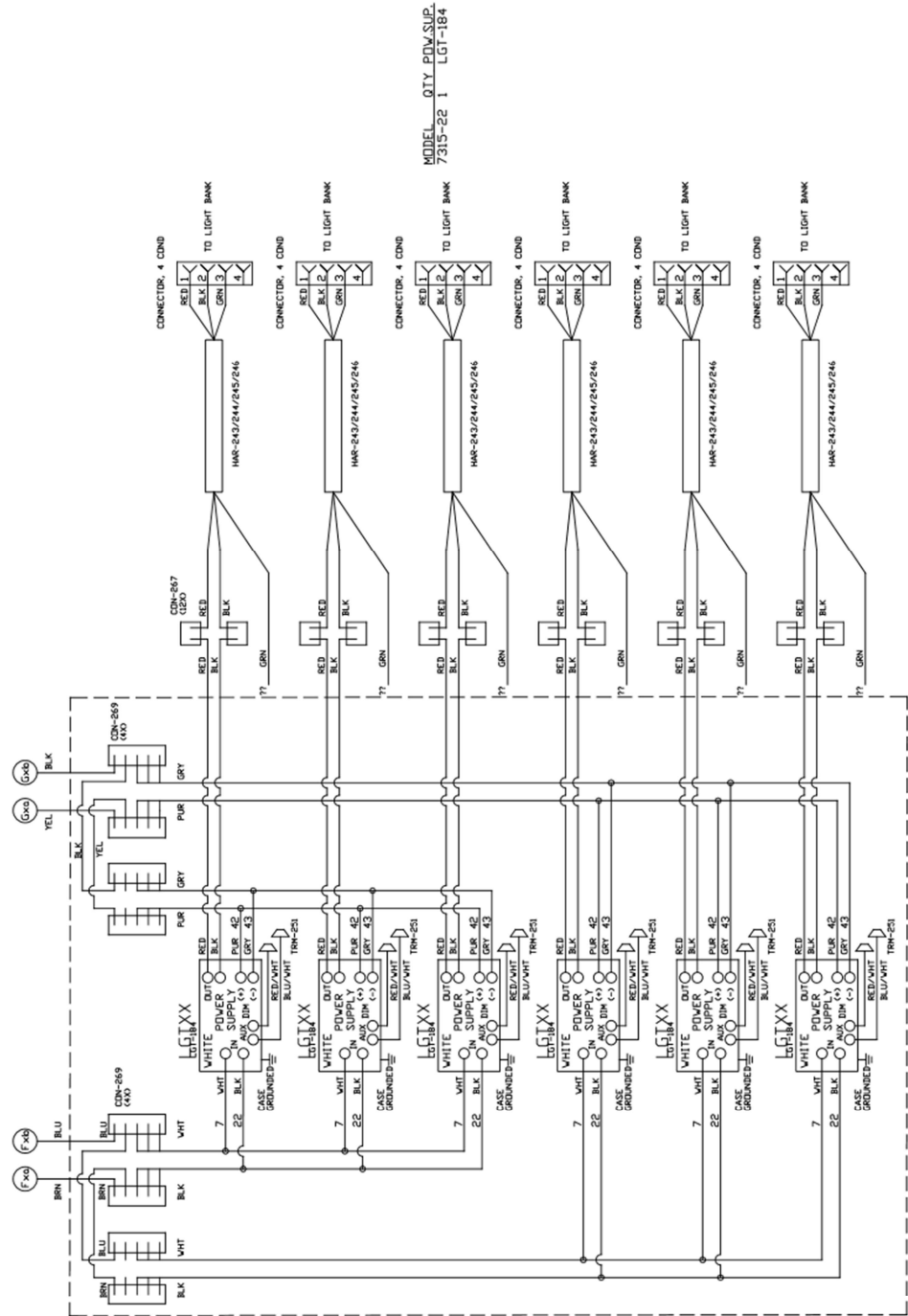

MODEL 7315-22 1 LGT-1B4

7310 SERIES ELECTRICAL SCHEMATIC (PAGE 6 OF 10) REV A

2 CONNECTED, 4 INDEP P.S. & CABLE (BANKS JOINED)

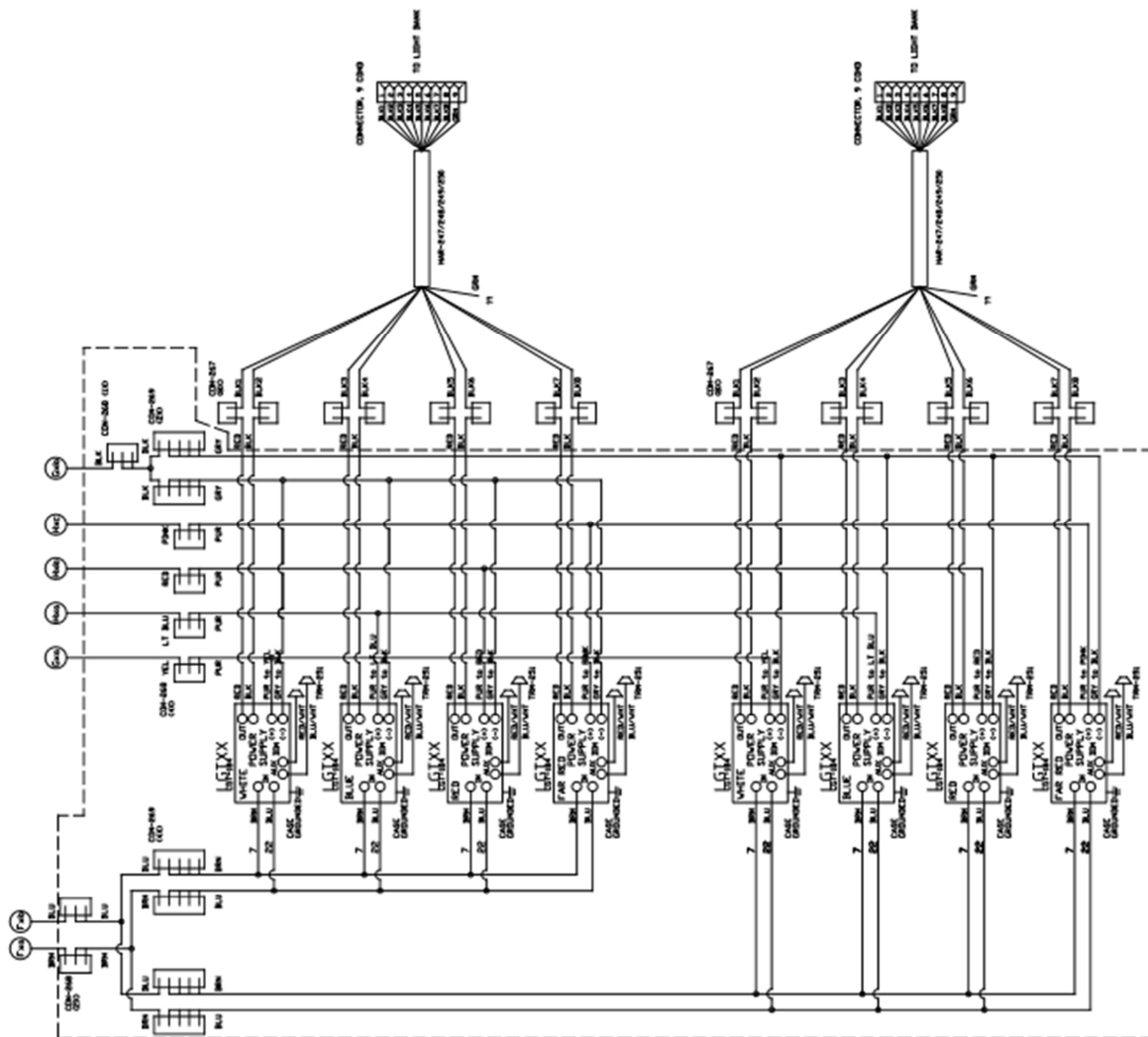

7310 SERIES ELECTRICAL SCHEMATIC (PAGE 7 OF 10) REV A

4 INDEPENDENT ADJ P.S. & CABLE LGT-184 (PER BANK)

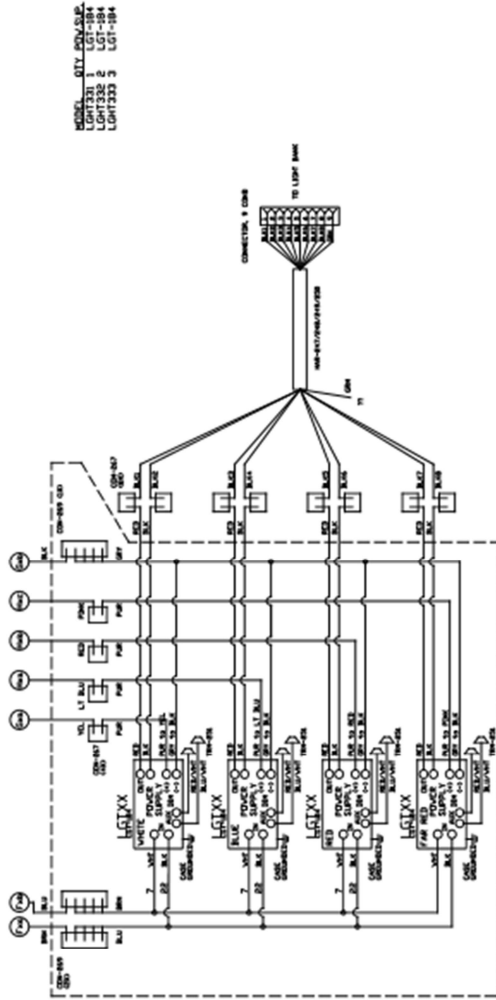

4 INDEPENDENT ADJ P.S. & CABLE LGT-182 (PER BANK)
LGT-184
LGT-185

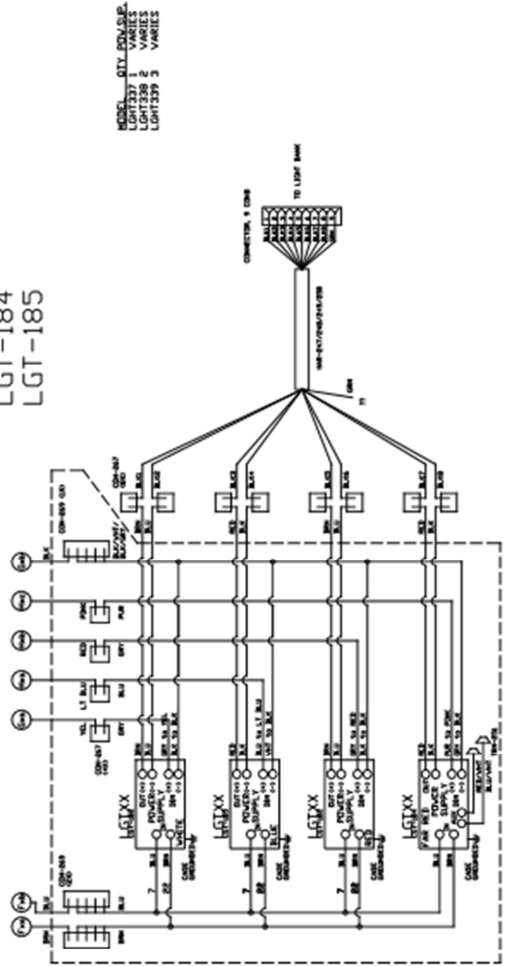

7314 SERIES ELECTRICAL SCHEMATIC (PAGE 8 OF 10) REV A

4 CONNECTED P.S. & CABLE (BANKS JOINED)

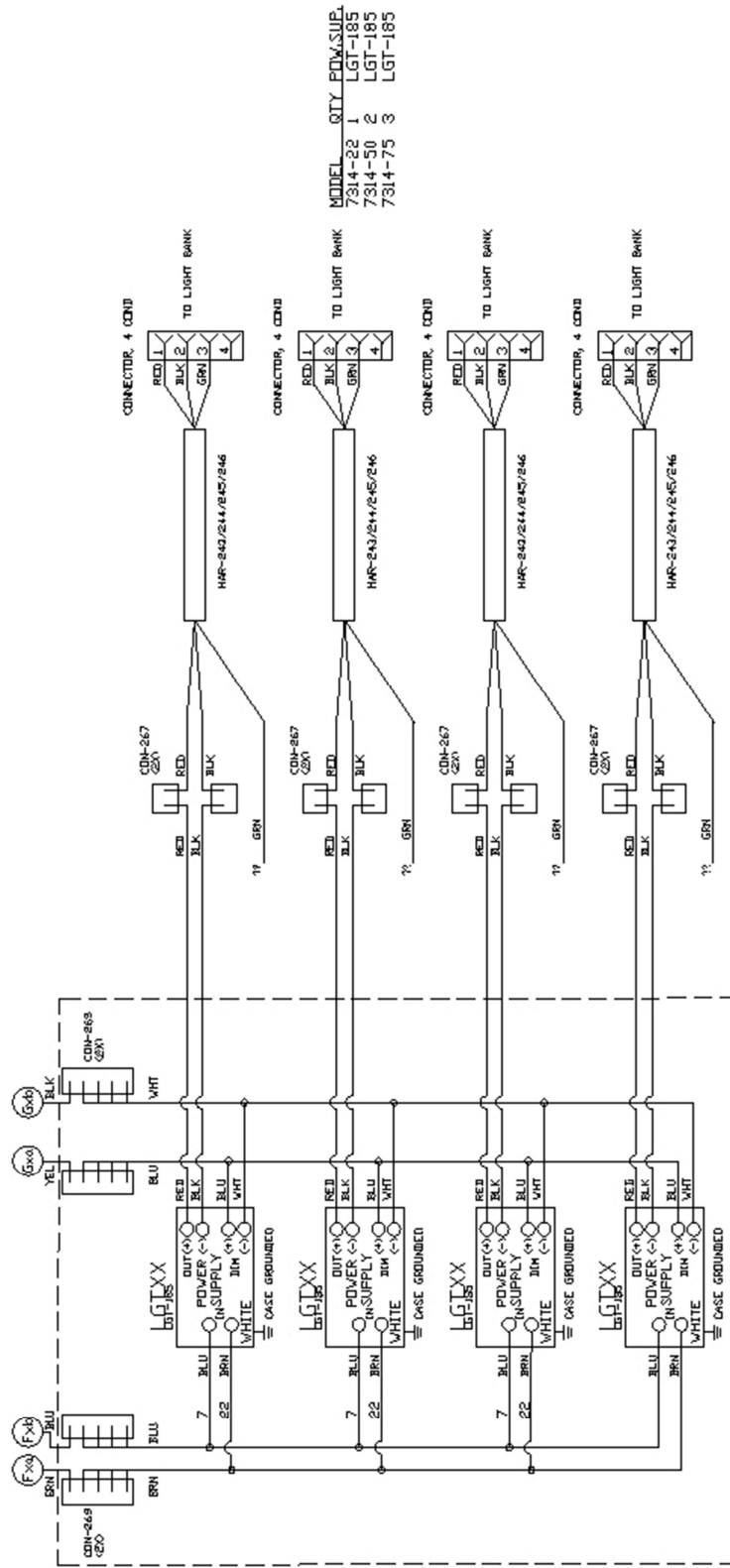

STANDARD - ONE DIMMING CIRCUIT (ALL WHITE LEDS)

7310, 11, 12

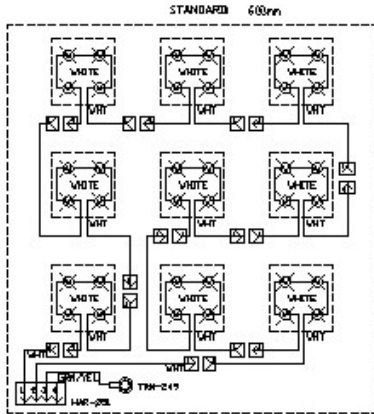

7310, 11, 12

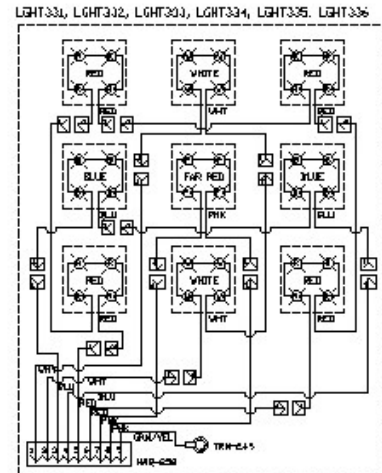

LIGHT329 (ONLY)

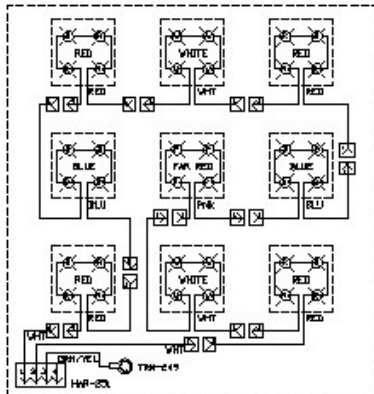

7314

STANDARD 300mA

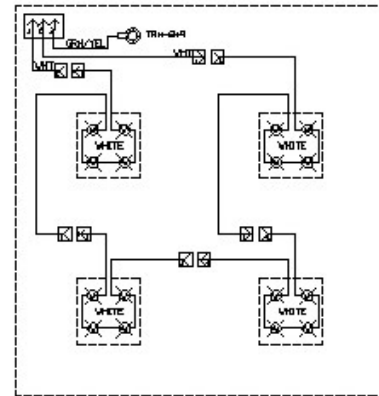

7315

STANDARD (AND OTHER OPTION) 150mA

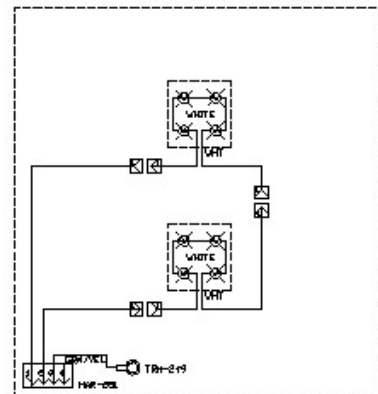

7317

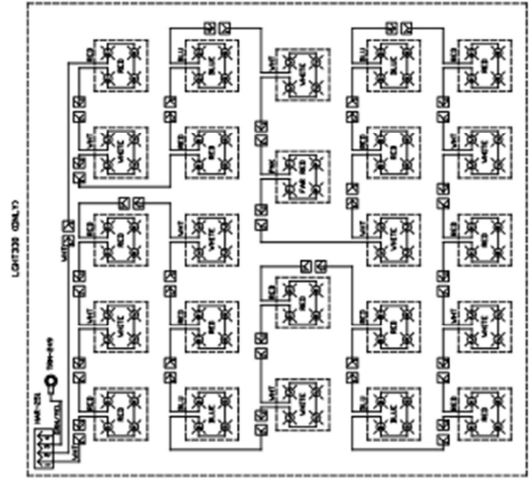
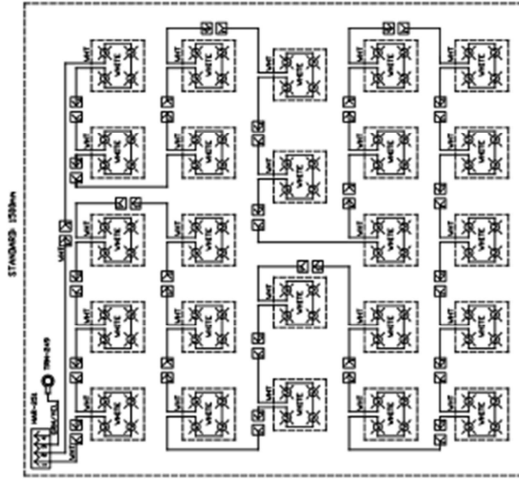
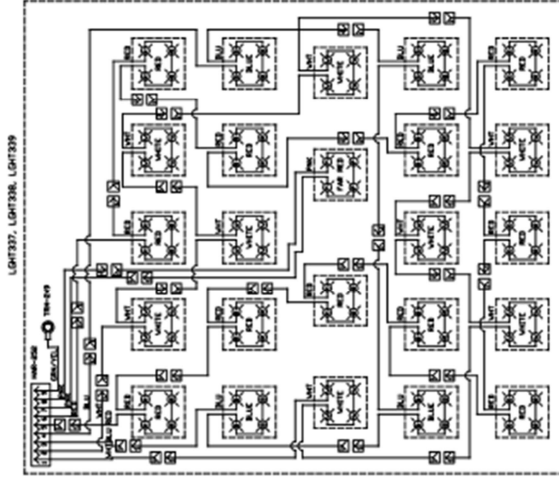

TROUBLESHOOTING

Problem -- Unit will not turn on

- Is the unit connected to a dedicated electrical circuit as defined in the installation section of the manual?
- Is there power at the electric outlet the unit is plugged into?
- Is the unit's power switch turned on?

Problem -- Unit temperature is above / below temperature setpoint

- Has the unit's temperature setpoint been recently lowered / raised and if so has the unit been allowed 12 hours stabilize at the new setpoint?
- Has the inner door been recently opened for an extended period of time?
- Is the access port stopper in the right side of the cabinet installed?
- Is the condenser filter on the front of the cabinet clean?

Unit humidity level is above / below humidity setpoint

- Is the unit connected to a water source as specified in the installation section of the manual?
- Has the unit been leveled to insure the cabinet drain works correctly?
- The cabinet's drain line uses gravity to remove water. Does the drain line have any rises in it above the cabinet's drain level that could be trapping water?
- Has the unit's humidity setpoint been recently lowered / raised and if so has the unit been allowed time to stabilize at the new setpoint?
- Has the door been recently opened for an extended period of time?
- Are the access port stoppers in the sides of the cabinet installed?
- Is the condenser filter on the front of the cabinet clean?
-

Problem – Light bank will not turn on

- Is the light bank connected to the light bank cable?
- Is the light bank turned off / disabled in the Light Cycle Menu/ Active Light Bank?
- Is the unit's power switch turned on?

SPARE / REPLACEMENT PARTS



CAUTION: Before servicing the unit, the mains power supply cord must be unplugged to avoid risk of shock. Any area of the unit that requires a tool to access shall only be serviced by trained personnel approved by Caron Products.



R290 REFRIGERANT UNITS

Do not damage the refrigeration circuit. Component parts shall be replaced with like components and servicing shall be done by authorized personnel to reduce the risk of possible ignition.

General

731X-22 Part Number	731X-50 Part Number	731X-75 Part Number	Description
FAN-135	MTR-139	MTR-139	Blower Motor
N/A	BLW-116	BLW-117	Blower Wheel
CTR-140	CTR-140	CTR-140	Main Controller Board
CTR-154	CTR-154	CTR-154	Light Controller Board
POW-115	POW-115	POW-115	24V DC Power Supply
CRD-113	N/A	N/A	Power Line Cord (115V 60Hz)
CRD-114	CRD-112	CRD-112	Power Line Cord (230V 60Hz)
CRD-104	CRD-108	CRD-108	Power Line Cord (230V 50Hz)
STP-101	STP-101	STP-101	2" rubber port stopper



The mains power supply cord must be replaced by the corresponding CRD part number above. The use of an inadequate mains power supply cord could result in equipment failure or personal harm to the user.

Temperature Related

731X-22 Part Number	731X-50 Part Number	731X-75 Part Number	Description
HTR-171	HTR-153	HTR-157	Air Heater
RMT-117	RMT-117	RMT-117	118C Air Heater Thermostat
RTD-101	RTD-101	RTD-101	Temp Sensor -- RTD 100 Ohm Platinum
CMP-134	N/A	N/A	115V / 60Hz Condensing Unit
CMP-135	CMP-138	CMP-138	230V / 60Hz Condensing Unit
CMP-135	CMP-138	CMP-138	230V / 50Hz Condensing Unit
SOL-147	SOL-147	SOL-147	Refrigeration Cooling Solenoid

Humidity Related

731X-22 Part Number	731X-50 Part Number	731X-75 Part Number	Description
HUM-110	HUM-110	HUM-110	RH Sensor
PMP-150	PMP-150	PMP-150	24VDC RH Pressure Pump
NOZ-101	NOZ-101	NOZ-101	Precision RH Spray Nozzle
SOL-147	SOL-147	SOL-147	Dehumidification Solenoid
SOL-135	SOL-135	SOL-135	Humidification Solenoid
TUB-183	TUB-183	TUB-183	Drain Tubing, Black, 1/2" OD
TUB-132	TUB-132	TUB-132	Water Supply Tubing, Black, 1/4" OD

Light Related

731X-22 Part Number	731X-50 Part Number	731X-75 Part Number	Description
LGT-182	LGT-182	LGT-182	LED power supply
LGT-183	LGT-183	LGT-183	LED power supply
LGT-184	LGT-184	LGT-184	LED power supply
LGT-185	LGT-185	LGT-185	LED power supply
LGT-210	LGT-210	LGT-210	Light Detector

Fuse Related

NOTE: All fuses are slow blow

731X-22 Part Number	731X-50 Part Number	731X-75 Part Number	Description
CBR-116	N/A	N/A	115V Main circuit breaker switch
CBR-115	CBR-116	CBR-116	230V Main circuit breaker switch
FUS-163	N/A	N/A	115V Heater fuse
FUS-163	FUS-103	FUS-164	230V Heater fuse

Options Related

Part Number	Description	Option
LGT-182	Led power supply	LGHT337,338,339
LGT-183	Led power supply	LGHT337,338,339
LGT-184	Led power supply	LGHT331-LGHT339
LGT-185	Led power supply	LGHT337,338,339
MEM-103	USB Flash Drive	DLOG301
PEN-103	Red pen for 6 inch recorder	RCDR316, RCDR317
PEN-104	Blue pen for 6 inch recorder	RCDR317
PPR-104	6 inch recorder paper, 7 day 0-60C	RCDR316
PPR-105	6 inch recorder paper, 7 day 0-100C	RCDR317
PPR-106	10 inch recorder thermal paper	RCDR318, RCDR319
TUB-145	1/4" I.D. tubing	PUMP301
WIR-102	20/3 conductor shielded wire	ALRM302

APPENDIX A – Dehumidification Performance (HUMD312, 313, 314)

Plant growth chambers with optional humidity control (HUMD312, HUMD313 and HUMD314) have the ability to control the humidity level inside the chamber by adding or removing moisture in the air. There are other factors that influence the humidity level inside the chamber which the user should be aware of.

Relative Humidity

Relative humidity refers to the air's moisture carrying capacity at a specific temperature. The maximum relative humidity level is 100%. The higher the temperature, the more water the air can hold. For example, air at 15°C can carry 74 grains of moisture per pound of dry air. Air at 25°C can hold 140 grains of moisture per pound of dry air. When the air temperature drops, it is unable to carry as much water. And when the temperature is below the dew point, excess water will condense out of the air.

When the plant growth chamber set point is higher than the humidity level, the air's humidity is increased by injecting water into the air via a system of atomizers. Conversely, when the chamber set point is lower than the chamber's humidity level, then moisture is taken out of the air by means of a mechanical refrigeration evaporator.

However, because relative humidity is dependent on temperature, a change in temperature by itself (without changing the moisture content) also changes the (relative) humidity level. This phenomenon can be seen when transitioning from day to night (and visa versa). For example, if the day temperature is 22C with a 65% relative humidity and the night temperature is 18C, then natural resultant humidity level at night will be 83%. Active dehumidification is needed to lower the humidity from 83% to the desired 65% during the night.

Indirect effect of heat from lights on humidity

Lights themselves give off convection and radiant heat. The first impact this has is to raise the air temperature. As the immediate air temperature increases, the relative humidity resultantly decreases. Caron chambers provide stable and gentle forced air movement to maintain a uniform environment. The circulating air is also cooled to offset the effects of heat radiating from the lamps. During this cooling process, the mechanical refrigeration evaporator naturally condenses moisture from the air. This humidity loss is made up for by the chamber automatically injecting compensating water.

The effect of lights on humidity can most easily be seen during a day to night transition. This sequence of events will follow: the lights turn off, the heat generated by the lights goes away, the cooling system no longer removes moisture from the air, and the result is

a temporary increase in the humidity level. The chamber will engage the dehumidification system, but the recovery takes time.

Mimicking the real world

While specific conditions vary throughout the natural world, there is still a gradualness of changing from day to night and back to day. These light, temperature, and humidity fluctuations in nature occur over several hours. Being consistent with that, the Caron plant growth chambers also take some time to adjust. When programming the light cycle (see Controlling the Light section), a gradual feature can be selected which gradually changes the set point over a 30 minute duration. Also, a typical day/night transition could take up to 2 hours for the humidity to reach back within 5% of set point. Humidity changes in the case of extreme day/night transitions can take even longer. The optional dryer package (part number DRYR301) can accelerate the humidity recovery.

Impact of watering methods

In the natural world, humidity levels tend to run higher in regions near a large body of water such as a lake or ocean. In the same way, how plants are watered influences the chamber's relative humidity. Water will naturally evaporate from moist soil and increase the humidity level. The more plant watering and wet soil surface exposed, the more the humidity increase will be. A watering method which results in saturating large portions of exposed soil may not be compatible with low chamber air humidity levels.

Arabidopsis Example

A common day/night simulation for growing Arabidopsis is the following conditions:

- Day: Temperature 22C, humidity 65%, 200 $\mu\text{mole/m}^2/\text{s}$ of light
- Night: Temperature 18C, humidity 65%, lights off

The watering condition for this example is 3.8 ft² of exposed saturated soil.

Below is an example showing the temperature and humidity air measurements inside a Caron plant growth chamber. The first 8 hours are the day, then 8 to 16 hours is the night, and at 16 hours the transition turns back to day.

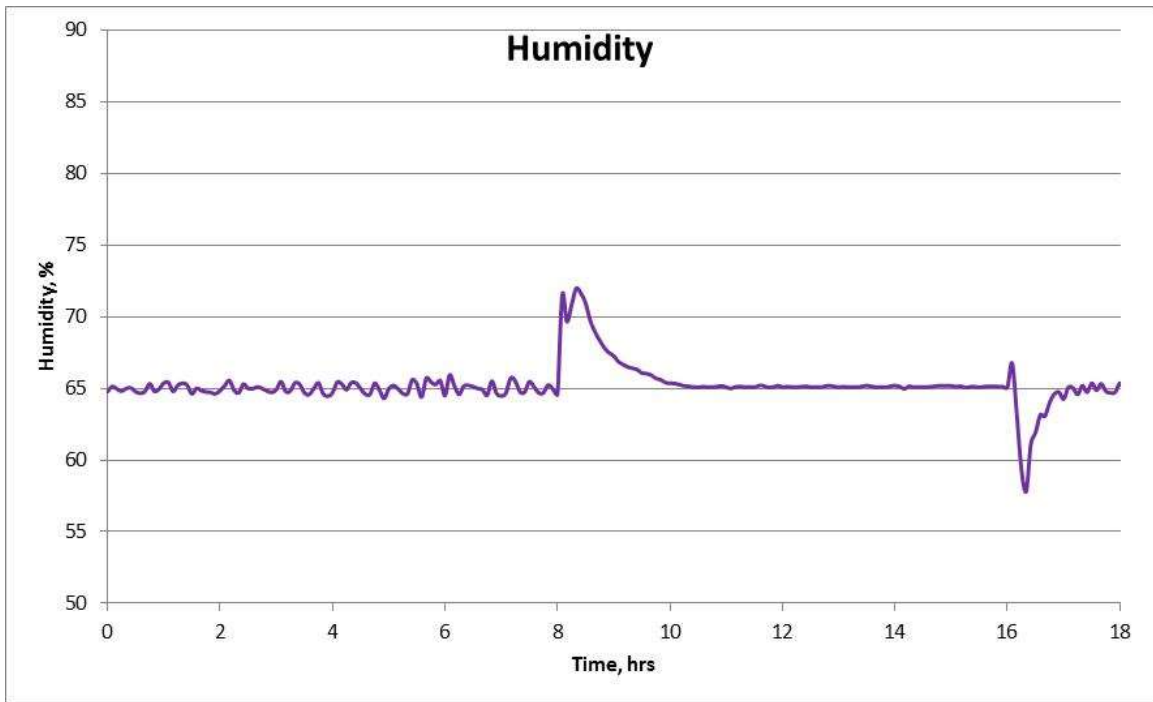
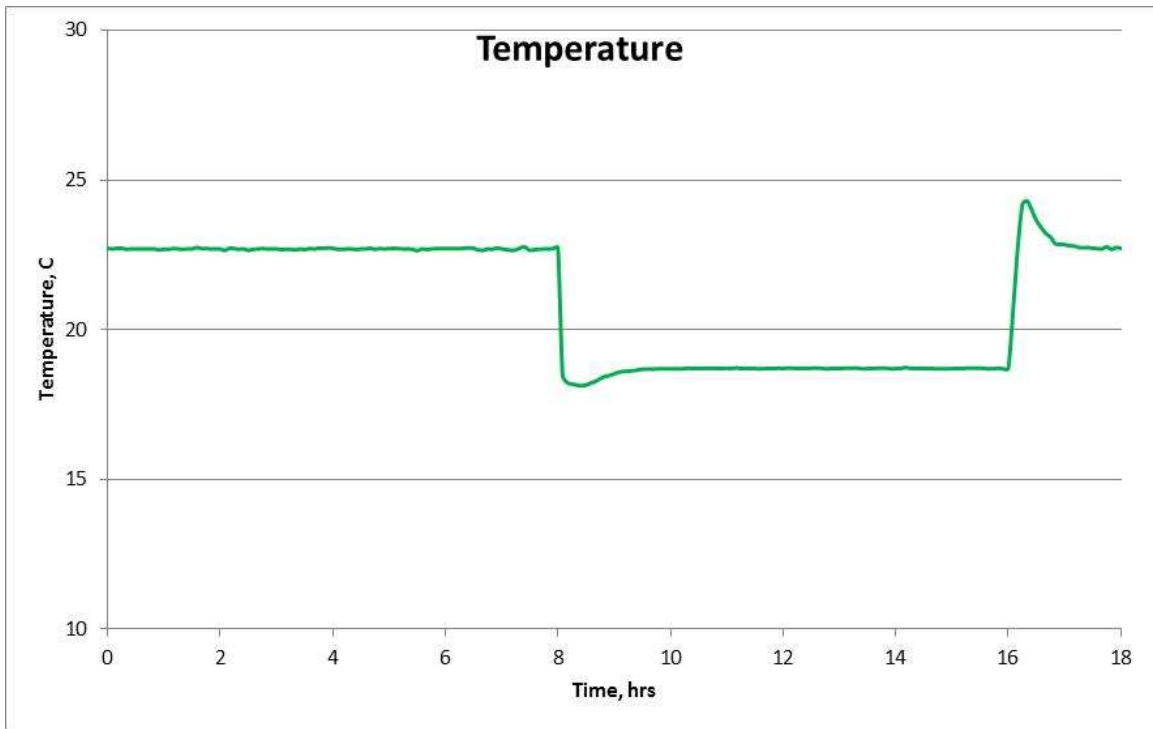

Extreme Example

A more extreme set of day/night conditions is shown in the illustration below:

- Day: Temperature 25C, humidity 75%, 470 $\mu\text{mole}/\text{m}^2/\text{s}$ of light
- Night: Temperature 18C, humidity 75%, lights off

The watering condition for this example is 7.6 ft^2 of exposed saturated soil.

Below is an example showing the temperature and humidity air measurements inside a Caron plant growth chamber. The first 8 hours are the day, then 8 to 16 hours is the night, and at 16 hours the transition turns back to day.

