



Caron Products & Services
OPERATIONS MANUAL



CO₂ INCUBATOR

*Models: 7400-25 / 7400-33
7401-25 / 7401-33*

Dear Valued Customer:

Thank you for purchasing CARON Products & Services equipment. We appreciate your business and look forward to being your preferred supplier of controlled environment equipment products in the future.

At CARON, we are committed to continuous quality improvement. Our goal is to supply our customers with highly reliable equipment at a fair price. In order to openly monitor our performance, we would appreciate your feedback on our products and services.

If you have questions, or any suggestions for improvement based on the installation or operation of the equipment you have purchased, please contact our service department at www.caronproducts.com or 740-373-6809.

Thanks again for your business!

Revision Log

Version	Date	Description
Rev A	10-2-14	Initial Release
Rev B	2-24-15	Added DLOG301 section
Rev F	09-07-16	Increased alarm delay for humidity from 15 minutes to 45 minutes
Rev G	10-03-16	Added information to the preventative maintenance section
Rev H	08-14-17	Updated consistency between all manuals
Rev J	11-13-17	Added LTCH301/LTCH302 section
Rev K	02-13-18	Changed chamber drain tubing interface
Rev L	03-08-18	Updated Co2 connection pic, added shaker specs limitations.
Rev M	04-03-18	Shaker info update
Rev N	05-17-18	HEPA filter info removed for CO2
Rev P	07-17-18	Updated PM Kit info
Rev Q	05-14-19	Added analog output adjustable temperature range feature.
Rev R	11-05-19	Normalized all CO2 pressures to 20-25 PSIG
Rev S	1-20-20	Updated for flammable refrigerant
Rev T	1-21-21	Added adjustable alarm delay
Rev U	03-31-21	updated Declaration of Conformity document
Rev V	04-13-21	updated Declaration of Conformity document
Rev W	05-07-21	Updated model numbers, removed DECN301 option. Added thin pilaster features.
Rev X	07-01-21	Added CLEN301-304, WALL301-306 options
Rev Y	11-03-21	Updated pictures of Analog Outputs and Remote Alarm Contacts
Rev Z	12-30-21	Added UKCA Declaration of Conformity

TABLE OF CONTENTS

Warranty	6
Equipment Overview	10
Installation	12
Unpacking	
Choosing a Location	
Preliminary Cleaning	
Installing the Port Stopper	
Installing the Shelves	
Leveling the Unit	
Connecting the Drain Line	
Water Supply for Humidity	
Connecting CO ₂ supply	
Connecting Electrical Power	
Cell Roller / Reinforced Shelf	
Optional Accessory Installation	22
Connecting Alarm Contacts (ALRM302)	
Installing Carboy water system (BOTL301)	
Connecting to Humidity (HUMD304, HUMD307)	
Connecting Analog Outputs (OUTP302, OUTP303)	
Install a Drain Water Pump (PUMP301)	
Install in a Wall - Trim Kits (WALL301/302)	
Operation	29
Using the Keypad	
Learning the Screen Saver	
Changing the Temperature Setpoint	
Changing the Humidity Setpoint	
Changing the CO ₂ Setpoint	
Optional Accessory Operation	38
Carboy water system (BOTL301)	
Cleanroom Wipe down (CLEN301/302/303/304)	
Operation of the Data Logging System (DLOG301)	
Using the Extended Temperature Range (EXTD302)	
Built in Gas Guard System (GASG302)	
Ultraviolet Germicidal Lamp (LGHT602)	
Interior Electrical Outlet (OUTL305-OUTL330)	
Built in Temp or Temp/Rh 6" Pen Recorders (RCDR316/RCDR317)	
Built in Temp or Temp/Rh 10" Thermal Recorders (RCDR318/RCDR319)	
H ₂ O ₂ sterilization cycle (STER305)	
Door Latch (LTCH301/LTCH302)	

Calibration	60
Calibrating Temperature	
Calibrating Humidity	
Calibrating the CO ₂	
Alarms	64
Alarm System Overview	
Snoozing the Speaker	
Muting the Speaker	
Changing Alarm Setpoints and Delay	
Alerts	72
Alert System Overview	
Maintenance	
Info	75
Info System Overview	
Advanced Features	76
Setting the Time & Day	
Door Heat	
Humidity Control	
Locking the controls	
Changing the Passcode	
Factory menu & troubleshooting	
Preventative Maintenance	92
Specifications	94
Electrical Schematics	96
Troubleshooting	105
Spare Replacement Parts	106
Appendix A – Declaration of Conformity	109

WARRANTY INFORMATION

CO₂ INCUBATOR LIMITED WARRANTY

Please review this section before requesting warranty service. At CARON, one of our primary goals is to provide customers with high levels of personal service and top quality products, delivered on time, backed by technical service and supported for the life of the product.

Before contacting us for warranty service, please be aware that there are repairs that are not covered under warranty.

WARRANTY DEFINED

Caron Products & Services, Inc. (herein after CARON) hereby warrants that equipment manufactured by CARON is free from defects in materials and workmanship when the equipment is used under normal operating conditions in accordance with the instructions provided by CARON.

COVERED:

- Parts and labor for a period of two (2) years from date of shipment.
- Any part found defective will be either repaired or replaced at CARON's discretion, free of charge, by CARON in Marietta, OH. Parts that are replaced will become the property of CARON.
- If CARON factory service personnel determine that the customer's unit requires further service, dependent of the model involved, CARON may, at its sole discretion, provide a service technician to correct the problem, or require the return of the equipment to the factory or authorized service depot.
- CARON will have the right to inspect the equipment and determine the repairs or replacement parts necessary. The customer will be notified, within a reasonable time after inspection, of any costs incurred that are not covered by this warranty prior to initiation of any such repairs.

NOT COVERED:

- Calibration of control parameters.
- Improper installation; including electrical service, gas and water supply tubing, gas supplies, room ventilation, unit leveling, facility structural inadequacies or ambient conditions that are out of specification.
- Cost of express shipment of equipment or parts.
- Any customer modifications of this equipment, or any repairs undertaken without the prior written consent of CARON, will render this limited warranty void.
- CARON is not responsible for consequential, incidental or special damages; whether shipping damage or damages that may occur during transfer to the customer's point of use. When the equipment is signed for at the customer's site, ownership is transferred to the customer. Any damage claims against the shipping company become the responsibility of the customer.
- Repairs necessary because of the equipment being used under other than normal operating conditions or for other than its intended use.
- Repair due to the customer's failure to follow normal maintenance instructions.
- Parts considered consumable; including: light bulbs, filters, gases, etc.
- Damage from use of improper water quality.
- Damage from chemicals or cleaning agents detrimental to equipment materials.
- Force Majeure or Acts of God.

This writing is a final and complete integration of the agreement between CARON and the customer. CARON makes no other warranties, express or implied, of merchantability, fitness for a particular purpose or otherwise, with respect to the goods sold under this agreement. This warranty cannot be altered unless CARON agrees to an alteration in writing and expressly stated herein shall be recognized to vary or modify this contract.

Ohio Law governs this warranty.

EQUIPMENT INTERNATIONAL LIMITED WARRANTY

Please review this section before requesting warranty service. At CARON, one of our primary goals is to provide customers with high levels of personal service and top quality products, delivered on time, backed by technical service and supported for the life of the product.

Before contacting your distributor for warranty service, please be aware that there are repairs that are not covered under warranty.

WARRANTY DEFINED

Caron Products & Services, Inc. (herein after CARON) hereby warrants that equipment manufactured by CARON is free from defects in materials and workmanship when the equipment is used under normal operating conditions in accordance with the instructions provided by CARON.

COVERED:

- Parts for a period of two (2) years from date of shipment.
- Any part found defective will be either repaired or replaced at CARON's or their authorized representative's discretion. Parts that are replaced will become the property of CARON.
- If CARON or their authorized representatives determine that the customer's unit requires further service, CARON or the representative may, at its sole discretion, provide a service technician to correct the problem, or require the return of the equipment to the an authorized service depot.
- CARON or their authorized representative will have the right to inspect the equipment and determine the repairs or replacement parts necessary. The customer will be notified, within a reasonable time after inspection, of any costs incurred that are not covered by this warranty prior to initiation of any such repairs.

NOT COVERED:

- Calibration of control parameters.
- Improper installation; including electrical service, gas and water supply tubing, gas supplies, room ventilation, unit leveling, facility structural inadequacies or ambient conditions that are out of specification.
- Cost of express shipment of equipment or parts.
- Any customer modifications of this equipment, or any repairs undertaken without the prior written consent of CARON, will render this limited warranty void.
- CARON and their representative are not responsible for consequential, incidental or special damages; whether shipping damage or damages that may occur during transfer to the customer's point of use. When the equipment is signed for at the customer's site, ownership is transferred to the customer. Any damage claims against the shipping company become the responsibility of the customer.
- Repairs necessary because of the equipment being used under other than normal operating conditions or for other than its intended use.
- Repair due to the customer's failure to follow normal maintenance instructions.
- Parts considered consumable; including: light bulbs, filters, gases, etc.
- Damage from use of improper water quality.
- Damage from chemicals or cleaning agents detrimental to equipment materials.
- Force Majeure or Acts of God.

This writing is a final and complete integration of the agreement between CARON and the customer. CARON makes no other warranties, express or implied, of merchantability, fitness for a particular purpose or otherwise, with respect to the goods sold under this agreement. This warranty cannot be altered unless CARON agrees to an alteration in writing and expressly stated herein shall be recognized to vary or modify this contract.

Ohio Law governs this warranty.

Caron Products & Services, Inc.
PO Box 715 · Marietta, OH 45750
740-373-6809

INTERNATIONAL SYMBOLS AND DEFINITIONS



Help



Information



Warning of hazardous area



Warning of hot surface



Warning of dangerous electric voltage



Warning of risk of fire



Earth (ground) protective conductor

WARNINGS



Local government may require proper disposal

TO LOCATE REFRIGERANT TYPE AND PRESSURES, SEE SERIAL LABEL LOCATED ON THE OUTSIDE OF THE UNIT

FOR HYDROCARBON (R290 PROPANE) REFRIGERANT UNITS

R290 is highly flammable and must be treated with proper care.



Do not damage the refrigeration circuit. Do not store explosive substances in the unit. Component parts shall be replaced with like components and servicing shall be done by authorized personnel to reduce the risk of possible ignition.



DANGER – Flammable Refrigerant Used. Risk of fire or explosion.

- Do not puncture refrigerant tubing
- Do not use mechanical devices to defrost refrigeration equipment
- Unit to be repaired only by trained service personnel



CAUTION – Flammable Refrigerant Used. Risk of fire or explosion.

- Consult repair manual, owners guide before attempting to service this product. All safety instructions must be followed.
- Dispose of properly in accordance with federal or local regulations.



CAUTION – Do not use any electrical appliance within the Environmental Chamber, other than those recommended by the manufacturer.

EQUIPMENT OVERVIEW

Congratulations! You have just purchased the latest technology in CO₂ incubators. Before using the equipment, familiarize yourself with key components of the product and thoroughly read this manual.



Model 7400-25

The following incubator models have pre-configured internal shelving and brackets tailored for particular applications used in cell culturing:

- 7401-25/33 Multi-Tier Shaker Ready CO₂ Incubators
- CELL301/302 Cell Roller Ready CO₂ Incubators
- CELL303/304 Shaker / Cell Roller Ready CO₂ Incubators

EQUIPMENT OVERVIEW – CONTINUED

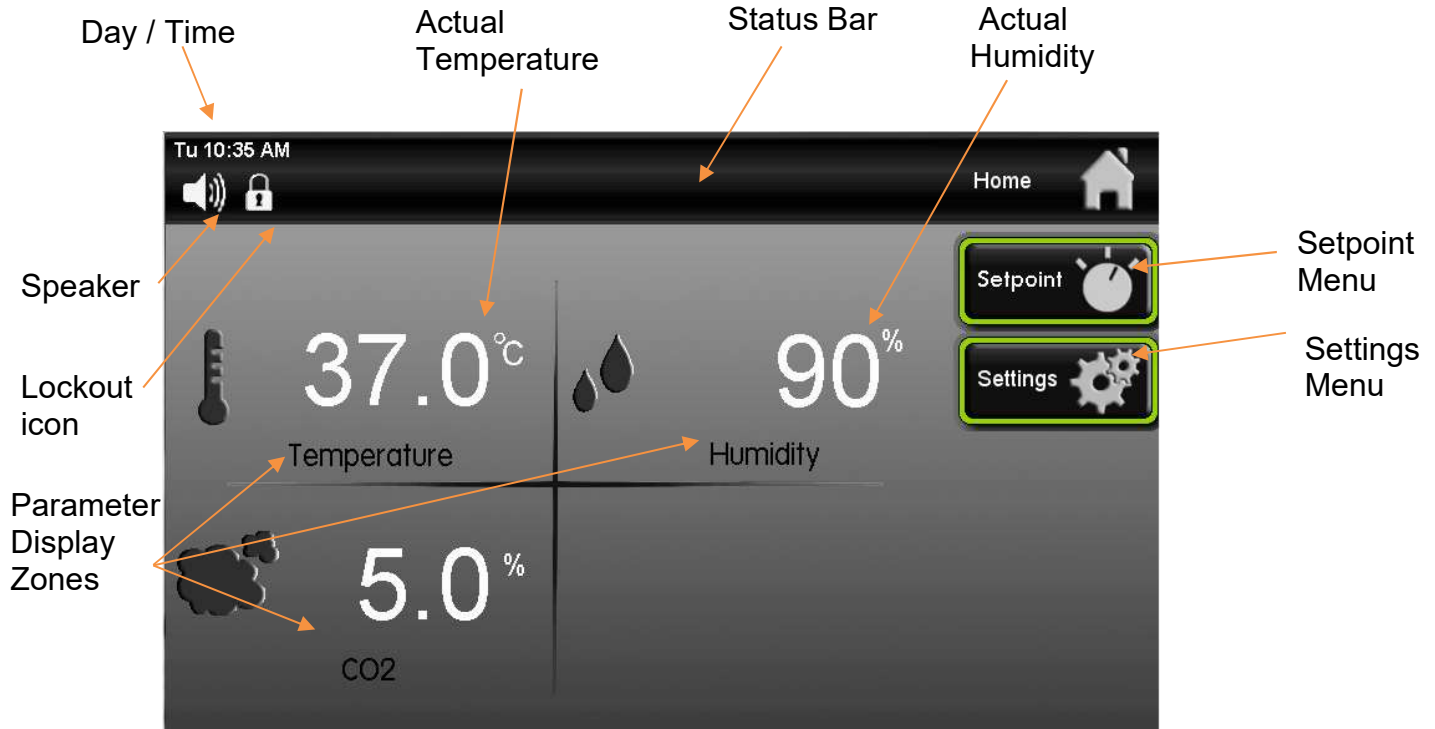

(Home Screen)

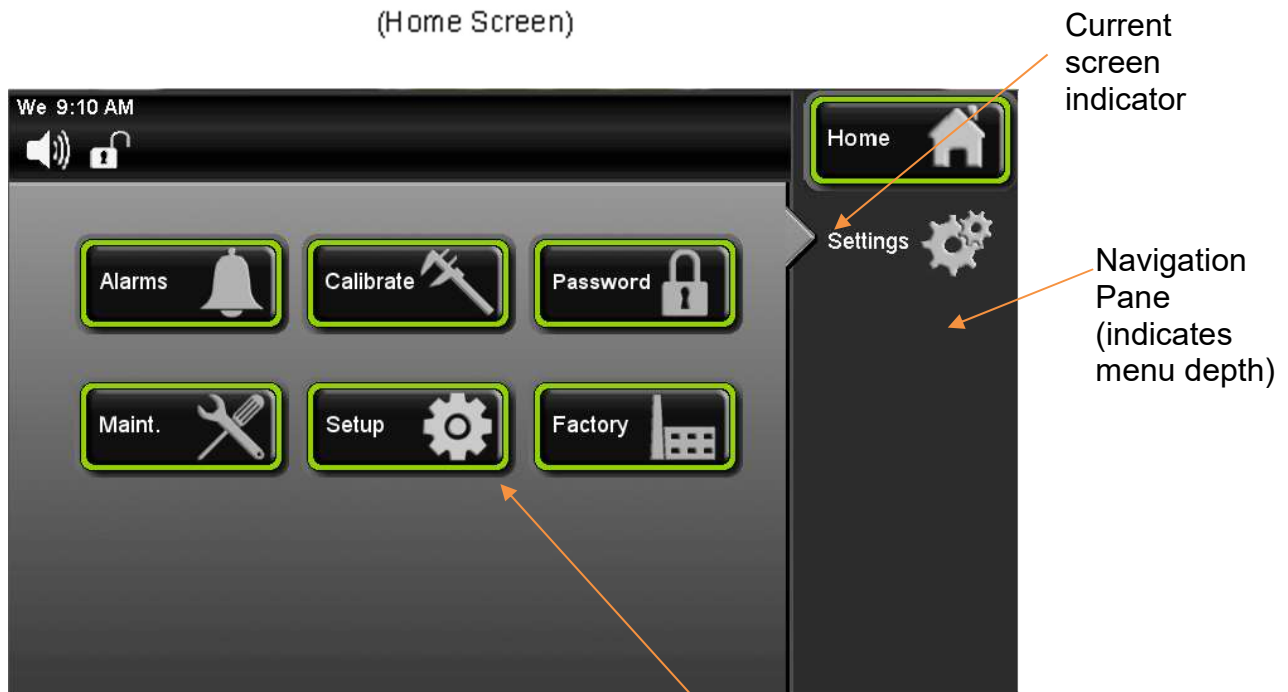

(Settings Screen)

INSTALLATION

Unpacking

Your new unit has been thoroughly packaged to avoid shipping damage. However, the unit should be fully inspected upon arrival before signing for receipt. If the package has visual damage, notes should be made on the freight bill and signed by the delivery company. In the event of concealed damage after the unit is uncrated, keep the carton and packaging material. Call the shipping company within 7 days of receipt, request inspection and retain a copy of the inspection report.

For prolonged periods of inactivity leave the unit unplugged and securely stored.

Caron provides full on-site installation services for all models. Our installation services guarantees the proper set-up and startup of all equipment. Please contact the Service Department at 740-373-6809 or www.caronproducts.com for details.

Choosing a Location



This product weighs in excess of 500 pounds. Ensure that sufficient resources are available to safely move the product.

To ensure proper operation, the unit must be located on a firm level surface, capable of supporting approximately 800 pounds. The unit should be located in an 18°C – 25°C ambient area and where there is no direct airflow from heating and cooling ducts as well as out of direct sunlight. Allow four inches of clearance on all sides of the product to allow for connections and airflow. The unit is designed to be used under the following conditions.

- Indoor use only
- Altitude up to 2000m.
- Maximum relative humidity: non-condensing
- Mains supply voltage fluctuations up to +/- 10% of the nominal voltage; damage may occur if voltage varies more than 10%
- Transient overvoltages up to the levels of overvoltage category II
- Temporary overvoltages occurring on the mains power supply
- Pollution degree: 2
- Ingress protection: IPXO

The unit requires a dedicated electrical connection. Depending on the options purchased with unit a floor drain may be required. Choose a location where these facilities are or can be made available. If a water source, or a drain is not available, contact CARON customer service and ask about our CRY5102 product line or click this web link for information on the product:

www.caronproducts.com

Preliminary Cleaning

Your new environmental chamber was thoroughly cleaned prior to leaving the factory. It is recommended, however, to clean all interior surfaces with a general purpose laboratory cleaning agent to remove any shipping dust or dirt prior to using the product. Contact Caron if there is any doubt of the compatibility of the cleaning agent being used with the chamber. After cleaning, dry all interior components with a sterile cloth as necessary.

Installing the Port Stoppers

The unit has an access port built into each side of the cabinet. The ports are designed to allow customer access for equipment validation or for installation of other equipment inside the chamber. These ports should be sealed with the provided rubber stoppers to allow the incubator to function properly. Install the stoppers provided in the port on each side of the unit.



R290 REFRIGERANT UNITS

DANGER – Flammable Refrigerant Used. Risk of fire or explosion.

- No equipment that uses an open flame should be placed inside the unit.
- Do not use instrumentation or equipment that incorporates potential ignition sources, e.g. open contact switching, brushed DC and AC motors, etc.
- Do not use electrical appliances within the unit, other than those recommended by the manufacturer.



Installing the Shelves

Models 7400-25 / 33 incubators include sliding perforated stainless steel shelves. Each shelf requires two shelf channels for installation. Prior to installation, take time to consider what the size of the product being placed in the incubator will be and set the shelf spacing accordingly. Additional shelving can be purchased through CARON customer service if necessary.

To install the shelf channels slide on end of the shelf track into the appropriate shelf location in the rear plenum. Hook the front of the shelf track into the corresponding location on either the right or left side front shelf support pilaster. Repeat the process on the opposite side of the incubator.

Models 7401-25/33 have thin pilaster and reinforced shelving for larger shakers.





Shelf capacity: each perforated shelf is capable of supporting a uniformly distributed load of 50 lbs, maximum chamber capacity is 500 pounds (stationary).

Standard shelving not suitable for shakers over the weight of 30lbs, and have a .75" orbit.

Optional reinforced shelving is available for supporting heavy loads such as shakers or cell rollers up to 150lbs.

Max shaker speed with reinforced shelves is 250 RPM.

Chamber should be empty when being moved.



Do not pull multiple loaded perforated shelves out simultaneously or the chamber may tip.

Leveling the Unit

Place a level on the middle shelf of the incubator. Adjust the feet until the unit sits level left to right and front to back. Even if the unit is level without adjustment, the leveling feet should still be lowered to avoid the cabinet moving while opening and closing the outer door & prevent a flat spot from forming on the casters.



Connecting the Drain



When using a pressurized water source, failure to connect the unit to a drain could result in facility flooding.



The chamber drain connection is located in the bottom middle of the back of the chamber. A 3/8" tube fitting, tubing and wire ties are supplied in the unit parts kit. Insert the tube fitting into the tubing, secure tubing to fitting with provided wire tie. Insert fitting into drain connection. Pull on the tubing after installation to make sure it is secure. Route the drain tubing to a local floor drain. Duplicate fitting installation on other end of tubing if necessary.



The drain line relies on gravity to remove water from the chamber. The drain line must remain below the chamber to drain properly. Kinks or elevations in the drain line above the cabinet drain will not allow the chamber to drain.

If a local floor drain is not available, a variety of accessories are available through CARON customer service. These accessories can also be viewed at www.caronproducts.com

Models 7401-25/33 are non-humidified chambers and have a 1/2" plug installed into the drain connection. The drain will be required when a humidity option is purchased with the chamber.

Fill water pan (also HUMD305, HUMD306)



Use only distilled or deionized water with a resistivity between 50K Ω -CM and 1M Ω -CM and a pH of greater than 6.5. Using water outside this range will void your warranty.



Do not use water that contains chloramines. Chloramines can damage internal rubber gaskets resulting in leaks.

A water pan is used to provide elevated humidity levels inside the incubator. This feature is standard on 7400 models (and optional for the others). Using the handles provided, remove the empty water pan from the bottom of the incubator. Fill with 5 to 6 liters of water. Re-insert water pan back into the incubator.

Connecting a CO₂ supply



High concentrations of carbon dioxide can cause asphyxiation. The use of CO₂ monitors and alarms is recommended for areas where CO₂ can collect.



The CO₂ gas supply should be 99% pure and should not contain a siphon tube. Gas pressure to the unit must be regulated to 20-25 PSIG. Failure to do so could cause tubing to burst.



The CO₂ supply should be 99% and not have siphon tubes. CO₂ pressure should be regulated to 20-25 PSIG. CO₂ tank regulators REGL101 can be purchased through CARON customer service. Once the cylinder regulator is installed, connect the outlet of the regulator to the hose barb fitting using the tubing and clamps provided.



An inline filter is provided to remove any contaminants in the CO₂ gas supply. Check the connections closely for leaks.

If the unit is equipped with a built in gas guard system GASG302, there will be 2 gas inlets. Each of the inlets should be connected to an individual gas tank as described above.

Connecting Electrical Power



Connect each incubator to a grounded circuit. Failure to do so could result in electrical shock.

The unit requires a dedicated electrical outlet. See table below for model specific power required and connection.

Model #	Power Requirements	Plug Connection
-1	115V, 60Hz, 16A FLA	NEMA 5-20
-2	230V, 60Hz, 10A FLA	NEMA 6-15
-3	230V, 50Hz, 8A FLA	CEE 7/7

When the required electrical connection is available, plug the provided power cord into the unit and the electrical outlet.



The mains power supply cord must meet the requirements listed above. The use of an inadequate mains power supply cord could result in equipment failure or personal harm to the user.



In the event of a power outage the unit will automatically restart when the power is restored.

Cell Roller Ready (CELL301,302,303,304)

These models have a cell roller, a reinforced floor, cell roller ramp, and interior outlet. These models were designed to hold a 3, 5 or 7 tier Wheaton R2P cell roller.

Support braces have tracks to guide the cell roller wheels into the incubator. The cell roller ramp has small tabs at the end that fit into an opening at the end of each cell roller support brace.

The ramp is designed to support the weight of the cell roller as it is pushed into the incubator. Once the cell roller is pushed into the incubator, remove the ramp and save it in a convenient place should it need to be reused to remove the cell roller.



Cell Rollers can be heavy and awkward to handle. Ensure that sufficient resources are available to safely move the product.

OPTIONAL ACCESSORY INSTALLATION

Connecting Alarm Contacts (ALRM302)

With the purchase of ALRM302, a set of terminals on the rear of the unit is provided to monitor temperature and humidity (controlled humidity option) alarms.

With the alarm contacts, the terminals provided allow for a NO (normally open) output, a NC (normally closed) and COM (common) connection. In the event of an alarm condition or power failure, the NO contact will close, and the NC contact will open. Once the alarm is cleared, the contacts return to their normal conditions. Insert the appropriate wire into the terminal and tighten down the screw terminal on top of the connector.

Terminal Connection	Unit off	Normal	Alarm
N/O to C	Closed	Open	Closed
N/C to C	Open	Close	Open

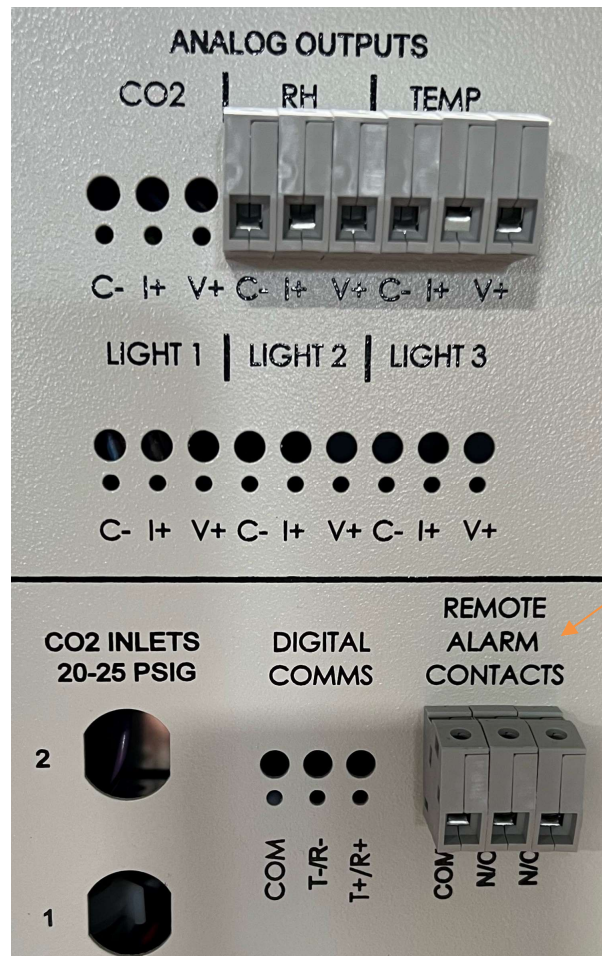

Alarm Contact Connections

Installing Carboy water system (BOTL301)

Incubators can be purchased with an optional 2.5 gallon carboy water system. The carboy system is preassembled and shipped inside the chamber. The four 1/4" bolts required to mount the carboy to the unit will be mounted in the left hand side of the chamber. Remove the carboy assembly from inside the chamber and attach it to the chamber using the 1/4" bolts.

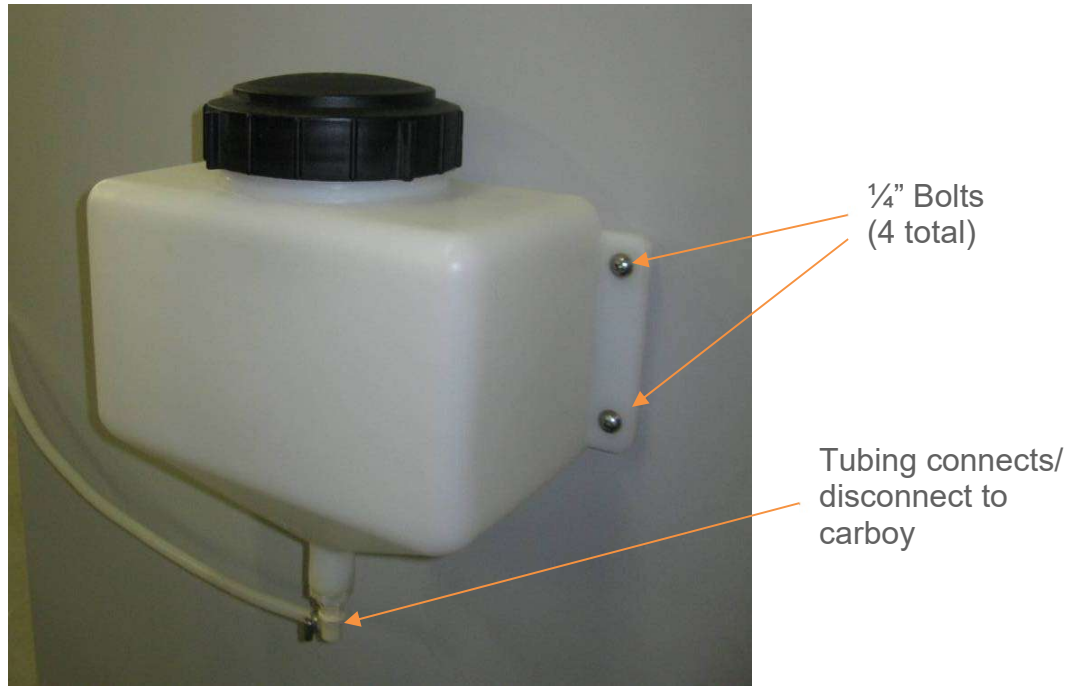

Attach the preassembled tubing provided with the carboy to the water inlet on the rear of the chamber.

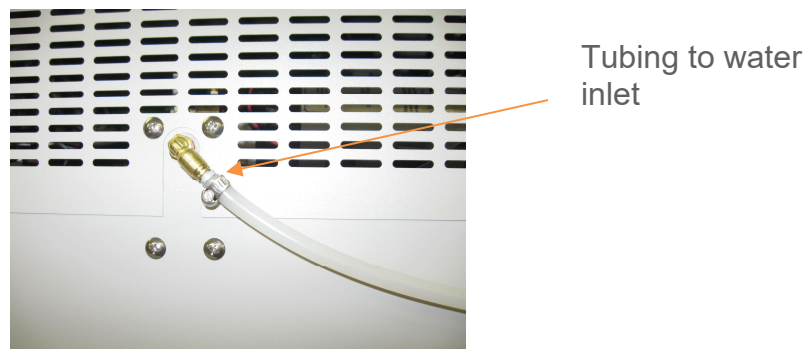

Fill the carboy with water as described in the "Using the Carboy Water System" section of the manual.

Connecting to Humidity System (HUMD304, HUMD307)



Use only distilled or deionized water with a resistivity between 50K Ω -CM and 1M Ω -CM and a pH of greater than 6.5. Using water outside this range will void your warranty.



Do not use water that contains chloramines. Chloramines can damage internal rubber gaskets resulting in leaks.

If these water sources are not available contact CARON customer service.

A water inlet fitting on the back of the unit and 1/4" black tubing are provided to connect the water supply to the incubator. Connect an appropriate water supply to the fitting. Incoming line pressure should be regulated to not exceed 80 psi.

CRSY102 or BOTL301 are accessories that can be used as water supplies. If a Condensate Recirculator CRSY102 water recycling system was purchased as a water supply, refer to its user's manual for proper installation.

Connecting Analog Outputs (OUTP302, OUTP303)

With the purchase of OUTP302 or OUTP303, the controls are equipped with analog outputs. OUTP302 provides 2 connections for monitoring temperature and humidity or CO₂. OUTP303 provides 3 connections for monitoring temperature, humidity and CO₂.

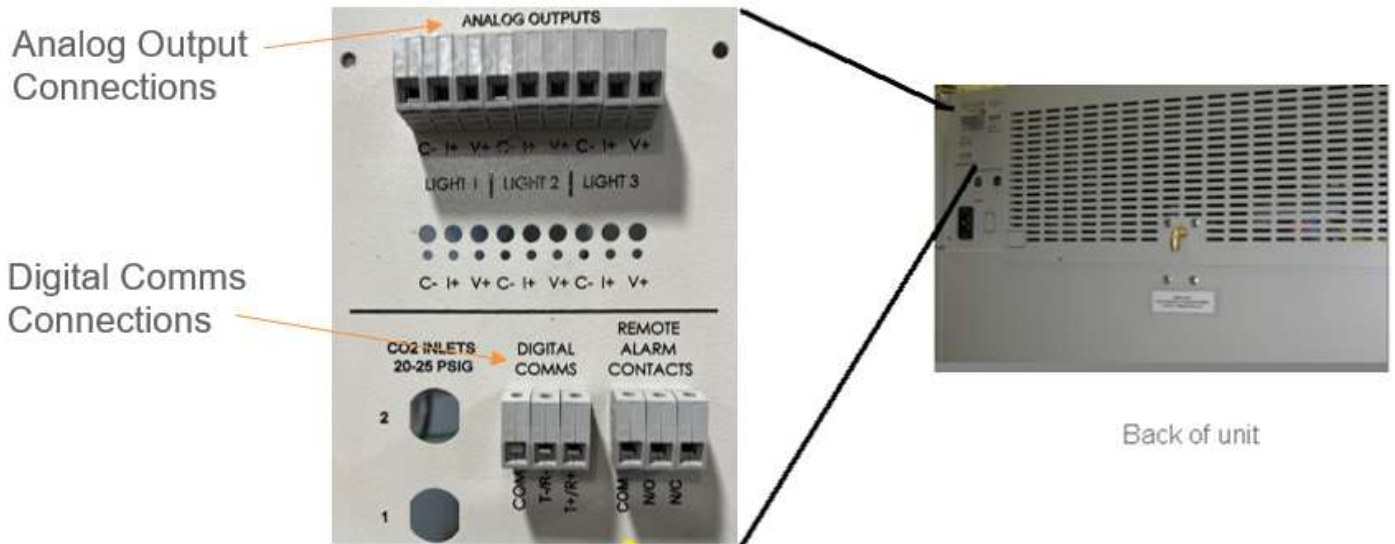

Analog outputs provide either a milliamp (4-20mA) or voltage (0-5V) signal output to represent each of the displayed temperature (and humidity) values. These options can be used for connection to in-house data acquisition, recorder, or alarm system. The temperature parameter (only) is adjustable in its scaling and is accessible at the Analog Output screen.

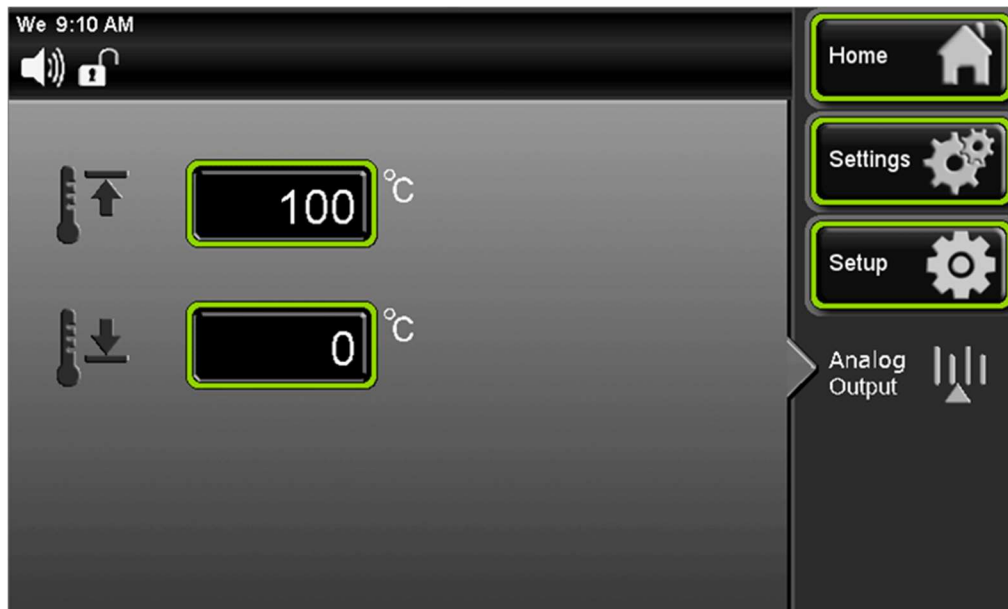

Parameter	Analog Output	Current	Corresponding Value
Temperature	0 – 5 V	4-20 mA	-50 – 100 °C (adjustable)
Humidity	0 – 5 V	4-20 mA	0 – 100 %rh
CO ₂	0 – 5 V	4-20 mA	0 – 20 %CO ₂

*Default range is -50C to +100C. Temperature scale low range is adjustable from -50C to 0C. Temperature scale high range is adjustable from 1C to 100C.

Connect shielded wires to the appropriate signal terminals: I(+) for current (mA) or V(+) for voltage (DC). For both current and voltage outputs, COM(-) is common terminal.

Installing Drain Water Pump (PUMP301)

Pump Outlet
to Sink or Floor
Drain



Pump Inlet
from Chamber
Drain

Reservoir with
Internal Level
Switch

In applications where a floor drain is not available and a CARON water recycling system CRSY102 is not being used, a drain pump can be purchased to pump any excess condensate from the chamber to a local sink or drain. The pump is located near the middle of the back of the chamber. Connect the supplied tubing from the pump to the sink / drain. The tubing may be run vertically into a ceiling but should not exceed 15 feet height. The pump is equipped with a small reservoir on the bottom of the pump with an internal level switch that will automatically turn the pump *ON* when it is full to drain the water out of the reservoir and into a floor or sink drain.

Install in a Wall - Trim Kit (WALL301, WALL302)

Wall trim kits are intended to simplify and enhance installation in situations where the incubator is embedded in a wall. In these situations, incubator sample content access is from inside a cleanroom while incubator service access is from outside the cleanroom. When used in conjunction with the corresponding WALL303/4/5/6 option, the incubator itself is closed off front-to-back.

The trim kits consist of trim frame, gasket material, bottom skirt, and caulking. When installed properly, the result is a double vapor barrier frame and covered floor skirt. Installation does not require mechanical fasteners. See separate WALL301/302 Installation Instructions for details.

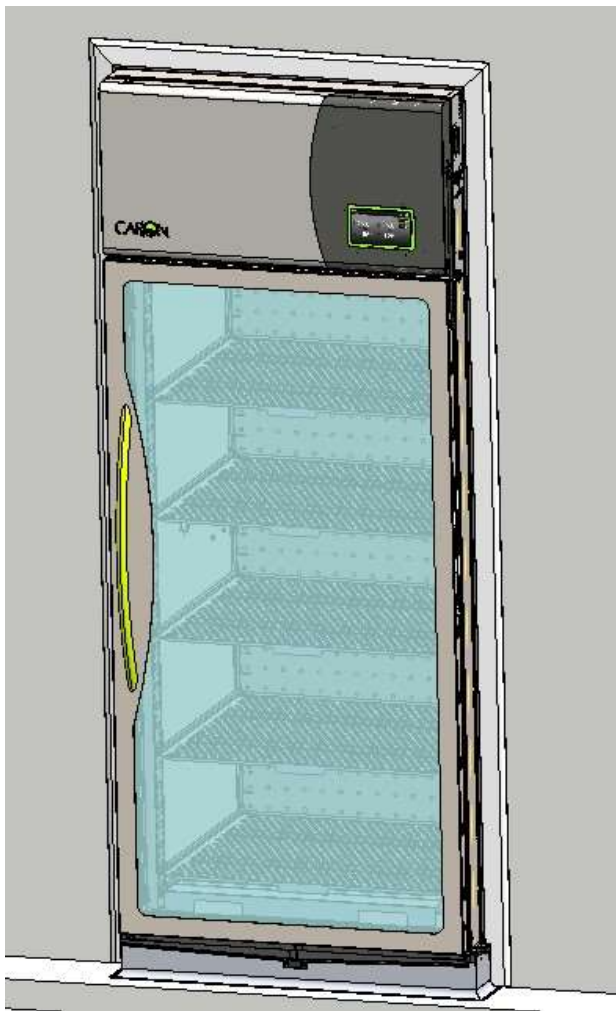

Model 7400-33-1
WALL302 Option
(Painted Incubator)

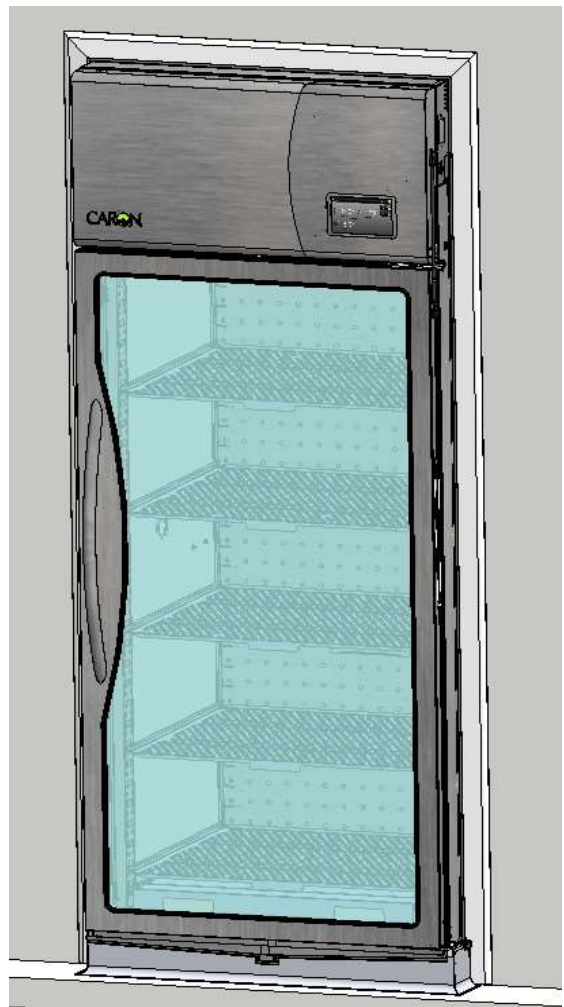

Model 7400-33-1
WALL302 Option
(Stainless Steel Incubator)

OPERATION

Before the incubator can be commissioned for use, make sure that the following steps have been completed:

- Chamber is properly installed and level.
- The appropriate utilities connected to the chamber.

With the above mentioned steps complete, the power switch located on the right side, near the top of the unit exterior, can be turned on.

Within a few minutes, the temperature and humidity will begin to approach setpoints. Here is an overview of the home screen.

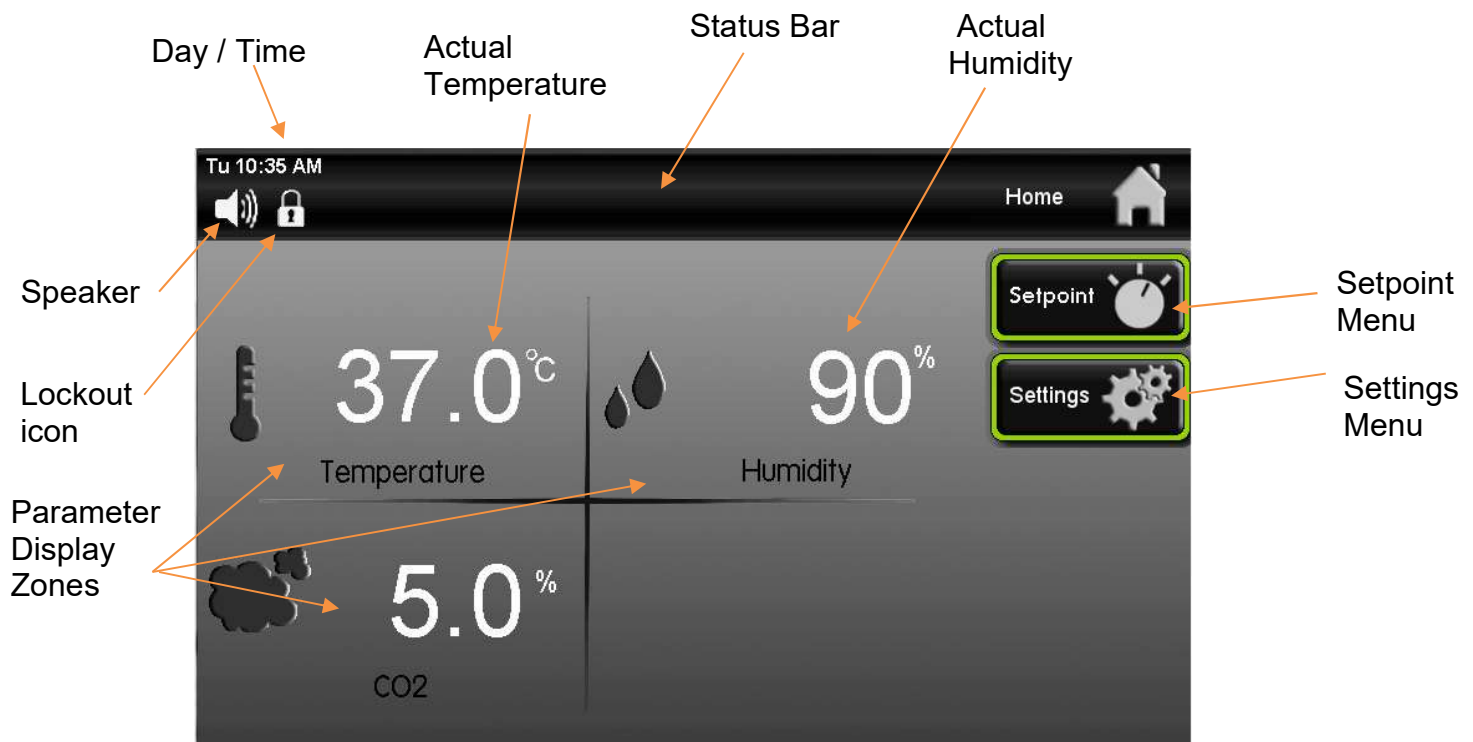

Main screen with HUMD304, HUMD307 option

Using the Keypad

This control system uses a numeric keypad to enter all parameter values. Similar to a calculator, this allows quick and precise entry of values. When any numeric value button is pressed, the keypad display will pop up over the current display.

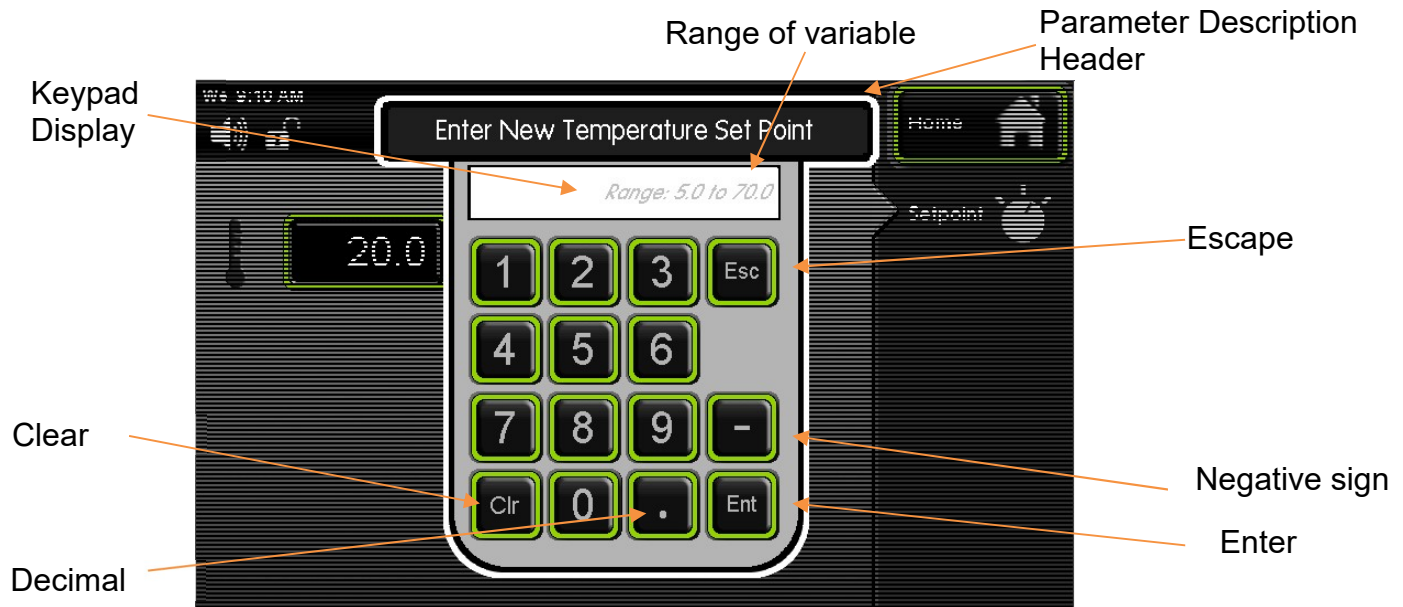

The Parameter Description Header tells what parameter is being changed. The Keypad Display shows allowable values of the parameter being changed (initially) and displays the entered value (when a button is pressed).

The Escape "Esc" button aborts the entry and returns to the previous screen without changing the value. The Clear "Clr" button erases the value that you have entered. After you have entered the value that you want, pressing the Enter "Ent" button and the new value will take effect. This also closes the keypad window. Other keypad buttons include a decimal point button and negative button.

If an invalid numeric button is pressed such that it would create an entry above the parameter's range, the entered number will not display. For example, if the temperature setpoint range is 5.0 to 70.0, pressing '8' followed by an '0', only the '8' will display.

If an invalid entry is made with an entry below the range (such as a '4' followed by the 'Ent' button), then the entry will clear and the range will be re-displayed.

Learning the Touchscreen

To save power and ensure long product life, the touchscreen display has a few features that can be changed to reduce screen brightness and initiate a Screen Saver mode.



High / Low button: high or low screen brightness, preset values.

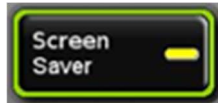

Screen Saver: By pressing the Screen Saver button “on” this will automatically enter screen saver mode after 15 minutes. At this time, the screen will be completely blank (ie. black). The illuminated Caron logo (see Equipment Overview section) shows that the unit is powered on and functioning. To wake-up the touchscreen, simply press anywhere on the touchscreen and the main screen will display. If the unit has an alarm condition, the touchscreen will not go into screen saver mode. If an alarm condition occurs while in screen saver mode, the display will automatically wake up and display the alarm.

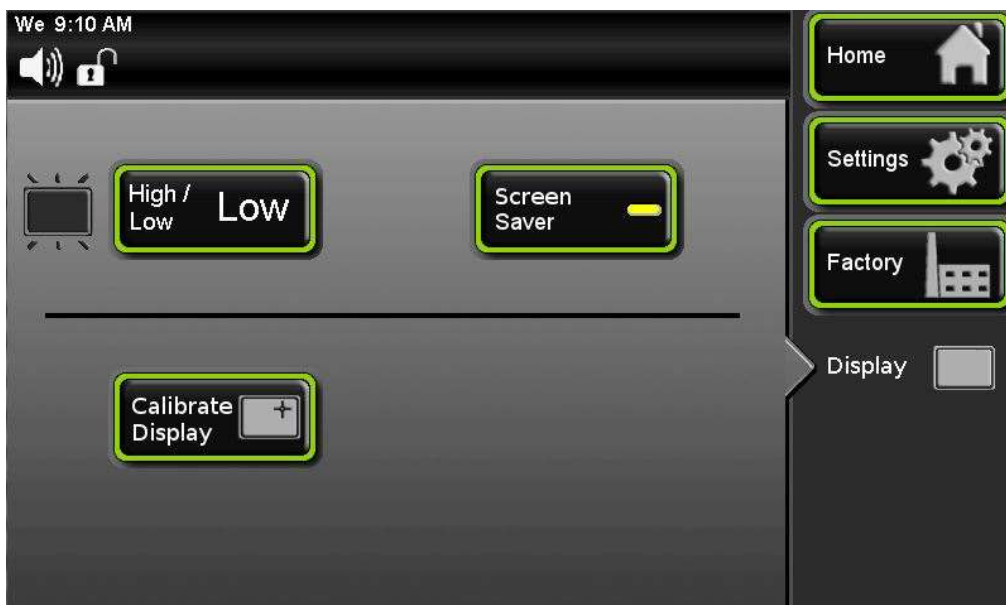

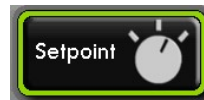
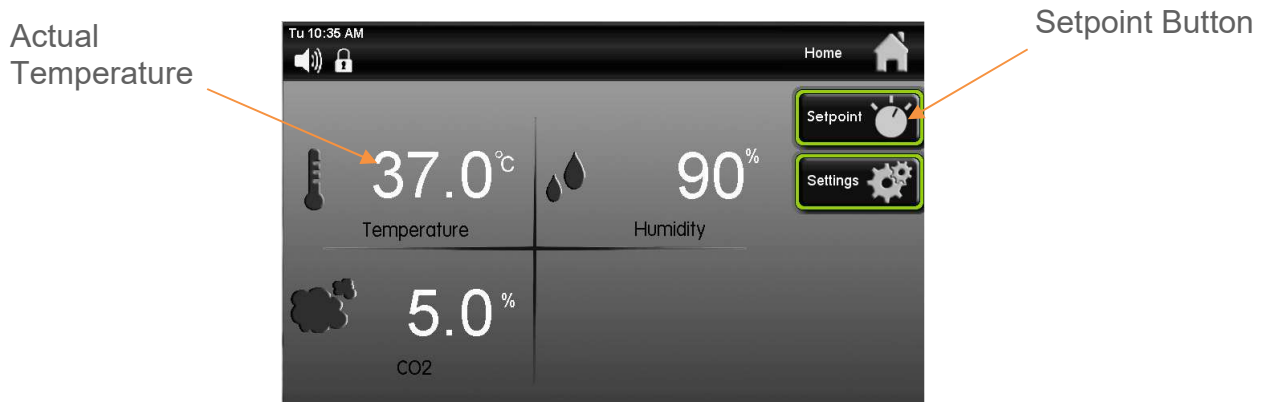

Changing the Temperature Setpoint

The steps below walk through an example of changing the temperature setpoint from 37.0 °C to 20.0 °C. This example shows optional humidity control. Here is the display of the home screen.



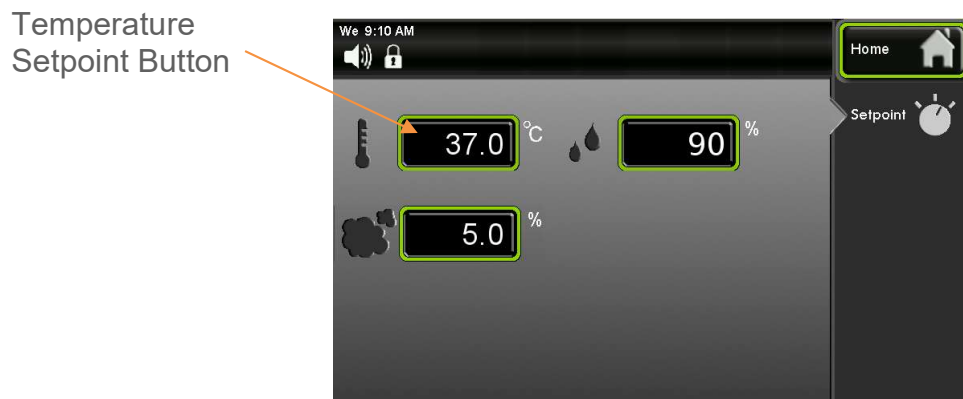



To set the temperature setpoint, press the  (Setpoint) button on the right side of the screen.

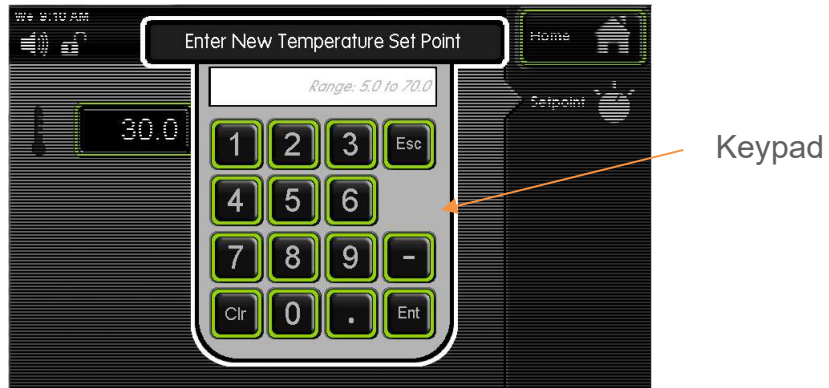

Once the Setpoint screen appears, press the  (Temperature Setpoint) button. (In this example the temperature setpoint initially has a value of '37.0'; this will vary with different initial setpoint values.)



A temperature setpoint window will appear. Enter the temperature setpoint by using the keypad. For a setpoint of 20, press  ('2'), then , followed by the  (Enter) key. Correct any mistakes with the  (Clear button) and reenter the value.

Once the Enter key has been pressed, the pop-up keypad disappears and the screen returns to the Setpoint display with the new value of 20.0 in the temperature setpoint button.

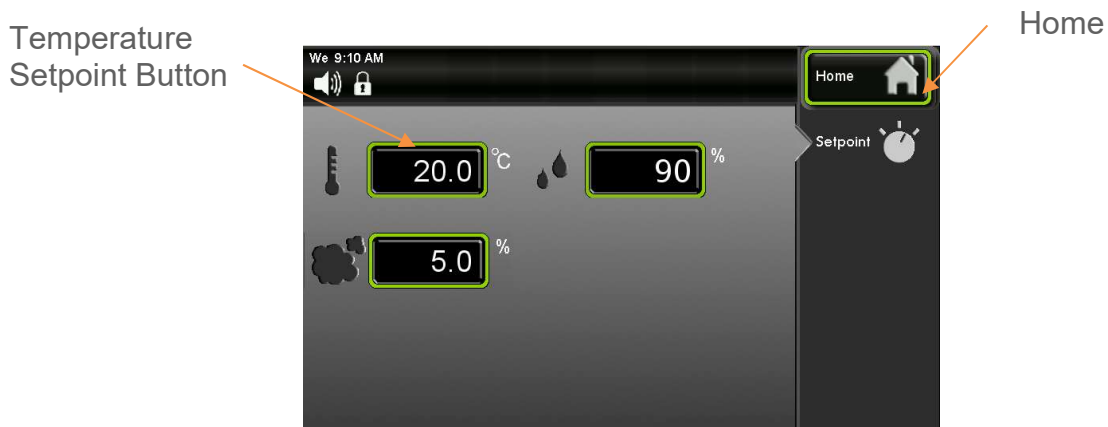

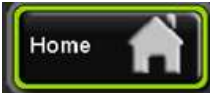
Press the  (Home) button to return to the main screen.

Changing the Humidity Setpoint (HUMD304, HUMD307 option)

Only controlled humidity will be displayed on the touchscreen, Evaporative pan humidification will not be displayed.

The steps below walk through an example of changing the humidity setpoint. Here is the display of the home screen.

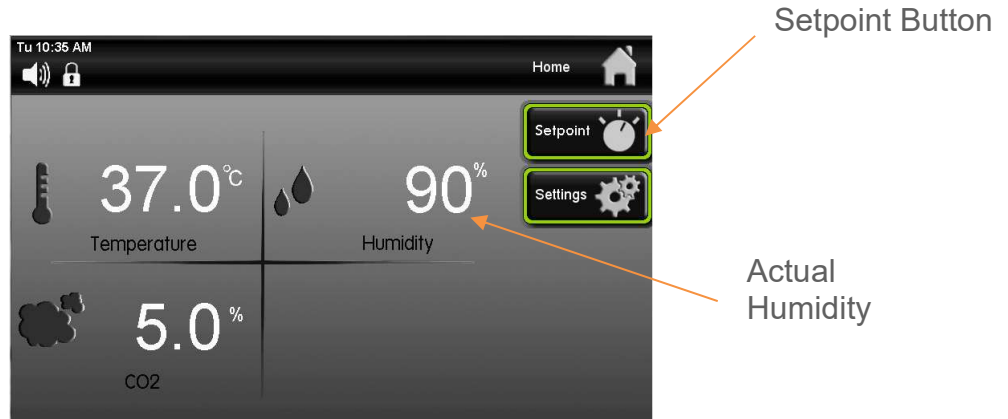

To set the humidity setpoint, press the  (Setpoint) button on the right side of the screen



Once the setpoint screen appears, press the  (Humidity Setpoint) button.

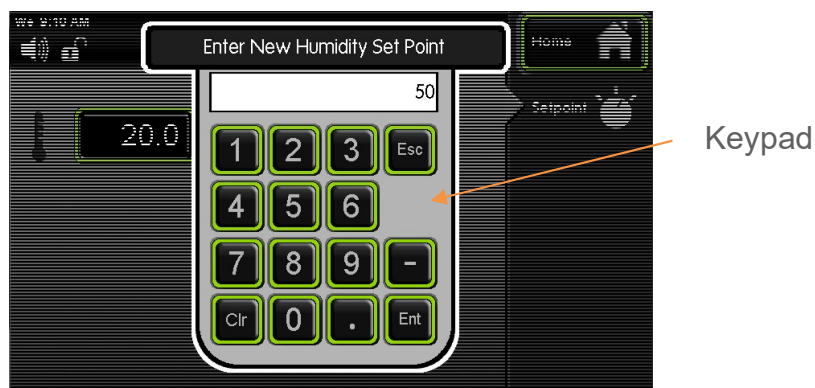



Enter the new humidity setpoint on the keypad as desired and press (Enter)



Home Button

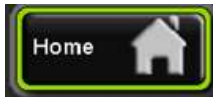

Press the (Home) button to return to the main screen.

Changing the CO₂ Setpoint

If an alternative CO₂ setpoint is required, the following steps can be taken:

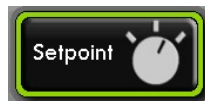
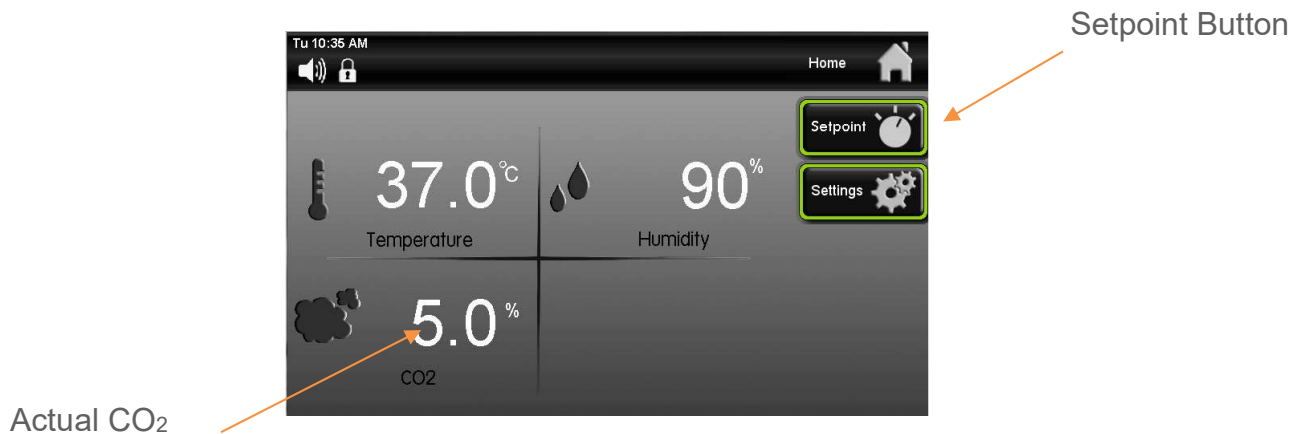

To set the CO₂ setpoint, press the  (Setpoint) button on the right side of the screen

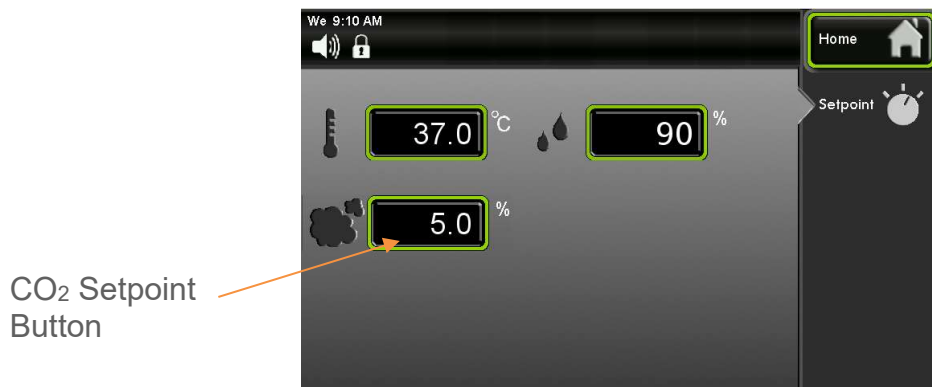

Once the setpoint screen appears, press the  (CO₂ Setpoint) button.



Enter the new CO₂ setpoint on the keypad as desired and press  (Enter) when complete.

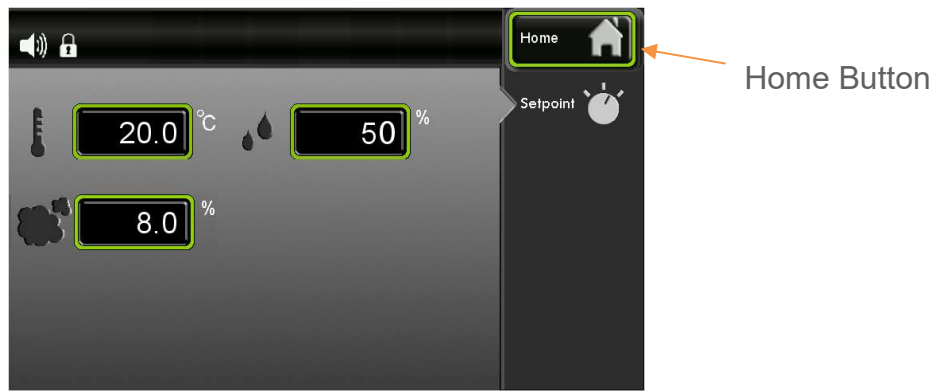

Press the  (Home) button to return to the main screen.

OPTIONAL ACCESSORY OPERATION

Using the Carboy Water System (BOTL301)

To fill the carboy while attached to the incubator, unscrew the cap. Fill carboy with distilled or deionized water (see Connecting the Water Supply section for details). The carboy holds 2.5 liters.

If the carboy must be removed in order to fill it up, first disconnect the tubing between the carboy and incubator by pressing the metal lever at the tubing connects / disconnects at the bottom of the carboy. Then unscrew the four mounting screws and remove the carboy. After re-attaching the carboy, connect the tubing by simply pressing the plastic fittings into each other.

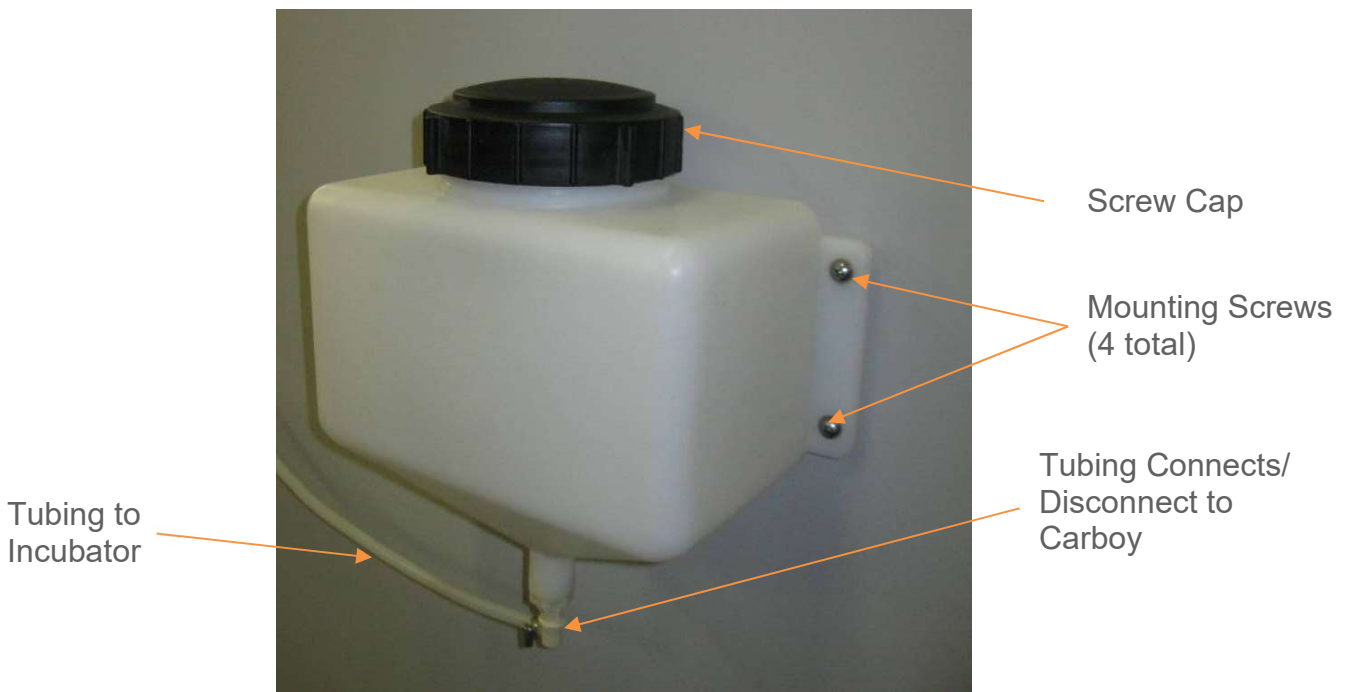

Cleanroom Wipedown (CLEN301, CLEN302, CLEN303, CLEN304)

Caron offers upgrades to the base incubator model for applications where moderate or aggressive chemicals are used to clean the incubator exterior. Bleach or chlorine containing solutions should never be used to clean the incubator. The customer is responsible to verify the chemicals used are compatible with the incubators. See Caron's Disinfectants Technical Bulletin for more details.

Incubators configured for moderate cleaning chemicals (CLEN301/302) have painted exteriors, but have type 304 stainless steel hardware, hinges, & coated door strips.

Incubators configured for aggressive cleaning chemicals (CLEN303/304) have type 316 stainless steel exteriors as well as type 316 stainless steel hardware, hinges, and coated door strips. Additionally, the touchscreen uses capacitive technology, providing additional ingress protection.

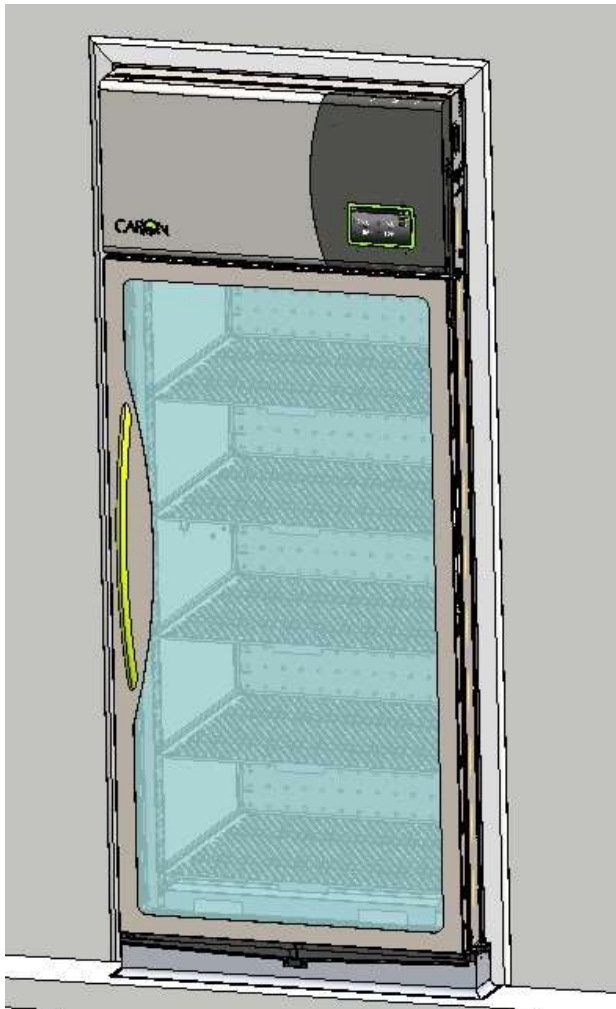

Model 7400-33-1
CLEN302 Option
(Shown in-wall)

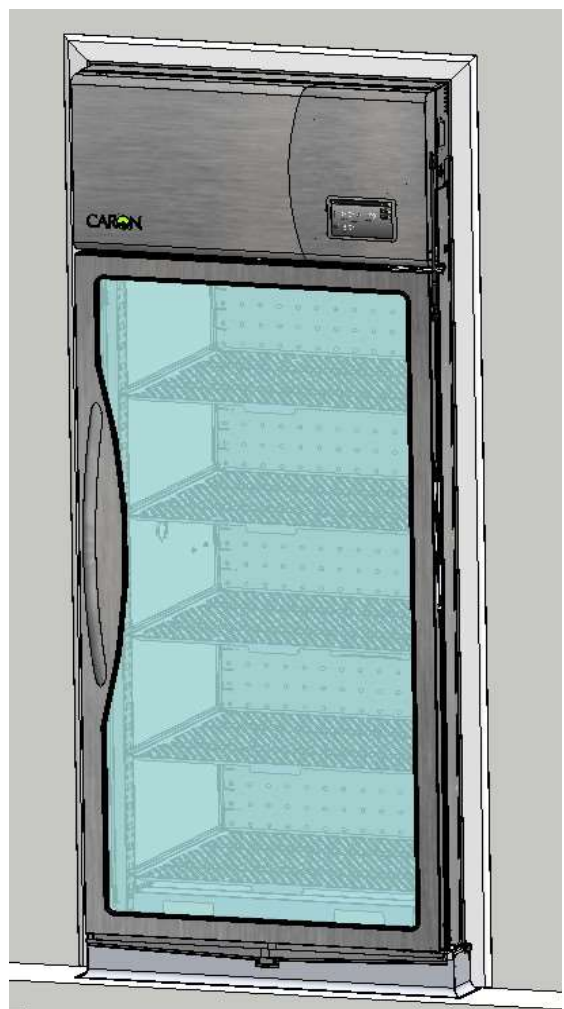

Model 7400-33-1
CLEN304 Option
(Shown in-wall)

Operation of the Data Logger (DLOG301)



The DLOG301 option provides the customer with a means of logging data electronically for viewing at a later date. Logged variables are Temperature, Humidity, CO₂ and Light Intensity (but only if the chamber is equipped with those features.) All data is time-stamped with year, month, day of the month, hour, minute, 24 hour time (ISO 8601 format). This data is stored internally in the chamber in non-volatile memory.

Note: The date and time are logged within the actual file name. The file's "Date modified" field is not maintained and therefore may not reflect the actual date and time the file was created.

Data is logged every 5 minutes (provided the chamber is on); more than 10 years of data can be stored in memory. If the internal memory fills up, new data overwrites the oldest data.



Continuous writing to the flash drive necessitates a high quality industrial grade device. Use only the flash drive provided by Caron (or equivalent: single level cell memory, wear leveling algorithms, error correcting code).



File name format is "DATE START YYYY-MM-DDTHH-MM_ .csv" (hours in 24 hour time)

When the chamber is on, the chamber's history data is being stored even when a flash drive is **not** inserted in the USB port. This data may be retrieved anytime using the provided USB flash drive.

Here are the methods for retrieving data:

Continuous logging of data

Insert the flash drive into the chamber's USB port. When first inserted, it creates a .csv file called 'DATA START' with the current date and time in the file name. At 5 min intervals, the chamber's process values are appended to the file. (The file will get as large as the flash drive, permitting several years of uninterrupted data storage.)

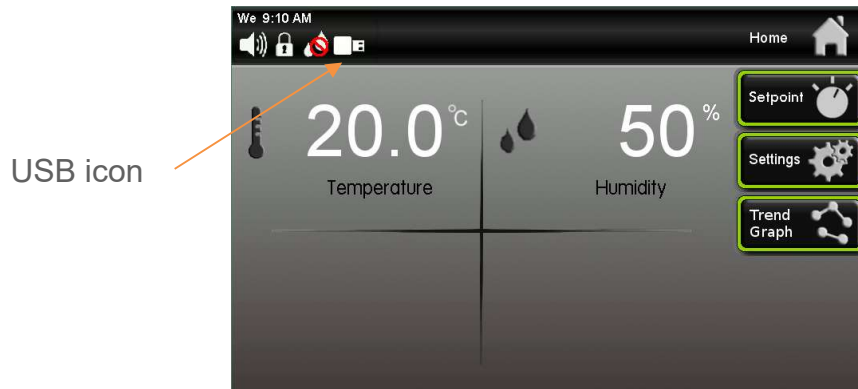

USB icon appears in in Status bar indicating that data is being written to flash drive.

To retrieve the data press the 'Eject' button, then insert the flash drive into a computer to upload the data.

Upon re-insertion of the flash drive, a new .csv file is created, even if the old file is still present. File name nomenclature is "DATE START YYYY-MM-DDTHH-MM_ .csv".

History Retrieval

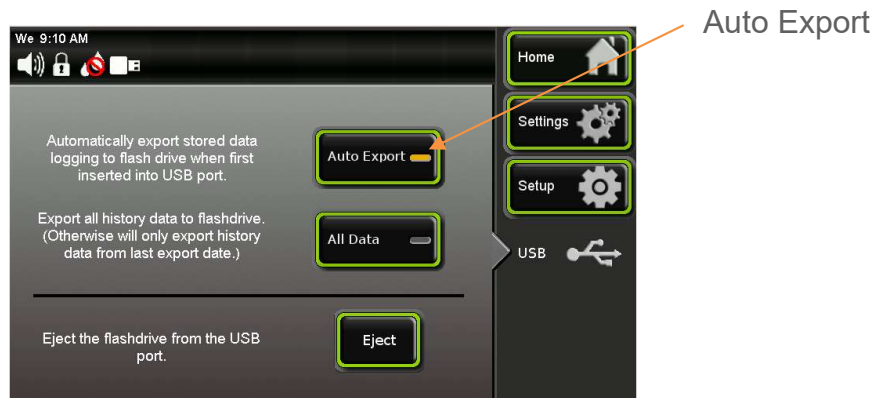

Select the 'Auto Export' feature on the USB menu screen. Insert the flash drive into the chamber's USB port. A new .csv file is automatically created on the flash drive with all the stored history data. The file name nomenclature is "DATE END YYYY-MM-DDTHH-MM_ .csv".

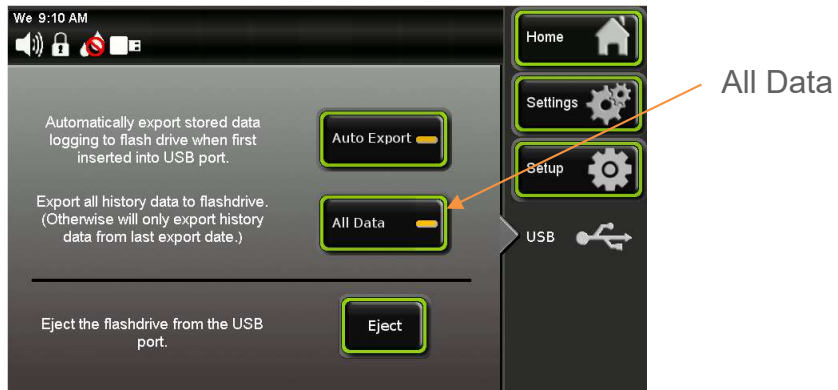

There is also an 'All Data' feature to indicate if the upload should include all data (since the unit has been used) or just the history data since a flash drive was last inserted. An 'Info' button will appear in the status bar warning the user not to remove the flash drive while the data is being uploaded. The length of time to upload the file will depend on the file size. When the 'Info' button disappears from the status bar, press the 'Eject' button to safely remove the flash drive. Now the data can be uploaded to a computer for viewing.

When using the Continuous Logging of Data method, nothing on the touchscreen has to be setup. However using the History Retrieval method will require going into the USB screen to select either the 'Auto Export' or 'All Data' buttons before inserting flash drive into USB port.

To select the 'Auto Export' and 'All Data' buttons.

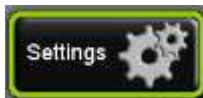

Press the (Settings) button.



Setup Button

Press the  (Setup) button.

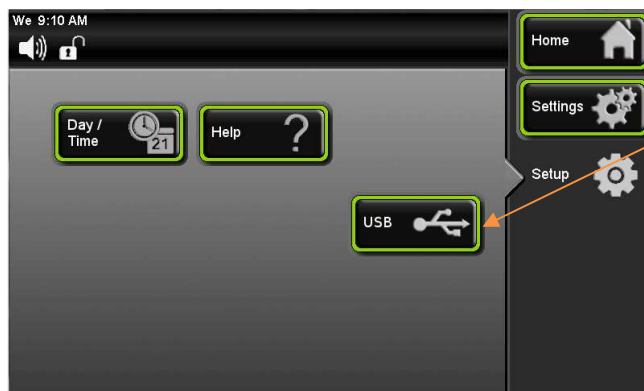

USB Button

Press the  (USB) button.



When the 'Auto Export'  button is selected this will retrieve the data starting at the point of the last download, and continuing to the present time.



When the 'Auto Export' button is selected this will retrieve the data starting at the point of the last download, and continuing to the present time.

USB flash drive icon



Info button

Eject button

When flash drive is inserted into the USB port a 'USB flash drive' icon and flashing 'Info' button appears in the status bar indicating that the data is being downloaded to

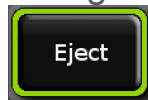

the flash drive. Once 'Info' icon stops flashing select the 'Eject' button.

Wait until the USB icon disappears to safely remove the flash drive from the USB port.

Note: Press the Eject button before removing the flash drive from the chamber, otherwise there could be the risk of corrupt data.

Here is a graphic to illustrate how the data retrieval works.

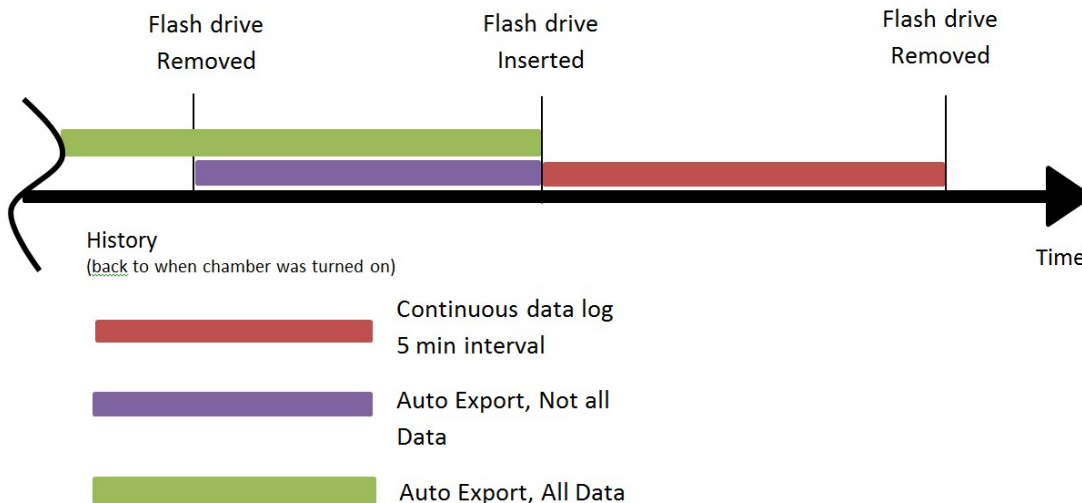

Extended Temperature Range (EXTD302)

The extended temperature range is a factory installed option for model 7400. This extends the temperature range down to 10°C. Simply enter a lower temperature value when entering the temperature setpoint.

Built In Gas Guard System (GASG302)

An optional built in gas guard system is available to allow two tanks of CO₂ to be connected to an incubator requiring approximately 20-25 PSIG of gas pressure. The unit is designed to automatically switch from the primary tank to the secondary tank when low gas pressure of approximately 10 psig is detected on the primary tank. This allows for a continuous supply of CO₂ to an incubator after the primary tank is empty. In addition, the user is notified of a tank empty scenario via an audible and visual alarm.



The CO₂ gas supply should be 99.5% pure and should not contain a siphon tube. Gas pressure to the unit must be regulated to less than 30 PSIG. Failure to do so could cause tubing to burst.

The CO₂ gas supplies must be equipped with two stage regulators to ensure that the incoming gas to the unit is regulated to appropriate levels. The high pressure stage should have a 0-2000 PSIG range, and the low pressure gauge should adjust from 0-30 PSIG. When connecting the gas supplies, adjust each tank output to 20-25 PSIG. If the appropriate regulators are not available, contact CARON customer service to purchase them.

Once the cylinder regulators are installed and adjusted on each tank, connect the outlet of the regulator on Tank 1 to the hose barb fitting labeled Tank 1 on the back of the unit. Repeat the process for Tank 2. Turn on the regulated gas supplies and check the connections closely for leaks.

To access the internal Gas Guard,

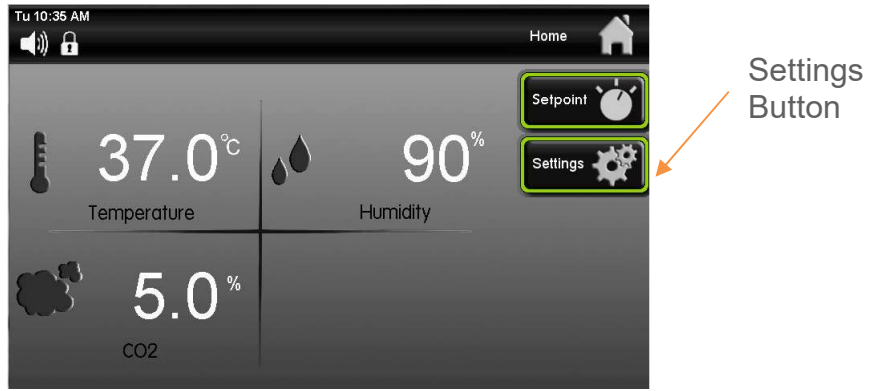

Press the  (Settings) button.



Press the  (Gas Guard) button.

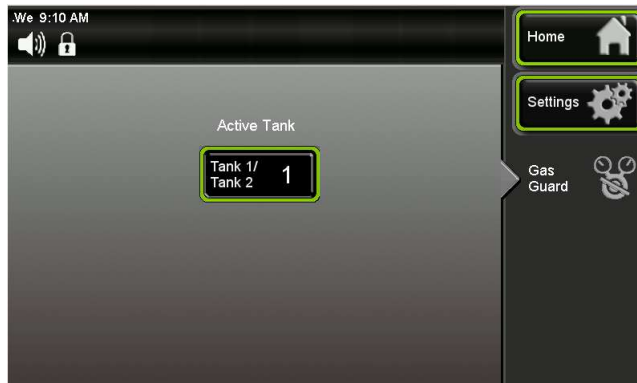

Press the  (Tank 1 / Tank 2) button, will manually switch the tanks.

The factory default “master tank” is Tank 1. When the appropriate gas pressure is supplied to both tanks, the master tank will always be used as the gas source. The unit will swap from the master tank to the alternative tank whenever a low gas pressure condition is detected.

Ultraviolet Germicidal Lamp (LGHT602)



Before removing access panel(s), disconnect electrical power.



Avoid exposure to direct or reflected germicidal ultraviolet rays. Germicidal ultraviolet rays are harmful to the eyes and skin.

Replacing UV Light (optional accessory)

1. Turn off chamber and unplug power cord.
2. Remove the incubator top access panel. The housing is located in the back of the incubator.
3. Unclip green wire with ground clip from UV light housing.



UV Light Housing Cap

Green Wire with Ground Clip

4. Pull UV light housing cap from UV light housing. Connected UV lamp will come out with it.





See separate ultraviolet light owner's manual for specific warnings and instructions.



Follow local regulations for disposing lamps.

5. Discard used UV lamp
6. Insert new UV lamp into lamp connector socket.
7. Install UV light housing cap (with attached new UV lamp) into UV light housing.
8. Re-attach ground clip.



Ground clip must be securely attached to UV light housing to reduce risk of electrical shock.

9. Install left access panel.
10. Plug power cord in and turn chamber on.

Interior Electrical Outlet (OUTL331 - OUTL340)

An optional interior electrical outlet is available to supply power to small interior appliances such as shakers or stirrers. It is not intended to power high current draw devices. Each outlet will handle up to 1.0 Amp. Incubators with a single interior outlet will handle 1.0 amps total. Incubators with three outlets will provide 3.0 amps total. All outlets are resettable GFI protected. Other outlet configurations can be purchased.



OUTL331/OUTL336 US outlet is 115V/60Hz
(Standard on model 7401, 60Hz incubators)



OUTL332/OUTL337 European “Schuko” outlet
(Standard on model 7401, 50Hz incubators)



OUTL333/OUTL338 UK, British outlet



OUTL334/OUTL339 Australia outlet



OUTL335/OUTL340 Brazil outlet

Interior Electrical Outlet (OUTL321 thru OUTL330)

An optional interior electrical outlet is available to supply power to small interior appliances such as shakers or stirrers. It is not intended to power high current draw devices. Each outlet will handle up to 1.0 Amp if 115V or 0.5A if 230V. Incubators with three outlets will hold 3.0 amps total if 115V or 1.5A total if 230V. All outlets are resettable GFI protected.

This incubator is equipped with an internal hydrocarbon (HC) sensor. The status of the HC sensor is indicated by the green/yellow/red indicator lights near the outlets.

LED Color	Status Description	Outlet
Green	Sensor working and safe HC level	Energized*
Yellow	Sensor is initializing	Not energized
Red	Risky HC level detected	Not energized

*If outlet is not energized, either the GFCI or fuse may have tripped.



R290 REFRIGERANT UNITS



DANGER – Flammable Refrigerant Used. Risk of fire or explosion.

- No equipment that uses an open flame should be placed inside the refrigerator.
- Do not use instrumentation or equipment that incorporates potential ignition sources, e.g. open contact switching, brushed DC and AC motors, etc.



OUTL321/326 US outlet 115V, 60Hz



OUTL322/327 European “Schuko” outlet 230V, 50Hz



OUTL323/328 UK, British outlet is 230V, 50Hz



OUTL324/329 Australia outlet is 230V, 50Hz



OUTL325/330 Brazil outlet is 230V, 60Hz

Operation of Temp or Temp/Rh 6" Recorders (RCDR316/RCDR317)

Built in 6" ink pen temperature and or humidity recorders can be purchased with CARON incubators. The recorders are shipped installed on the outer door of the incubator from the factory and require no installation.



Changing the chart paper:

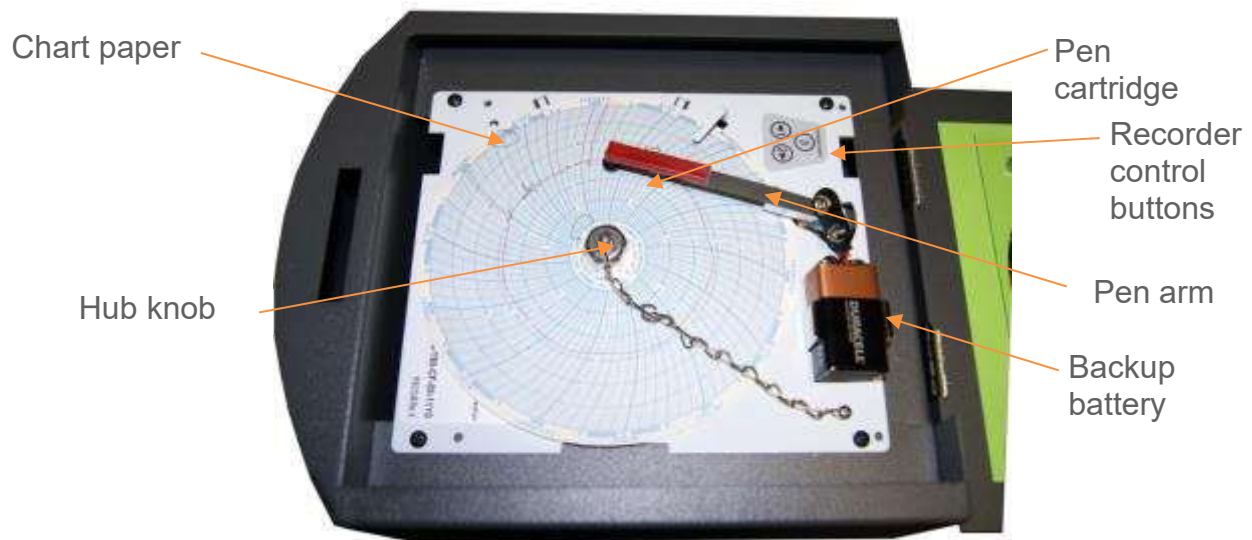

Press and hold the “change chart” button on the recorder (#3) for approximately one second until the pen begins to move to the left of the chart and then release the button. Wait until the pen has completely moved off of the chart. To remove the chart paper, unscrew (counter-clockwise) the chart “hub” knob at the center of the chart.

Remove the old chart paper and position the new one so that the correct line coincides with the time line groove on the chart plate.

Re-attach the chart “hub” knob and fasten securely against the chart. Press and hold the “change chart” button (#3) again for approximately one second until the pen begins to move back onto the chart and then release the button. Check to make sure that the pen is marking on the chart paper. If it is not, then carefully adjust the pen arm to establish contact with the paper.

Chart recorder marking system:

This type of pen consists of a self contained ink reservoir with a porous plastic stylus which is snapped around the outer edge of the metal pen arm. A pen cap is provided to extend the life of the ink pen during shipping or when the recording unit is not in service. To remove the pen cap, gently lift the pen arm away from the chart paper. Remove the black plastic pen cap to expose the fiber tip of the ink pen and gently place the pen back onto the chart paper. Do not let the pen arm “snap” back onto the chart paper. This will flatten the fiber tip of the pen and will no longer give you a fine line marking on the chart paper. Place the pen cap in a safe place for future use. If the stylus does not touch the chart, adjustment can be made by slightly bending the metal pen arm in the center towards the chart paper. Do not use more pressure than is necessary to create a fine line marking on the chart paper. As the pen ink supply runs out, the pen color will become lighter. This indicates that the pen should be replaced.

Replacement of the Pen:

Recorders that are equipped with fiber tipped cartridge pens will have a cartridge that is color coded “red” to designate pen number one and an optional cartridge that is color coded “blue” to designate pen number two. The pen cartridge is securely fastened to the metal pen arm using a special “U” clip tab. For ease of replacement, it is suggested that the two screws that hold the pen arm be loosened and the pen cartridge and metal pen arm be removed as an assembly. Unsnap the plastic “U” clip tab of the pen cartridge from the metal pen arm, remove and discard the old pen cartridge. Replace the new cartridge by opening the hinge and snapping it securely around the metal pen arm. Refer to the image below:

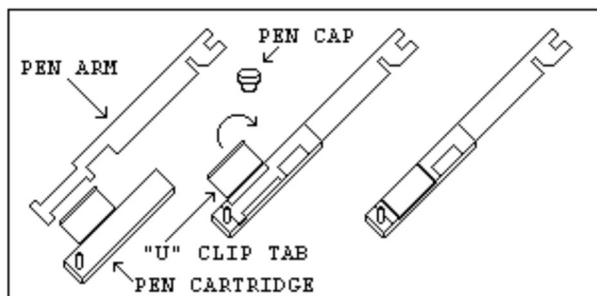

Pen Arm Calibration:

To check and/or adjust the recording pen(s) calibration to the outer most temperature graduation of the chart, press and hold the "change chart" button (#3) until the pen begins to move off of the chart. Once the pen(s) has moved off of the chart, again press and hold the "change chart" button (#3) until the pen begins to move back onto the chart. The pen should briefly stop at the outer most temperature graduation of the chart before continuing onto the chart to begin recording. If the pen does not stop exactly at this location on the chart, it can be adjusted or "calibrated" by using the left (#1) or right (#2) arrow buttons.

When the pen moves back onto the chart and briefly stops, you will have approximately five seconds in which to adjust the pen's position using the left and right arrow buttons of Figure 3.

On multiple pen recorders, each pen will move (one at-a-time) onto the chart briefly stopping at the outer most temperature graduation of the chart at which time the pen's position can be adjusted by using the left (#1) or right (#2) arrow buttons. When the time to adjust the position of the first pen has expired, the second pen will move onto the chart briefly stopping at the outer most temperature graduation of the chart at which time the second pen's position may be adjusted.

Each time the chart paper or fiber tip pen cartridge is changed, you should make sure that each pen stops at the outer most temperature graduation of the chart paper. Otherwise, this pen offset will cause the unit to record an incorrect temperature on the chart.

Recorder Calibration:

If a calibration adjustment is required for a single pen recorder, use the left (#1) and right (#2) arrow push buttons on the recorder to calibrate (or move) the pen's position on the chart to correspond to the temperature of the solution. The arrow buttons must be held for approximately five seconds before the pen will begin to move.

For two pen recorders, you must first select the pen that you wish to calibrate. This is done by pressing the left (#1) arrow button to select the red pen or the right (#2) arrow button to select the blue pen. The arrow button must be held down until the green LED light goes out. After the green LED light goes out, follow the instructions in step #3 above.

Battery Backup:

The green LED light remains a constant green color indicating that both the battery and the main power to the unit are good. Refer to Figure 5 for the location of the green LED indicating light. If the AC power were to fail or the battery becomes weak, then the green LED light will begin "flashing" indicating that either you have lost the main power to the unit or it is time to replace the battery. Having a 9 volt DC battery back-up in place, will allow the recorder to continue to function normally for approximately 24 hours in the event of a power failure.

Built In Temp or Temp/Rh 10" Thermal Recorders (RCDR318 / RCDR319)

Built in 10" thermal pen recorders can be purchased with CARON incubators. The recorders are shipped installed on the outer door of the incubator from the factory and require no further installation. Unlike ink pen recorders, the thermal recorders draw their own chart and control lines.

The 10" recorders have been setup at the factory in the following configuration: 7 Day / 24 Hour / Temperature 0-100°C / Humidity 0-100% (for dual input recorders). If this is not the ideal configuration for an application, the recorder may be reconfigured using the following process:

Configuring the recorder:

In order to configure the recorder, you will need to enter the set-up mode of the recorder. To enter the set-up mode of the recorder, press and hold the Change Chart button (#3) until the thermal pen arm begins to move off scale and then release the button.

Note: The green LED light will flash fast while the thermal pen arm is moving off scale.

Wait until the thermal pen arm has moved completely off scale and stops (the green LED light will stop flashing and will be steady On). Unscrew (counter clockwise) the chart "hub" knob at the center of the chart and remove the recording chart paper. Gently lift the thermal pen arm just enough to be able to slide the paper out from beneath it. Remove the recording chart paper and place the Setup Chart onto the recorder. This chart contains the configuration categories of the recorder (Probe Input, Inner Chart Temperature, Outer Chart Temperature, Temperature Scale, Chart Rotation Speed, Input Filtering, Optional Relay Contacts and Date/Time for internal clock).

Next, press and hold either button #1 or #2 until the green LED light goes out and release the button. If this step is successfully completed, the pen arm will move to the outermost graduation ring of the Setup Chart. Use the Left (#1) or Right (#2) arrow buttons to adjust the center of the thermal pen to be on this outermost graduation ring.

Position the Setup Chart so that the tip of the thermal pen is in the center of the Start circle. Tighten the chart hub knob to secure the chart in place. Next, press and release the Change Chart button to begin. The chart will rotate to the first category (Input #1). Use the Left and Right arrow buttons to move the thermal pen arm to the desired option of each category. Press and release the Change Chart button to accept the selection and advance to the next category. You must press and release the Change Chart button when you have finished configuring the last category in order to save all of the changes that have been made to the recorder's configuration. The thermal pen arm

will move off of the chart allowing you to place the recording chart paper onto the recorder. Press and release the Change Chart button to begin recording.

Changing the Chart Paper:

Press and hold the Change Chart button (#3) for approximately one (1) second until the pen begins to move off scale and then release the button.

Note: The green LED light will flash fast while the thermal pen arm is moving off scale.

Wait until the thermal pen arm has moved completely off scale and stops (the green LED light will stop flashing and will be steady On). To remove the chart paper, unscrew (counter clockwise) the chart "hub" knob at the center of the chart. Gently lift the thermal pen arm just enough to be able to slide the paper out from beneath it. Remove the old recording chart paper and position a new one.

Re-attach the chart "hub" knob and screw securely (by hand) against the chart. Press and hold the Change Chart button (#3) again for approximately one (1) second and the thermal pen arm will move back onto the chart and begin recording.

Green Light LED Status:

The green LED light (located just below the three button membrane switch) is used to show the recorder's status:

- 1.) LED on steady (not flashing) and input(s) recording within chart range, indicates unit is recording normally.
- 2.) LED on steady (not flashing) and pen arm above outermost graduation and not moving, indicates recorder is in Change Chart mode. Press and release Change Chart button to return to normal recording mode.
- 3.) LED flashing rapidly and one or both inputs recording at outermost or innermost graduation indicates a sensor break. Check or replace sensor(s). If sensor(s) are ok, make sure process temperature is within configured range of recorder.
- 4.) LED flashing slowly (.8 seconds ON / .8 seconds OFF) indicates recorder is in Set-Up mode. Refer to section CONFIGURING THE RECORDER.
- 5.) LED is Off indicates that there is no power to the recorder. Check A/C power to the recorder.

Recorder Calibration:

If calibration is required for single input recorders, use the Left (#1) and Right (#2) arrow buttons on the recorder to calibrate the temperature being recorded on the chart to correspond to the temperature of the solution. The arrow buttons must be held for approximately eight (8) seconds before the pen begins to move.

If calibration is required for dual input recorders, you must first select the input that you wish to calibrate. This is done by pressing and holding the Left (#1) arrow button to select Input #1 or the Right (#2) arrow button to select Input #2. The arrow button must be held down until the green LED light turns off, after which follow the instructions in single input instructions above.

Maximizing Pen Life:

In order to maximize the amount of life expected out of the thermal pen tip, follow these simple rules:

- 1) Never let the thermal pen tip ride on the chart plate when the chart paper is not present. This will damage the protective coating of the heating element.
- 2) Never use chart paper that is creased or that has been folded.
- 3) Periodically clean the thermal pen tip with a cotton swap dipped in alcohol. Clean more often when operating the recorder in a dusty environment.
- 4) Always keep the door closed while the unit is recording.
- 5) Never lift the pen arm more than is necessary to remove and replace the chart paper. Excessive lifting may cause a decrease in the pen tip pressure and cause light printing.

Operation of H2O2 Sterilization cycle (STER305)

If the incubator is equipped with a STER305, then it is able to use the STER301 sterilization module (not included). STER305 includes an internal wiring connection for the sterilization module as well as door safety interlock. See separate STER301 User's Manual for details. Abide by all warnings.

Operation of the Door Latch with Optional Lock (LTCH301 / LTCH302)

The door latch is shipped installed on the incubator from the factory and requires no installation. LTCH301 is the latch assembly only, and LTCH302 is the latch assembly with an integral lock.



LTCH301



LTCH302

To operate the latch, grasp the pull handle and squeeze it toward the main door handle. The latch will disengage. Continue pulling on the handle to open the door. Closing the door fully will automatically re-engage the latch as long as the latch pull handle is not squeezed. On LTCH302, inserting and turning the key when the door is closed will activate the lock, prohibiting the pull handle from being squeezed enough to disengage the latch.



Latch cannot be disengaged from inside the incubator

CALIBRATION

The temperature and humidity systems can all be calibrated as necessary. CARON recommends an annual calibration check of each system. Before making a calibration adjustment, allow the cabinet to stabilize a minimum of 12 hours from a power off condition. If the unit has been in operation, allow a minimum of 3 hours of stable operation at all setpoints.

If you do not have the appropriate reference instruments to perform calibration, contact CARON's service department for on-site calibration at www.caronproducts.com Caron also provides validation services which ensure that the unit is functioning properly according to IQ, OQ and PQ protocols which satisfy FDA guidelines for qualification verification of equipment.



Be sure that all reference instruments are calibrated to an appropriate standard.

The Calibration Screen

To get to the calibration screen from the home page:

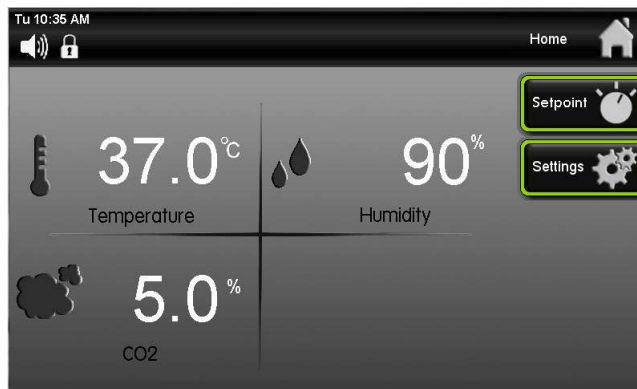

Settings
Button

Main screen with HUMD304, HUMD307 option

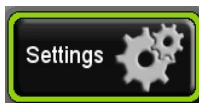

Press the  (Settings) button.

Calibrate Button

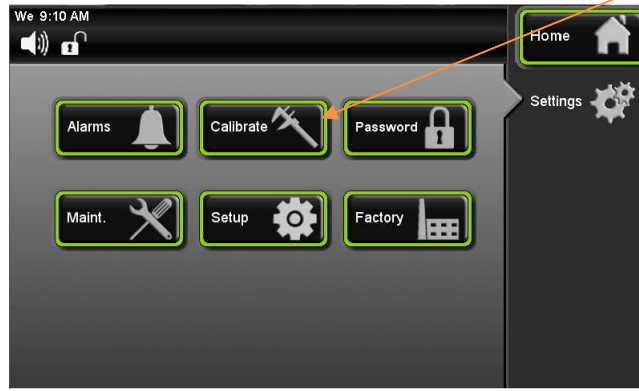

Press the  (Calibrate) button.

Temperature
Calibrate Button

CO₂ Calibrate
Button



Humidity
Calibrate Button

If optional features such as CO₂ are purchased, a calibration button will also appear for those options.

Calibrating Temperature

If temperature calibration is needed, the following steps can be taken:

Locate the reference instrument's temperature sensor in close proximity to the cabinet's geometric center. Be sure that the stabilization times described earlier have been satisfied prior to performing calibration.

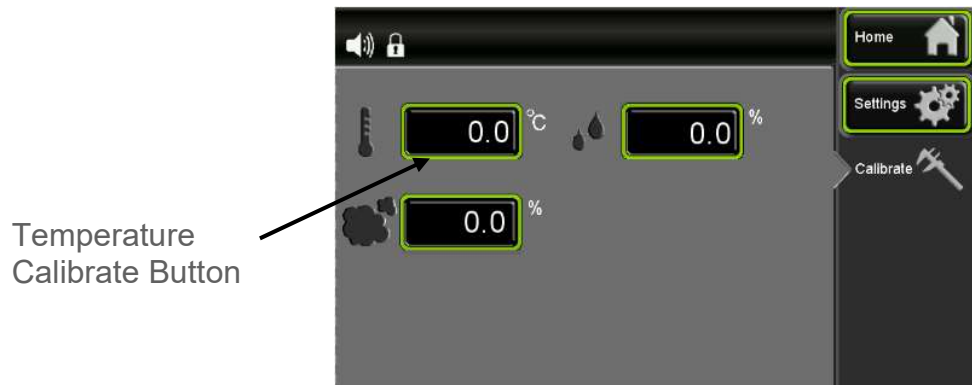

At the calibrate screen, press the  (Temperature Calibrate) button.

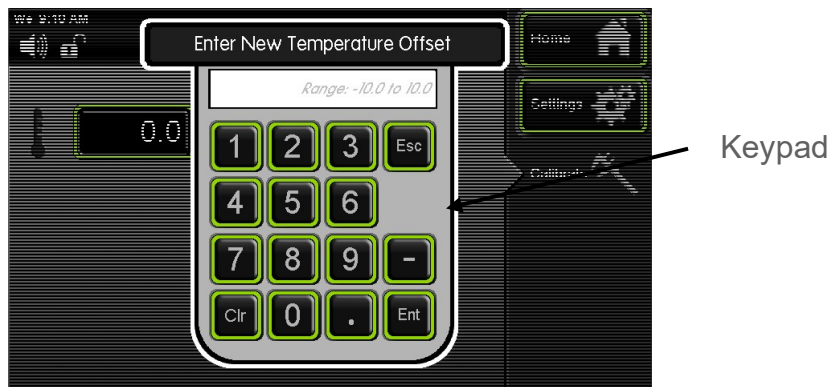

Enter the temperature offset by using the keypad and pressing  (Enter) when complete.

A positive value will move the temperature 'up' and a negative value 'down'. Press the 'home' button and verify the proper temperature is displayed.

Temperature calibration (example)

If the chamber temperature display reads 40.0°C and the calibrated independent sensor shows 40.3°C, set the temperature offset value to 0.3°C. If the calibrated independent sensor shows 39.6°C, then the entered offset should be negative. In this example the required offset to temperature would be -0.4°C.

Calibrating Humidity

Only Controlled Humidity will be displayed on the touchscreen and can be calibrated.

If humidity calibration is needed, the following steps can be taken:

Locate the reference instrument's humidity sensor in close proximity to the cabinet's geometric center. Be sure that the stabilization times described earlier have been satisfied prior to performing this calibration.

A positive value will move the humidity 'up' and a negative value 'down'. Press the 'home' button and verify the proper humidity is displayed.

Humidity calibration (example)

Only Controlled Humidity will be displayed on the touchscreen and can be calibrated

If the chamber humidity display reads 80% and the calibrated independent sensor shows 83%, set the humidity offset value to 3.0%. If the calibrated independent sensor shows 74%, then the entered offset should be negative. In this example the required offset to humidity would be -6.0%.

Calibrating CO₂

If CO₂ calibration is needed, the following steps can be taken:

Locate the reference instrument's CO₂ sensor in close proximity to the cabinet's geometric center. Be sure that the stabilization times described earlier have been satisfied prior to performing this calibration.

A positive value will move the humidity 'up' and a negative value 'down'. Press the 'home' button and verify the proper humidity is displayed.

Calibrating Optional Chart Recorders

For calibrating the optional front and side mounted chart recorders, refer to section (Optional Accessory Operation)

ALARMS

Alarm System Overview

The incubator control system is equipped with an alarm system that constantly monitors temperature, CO₂ and humidity (on controlled humidified models) to ensure the user is notified if the cabinet goes into an alarm condition. Notification occurs via an alarm pop-up window and a buzzer. Each alarm condition has been factory programmed to minimize nuisance alarms while maximizing warning time. There is a 2 hour time delay after start-up and setpoint changes. To avoid nuisance alarms after a routine door opening, an alarm condition must be present for 15 minutes* (45 minutes for humidity) before the operator is alerted. If the optional remote alarm contacts are present, in an alarm condition, the dry contacts will change state.

*Alarm delays are adjustable, see “Changing Alarm Setpoints and Delay” for details.

The following alarm messages may be displayed:

- Chamber temperature is higher than setpoint temperature
- Chamber temperature is lower than setpoint temperature
- Chamber CO₂ is higher than setpoint CO₂
- Chamber CO₂ is lower than setpoint CO₂
- Door Open
- Temperature sensor error

In the event an alarm occurs, the alarm indicator will appear on the status bar and an audible alarm pop-up window will automatically appear.

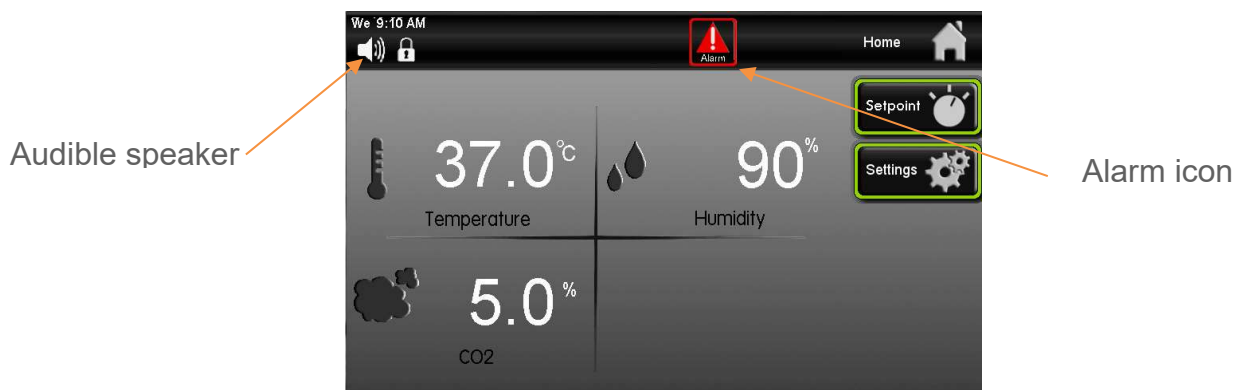

The flashing  (Alarm) icon will appear on the status bar.

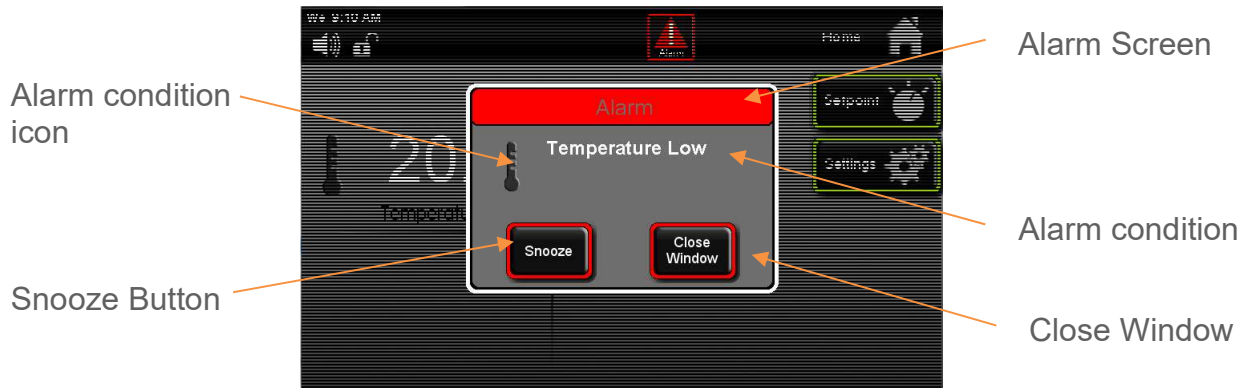

Audible Alarm Snooze Function:

When in an alarm condition, the Audible Alarm can be temporarily silenced to avoid being a nuisance to those nearby. The Audible Alarm will repeat after 1 hour has passed, if the condition has not been corrected. (The audible alarm will not sound if the alarm is muted, see Audible Alarm Mute)

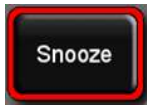

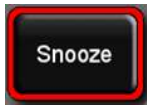
Press the  (Snooze) button, the audible alarm is silenced for a period of 60 minutes.

When the alarm condition is corrected the alarm indicator and the audible alarm will automatically turn off (unless there is another alarm condition).



To check what the alarm condition is, press the  (Alarm) button on the status bar.



and the alarm window will be displayed. If the  (Snooze) button has already been pushed and 60 minutes have not passed the Snooze button will be “greyed” out.



If you press the  (Close Window) button, the Alarm Window will close, but the alarm will still be present as a flashing alarm icon on the status bar for the remainder of the 1 hour of time. It will not reset the 1 hour alarm countdown time if the alarm condition is viewed on the pop up window.

After the 1 hour time has passed for an alarm condition, the counter will reset itself to 1 hour and repeat the countdown process again until the alarm has been resolved.

Audible Alarm Mute:

By factory default, when an alarm condition is present, the speaker will sound. This speaker can be muted in an 'on/off' fashion eliminating all audible sounds. (Muting the speaker will silence it until manually 'un-muted'. This is different than 'snooze' in the fact that snooze can only be enabled when an alarm condition is present and only lasts for 1 hour.) When the speaker is muted, the alarm icon continues to flash and the remote alarm contacts (optional) remain in the 'alarm' state.

To mute the audible alarm:

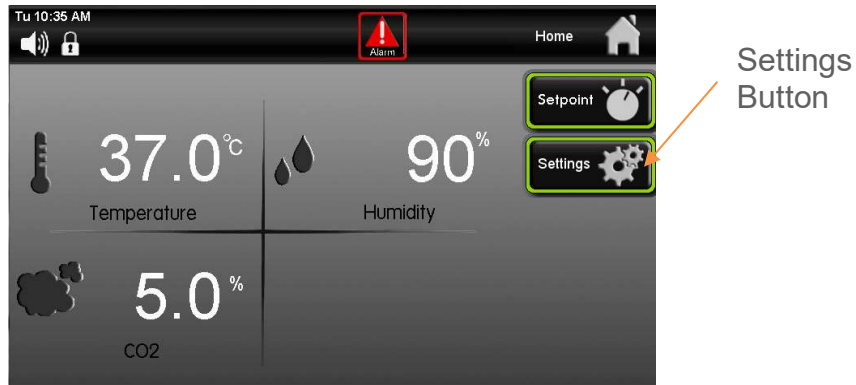



Press the  (Settings) button.



Press the  (Speaker Mute) button.



The Speaker Mute button toggles to the “on” position , and the speaker icon changes to  “Speaker Muted” icon.

Changing Alarm Setpoints and Delay

All alarm setpoints were pre-set at the factory to minimize nuisance alarms that could be created as a result of door openings. Alarm setpoints can be changed based on individual user requirements. Alarm values are deviations from the setpoint and are not actual setpoint values.

To change the alarm setpoints and delay:

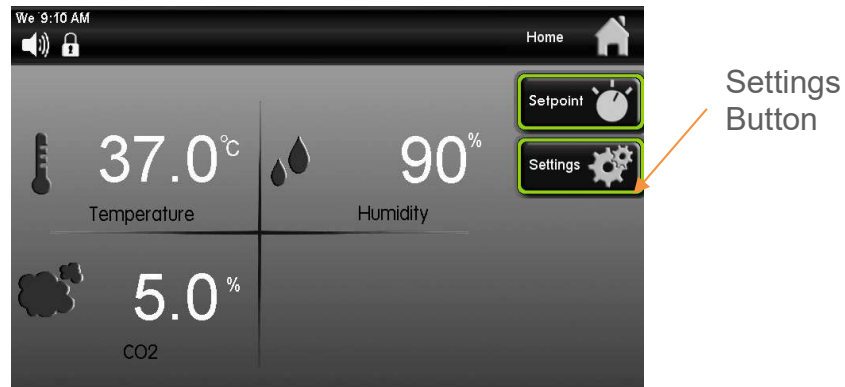

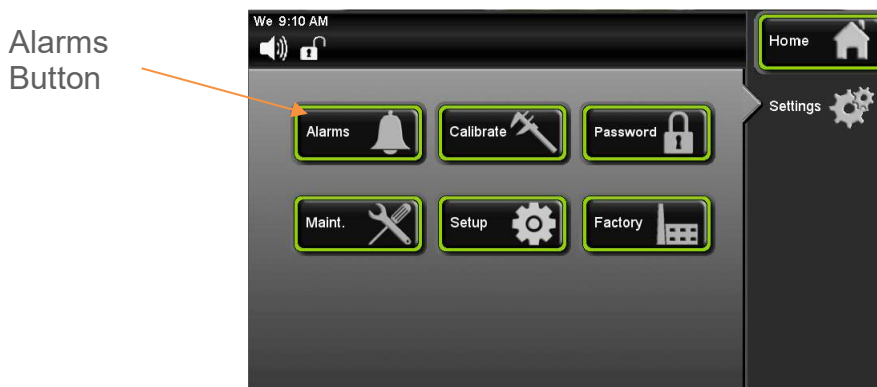

Press the  (Settings) button.

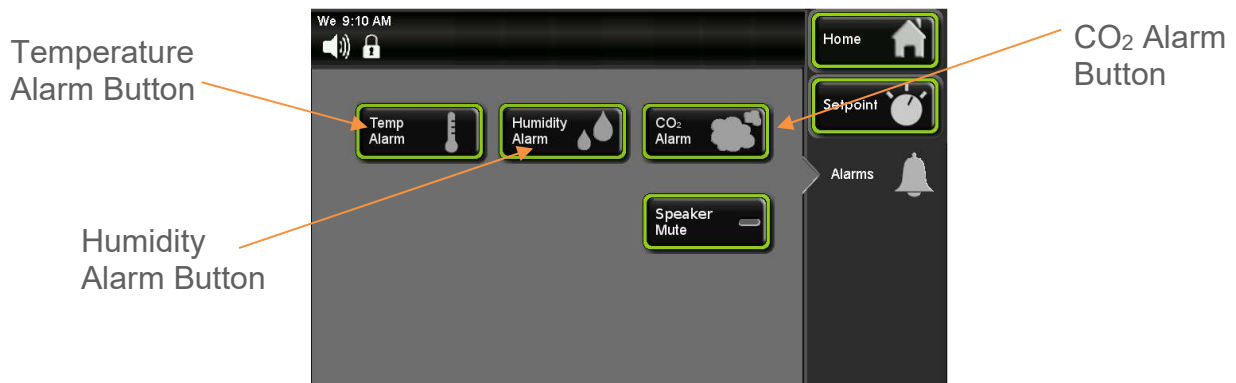

Press the  (Alarms) button.

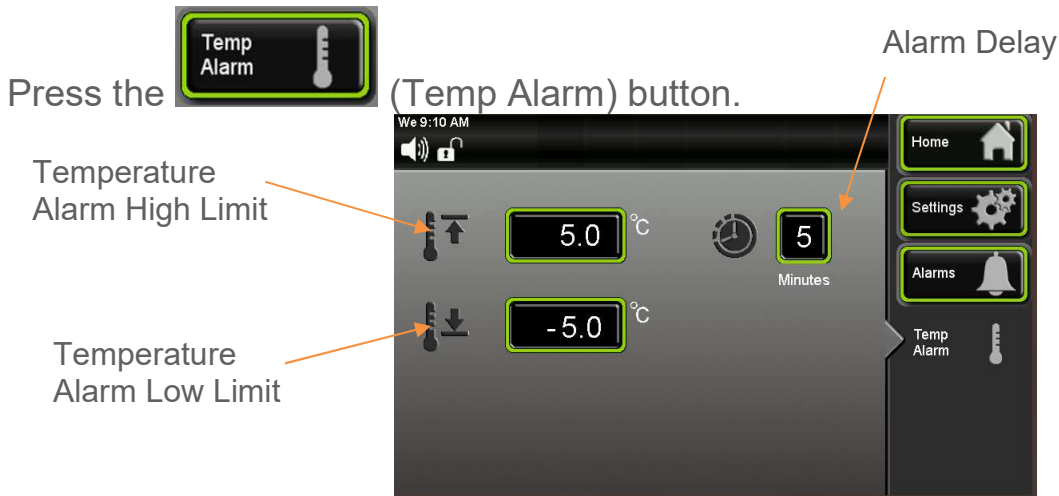



Once the alarm screen appears, press the  (Temp High Limit) button.



Keypad screen will appear. Enter the High Temp Alarm value; press  (Enter) when complete.

To change the CO₂ Alarm, press the  (Alarms) button on the navigation

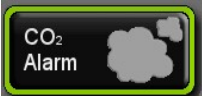
menu to go back to the Alarms screen. Press the  (CO₂ Alarm) and

 (Humidity Alarm, *Controlled Humidity only*) buttons and repeat the same steps for CO₂ and humidity.



To change the alarm delay, press the alarm delay button and enter the delay in minutes.

ALERTS

Alert System Overview

The chamber control system is equipped with an Alert system that constantly monitors features of the chamber and notify the user if the cabinet needs any type of service to ensure good running performance of the chamber. Alerts draw user attention to regular maintenance needs, and minimize the risk of a future alarm condition.

When an Alert notification occurs, contact www.caronproducts.com with the serial number of the chamber to order preventative maintenance kit(s).

Some of the Alert features are: Check the Atomizers (humidified units only), Replace the Air Filter, and Check Equipment Calibration is Due.

Notification occurs via an Alert icon on the status bar. When the Alert icon is pressed, a pop up window will display the alert condition(s). Each alert condition parameter is factory pre-set, no adjustment is necessary.

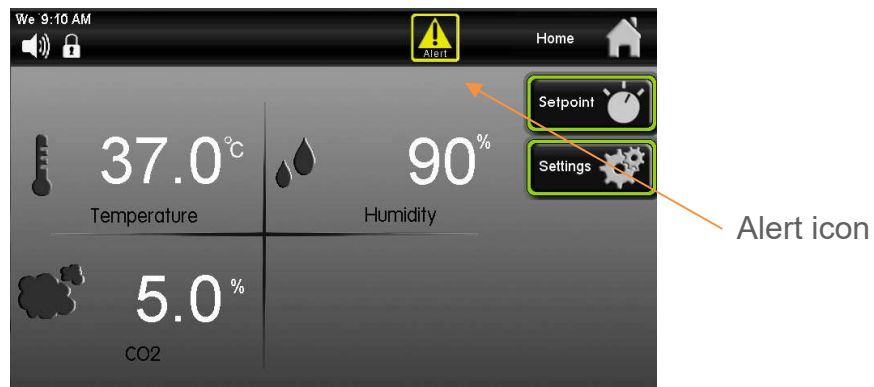

Press the  (Alert icon).

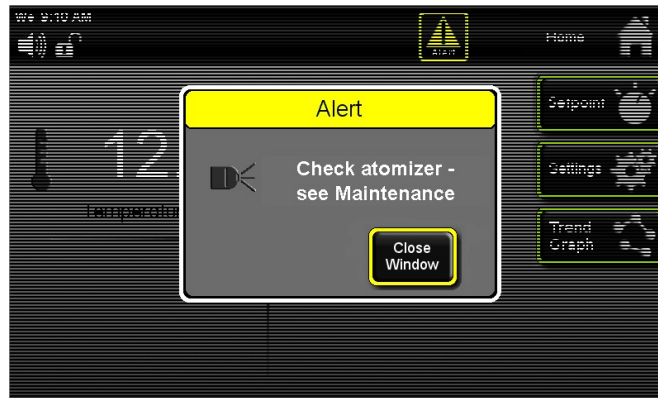

The Alert pop up window will appear displaying the alert message.



Press (Close Window) button to make the pop up window disappear.

Resetting Maintenance Alerts

Maintenance Menu Screen lets users check to see how much time is remaining on an item that may need routine service or calibration. This is very convenient to inform the user that a particular item will need to have service performed soon. After service has been completed, the item needs reset and the alert will disappear.

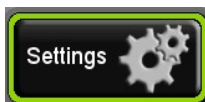

Press the (Settings) button.

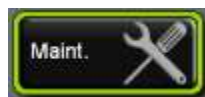
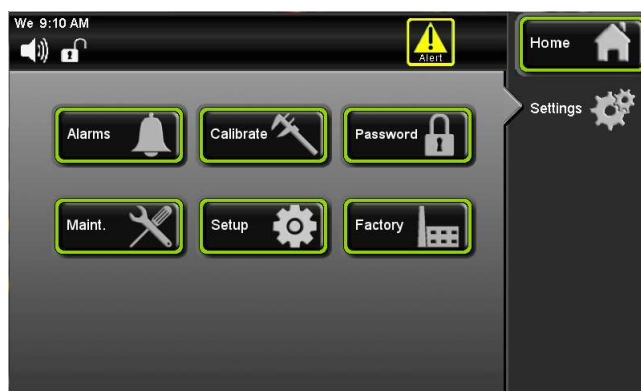

Once the Settings screen appears, press the (Maintenance) button.



Once a Maintenance item is displayed on the Alert screen, it will continue to be present as an icon in the Status Bar until the Maintenance item is corrected and the (Reset) button is pressed resetting the replacement time to “new” status.

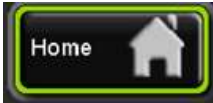

Press the  (Home) button to return to the main screen.

INFO

Info System Overview

The incubator control system is equipped with an Information system that constantly monitors the incubator and to notify the user when an automatic condition is occurring. This applies to conditions such as Decon Cycle or others that cannot be switched on and off by the user but is controlled automatically by the software of the control system. This notification cannot be disabled, it only lets the user know the incubator's current status.

Notification occurs via an Info pop-up icon on the status bar. When the Info icon is pressed a pop up window will display the Info condition(s).

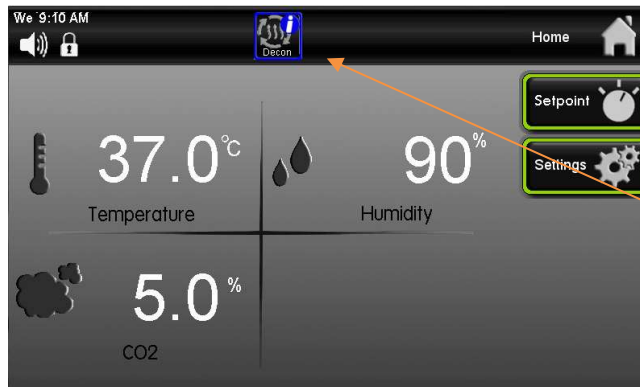

Info Button



The  (Info) icon will appear on the status bar.

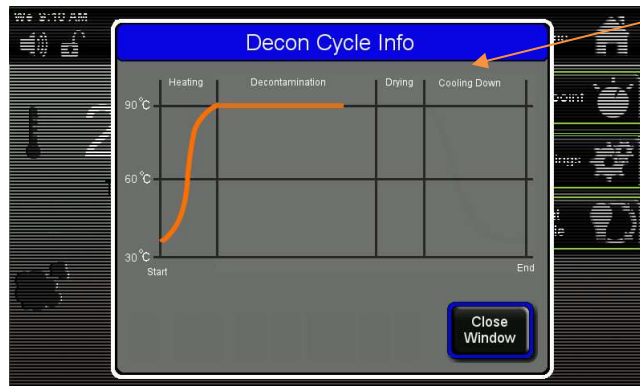

Info Screen



Press the  (Close Window) button to return to the main screen.

ADVANCED FEATURES

Setting the Time & Day

The chamber has an internal real-time clock that keeps track of the day and time. It is set at the factory to Eastern Standard Time and may need to be adjusted for your time zone. To keep the clock accurate, it will need to be adjusted manually for daylight savings time changes. To set the day & time:

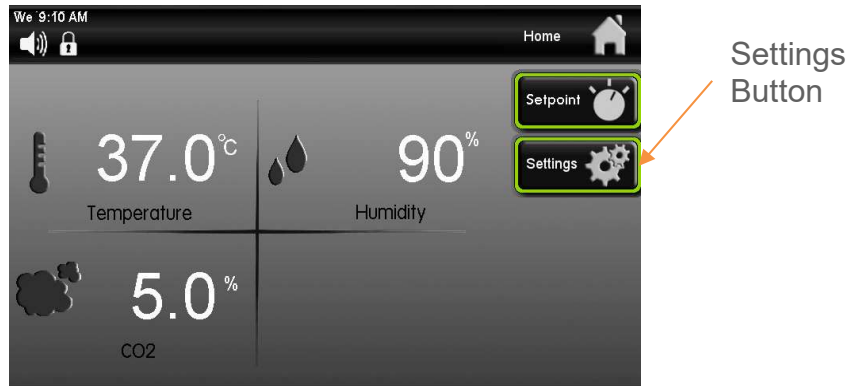

Press the  (Settings) button.

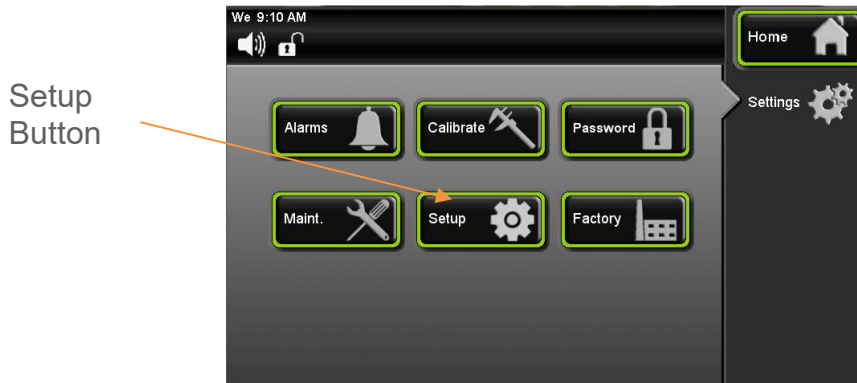

Press the  (Setup) button.

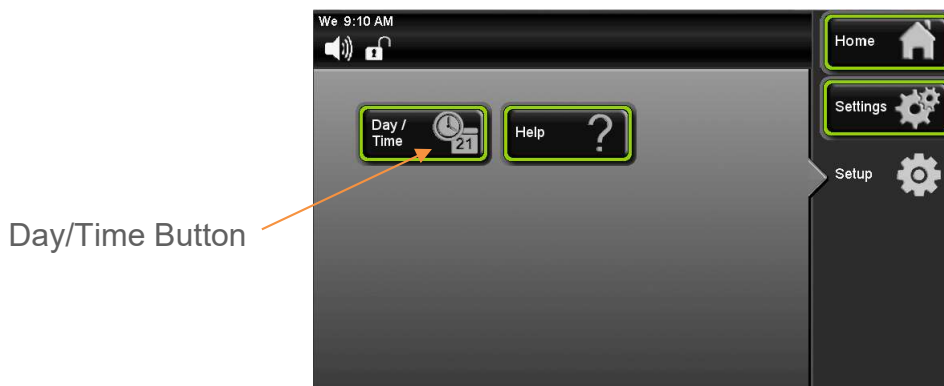



Press the (Day / Time) button.



Hour Button

Minute Button

Day of the Week Button

AM / PM Button



Press the (Hour) button.

The Enter New Time in Hours window will appear. Enter the hour by using the keypad

and pressing  (Enter) when complete.

Follow same procedure for setting up minutes.



To setup AM/ PM, Press (AM /PM) button and the words for AM and PM will toggle back and forth.



To set the Day of the Week, press the (Day of the Week) button. This button will scroll through the days of the week, press until the abbreviated letters correspond to the actual day of the week.



Press the (Home) button to return to the main screen.

Door Heat

Some Caron units are equipped with an integral door heater to keep internal condensation off of the glass viewing area. This is only for units with humidity control. In extreme ambient or running conditions, the factory default settings may need adjusted to maintain a clear viewing area. Increasing the door heater percentage will increase the amount of heat applied to prevent condensation. The door heater can run in either automatic or manual mode. Automatic is the preferred and default setting.



From the Setup screen press the  (Door Heater) button

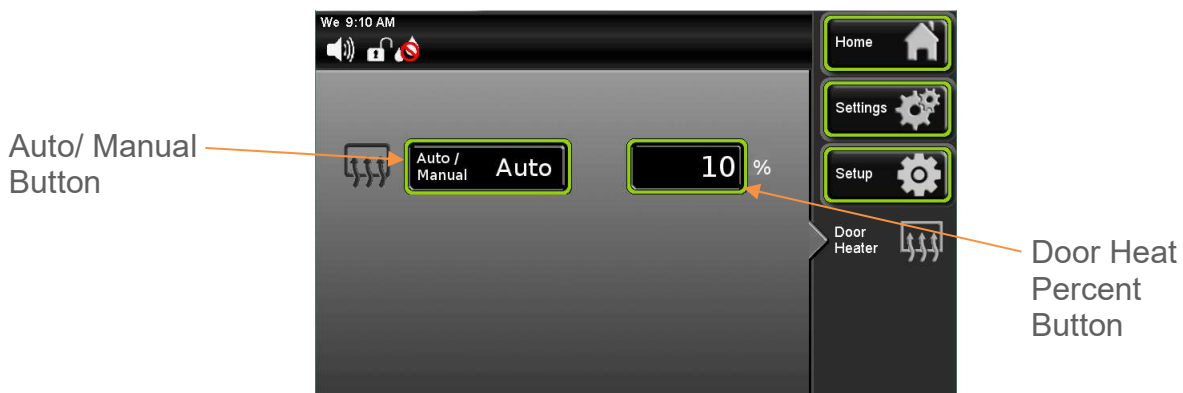

In Automatic mode, the door heater works in conjunction with the internal heaters to maintain the temperature set point. In the event that the temperature is above set point, the door heater will automatically throttle back.

In this mode, the output percent is a scale factor of the overall heat output percentage. If condensation is present on the glass door under stable condition, then increase the door heater percentage value. The factory default value is 10%.

To change the output percent value Press the  (Door Heat Percent) button.

Enter the hour by using the keypad, press the enter button when complete.

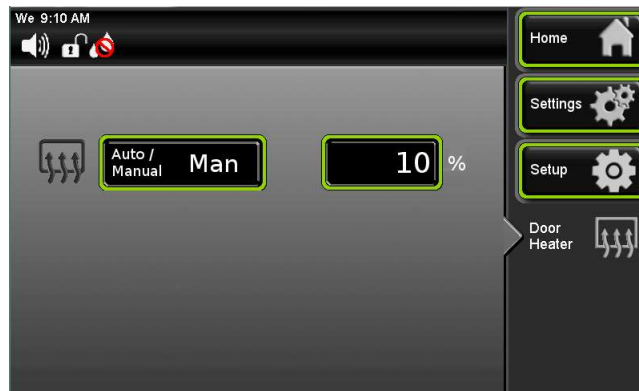

In Manual mode, the door heater is a fixed output value regardless of temperature set point. This setting should only be used in units that have active cooling with temperature set points well above the low-end range.

Warning: in manual mode, the temperature set point may not be maintained.

Humidity Control (models with controlled humidity)

This feature allows the Humidity to be controlled by a setpoint determined by the user, which will be displayed on the home screen. If this feature is disabled, the humidity value on the home screen will be in a “read only” condition. An icon in the status bar will indicate whether the Humidity Control is enabled or disabled

Humidity Control Button

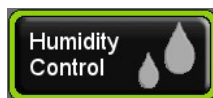

From the Setup screen press the  (Humidity Control) button

Humidity Control disabled icon

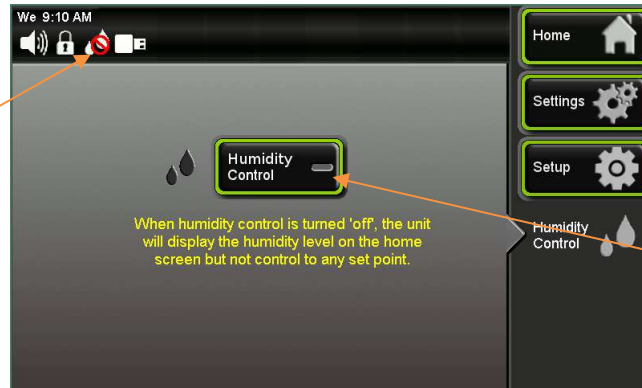

Humidity Control disabled indicator

When the humidity control is disabled the toggle button indicator is off and the humidity control icon in the status bar has a red circle around it.

Humidity Control enabled icon



Humidity Control enabled indicator

When the humidity control is enabled the toggle button indicator is on and the humidity control icon in the status bar has the red circle removed. Once the selection has been made the status of the Humidity control will be visible on the home screen.

Locking the controls

To prevent unauthorized and accidental setpoint changes, the touchscreen can be locked-out. The passcode is required to lock-out the controls and the same passcode is used to unlock it. The factory default passcode is '1234'. This passcode can be changed by the user to create a unique 4-digit passcode. There is also a feature that will let you change the passcode from the factory default to a user defined passcode. The factory default for the screen lock is "unlocked"

To lock the touchscreen,

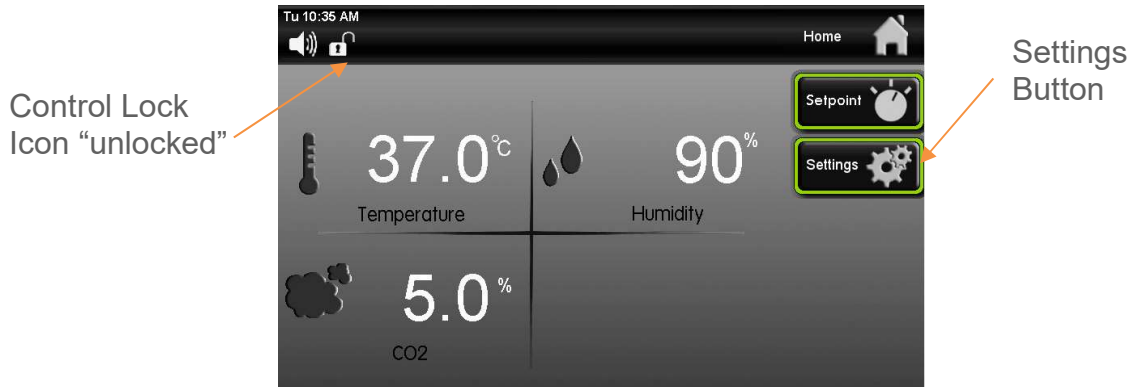

Press the  (Settings) button.



Press the  (Password) button.

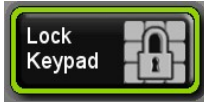
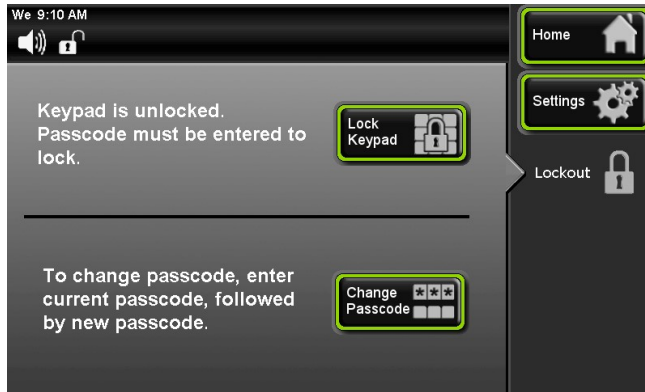

Press the  (Lock Keypad) button.



The Enter the Current Passcode Keypad screen will appear.

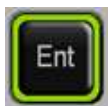

Enter digits “1 2 3 4”; press  (Enter) when complete.

The screen will change back to the Home Screen and the Control Lock icon will change to the “locked” position.

Control Lock Icon “locked”

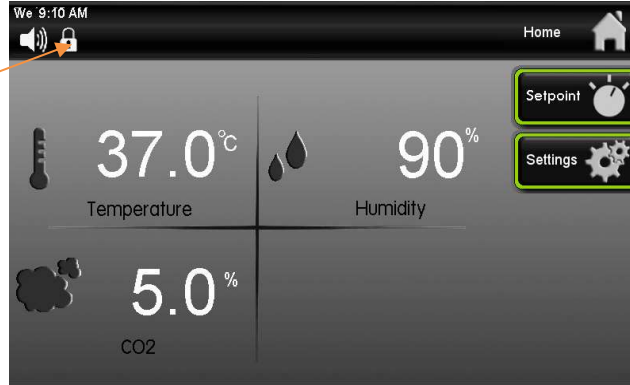

When any button is pressed on the home screen the following pop-up window will appear. If the  button is pressed, the screen will change back to the Home Screen.

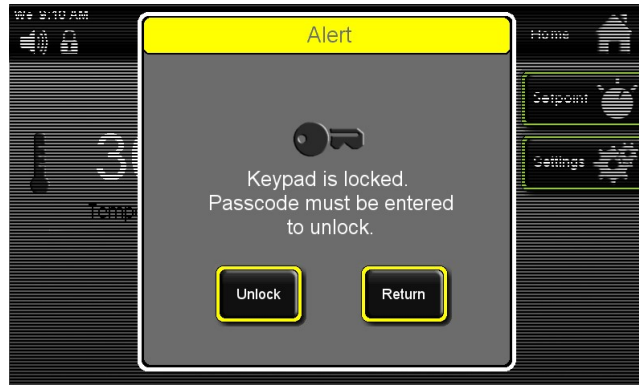

To unlock the touchscreen,



From the previous Alert “Keypad is Locked” pop up screen, press the (Unlock) button. The Enter New Passcode window will pop up.





Enter the digits "1 2 3 4"; press  (Enter) when complete. The Control Lock Icon will change back to the "unlocked" position.

Control Lock
Icon "unlocked"



Changing Passcode

To prevent unauthorized and accidental changes being made to the chamber, the touchscreen can be locked-out. The passcode is required to lock-out the controls and the same passcode is used to unlock it. The factory default passcode is '1234'. This passcode can be changed by the user to create a unique 4-digit passcode. The current passcode is required to change the passcode.

To lock the touchscreen,

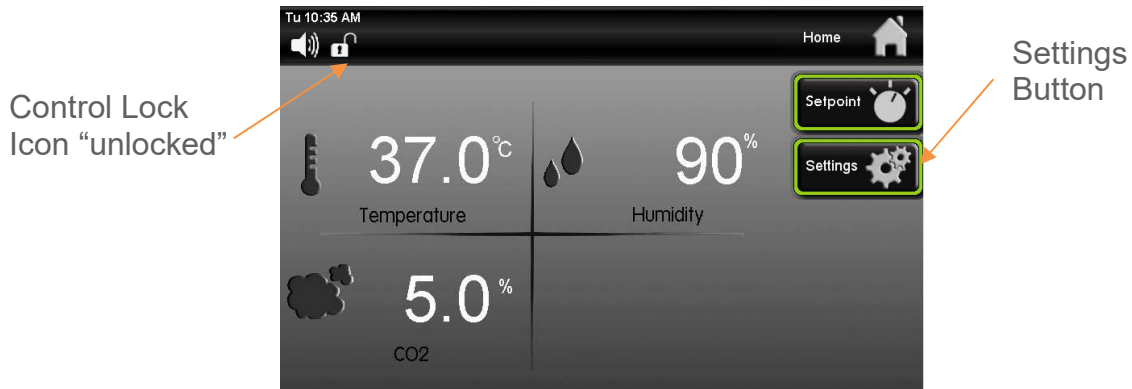

Press the  (Settings) button.



Press the  (Password) button.

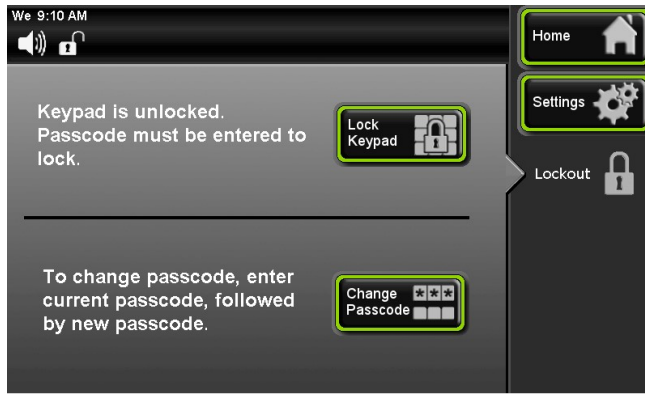

Press the  (Change Passcode) button.



The Enter Current Passcode Keypad screen will appear.



Enter digits "1 2 3 4"; press  (Enter) when complete.



The Enter New Passcode Keypad screen will appear.

Enter any new four-digit passcode (example: “2 5 8 0”). Then press  (Enter) when complete.

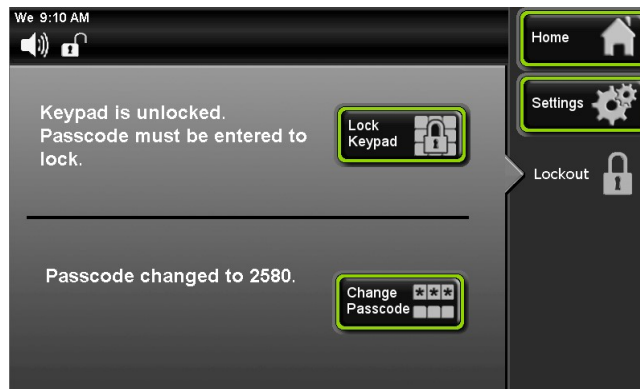

The Lockout screen will tell you that the Passcode has been changed to a new value. *This is only time that the Passcode will be displayed on the Lockout screen.*

Factory menu & troubleshooting

The chamber control system is equipped with advanced diagnostics features which allow the user to manually turn 'on' & 'off' each electronically controlled system. The factory menu can be used to

- View the current chamber configuration
- See the percent output of the control system
- Manually and individually toggle any output

To access the Factory Menu,

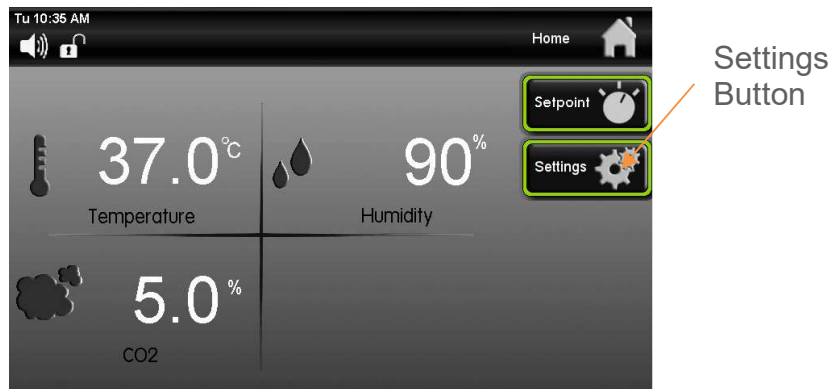

Press the  (Settings) button.

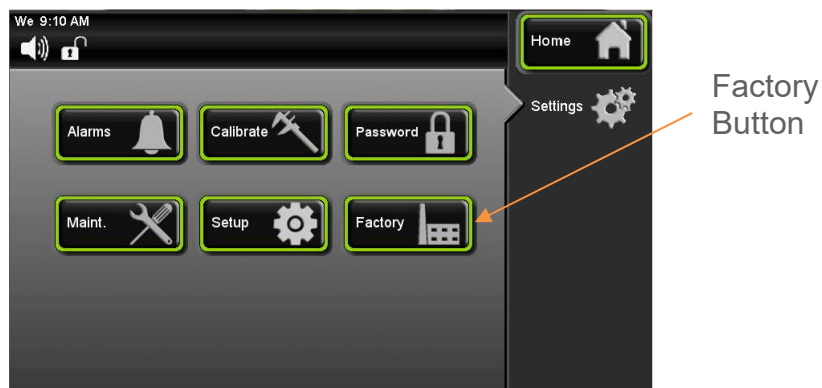

Press the  (Factory) button.

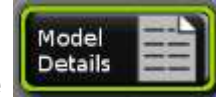
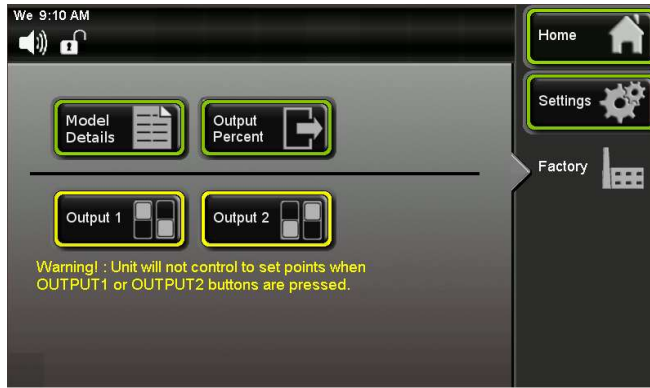

From the factory menu, four items can be selected. Press the **Model Details** (Model Details) button to view the chamber's configuration

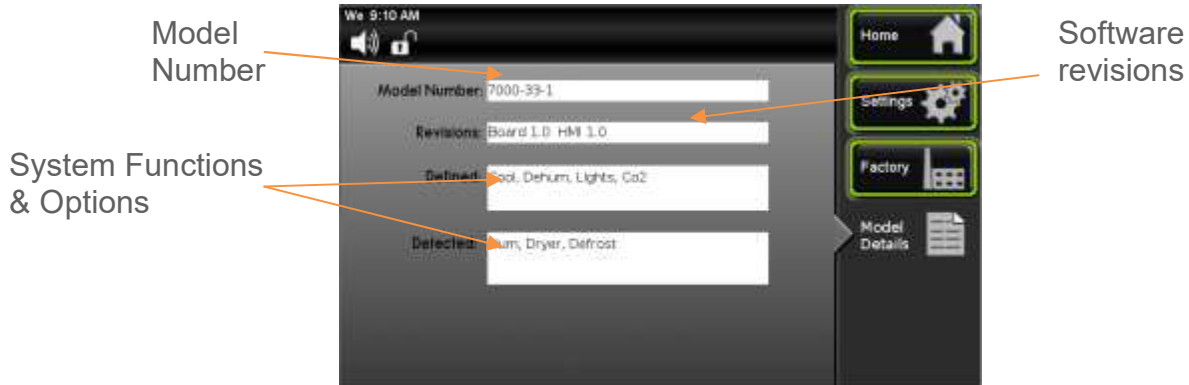

From the Factory screen, press the **Output Percent** (Output Percent) button to view the current percent output level of each control parameter.

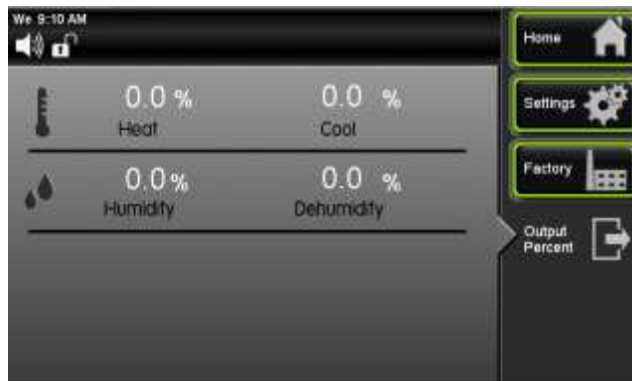

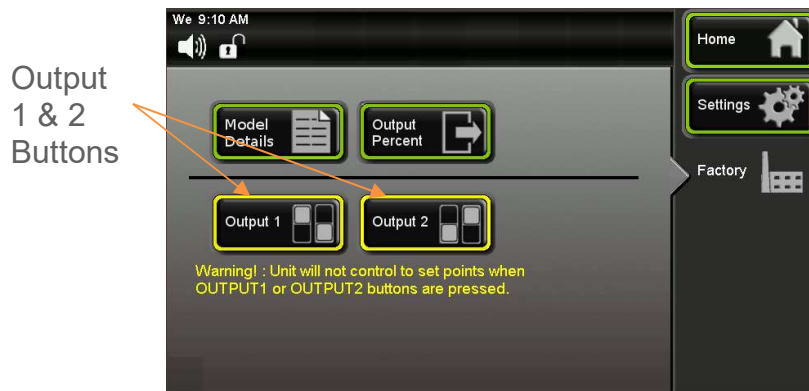

Navigating to the Output 1 or Output 2 screens in the factory page will temporarily halt chamber control & functionality.

To individually and manual control each output variable, from the factory screen press



the  (Output 1) button. Note: Based on the chamber model number and options, not all functions will be present.



Each item can be turned on to check the condition of that device or parameter to aid in diagnosing a problem.



Press the (Output 2) button for other parameter buttons.



Chamber control & functionality is restored as soon as the screen is exited (Home, Settings, or Factory buttons) .When finished with diagnosis in Output 1 or Output 2



screen, press the (Factory) button to return to that screen. Once you go back to the Factory screen all parameters that were selected in Output 1 or Output 2 screens will reset to the “off” position.

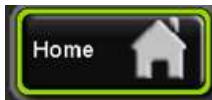

Press the (Home) button to return to the main screen.

PREVENTATIVE MAINTENANCE

Your CARON incubator has been robustly designed to minimize performance problems. However, regular maintenance is very important for continuous trouble free operation.

As a general rule, CARON recommends an annual calibration check of the temperature, humidity, CO₂ systems. CARON offers a full range of on-site calibration and validation services. We also offer preventative maintenance contracts on our equipment. Contact our service department for details at 740-373-6809 or visit us on the web at www.caronproducts.com.

Recommended Daily Maintenance Checks

- Check the Temperature, Humidity, and CO₂ displays versus setpoints.
- Check for and correct any alarm condition.

Recommended Monthly Maintenance Checks

- Check to ensure the drain in the bottom of the unit is draining properly.
- Check front air intake filter. If the filter is dirty replace it with Caron Preventative Maintenance PM Kit. Washing the filter will result in poor performance.

Recommended Annual Maintenance Checks

- If humidity control option, replace atomizer nozzle (Replacement Parts section)
- Disinfect all interior surfaces with a general purpose laboratory cleaning agent.
- Perform a complete calibration of the temperature, humidity, and CO₂ systems.
- A full validation is recommended for GMP facilities each time a unit is installed, moved or undergoes significant repair. Contact CARON's service department to schedule on-site validation.
- Replace UV lamp and clean quartz sleeve (feature optional)

Here is a list of PM Kits that are available for models and accessories covered in this manual.

Model	PM Kit
7400-25	PM-7400-25
7400-33	PM-7400-33
7401-25	PM-7401-25
7401-33	PM-7401-33

Accessory	PM Kit
BOTL301	¹ PM-BOTL301
DECN301	PM-DECN301
EXTD302	³ PM-EXTD302
FLTR301	³ PM-FLTR301
HUMD304	³ PM-HUMD304
HUMD305	⁴ PM-HUMD305
HUMD306	⁵ PM-HUMD306
HUMD307	^{4,5} PM-HUMD307
LGHT602	² PM-LGHT602
RCDR316	PM-RCDR316
RCDR317	PM-RCDR317
RCDR318	PM-RCDR318
RCDR319	PM-RCDR319
STER301	PM-STER301

¹only if humidity options
HUMD304, HUMD307 are installed

²only if LGHT602 is installed

³model 7400

⁴model 7401

⁵model CELL301/302/303/304

SPECIFICATIONS

MODEL	7400-25	7400-33	7401-25	7401-33
Temperature Range	10°C Above Ambient to 60°C		20°C to 60°C gROD	
Temperature Control	± 0.1°C			
Temperature Uniformity	± 0.3°C			
Temperature Sensor	RTD			
Humidity Range	Ambient to 95% RH		none	
Humidity Control	± 3% RH*		none	
Humidity Sensor	Capacitive		none	
CO ₂ Range	0-20% CO ₂			
CO ₂ Control	± 0.1% CO ₂			
CO ₂ Sensor	Infrared			
Interior Dimensions	32" W x 27" D x 52.7" H (81.3 cm x 68.6cm x 133.9cm)	32" W x 27" D x 66" H (81cm x 69cm x 168cm)	32" W x 27" D x 52.7" H (81.3 cm x 68.6cm x 133.9cm)	32" W x 27" D x 66" H (81cm x 69cm x 168cm)
Interior Construction	Type 304, 2B Finish, Solid Stainless Steel			
Exterior Dimensions	35.5" W x 33.3" D* x 77.1" H (90.2cm x 84.6cm x 195.8cm)	36" W x 33" D* x 90" H (90cm x 85cm x 229cm)	35.5" W x 33.3" D* x 77.1" H (90.2cm x 84.6cm x 195.8cm)	36" W x 33" D* x 90" H (90cm x 85cm x 229cm)
Exterior Construction	Cold Rolled Steel, Powder Coated			
Work Space	25 Cu. Ft. (708 Liters)	33 Cu. Ft. (934 Liters)	25 Cu. Ft. (708 Liters)	33 Cu. Ft. (934 Liters)
# of Shelves	Four (4)	Five (5)	2 reinforced	3 reinforced
Shelf Construction	Type 304, Perforated Stainless Steel, Electropolished		Type 304, Perforated Stainless Steel, Electropolished	
Shelf Dimensions	29.25" W x 26.45" D (74.3cm x 62.1cm)		29.25" W x 26.45" D (74.3cm x 62.1cm)	

Electrical

MODEL	7400-25	7400-33	7401-25	7401-33
-1	115V, 60Hz, 16A			
-2	230V, 60Hz, 12A			
-3	230V, 50Hz, 10A			

Weight

MODEL	7400-25	7400-33	7401-25	7401-33
-1	525 lbs (238 kg)	600 lbs (272 kg)	525 lbs (238 kg)	600 lbs (272 kg)
-2				
-3**	825 lbs (374 kg)	900 lbs (408 kg)	875 lbs (397 kg)	1000 lbs (454 kg)

Specifications are subject to change without notice.

Environmental Conditions: Temperature 15°C to 25°C, Humidity non-condensing

**Add 2.75 inches for handle*

***Includes export shipping crate*

7400-25 Series units have forced internal air flow of 350 cfm (9,900 LPM)

7400-33 Series units have forced internal air flow of 450 cfm (13,000 LPM)

ELECTRICAL SCHEMATICS

MAIN CONTROLLER BOARD (CTR-140)

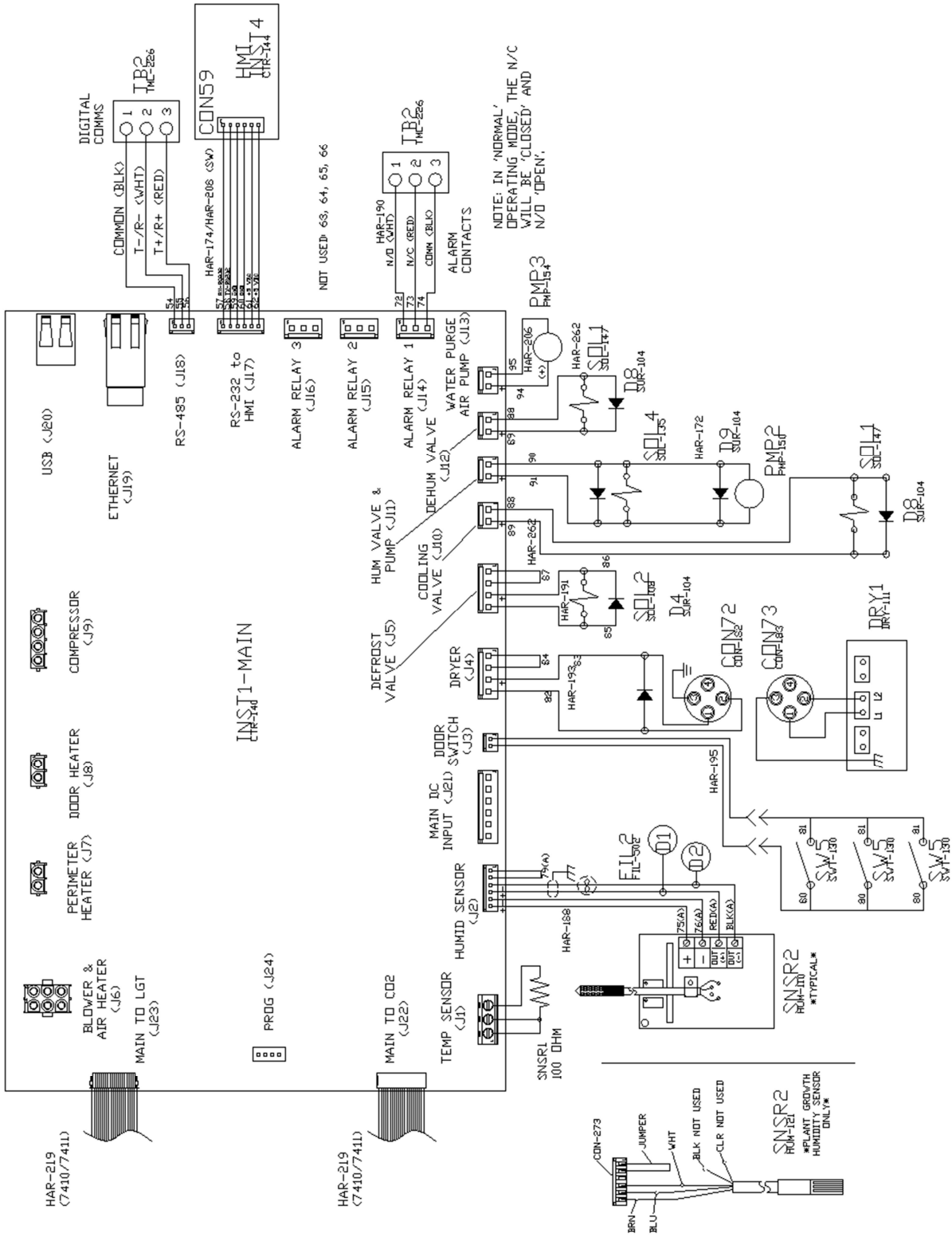

LIGHT CONTROLLER BOARD (CTR-142)

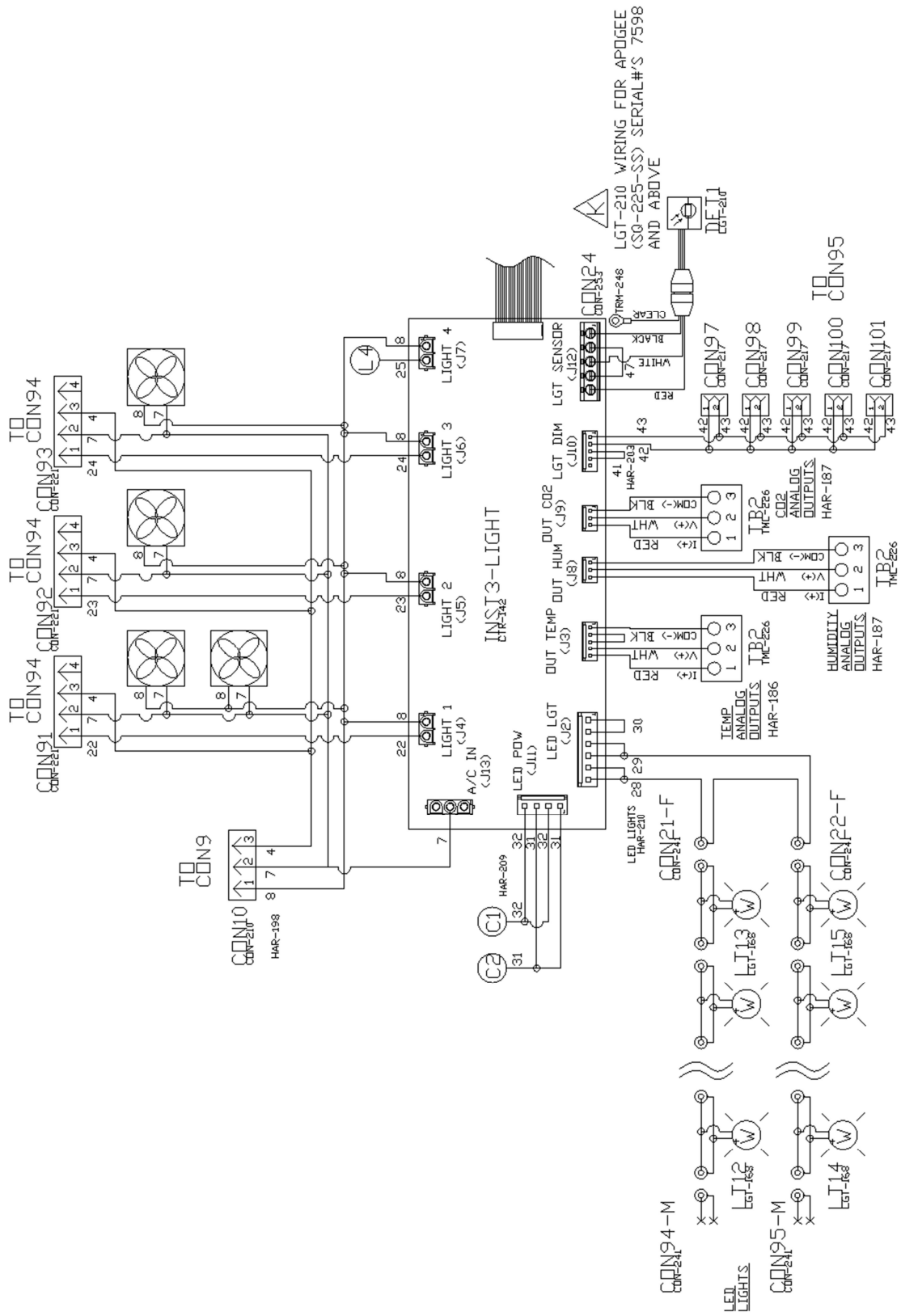

O2 CONTROLLER BOARD (CTR-150)

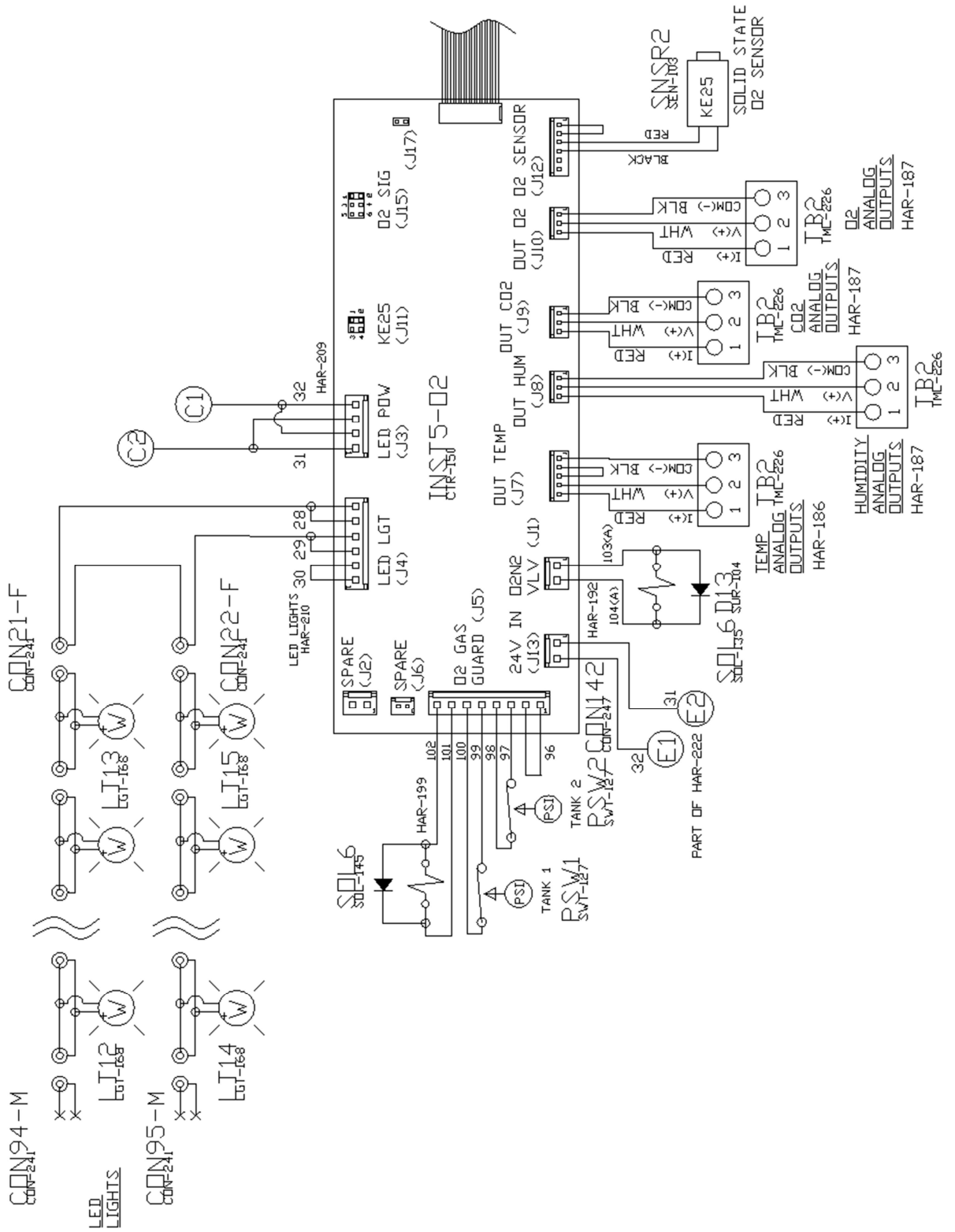

AIR HEATERS

7300-75-2/3, 7300-75-2/3,
7302-75-2/3, 7303-75-2/3
NO HAR-114 ADAPTER HARNESS
EVEN THOUGH IS 230V & 2X
HEATERS

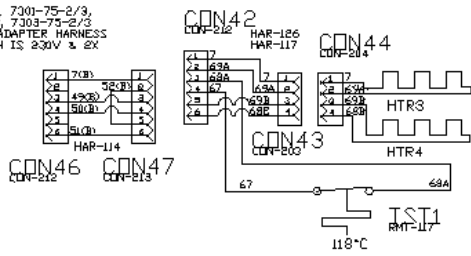

7204-75 FT²3 PLANT GROWTH (1 HEATER)

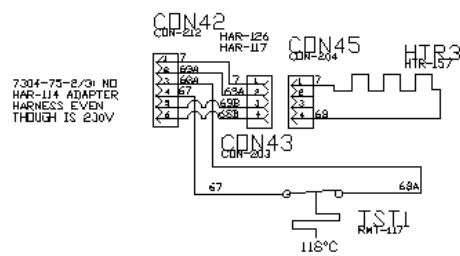

7304-75-2/3H NO
HAR-114 ADAPTER
HARNESS EVEN
THOUGH IS 230V

DOOR HEATER

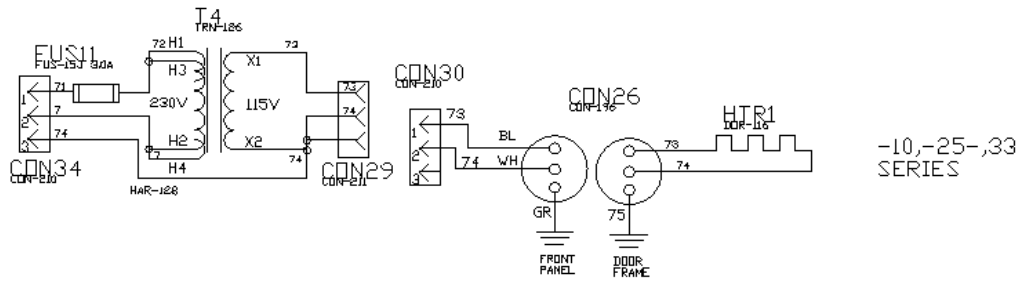

-10,-25,-33
SERIES

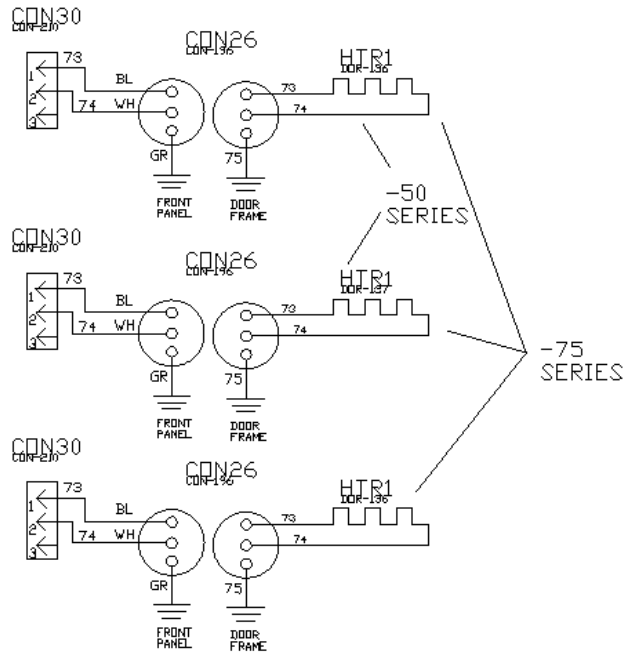
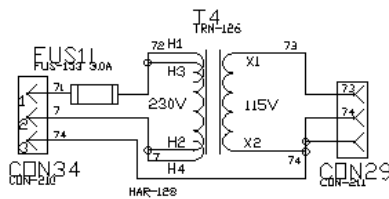

7000 SERIES ELECTRICAL SCHEMATIC (PAGE 7 OF 12) REV Q

CO2 CONTROLLER BOARD (CTR-141)

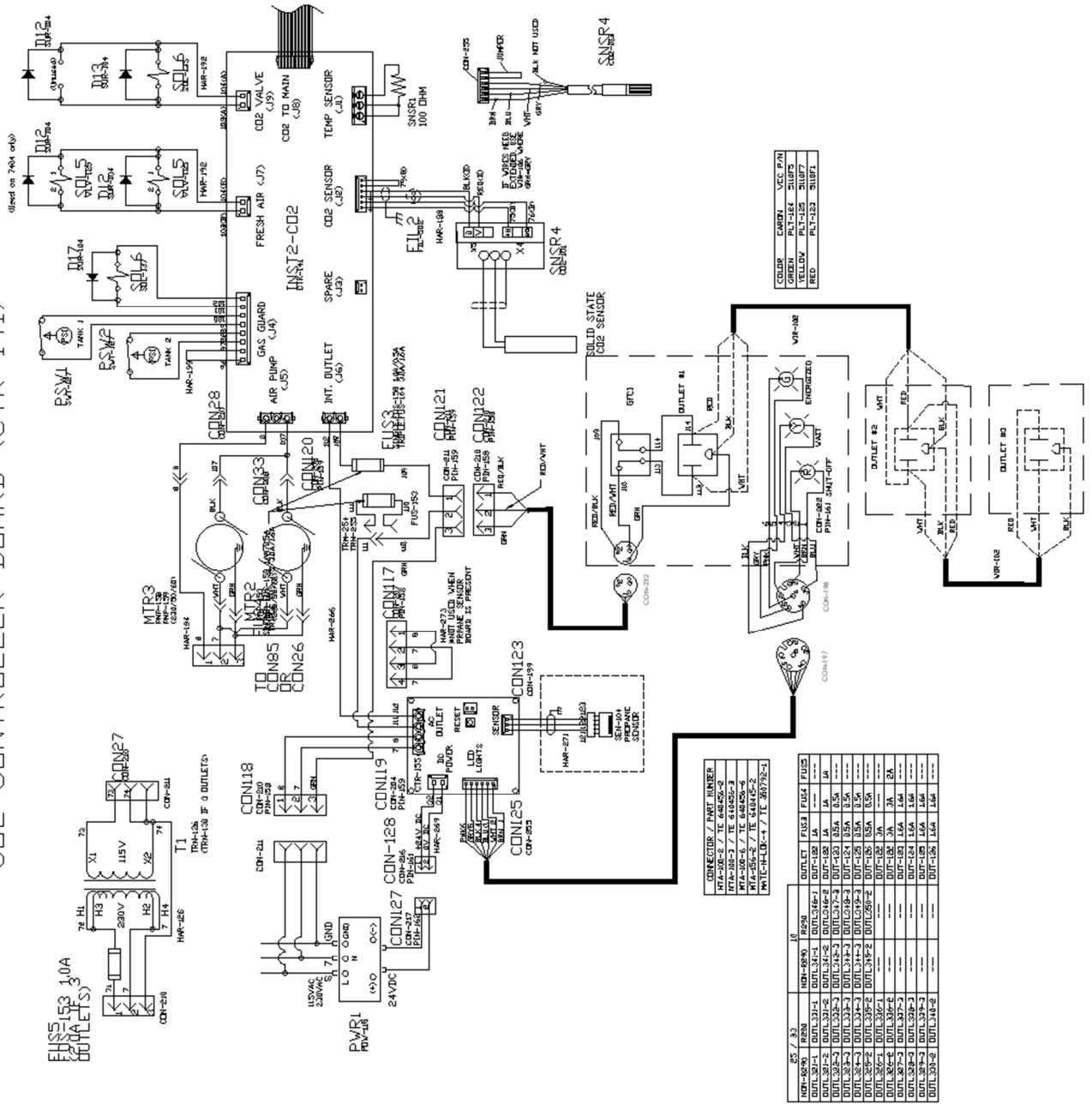

PERIMETER HEATERS

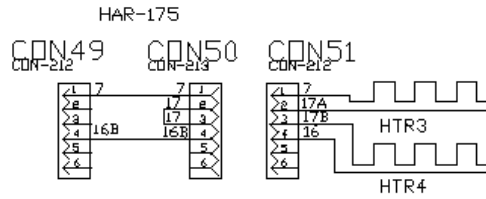

75 FT3 ONLY

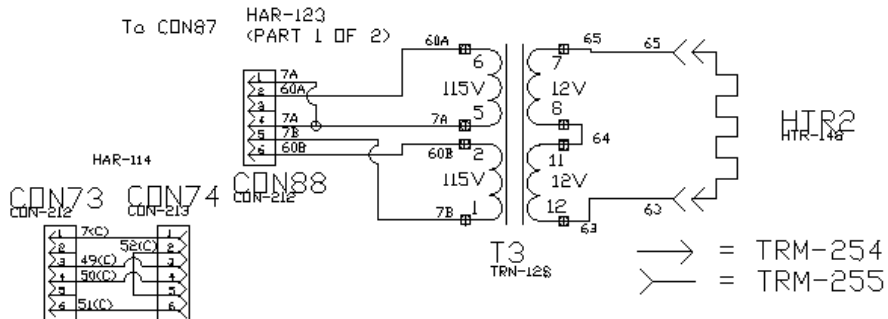
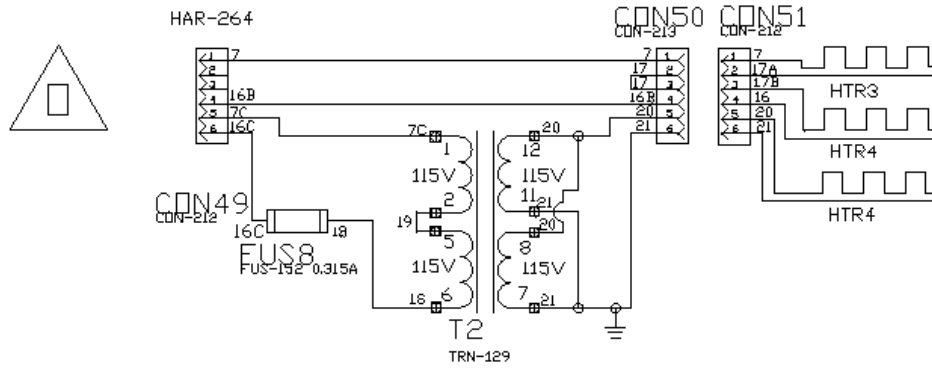

UV LIGHT

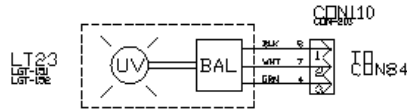

CONDENSATE PUMP

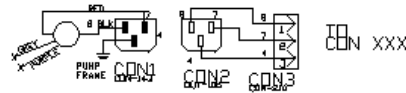

FRONT MOUNT RECORDER

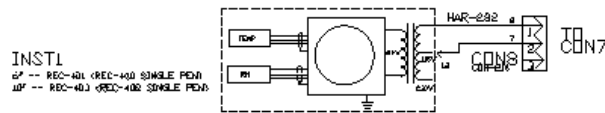

SIDE MOUNT RECORDER

REC-107/103 (RCDR320 & RCDR321)

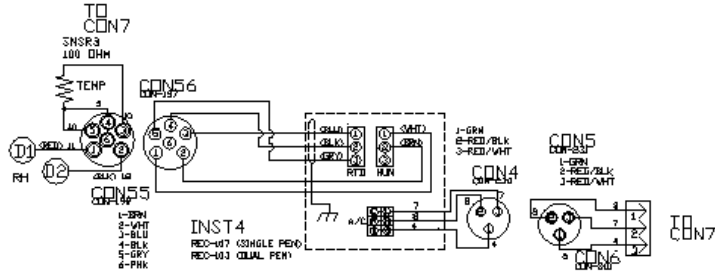

REC-201/202 (RCDR322 & RCDR323)

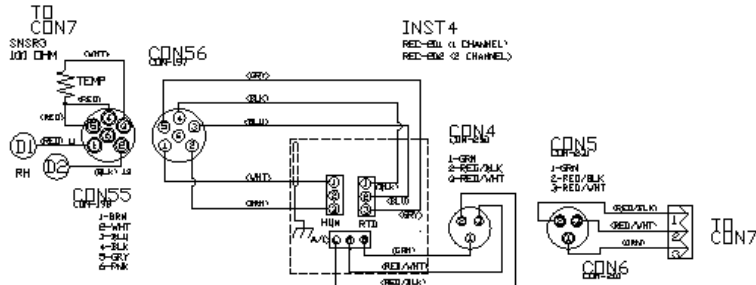

COMMUNICATION OPTION (DLOG301)

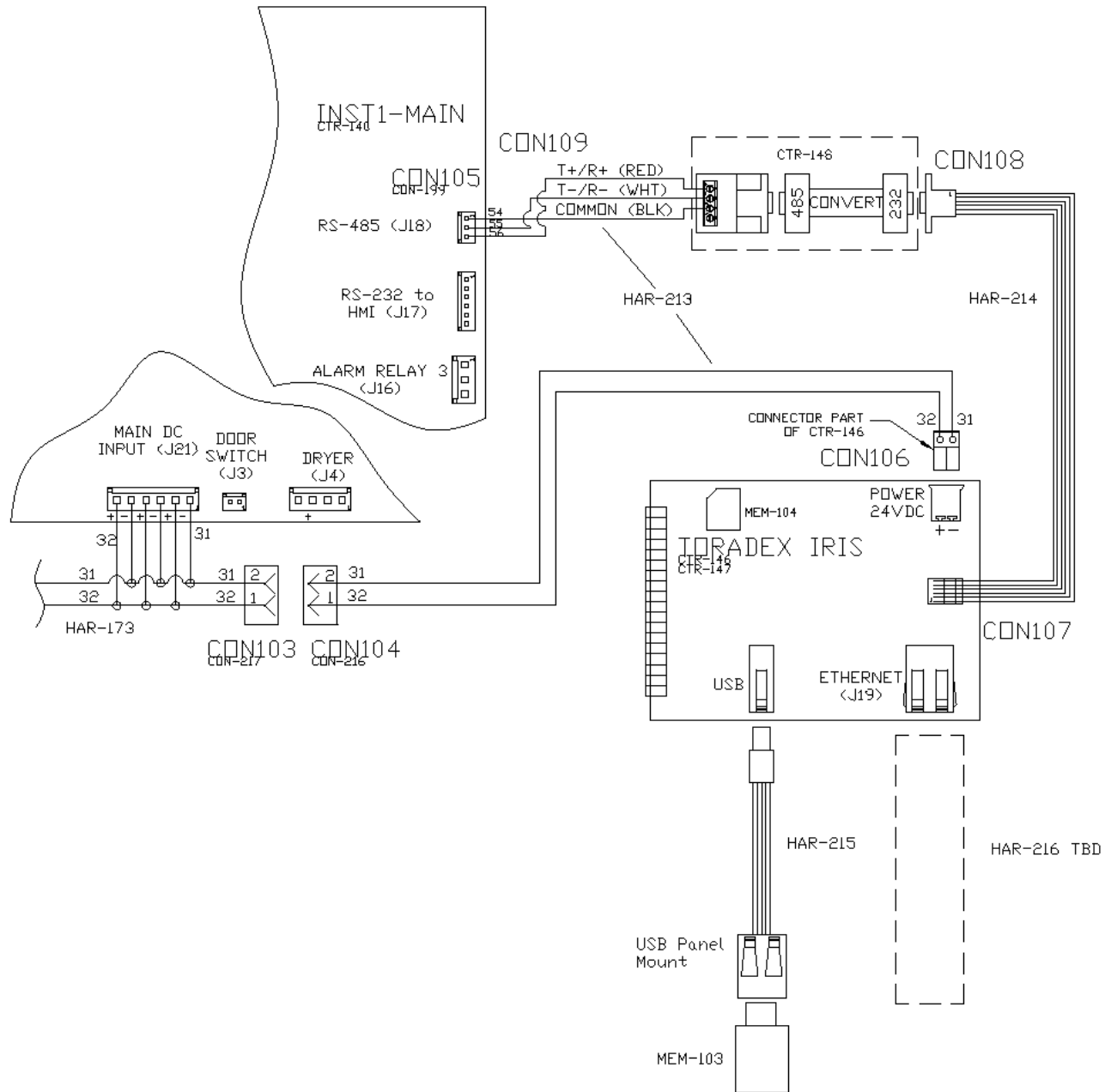

VHP MODULE

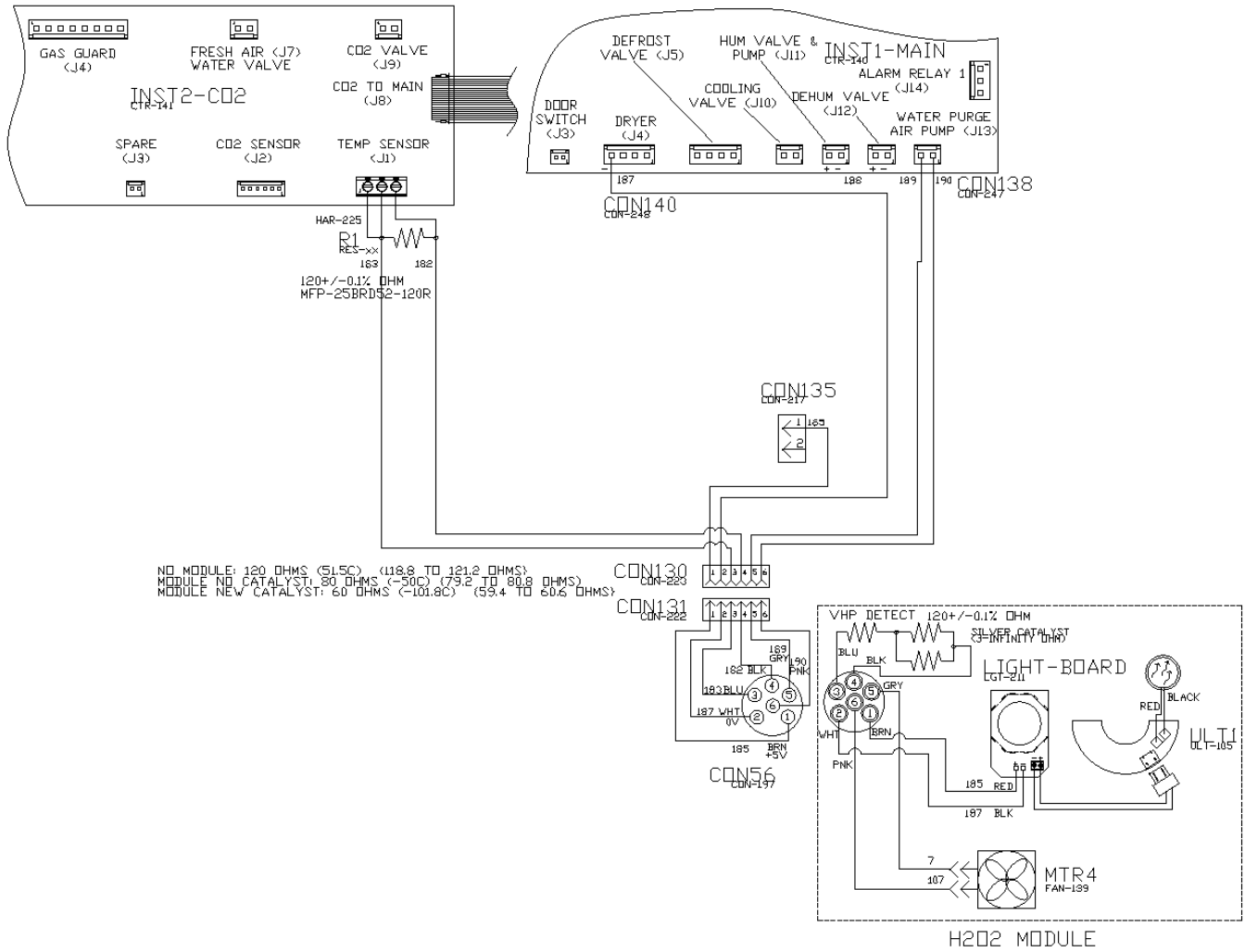

TROUBLESHOOTING

Problem -- Unit will not turn on

- Is the unit connected to a dedicated electrical circuit as defined in the installation section of the manual?
- Is there power at the electric outlet the unit is plugged into?
- Is the unit's power switch turned on?

Problem -- Unit temperature is above / below temperature setpoint

- Has the unit's temperature setpoint been recently lowered / raised and if so has the unit been allowed 12 hours stabilize at the new setpoint?
- Are the access port stoppers installed in the cabinet?
- Is the door closed?
- Is the condenser filter on the front of the cabinet clean?

Unit humidity level is above / below humidity setpoint

- Is the unit connected to a water source as specified in the installation section of the manual?
- Has the unit been leveled to insure the cabinet drain works correctly?
- The cabinet's drain line uses gravity to remove water. Does the drain line have any rises in it above the cabinet's drain level that could be trapping water?
- Has the unit's humidity setpoint been recently lowered / raised and if so has the unit been allowed time to stabilize at the new setpoint?
- Are the access port stoppers installed in the cabinet?
- Is the door closed?
- Is the condenser filter on the front of the cabinet clean?

Unit CO₂ level is above / below the CO₂ setpoint

- Is the unit connected to a pressure regulated CO₂ source as specified in the installation section of the manual?
- Has the unit's CO₂ setpoint been recently lowered / raised and if so has the unit been allowed time to stabilize at the new setpoint?
- Is the door closed?
- Are the access port stoppers installed in the cabinet?

Internal outlet will not energize?

- Is LED sensor light green? Yellow indicates sensor is initializing. Red indicates a problem.
- Has GFCI tripped?
- Is fuse blown?

• SPARE REPLACEMENT PARTS



CAUTION: Before servicing the unit, the mains power supply cord must be unplugged to avoid risk of shock. Any area of the unit that requires a tool to access shall only be serviced by trained personnel approved by Caron Products.



R290 REFRIGERANT UNITS

Do not damage the refrigeration circuit. Component parts shall be replaced with like components and servicing shall be done by authorized personnel to reduce the risk of possible ignition.

General

Part Number	Description
MTR-130	Blower Motor
BLW-112	Blower Wheel
CTR-140	Main Controller Board
CTR-141	CO ₂ Controller Board
CTR-142	Light Controller Board
CTR-144	7" Touchscreen, HMI
POW-115	24V DC Power Supply
FLTR301	Condenser Filter Replacement Kit
CRD-113	Power Line Cord
STP-101	2" Rubber Port Stopper



The mains power supply cord must be replaced by the corresponding CRD part number above. The use of an inadequate mains power supply cord could result in equipment failure or personal harm to the user.

Temperature Related

Part Number	Description
HTR-166	Air Heater
RMT-117	107C Air Heater Thermostat
RTD-101	Temp Sensor -- RTD 100 Ohm Platinum
CMP-125	115V / 60Hz Compressor
SOL-108	Refrigeration Cooling Solenoid

Humidity Related

Part Number	Description
FIL-213	Air Purge Pump Filter
HUM-110	RH Sensor
PMP-150	24VDC RH Pressure Pump
NOZ-110	Precision RH Spray Nozzle
SOL-108	Dehumidification Solenoid
SOL-135	Humidification Solenoid
TUB-168	Drain Tubing, 3/8"
TUB-132	Water Supply Tubing, 1/4"

CO₂ Related

Part Number	Description
CO2-101	Carbon Dioxide Sensor
SOL-135	CO ₂ Injection Solenoid
FIL-213	In-line CO ₂ Filter

Fuse Related

ID	Description	115V	230V
SW1	Main circuit breaker switch	CBR-112 (16A)	CBR-115 (10A)
FUS1	Heater fuse	FUS-103 (10A)	FUS-104 (5A)
FUS3*	Internal outlet fuse (single duplex)	FUS-151 (2A)	FUS-151 (2A)
FUS3*	Internal outlet fuse (double duplex)	-	FUS-163 (4A)
FUS5	Internal outlet transformer fuse	-	FUS-164 (3A)

* Fuse size varies depending upon whether the chamber has a single internal duplex outlet or two internal duplex outlets

Options Related

Part Number	Description	Option
CLM-132	Nylon tube clamp	GASG301, REGL101
FIL-118	HEPA filter	DECN301-1,DECN301-4
FIT-348	1/4" barb-1/4" push-in adapter	GASG301, REGL101
MEM-103	USB Flash Drive	DLOG301
PEN-103	Red pen for 6 inch recorder	RCDR316, RCDR317
PEN-104	Blue pen for 6 inch recorder	RCDR317
PPR-104	6 inch recorder paper, 7 day 0-60C	RCDR316
PPR-105	6 inch recorder paper, 7 day 0-100C	RCDR317
PPR-106	10 inch recorder thermal paper	RCDR318, RCDR319
TUB-174	1/2" I.D. silicone tubing	PUMP301
TUB-145	1/4" I.D. vinyl tubing	GASG302, REGL101
TUB-174	1/2" I.D. silicone tubing	PUMP301
WIR-102	20/3 conductor shielded wire	ALRM302



EU DECLARATION OF CONFORMITY

Caron Products and Services, Inc.
27640 State Route 7
Marietta, OH 45750 USA

Declares that the product:

Designation: 7400 Series
Model Numbers: 7400-25-3, 7400-33-3, 7401-25-3-3, 7401-33-3
Classification: Electrical equipment intended for residential, commercial and lighting industrial environments
Rated Voltage: 220-240 ~ (ac)
Rated Frequency: 50/60Hz

Meets the essential requirements of the following European Union Directive(s) using the relevant section(s) of the normalized standards and related documents shown:

Directives: Low Voltage 2014/30/EU, EMC 2014/30/EU, RoHS 2011/65/EU

Standard: IEC 61010-1:2010

Safety requirements for electrical equipment for measurement, control, and laboratory use.
Part 1: General Requirements.

Standard: IEC 601010-2-012:2016

Safety requirements for electrical equipment for measurement, control, and laboratory use -
Part 2-012: Particular requirements for climatic and environmental testing and other temperature conditioning equipment

Standard: EN 61326-1:2012

Electrical equipment for measurement, control and laboratory use - EMC requirements -
Part 1: General requirements

Signed for and on the behalf of Caron.

0

Date of issue: April 1,2021 in Marietta, OH, USA

By: Bob Dotterer
Engineering Manager, CARON



DECLARATION OF CONFORMITY

Caron Products and Services, Inc.
27640 State Route 7
Marietta, OH 45750 USA

Declares that the product:

Designation: 7400 Series
Model Numbers: 7400-25-3, 7400-33-3, 7401-25-3-3, 7401-33-3
Classification: Electrical equipment intended for residential, commercial and lighting industrial environments
Rated Voltage: 220-240 ~ (ac)
Rated Frequency: 50/60Hz

Meets the essential requirements of the following UK legislation using the relevant section(s) of the UK designated standards and related documents shown:

UK legislation: Electrical Equipment (Safety) 2016, EMC 2016, RoHS 2012

Standard: IEC 61010-1:2010

Safety requirements for electrical equipment for measurement, control, and laboratory use.
Part 1: General Requirements.

Standard: IEC 601010-2-012:2016

Safety requirements for electrical equipment for measurement, control, and laboratory use -
Part 2-012: Particular requirements for climatic and environmental testing and other temperature conditioning equipment

Standard: EN 61326-1:2012

Electrical equipment for measurement, control and laboratory use - EMC requirements -
Part 1: General requirements

Signed for and on the behalf of Caron.

Date of issue: December 30, 2021 in Marietta, OH, USA

By: Bob Dotterer
Engineering Manager