

ENERGIZER L92

Ultimate Lithium



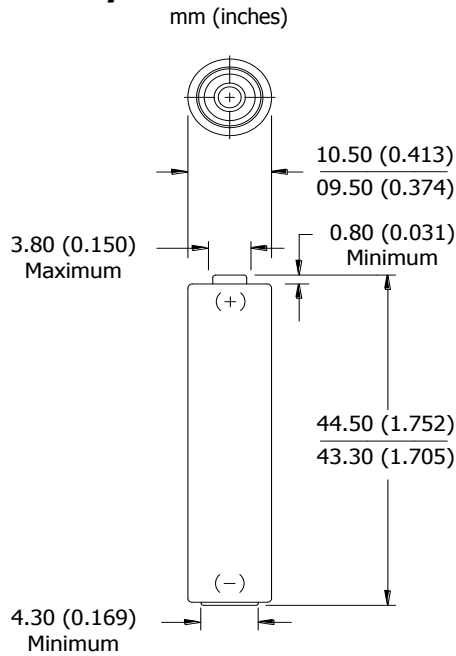

AAA

Industry Standard Dimensions



Specifications

Classification:	"Cylindrical Lithium"
Chemical System:	Lithium/Iron Disulfide (Li/FeS ₂)
Designation:	ANSI 24-LF, IEC-FR03
Nominal Voltage:	1.5 Volts
Compatible With:	E92 , NH12 , 1212
Storage Temp:	-40°C to 60°C (-40°F to 140°F)
Operating Temp:	-40°C to 60°C (-40°F to 140°F)*
Typical Weight:	7.6 grams (0.3 oz.)
Typical Volume:	3.8 cubic centimeters (0.2 cubic inch)
Max Discharge:	1.5 Amps Continuous
(single battery only)	2.0 Amps Pulse (2 sec on / 8 sec off)
Max Rev Current:	2 uA
Lithium Content:	Less than 1 gram
Typical IR:	140 to 180 milliohms (depending on method)
Shelf Life:	20 years at 21°C
Shipping:	Please refer to PSDS Document
Certifications:	  <small>II TG Ex Ia IIC Ga Baseefa 14ATEX0107U</small>

*All data shown tested at 21°C unless otherwise stated.

Milliamp-Hours Capacity

Constant Current Discharge to 0.8 Volts

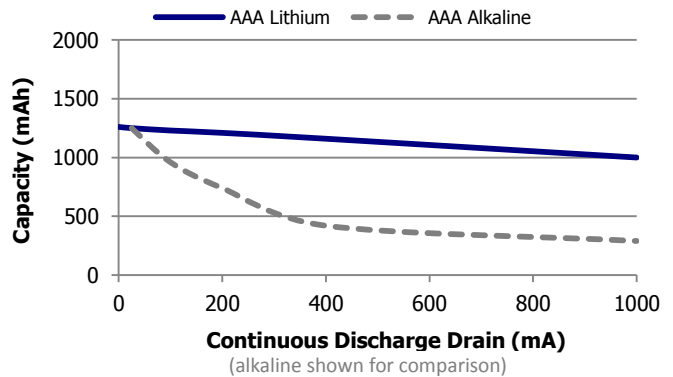

Discharge Profile

Constant Current Discharge

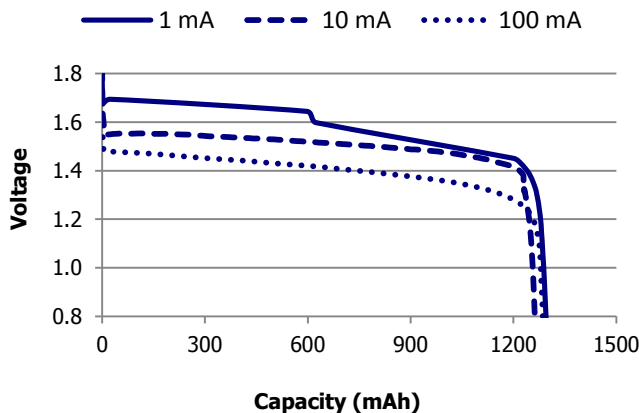

Temperature Effects on Capacity

Constant Current Discharge

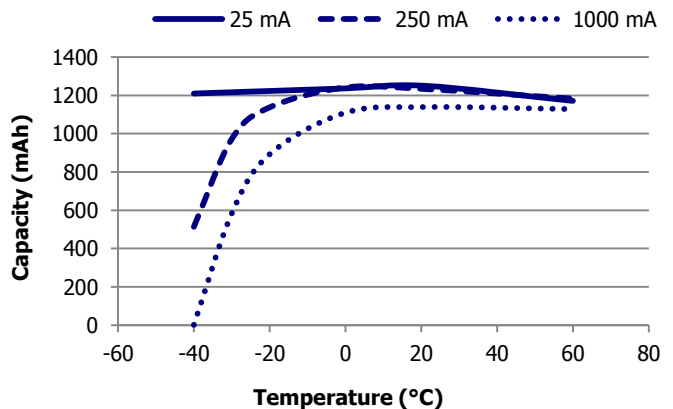

Important Notice

This datasheet contains typical information specific to products manufactured at the time of its publication.
Contents herein do not constitute a warranty and are for reference only.

ENERGIZER L92

AAA

Internal Resistance Profile

Cell Ohmic Resistance

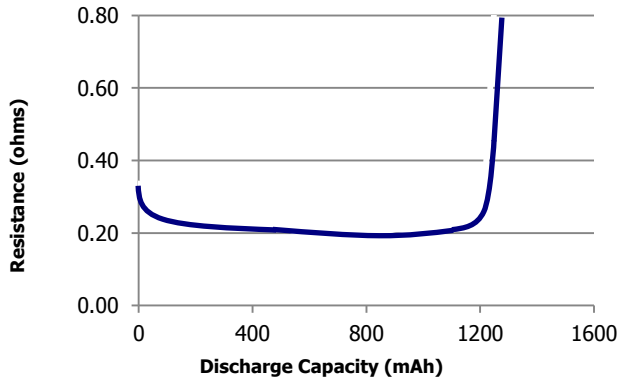

Pulse Response

Open Circuit Voltage - 100/500/1k mA Pulse

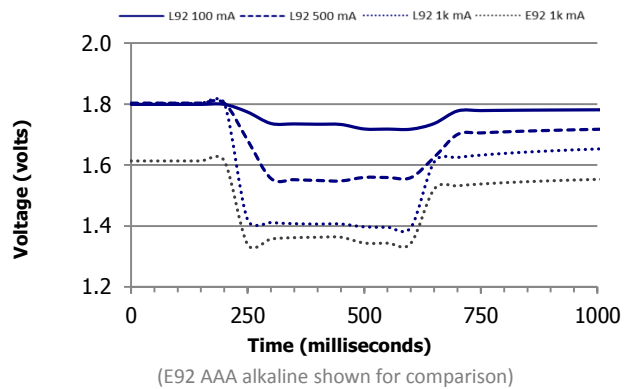

Constant Power Performance

Typical Characteristics to 0.8 Volts

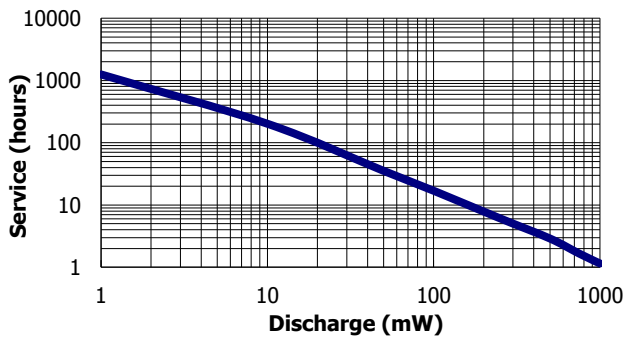

Constant Current Performance

Typical Characteristics to 0.8 Volts

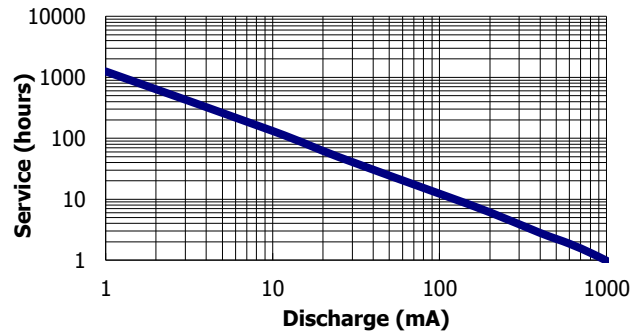

Application Tests

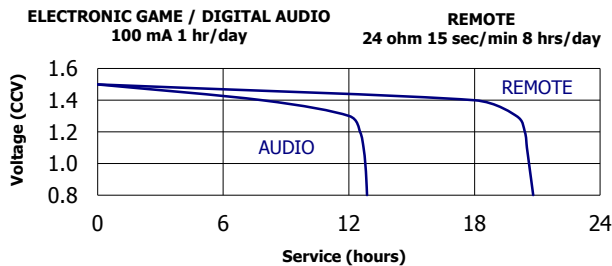

Industry Standard Tests

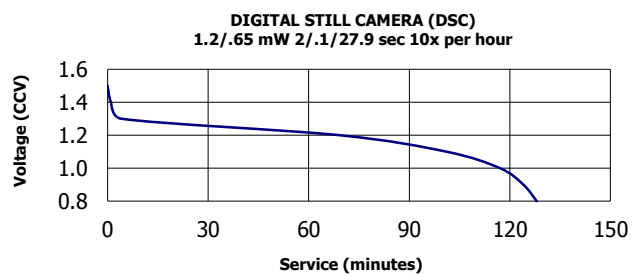
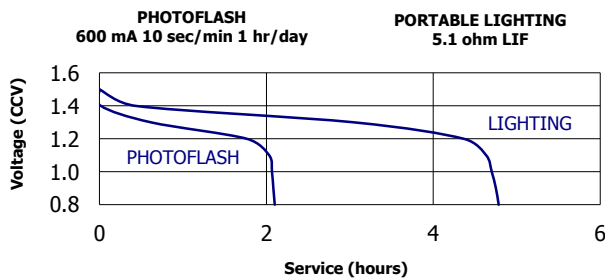
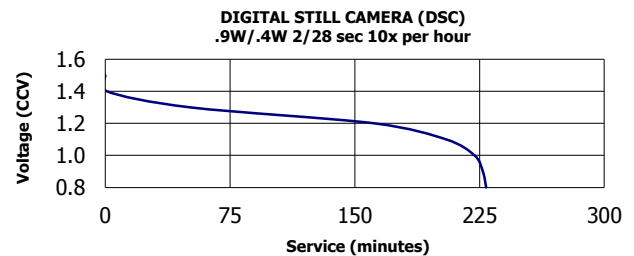

Important Notice

This datasheet contains typical information specific to products manufactured at the time of its publication. **Contents herein do not constitute a warranty and are for reference only.**