

ULTIMA series
USER MANUAL



Date of last revision: January 2019

In order to ensure that our products are continually improved, GETINGE LANCER reserves the right to make any changes to their features relating to technical developments

Drawings and photos are non-contractual

ORIGINAL INSTRUCTIONS

SUMMARY

CHAPTER 1 PRESENTATION OF THE ULTIMA SERIES	5
CHAPTER 2 GENERAL INFORMATION	7
1. GENERAL CONSIDERATIONS	7
1.1 COPYRIGHT – LIABILITY	7
1.2 DECLARATION OF CONFORMITY	7
1.3 MANUFACTURER	7
2. SAFETY WARNINGS	7
2.1 CORRECT USAGE	7
2.2 OPERATOR TRAINING	8
3. PRODUCT & ADDITIVE LIABILITY	8
4. SYMBOL	8
CHAPTER 3 ULTIMA SERIES WASHERS	9
1. OPERATOR INTERFACES	9
1.1 CONTROL PANNEL	9
1.2 TOUCH SCREEN	10
1.3 ICON LIST	11
1.4 ALPHANUMERIC KEYPAD	12
1.5 BUTTON ON / OFF	12
1.6 EMERGENCY STOP BUTTON	13
2. SAFETY ADVICES	13
2.1 PRECAUTIONS FOR USE	14
2.2 SAFETY LABELLS	14
2.3 USE	14
2.4 MAXIMUM CHARGE	15
3. OPENING OF THE DOOR	15
4. WASHING PRODUCTS	17
4.1 PRODUCT TANK AREA	17
4.2 WASHING PRODUCTS CATEGORIES	18
4.3 INSTRUCTIONS TO RESPECT IN CASE OF HANDLING THE WASHING PRODUCTS	19
4.4 CHANGE OF THE TANKS	19
4.5 HOW TO CHANGE CHEMICAL CONTAINER	19
5. BUILT-IN PRINTER (IF APPLICABLE)	20

5.1	CHECKING THE PRINTER	20
5.2	CHOICE OF THE SUITABLE PAPER ROLLS	20
5.3	REMOVING PAPER AND CLEARING PAPER JAMS	20
5.4	LOADING PAPER	20
5.5	OPERATING MODES	20
5.6	PRINTER MAINTENANCE	20
6.	EXTERNAL PRINTER (IF APPLICABLE)	21
6.1	CHECKING THE PRINTER	21
6.2	CHOICE OF THE SUITABLE PAPER ROLLS	21
6.3	REMOVING PAPER AND CLEARING PAPER JAMS	21
6.4	LOADING PAPER	21
6.5	OPERATING MODES	21
6.6	PRINTER MAINTENANCE	21
6.7	NOTE PRINTING	22
7.	USING OF THE ACCESSORIES	23
7.1	SOME EXAMPLES	23
7.2	FITTING THE BASKETS	25
7.3	LOADING GLASSWARE	27
CHAPTER 4 WASHER UTILIZATION		29
1.	FUNCTIONS ACCESS BY LEVEL CODE	29
2.	CONNECTING TO THE MAINS	29
3.	ACCESSIBILITY TO THE WASHER	30
3.1	BASIC SECURITY (LEVEL 1)	30
3.2	HIGH SECURITY (LEVEL 2)	31
4.	WASHER INFORMATION	32
CHAPTER 5 LAUNCHING A CYCLE.....		33
1.	CYCLES PRESENTATION	33
2.	LAUNCHING A CYCLE	34
3.	DURING THE CYCLE	35
4.	END OF CYCLE	36
CHAPTER 6 ACCESS TO THE USER.....		37
1.	SAMPLING DURING THE CYCLE	37
2.	READING WASHING PROGRAMS	38
3.	ADDITIVE PUMP PRIMING	41

4. TICKET PARAMETERS	42
4.1 TICKET HEADER	42
4.2 TICKET FOOTER	43
4.3 REPRINTING TICKETS	43
4.4 EXPORT TICKET ON USB KEY	44
4.1 VISUALIZATION OF CYCLES TICKETS	45
5. USER SETUP	46
CHAPTER 7 TRACEABILITY	49
1. MACHINE TRACEABILITY DOCUMENT	49
2. VIA SUPPORT USB	50
3. PRINTER (IF APPLICABLE)	51
4. THE PRO KIT (IF APPLICABLE) (<i>OPTION ONLY FOR 810-815-820-910-1300-1400 LX MODELS</i>)	52
5. VALIDATION MONITOR, PRINTER (IF APPLICABLE) (<i>OPTION ONLY FOR 1400-1600LXP -1800LXA MODELS</i>)	53
CHAPTER 8 ALARMS	55
1. INCIDENTS	55
2. ALARMS HISTORY	55
3. WARNINGS	57
4. ALARMS TABLE	59
CHAPTER 9 MAINTENANCE OF THE WASHER.....	63
1. CHAMBER FILTERS	63
2. REGENERATING OF SOFTENER (OPTION)	64
3. STRAINER FILTERS	64
4. DRYING AIR FILTERS	64
5. EXTERNAL MAINTENANCE OF THE WASHER	65
5.1 CLEANING THE TOUCH SCREEN PANEL	65
5.2 CLEANING METHOD	65
5.3 CLEANING PRODUCTS FOR EXTERIOR PANELS	65
6. SHUT DOWN AT END OF DAY	66
7. PREVENTIVE MAINTENANCE	66
8. PREVENTATIVE MAINTENANCE SCHEDULE	67

9. RECOMMENDED SPARE PARTS	68
9.1 RECOMMENDED SPARE PARTS 810 LX – 815 LX	68
9.2 RECOMMENDED SPARE PARTS 820 LX	68
9.3 RECOMMENDED SPARE PARTS 910 LX	69
9.4 RECOMMENDED SPARE PARTS 1300 LX	69
9.5 RECOMMENDED SPARE PARTS 1400 LX / 1400 LXP	70
9.6 RECOMMENDED SPARE PARTS 1600 LXP	70
9.7 RECOMMENDED SPARE PARTS 1800 LXA	71
10. DISPOSAL OF WASHER	72
CHAPTER 10 WASHING PROGRAMS.....	73
1. FACTORY PROGRAMMED CYCLE	73
1.1 CONSUMPTION OF WATER PER OPERATION AND MODEL	73
1.2 LABELLING OF WATERS ACCORDING TO STANDARD AND OPTIONS	73
1.3 810 LX - FACTORY PROGRAMMED CYCLE	74
1.4 815 LX - FACTORY PROGRAMMED CYCLE - STANDARD	75
1.5 815 LX - FACTORY PROGRAMMED CYCLE – 120V MONO/60HZ	76
1.6 820LX - FACTORY PROGRAMMED CYCLE	77
1.7 910 LX - FACTORY PROGRAMMED CYCLE	78
1.8 1300 LX - FACTORY PROGRAMMED CYCLE - STANDARD	79
1.9 1300 LX - FACTORY PROGRAMMED CYCLE – SOFTENER OPTION	80
1.10 1400 LX - FACTORY PROGRAMMED CYCLE - STANDARD	81
1.11 1400 LX - FACTORY PROGRAMMED CYCLE – SOFTENER OPTION	82
1.12 1400 LXP - FACTORY PROGRAMMED CYCLE – STANDARD	83
1.13 1400 LXP - FACTORY PROGRAMMED CYCLE – SOFTENER OPTION	84
1.14 1600 LXP - FACTORY PROGRAMMED CYCLE - STANDARD	85
1.15 1600 LXP - FACTORY PROGRAMMED CYCLE – SOFTENER OPTION	86
1.16 1800 LXA - FACTORY PROGRAMMED CYCLE - STANDARD	87
1.17 1800 LXA - FACTORY PROGRAMMED CYCLE – SOFTENER OPTION	88
2. USER CYCLE PROGRAMMING TABLE	89

CHAPTER 1

PRESENTATION OF THE ULTIMA series

You have in your possession a GETINGE LANCER ULTIMA series washer.

The ULTIMA series washer and ULTIMA series washer/dryer has been designed to meet and exceed the growing requirements of the Laboratory industry for cleaning of glassware in the chemistry, microbiology, quality control and analytical laboratories

A wide range of washers and washer-dryers for laboratory glassware:



Undercounter
810LX – 815 LX – 820 LX

Free-standing
910 LX – 1300 LX – 1400 LX – 1400 LXP – 1600 LXP – 1800 LXA

Fully programmable, easy to use, ULTIMA series features technological innovations as the injector drying system (except 810LX and 815 LX), using hot HEPA filtered air, or the automatic electric door locking for the users comfort and safety.

Some of the main features of ULTIMA series washers:

- User friendly touch screen that provide comprehensible help in resolving problems and allow operators to see machine status from a distance :
 - Horizontal 3,5" color touch screen for 810 LX / 815 LX / 820 LX / 910 LX / 1300 LX / 1400 LX
 - Horizontal 7" color touch screen for 1400 LXP / 1600 LXP
 - Vertical 7" color touch screen for 1800 LXA
- 40 microprocessor-controlled programs, of which 4 are factory preset and 36 can be user-customized (PIN code protected) to suit particular applications or loads.
- PLC microprocessor designed for simplicity, one-touch start and real-time status indicators
- Multiple loading configurations thanks to independent washing levels, the upper levels can be positioned in different positions.

Its good working and your entire satisfaction depend on the attention you pay when reading this guide.



This manual is common to all GETINGE LANCER washers of the ULTIMA range.

Despite the fact that the screens sizes and orientations of our washers are different, the information displayed remains the same.

Some variants may appear for the model 1800LXA, in this case they will be the subject of a particular paragraph.

This manual uses the 3.5 " touch screen print shots.

CHAPTER 2

GENERAL INFORMATION

1. GENERAL CONSIDERATIONS

1.1 COPYRIGHT – LIABILITY

All rights reserved.

GETINGE LANCER pays close attention to all technical developments and continuously seeks to improve its products and services in order to provide an adequate response to the needs of its clients. GETINGE LANCER therefore reserves the right to modify the related documentation without prior notice.

1.2 DECLARATION OF CONFORMITY

This ULTIMA series washer has been developed and manufactured following the standards (CE or UL).

For the washers in conformity with the CE standards, a “CE conformity declaration” is delivered with the machines.



1.3 MANUFACTURER

This ULTIMA series washer is manufactured in our Center of Excellence:

GETINGE LANCER
30, Bd de l'Industrie
Zone industrielle Pahin Concerto
31170 Tournefeuille - France

2. SAFETY WARNINGS

2.1 CORRECT USAGE

The installation of the ULTIMA series washer must be achieved in accordance with the procedures described in the installation manual delivered with the machine.

This section contains important information on how to operate your washer. Follow the instructions in this manual carefully for best outcome.

ULTIMA series washers are equipped with a number of safety devices. To avoid injury, do not by-pass or disable these devices.

Do not tamper with or attempt to modify these devices, as this could prove dangerous.

Before launching a cycle, check the opening of the waters intakes, steam intake, pneumatic intake taps and electrical supply.

2.2 OPERATOR TRAINING

Read these instructions carefully before use.

The ULTIMA series washer must only be used by experienced and trained staff.

This training is left to the discretion of the facility based on need and staff experience.

Users and technicians must be trained before operating the ULTIMA series washer.

All staff using the ULTIMA series washer should have received full user training. This training must include selecting and understanding the washing cycle, loading and unloading of the glassware and knowledge of the chemical products used.

Installation and maintenance must be carried out by staffs who have received training for this equipment.

3. PRODUCT & ADDITIVE LIABILITY

ULTIMA series washers must be used under normal operating conditions as indicated in this GETINGE LANCER user manual.

Failure to follow these recommendations including training could result in material damage or personal injury and will render null and void any warranty or liability on GETINGE LANCER part.

Liability will not be accepted in the event of incorrect use or modification of the washer without the prior agreement of the manufacturer.

4. SYMBOL

This manual contains extremely important warnings, instructions and notices, hence symbols have been used to draw your attention to them.



Safety warning for persons and equipment



Advice and recommendations

CHAPTER 3

ULTIMA series WASHERS

1. OPERATOR INTERFACES

1.1 CONTROL PANNEL

810LX / 815LX / 820 LX

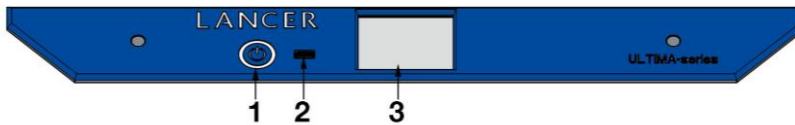

910LX / 1300LX

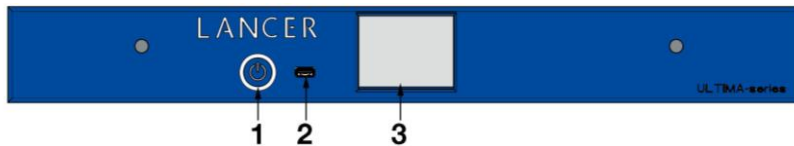

1400LX / 1400LXP / 1600LXP

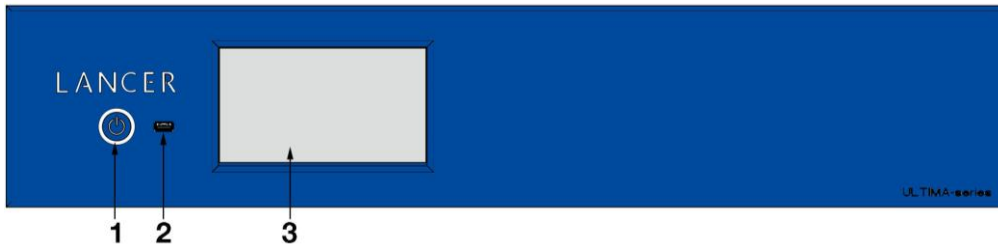

1800LXA

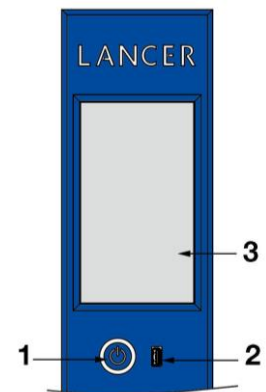

1	Button ON / OFF	2	USB Port
3	Touchscreen panel 3.5": 810LX/815LX/820LX/ 910LX/1300LX/1400LX 7": 1400LXP / 1600LXP / 1800LXA	4	Conductivitymeter (option-applicable on 1400LXP/1600LXP/1800LXA only)
5	Internal printer (option-applicable on 1400LXP/1600LXP / 1800LXA only)	6	External printer (option)
7	Emergency stop (Not proposed on 800 LX series et 910LX Option-applicable on 1300LX/1400LX/1400LXP/1600LXP Standard on 1800LXA)	8	Main switch (option-applicable on 1400LX/1400LXP/1600LXP/1800LXA only)

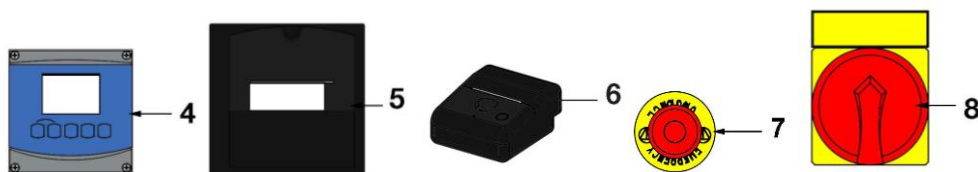

1.2 TOUCH SCREEN

Example of the 3.5" main screen for:
810LX/815LX/820LX/
910LX/1300LX/1400LX









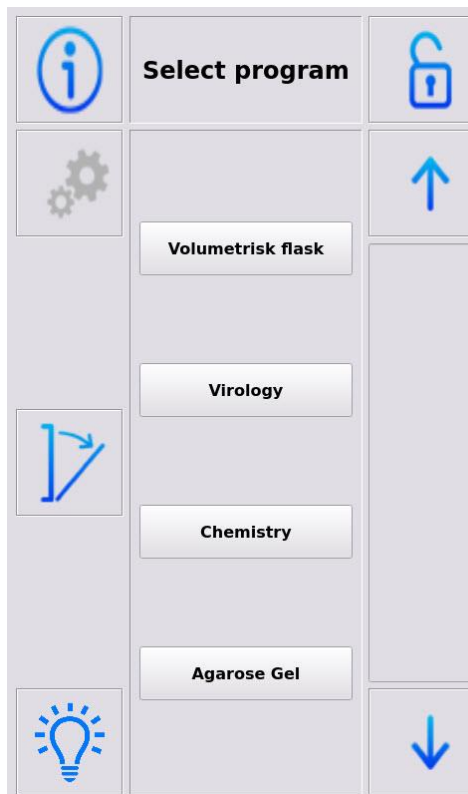

Example of the 7" main screen for:
1400 XLP / 1600 LXP





















































Example of the vertical 7" main screen for: 1800LXA



1.3 ICON LIST

	Login		Logout		Page Up
	Page Down		Information		System
	Door Open		Door Close		Light

	Back		Confirm		Close
	Documentation Program		Edit /create Program		Sampling
	Start		Abort/Stop		Clear Alarm
	Cycle Details		Alarm History		Export
	USB		Print		Reprint
	Copy		Date/Time		Language
	User Setup		Settings		Diagnostics
	Digital Inputs		Analog Inputs		Outputs
	Calibration		Manual Calibration		Automatic Calibration
	Pump Priming		Ticket Header		Ticket Footer
	Edit Users		Counters		Rename
	Common times		Temperature Settings		Security Settings
	Flow Meters		Pressure Transmitters		Conductivity
	Edit System		File Management		System Reset
	Equipment ID		Water Supplies		Chemical Supplies
	Sequence Names		Door Management		Display
	Download File		Upload File		Reboot System

1.4 ALPHANUMERIC KEYPAD



When you press on a modifiable parameter, an alphanumeric keypad opens.

On the upper left corner is indicated the minimum and maximal value of the modifiable parameter.

Press **abc**, **CAP** and **&123** to navigate between the 3 alphanumeric keypads.



1.5 BUTTON ON / OFF



This button enables / disables the HMI and the outputs of the card.

At any time, from the main screen, it's possible to put the screen in standby by pressing this button, a pop-up appears to ask for confirmation of this action.

To reactivate the screen, press the button.

1.6 EMERGENCY STOP BUTTON

IF APPLICABLE

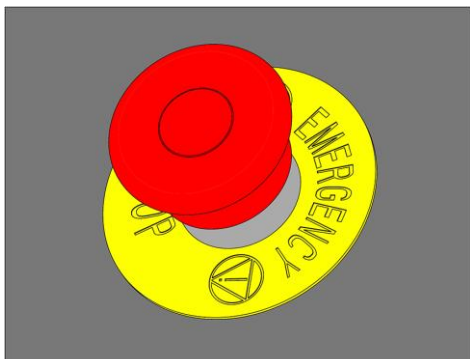

The button should be used in case of an emergency, press the emergency stop button to immediately stop the operation of the washer.

After actuating and before unlocking the emergency stop button, the washer must be inspected to determine the reason for the shutdown.

In order to reset the machine, turn the stop button red head clockwise or insert and turn the key (only for emergency stop button with key).



The key must only be in the emergency stop button for unlocking.

2. SAFETY ADVICES

This apparatus, dedicated to an industrial use, has been developed to wash and dry glassware, labware in the chemistry, microbiology, quality control and analytical laboratories ...



This washer must be used under the normal conditions of operation in conformity with the instructions manual of the manufacturer

We decline any responsibility and guarantee in the event of non-respect of these recommendations which can involve body or material damages

- Use only cleaning products designed for use in laboratory glassware washers.
- If you pretreat items to be cleaned with solvents or other cleaning agents, ensure that they have been purged from the items to be cleaned and allow potentially harmful or flammable fumes to dissipate before placing them in the apparatus.
- In the same way, it is strongly recommended not to use solvents or aerosols near the apparatus.
- If incidents occur and you cannot solve those using solutions that we recommend you, do not hesitate to contact GETINGE technical assistance service.

2.1 PRECAUTIONS FOR USE



AT THE END OF THE CYCLE, LET THE SUPPORTS, BASKETS, ACCESSORIES AND WASHED OBJECTS COOL BEFORE HANDLING THEM.

BURN RISK



PLEASE REFER TO PRODUCT MATERIAL SAFETY DATA SHEET IN CASE OF PRODUCT ACCIDENTALLY SPILLS OVER

2.2 SAFETY LABELLS



SAFETY GLASSES MANDATORY

SAFETY GLOVES MANDATORY

RISK FOR OPERATOR DEPENDS ON THE PRODUCTS (DETERGENTS AND ACIDS) USED INSIDE THE MACHINE AND ON THE NATURE OF DEPOSITS ON THE ITEMS TO BE CLEANED.



WEARING SAFETY GLASSES AND GLOVES MAY NOT BE SUFFICIENT IN SOME CASES.

OPERATOR HAS TO READ SAFETY DATA SHEETS OF USED PRODUCTS.

2.3 USE



IT IS STRICTLY FORBIDDEN TO USE THE WASHER IN AN EXPLOSIVE ENVIRONMENT OR TO USE SOLVENTS, HYDROCARBONS, NITRIC ACID, ALCOHOL, ALCOHOL DERIVATIVES, OR OTHER FLAMMABLE PRODUCTS IN THE MACHINE.

This machine uses detergent (caustic) and acid additives with elevated temperatures in the chamber during the different phases of the wash cycle. Opening the door during the wash cycle can cause EXPOSURE TO HIGH TEMPERATURES, HAZARDOUS CHEMICALS AND VAPORS.

2.4 MAXIMUM CHARGE

Respect the maximum charge allowed for the loading at the door and upper level.



DO NOT CLIMB OR SIT ON THE DOOR.

When several racks are used simultaneously on the different levels, only one rack should be pulled out of chamber on the door and the runners at a time.

Maximum charge permissible allowed (basket + items to be washed) on the different levels is :

	810-815	820 LX 910 LX	1300 LX	1400 LX 1400 LXP	1600 LXP	1800 LXA
Door area to avoid tilting	44 kg (97 lb) 52 kg (114 lb) (if plinth)	44 kg (97 lb) 52 kg (114 lb) (if plinth)	51 kg (112 lb)	65 kg (143 lb)	90 kg (198 lbs)	
First level in the chamber	26 kg (57 lb)	26 kg (57 lb)	26 kg (57 lb)	30 kg (66 lb)	30 kg (66 lb)	30 kg (66 lb)
Upper level in the chamber	23 kg (50 lb)	23 kg (50 lb)	23 kg (50 lb)	26 kg (57 lb)	26 kg (57 lb)	26 kg (57 lb)

Check that your basket may support the weight of your parts to be washed.

You should only use baskets that are suitable for the parts to be washed. When your washer is put into service, our technicians will give you useful advice on the best way to load the racks relative to the items to be washed.

It is possible to strengthen the baskets to your request, please feel free to contact GETINGE for advice or assistance.

3. OPENING OF THE DOOR

APPLICABLE FOR ALL ULTIMA MODELS EXCEPT 1800 LXA



Washer ON , press to unlock the door.

Use the door handle to open the door.

When washer is loaded and door closed, the washing cycle can begin.

The washer is equipped with a door locking device which prevents its opening during the washing cycle.

At the end of the cycle, if the temperature inside is over 60°C, the door remains locked.





DO NOT TRY TO FORCE TO OPEN THE DOOR DURING A WASHING CYCLE,
DOOR SAFETY LOCKING DEVICE CAN BE DAMAGED.



APPLICABLE FOR 1800 LXA ULTIMA MODELS

The washer is equipped with a door locking device which prevents its opening during the washing cycle.

When washer is loaded, washing cycle can begin.

Close the door with , select the cycle and press  to start the program.
At the end of the cycle, if the temperature inside is superior to 60°C, the door is locked.

When the chamber temperature is inferior to 60°C., press  to open the door

On standby, the door may be closed with  and opened with 



NEVER LEAVE THE PRODUCTS TANKS COMPARTMENT OPEN IF YOU MUST OPERATE THE DOOR.

4. WASHING PRODUCTS



PROGRAMS PREESTABLISHED WITH THIS WASHER HAVE BEEN VALIDATED WITH THE GETINGE LANCER BRAND WASHING PRODUCTS, the LLL DETERGENT AND THE NLL NEUTRALISANT.



THE INFORMATION CONCERNING THE SAFETY DATA OF THE GETINGE LANCER WASHING PRODUCTS HAS BEEN DELIVERED WITH WASHING PRODUCTS.

4.1 PRODUCT TANK AREA

(ONLY FOR WASHER EQUIPPED WITH A PRODUCT COMPARTMENT)



The washer is equipped with a product compartment (capacity 2 x 10L [2.5 gal] tanks) located on front of washer.

1800 LXA MODELS



ELECTRICAL DANGER / TAKE CARE OF YOUR HANDS

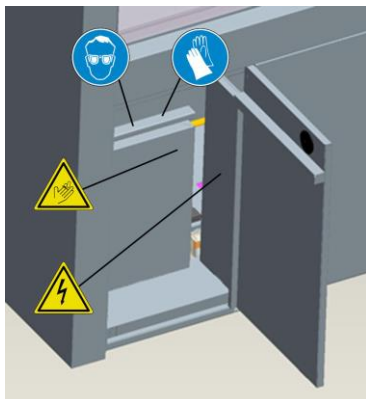

DO NOT INSERT YOUR HAND IN BETWEEN THE PRODUCT TANK COMPARTMENT AND THE HINGED DOOR WHICH ALLOWS ACCESS TO THE PRODUCT TANK COMPARTMENT.

DO NOT OPERATE THE DOOR IF THE PRODUCTS TANKS COMPARTMENT DOOR IS OPEN

4.2 WASHING PRODUCTS CATEGORIES

NON-FOAMING DETERGENT

Using the correct non-foaming detergent is required for proper cleaning in this machine. The non-foaming detergent must be matched to remove the contamination source in order to ensure satisfactory washing.

IT IS STRICTLY FORBIDDEN TO USE SOLVENTS AS DETERGENT.

PLEASE REFER TO SUPPLIERS MATERIAL SAFETY DATA SHEET FOR SPECIFIC SAFETY AND FORMULATION INFORMATION REGARDING THE DETERGENT USED IN THIS EQUIPMENT.

INCOMPATIBLE CHEMICAL LIQUIDS CAN HARM THE EQUIPMENT.

THE PROGRAMMED CYCLES ON THIS WASHER HAVE BEEN VALIDATED WITH GETINGE LANCER CHEMICALS, the LLL DETERGENT AND THE NLL NEUTRALISANT.

NEUTRALIZING ACID

Using the correct non-foaming neutralizing acid is required for proper cleaning in this machine. The non-foaming neutralizing acid must be matched to remove the detergent source in order to ensure satisfactory washing.

THE USE OF NITRIC ACID IS PROHIBITED. ONLY DILUTE PHOSPHORIC, ACETIC AND CITRIC ACIDS CAN BE USED.

PLEASE REFER TO SUPPLIER'S MATERIAL SAFETY DATA SHEET FOR SPECIFIC SAFETY AND FORMULATION INFORMATION REGARDING THE ACID USED IN THIS EQUIPMENT.

INCOMPATIBLE CHEMICAL LIQUIDS CAN HARM THE EQUIPMENT.

THE PROGRAMMED CYCLES ON THIS WASHER HAVE BEEN VALIDATED WITH GETINGE LANCER CHEMICALS, the LLL DETERGENT AND THE NLL NEUTRALISANT.

4.3 INSTRUCTIONS TO RESPECT IN CASE OF HANDLING THE WASHING PRODUCTS



ANYBODY CALLED TO HANDLE THE WASHING PRODUCTS MUST BE INFORMED OF THE RISKS ASSOCIATED WITH THESE PRODUCTS.

Before changing to a different type or brand of cleaning chemical (acid or detergent) it is necessary to purge the chemical line with water and rinse the plumbing circuitry of the machine.

Install the new chemical(s) per the installation instructions and then prime the detergent and acid pumps.

Then a wash cycle can be programmed and run which uses several rinses with water only. This will prevent any mixing of chemicals.

After the new cleaning chemical have been installed, it will be necessary to adjust the chemical dosing times in all applicable steps of the wash cycle in order to match the formulation of the new cleaning chemicals.

Please contact GETINGE for advice or assistance.

4.4 CHANGE OF THE TANKS

Before launching the cycle, check product tank levels and change those with low levels so as to avoid bad washing because of a lack of additive.

4.5 HOW TO CHANGE CHEMICAL CONTAINER

Switch the washer OFF.

Use the necessary protection for the chemical to be changed (gloves, mask, safety glasses...).

Locate the container(s) that need to be changed.

Unscrew the cap(s) from the empty chemical bottle(s) and take out the chemical suction tube(s).

Unscrew the cap(s) from the full chemical bottle(s) and insert the chemical suction tube(s). Tighten the cap(s) to secure the chemical suction tube in place.

Switch the washer ON.

Dispose of used chemical bottles or caps according to local and company regulations. Please consult the Material Safety Data Sheet for specific information regarding the chemicals used in the washer.

5. BUILT-IN PRINTER (IF APPLICABLE)

5.1 CHECKING THE PRINTER

Before launching any cycle or reprinting the printout, check the quantity of paper of the printer roller.

5.2 CHOICE OF THE SUITABLE PAPER ROLLS

It is recommended that a high quality thermal paper be used with a minimum of seven years life expectancy. The use of non-approved products can cause dust and increased wear. This can affect the warranty. The paper roll is delivered separately in order to prevent it from unrolling or becoming damaged during transport. Consult your GETINGE representative about suitable paper rolls.

5.3 REMOVING PAPER AND CLEARING PAPER JAMS

If there is some paper in the printer when a new roll is necessary or a paper jam has occurred, simply open the cover and press the paper advance button.

5.4 LOADING PAPER

- 1- Open the printer cover and press down the swinging support of the print mechanism at the point marked PUSH
- 2- Insert the end of the paper roll in the slit of the print mechanism and position the paper roll so that it rotates in the right direction, as shown in the figure
- 3- The paper is automatically pulled by the roller for 3 or 4 centimeters
- 4- Tear off the paper and re-close the cover

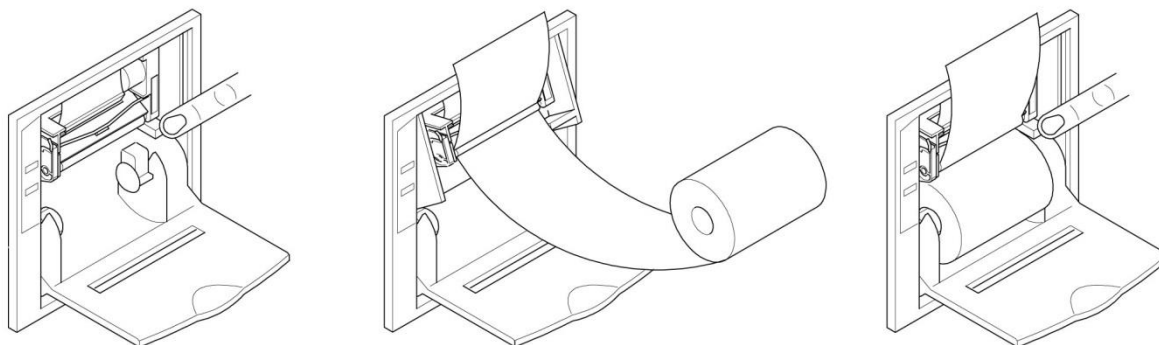

5.5 OPERATING MODES

Powering up is automatic or carried out by a command received from the washer.

5.6 PRINTER MAINTENANCE

After a certain time of use, it may prove necessary to remove paper dust from inside and around the mechanism. Use a small vacuum for cleaning.

For more information refer directly to the printer website.

6. EXTERNAL PRINTER (IF APPLICABLE)

6.1 CHECKING THE PRINTER

Before launching any cycle or reprinting the printout, check the quantity of paper of the printer roller.

6.2 CHOICE OF THE SUITABLE PAPER ROLLS

Please use quality paper. The use of non-approved products can cause dust and increased wear. This can affect the guarantee. The paper roll is normally delivered separately in order to prevent it from unrolling or becoming damaged during transport. Consult GETINGE about suitable paper rolls.

6.3 REMOVING PAPER AND CLEARING PAPER JAMS

If there is some paper in the printer when a new roll is necessary or a paper jam has occurred, simply open the cover and press the paper advance button.

6.4 LOADING PAPER

1. Slide the cover opening button forward until it opens.
2. Unroll a small amount of paper and insert the paper roll in the printer.
3. Close the cover, the paper has been loaded.

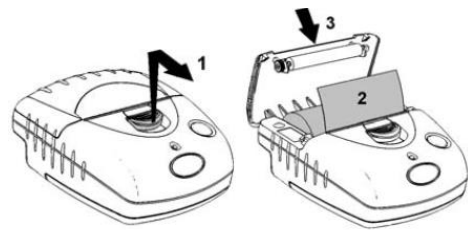

Pressing on the paper advance button while the printer is on standby mode makes the paper advance. However, the advance button has several other functions:

- ⇒ Pressing the button once and releasing it:
 - In standby mode, makes the paper advance.
 - In sleep mode, makes the printer go into the standby mode.
- ⇒ In standby mode, a “double click” on the button, prints out a sample message.

6.5 OPERATING MODES

“Stand-by mode”: ready to receive data but there is no data waiting to be printed out in the buffer and the printer engine is not turning.

“Sleep mode”: actually disabled. If the paper advance button is pressed, the external charger connected or external data is received, the printer leaves sleep mode and enters stand-by mode. The LED is off in sleep mode.

There is no switch. Powering up is automatic or carried out by a command received from the washer. To save energy, the printer enters sleep mode after a period of inactivity. The printer can be also programmed to always remain active or to enter sleep mode on command.

6.6 PRINTER MAINTENANCE

After a certain time of use, it may prove necessary to remove paper dust from inside and around the mechanism. Use a small vacuum for cleaning.

6.7 NOTE PRINTING

If the printer is connected to a battery pack and not an AC battery charger, it is imperative to control the operating mode (sleep mode / idle mode) of your printer prior to launch the printing.

In the washer HMI user menu, you can access to the reprinting cycles tickets and in the supervisor menu for printing:

- Program parameters
- Configuration settings.

If the printer is in sleep mode, the data launched from these menus will be lost.

It is imperative to enable the printer by pressing the paper feed button to launch printing.

If printing has been requested without idle mode setting of the printer, it may be necessary to power off and on again your washer and printer to reset them.

7. USING OF THE ACCESSORIES

7.1 SOME EXAMPLES

In order to wash items in "LTC" or "STC" type baskets, place the baskets on the "PST" (basic rack) or "PSBT" (basic rack with spray arm) after removing one or more "GS" (support grilles). Check that the basket is correctly fitted on the rods of the rack designed for that purpose. Reinstall the grids for any washing operation that does not require the use of "LTC" or "STC" type baskets.

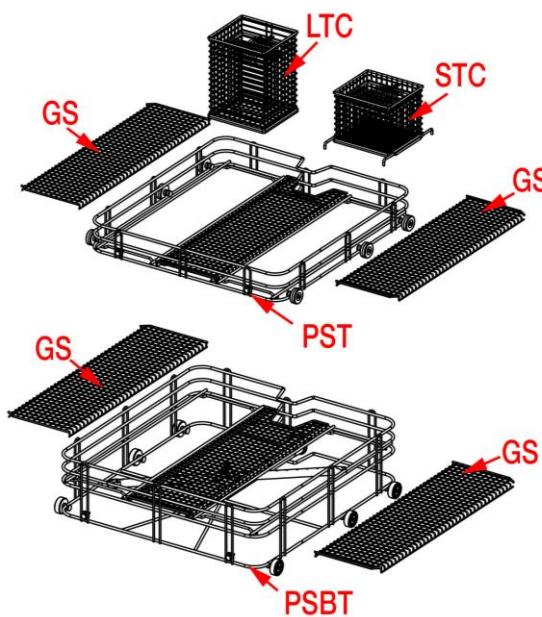

Note: The "PST" should only be positioned at the bottom level of the washer chamber where washing action is provided by the lower spray arm. The "PSBT" can be positioned on any level.

It is extremely important that the items to be washed are prevented from moving in order to obtain correct cleaning and to avoid breakage of fragile items. Items that can be easily moved or knocked over when loaded on the "PST" or "PSBT" rack should be secured in place. The "GC" hold down screen should be used for "PST" or "PSBT" racks. The "GCI" hold down screen should be used for injector racks.

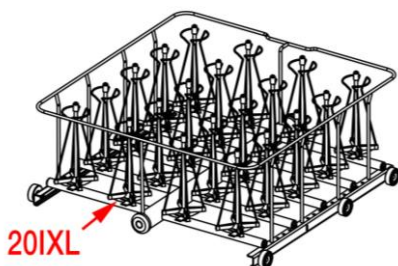
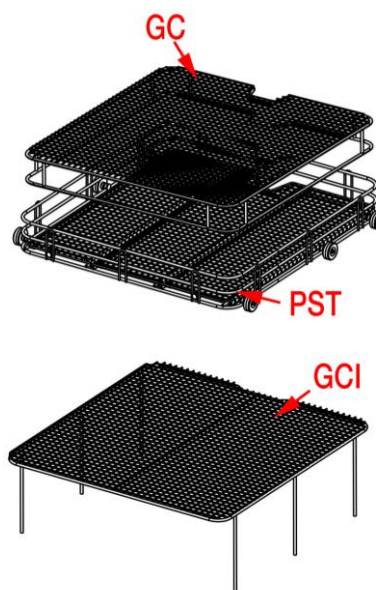

In the case of washing items with small diameter openings such as volumetric flasks, it is very important that the flow rate of the injectors used must be lower than the flow capacity of the flasks to be washed in order to avoid a gradual filling of the flasks during the washing cycle. If the diameter of the opening is too small to allow the water to escape from around the injector the mechanical action of the injector can be absorbed by the water contained in the glassware giving poor cleaning results. It is imperative to use baskets with injectors of proper diameter and, above all, to secure lightweight items with a "GC" or "GCI" hold down screen.

DETAIL ON BASKET INJECTOR:

- An adaptable stainless steel wire to maintain the glassware in position
It shall be used with narrow width mouth glassware and shall not under any circumstances exceed their flexibility by forcing glassware that is not intended to be placed in these.
- Just below the injector tip is a flat surface which allows a wrench to be used to remove the injector for maintenance
- An integrated spring clip allows the star base to be moved up or down to accommodate different heights of glassware

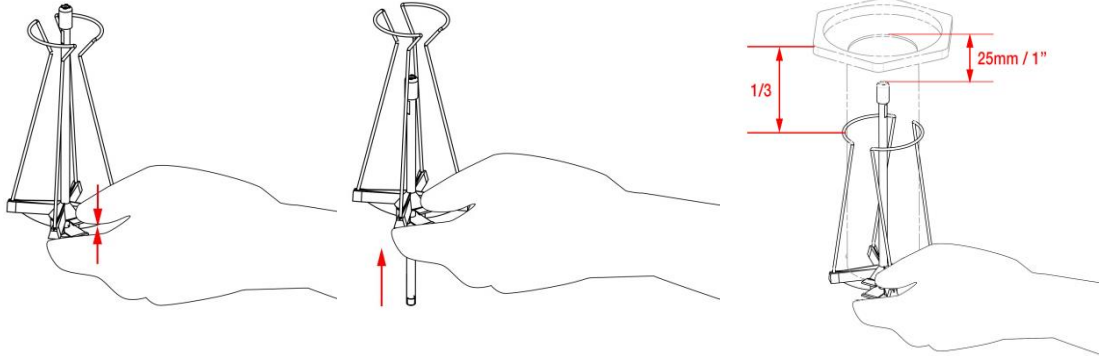

You should only use baskets that are suitable for the parts to be washed. When your washer is put into service, our technicians will give you useful advice on the best way to load the racks relative to the items to be washed.

Please feel free to contact GETINGE for advice or assistance.

When several racks are used simultaneously on the different levels, only one rack should be pulled out of chamber on the door and the runners at a time.



IF THE LOADED RACKS EXCEED 25 KG (55 LB) AN OPTIONAL TROLLEY CAN BE USED TO LOAD AND UNLOAD THE WASHER.

7.2 FITTING THE BASKETS

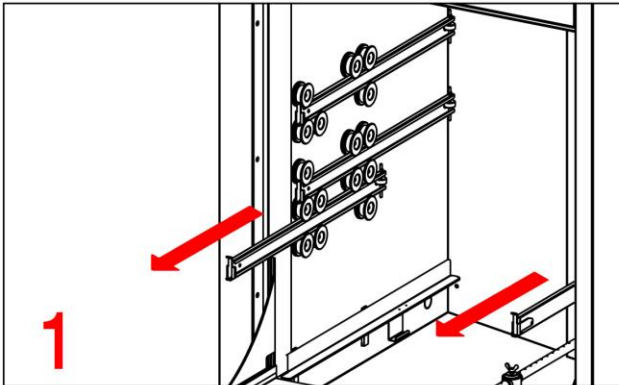

1 Pull the slide rails out of the chamber.

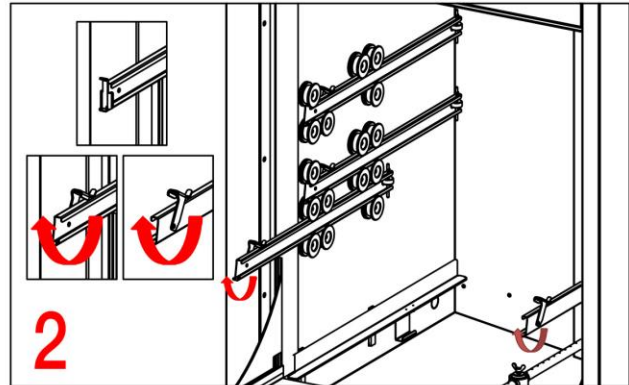

2 Open the locking device by rotating it up.

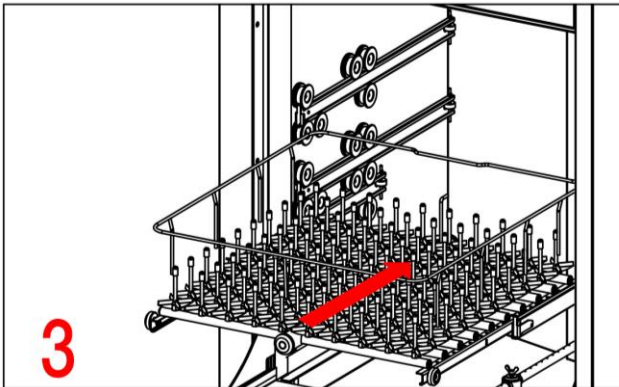

3 Insert back wheels of basket into rail slide and begin pushing basket into chamber.

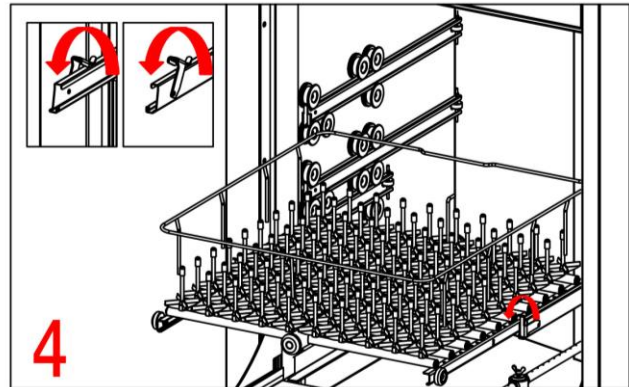

4 Once the middle wheels of basket have gone past the locking device, rotate it down to lock the basket in place.

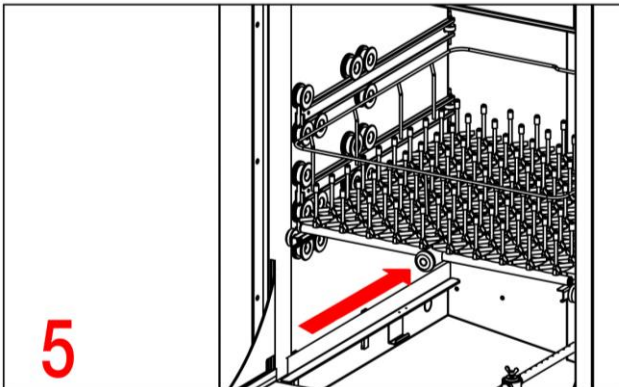

5 Push basket and rail slides all the way into the chamber.



THE CHOICE OF THE BASKETS AND RACKS IS VERY IMPORTANT TO EFFICIENT CLEANING.

PLEASE FEEL FREE TO CONTACT GETINGE FOR ADVICE OR ASSISTANCE.

1800 LXA MODELS

The rails, not positioned in the central rack, are locked inside the chamber using a spring lock.

Before fitting basket you must :

- Press the spring to release the rail.
- Relax the pressure once the rail is completely clear.

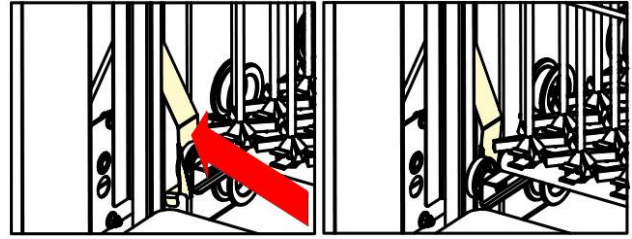

RISK OF FINGER PINCH.

And after use the procedure describe above to fitting basket



CHECK THAT ALL RAILS ARE IN THE RETRACTED POSITION BEFORE ANY DOOR MOVEMENT.

7.3 LOADING GLASSWARE



A MINIMUM CLEARANCE OF 25 MM (1 IN) IS REQUIRED BETWEEN THE END OF THE INJECTOR AND THE BASE OF THE GLASSWARE.

PLEASE FEEL FREE TO CONTACT GETINGE FOR ADVICE OR ASSISTANCE.

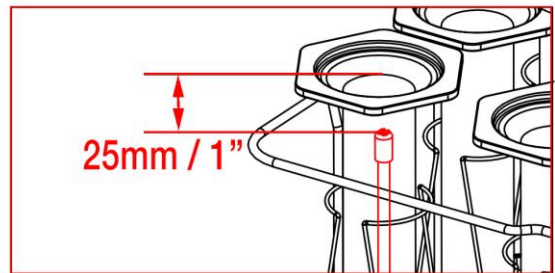
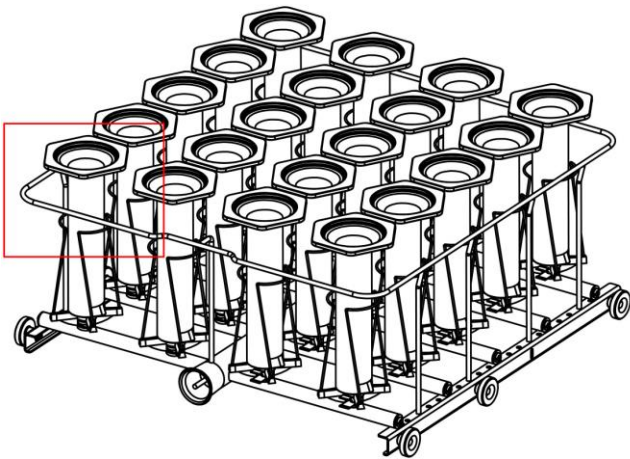

Some examples of loading glassware:



CHAPTER 4 WASHER UTILIZATION

1. FUNCTIONS ACCESS BY LEVEL CODE

FUNCTIONS	OPERATOR	TECHNICIAN	SUPERVISOR
Launching a cycle	<input checked="" type="checkbox"/>	<input checked="" type="checkbox"/>	<input checked="" type="checkbox"/>
Sampling during cycle	<input checked="" type="checkbox"/>	<input checked="" type="checkbox"/>	<input checked="" type="checkbox"/>
Reading washing programs	<input checked="" type="checkbox"/>	<input checked="" type="checkbox"/>	<input checked="" type="checkbox"/>
Dosing pumps priming	<input checked="" type="checkbox"/>	<input checked="" type="checkbox"/>	<input checked="" type="checkbox"/>
Edit programs			<input checked="" type="checkbox"/>
Ticket parameters	<input checked="" type="checkbox"/>	<input checked="" type="checkbox"/>	<input checked="" type="checkbox"/>
User setup	<input checked="" type="checkbox"/>	<input checked="" type="checkbox"/>	<input checked="" type="checkbox"/>
Date & time update		<input checked="" type="checkbox"/>	<input checked="" type="checkbox"/>
Calibration		<input checked="" type="checkbox"/>	<input checked="" type="checkbox"/>
Diagnostics (inputs/ outputs)		<input checked="" type="checkbox"/>	<input checked="" type="checkbox"/>
Display language			<input checked="" type="checkbox"/>
Settings			<input checked="" type="checkbox"/>

Please refer to the "ACCESS CODE" document for available access codes list by level and by security types.

2. CONNECTING TO THE MAINS



Press  button.

After a few seconds, the Initialization screen is displayed.

After the software is loaded, the main screen is shown.

3. ACCESSIBILITY TO THE WASHER

Depending on the configuration selected for your ULTIMA washer, cycle launching and accessibility settings could be different, regardless of your access level:

There are many types of security levels:

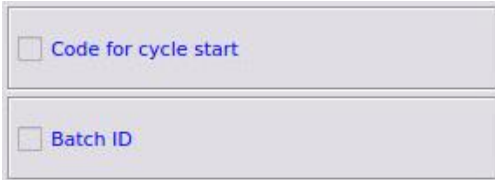

Code for cycle start : if selected, access code is required to start a wash cycle and access the different icons linked to it.

Batch ID : (or load information), if selected, you have to enter a batch ID or an information related to the load in process. Batch ID will be indicated on cycle printout (only if your washer is equipped with a printer) or indicated on the PDF report that you can retrieve via the USB support.

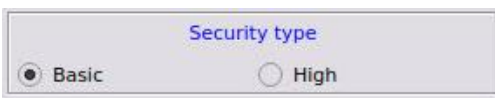

Basic Security type : if selected, you have to enter a password to access the washer settings but not to start a wash cycle.

High Security type : if selected, you have to enter a password and a user name to access the washer settings but not to start a wash cycle.

3.1 BASIC SECURITY (LEVEL 1)



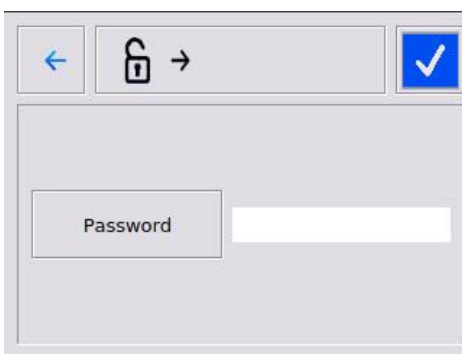

Press  to login to system.

If the system is configured for Basic Security, a numeric keypad will be shown for entering an access code.

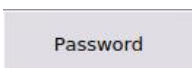

Press  to open the alphanumeric keypad.

Enter the password and press  to accept the entry and return to the login menu.

Once the information has been entered, press  to complete the login process.



Please refer to the "ACCESS CODE" document for available access codes list.



If these have been customized with , please refer to the document listing this new information

3.2 HIGH SECURITY (LEVEL 2)



Press  to login to system.

The login menu is shown.

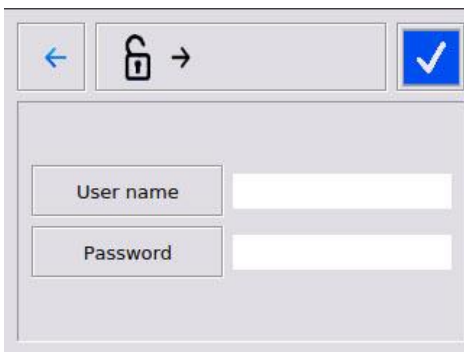

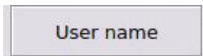
Press  to open the alphanumeric keypad.

The user name is entered and press , the login menu page is displayed again.

Enter the user's password and press .

Once both pieces of user's information have been entered,  is pressed to complete the login process.



Please refer to the "ACCESS CODE" document for available access codes list.



If these have been customized with , please refer to the document listing this new information

4. WASHER INFORMATION



In standby and during operation, Information about the washer (Alarm History and Washer information) are available.



Press  to open a menu where you can pick from Washer information or Alarm History (see page 55)



Press  allows to view information about the washer. Use the page up/down icons to scroll through information.

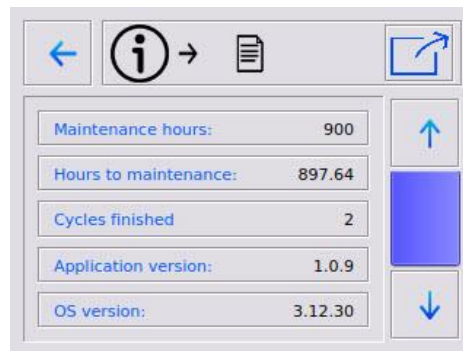
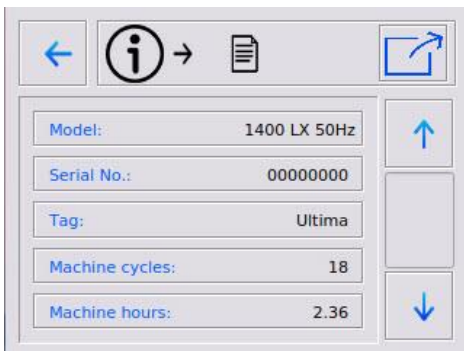

CHAPTER 5

LAUNCHING A CYCLE

1. CYCLES PRESENTATION

PROGRAMME 01: VOLUMETRIC FLASKS

- Prewash with the detergent
- Wash with the detergent.
- Acid rinse with the neutralizant acid
- Rinse with purified water
- Final rinse at 50°C with the purified water
- Drying (depending washer model)
- Cooling (depending washer model)

PROGRAMME 02: BACTERIOLOGY, VIROLOGY

- Prewash with the detergent
- Wash with the detergent.
- Acid rinse with the neutralizant acid
- Final rinse at 80°C with the purified water
- Drying (depending washer model)
- Cooling (depending washer model)

PROGRAMME 03: CHEMISTRY, BIOLOGY

- Prewash with the detergent
- Wash with the detergent.
- Acid rinse with the neutralizant acid
- Rinse with purified water
- Final rinse at 80°C with the purified water
- Drying (depending washer model)
- Cooling (depending washer model)

PROGRAMME 04: GELOSE

- Prewash with the detergent at 90°C
- Wash with the detergent.
- Acid rinse with the neutralizant acid
- Rinse with purified water
- Final rinse at 80°C with the purified water
- Drying (depending washer model)
- Cooling (depending washer model)

NOTE: other programs can be setup has needed.

2. LAUNCHING A CYCLE



From the main menu, the operator may scroll through the program list.

The last program used is highlighted with dark shading. (P01 in this example.)

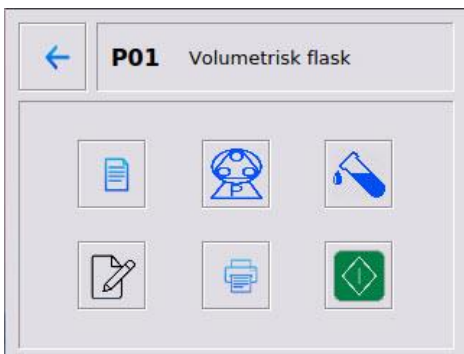

Once a program has been selected, the program function menu is displayed. In this menu, the functions related to wash programs can be selected (see different possibilities p37).



To start the program press

Nota : the door must be closed and locked for all washers except 1800LXA whose the door closes automatically

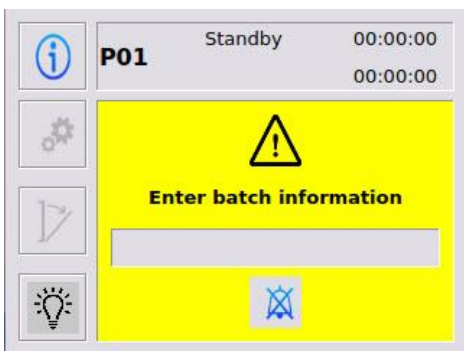

If your washer has been configured with the Batch ID option (refer to page 30), you are prompted to enter a batch information when you see this screen at start of cycle.

3. DURING THE CYCLE

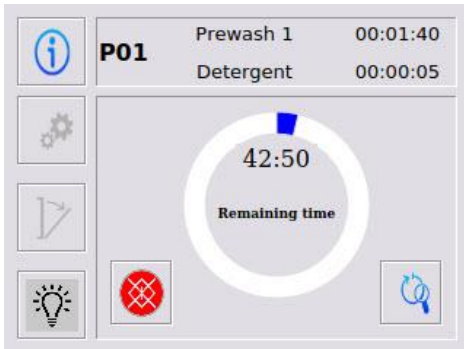

During normal wash cycle operation, the Circle progress bar is shown. Additional information (Program #, Sequence, Phase, Total Cycle Time, and Phase Time) is shown in the display header.

The wash cycle can be stopped / aborted by pressing .

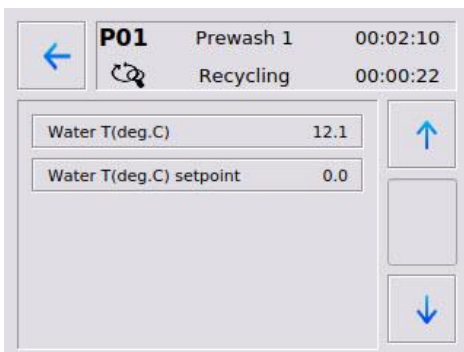

During the cycle, detailed information can be displayed.

Press  to display the detailed information.

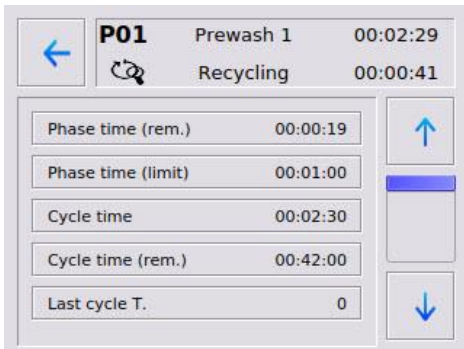

Press   to page up/down.

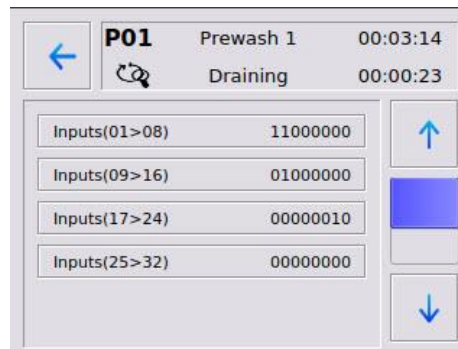
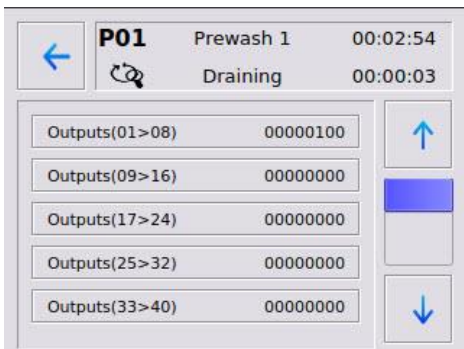

4. END OF CYCLE

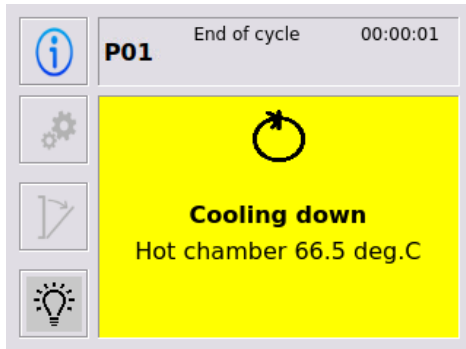

When the wash cycle is completed without incident, a screen indicates if the temperature is superior to 60°C or if the washer can be unloaded.

If the chamber interior temperature is equal or superior to 60°C, the screen opposite remain displayed until the temperature has passed below this value.

The acknowledgment of the cycle can only be done when the following screen appears

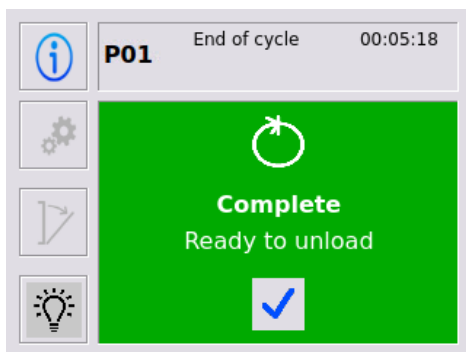

Press  to acknowledge the cycle and start the unlock of the door.

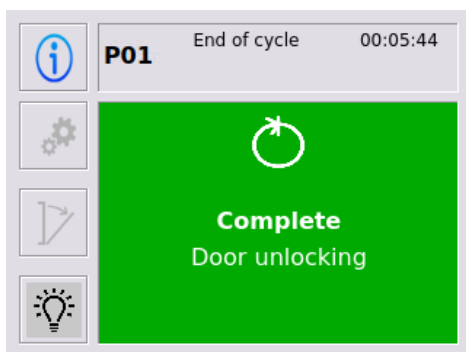

This screen indicates that the door unlocks, it is necessary to wait until the following screen appears before operating the handle.



For 1800LXA ,it's necessary to press  to unlocked the door.



CHECK THE CONDITION OF GLASSWARE WHEN UNLOADING ITEMS FROM THE WASH CHAMBER

CHAPTER 6

ACCESS TO THE USER

1. SAMPLING DURING THE CYCLE



Only for washer with sampling valve option

A sampling selection in the program stops the washer. Sampling the washer water allows to control the efficiency of the cycle and validate it.

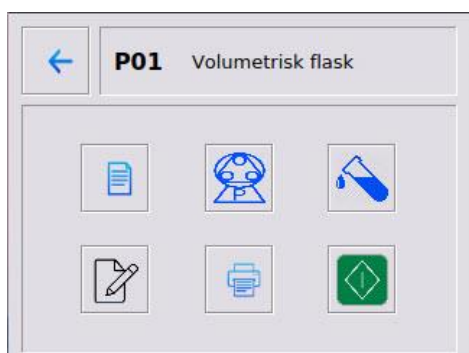

Once a program has been selected, the program function menu opens in which functions related to wash programs can be selected

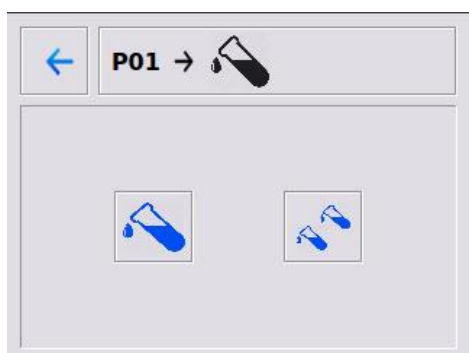

When  is pressed, the sampling menu opens



The operator can select to be taken during the cycle :

-  : one sample before the final rinse draining phase ("final rinse" sampling).
-  : multiple samples before each draining phase ("multi-phase" sampling)

After making the appropriate selection, the display returns to the program function menu.

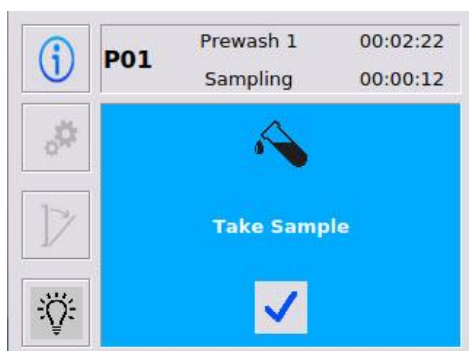

After the program is started, a sample confirmation message will appear during the cycle when it is time to take the sample.

Remove the sampling valve plug
Place a glassware under the sampling valve neck
Open the valve to take a sample.
Close the valve.
Put the plug back in place.

Once the sample has been taken, press  to allow the cycle to continue.



2. READING WASHING PROGRAMS

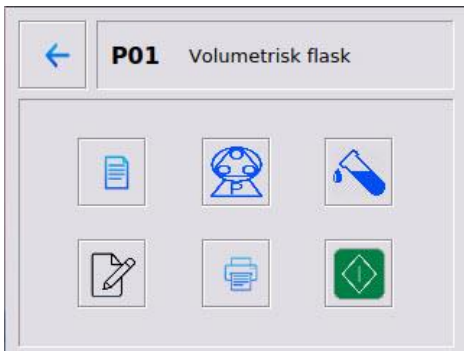

Selecting a program from main menu (P01 in this example) will open a menu in which you can perform different functions related to program cycles.



Pressing  will allow you to view the program setup for the current cycle.

Use  /  to scroll through the information (Note, there are 14 menu pages of information related to Program cycles).

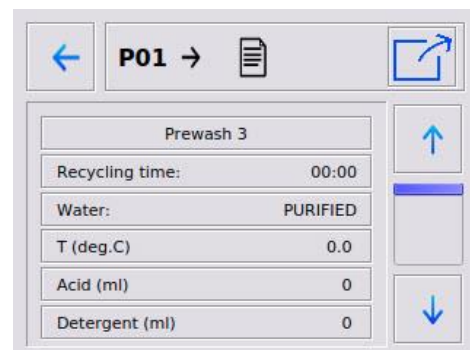
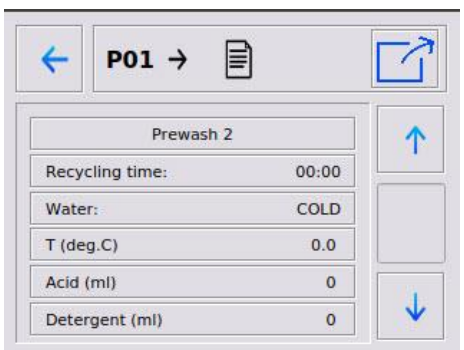
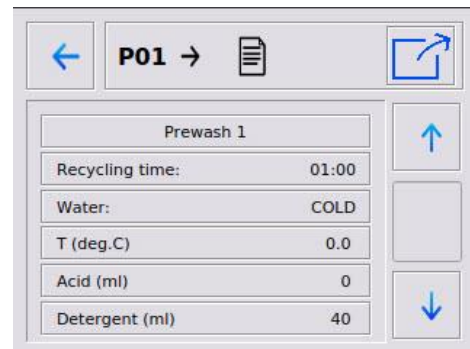
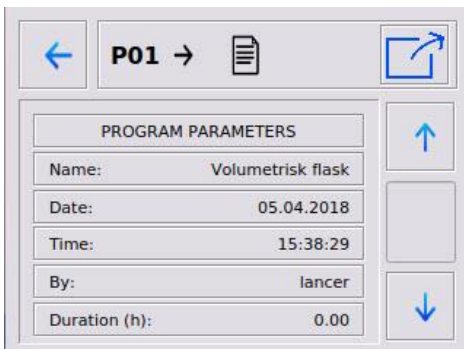

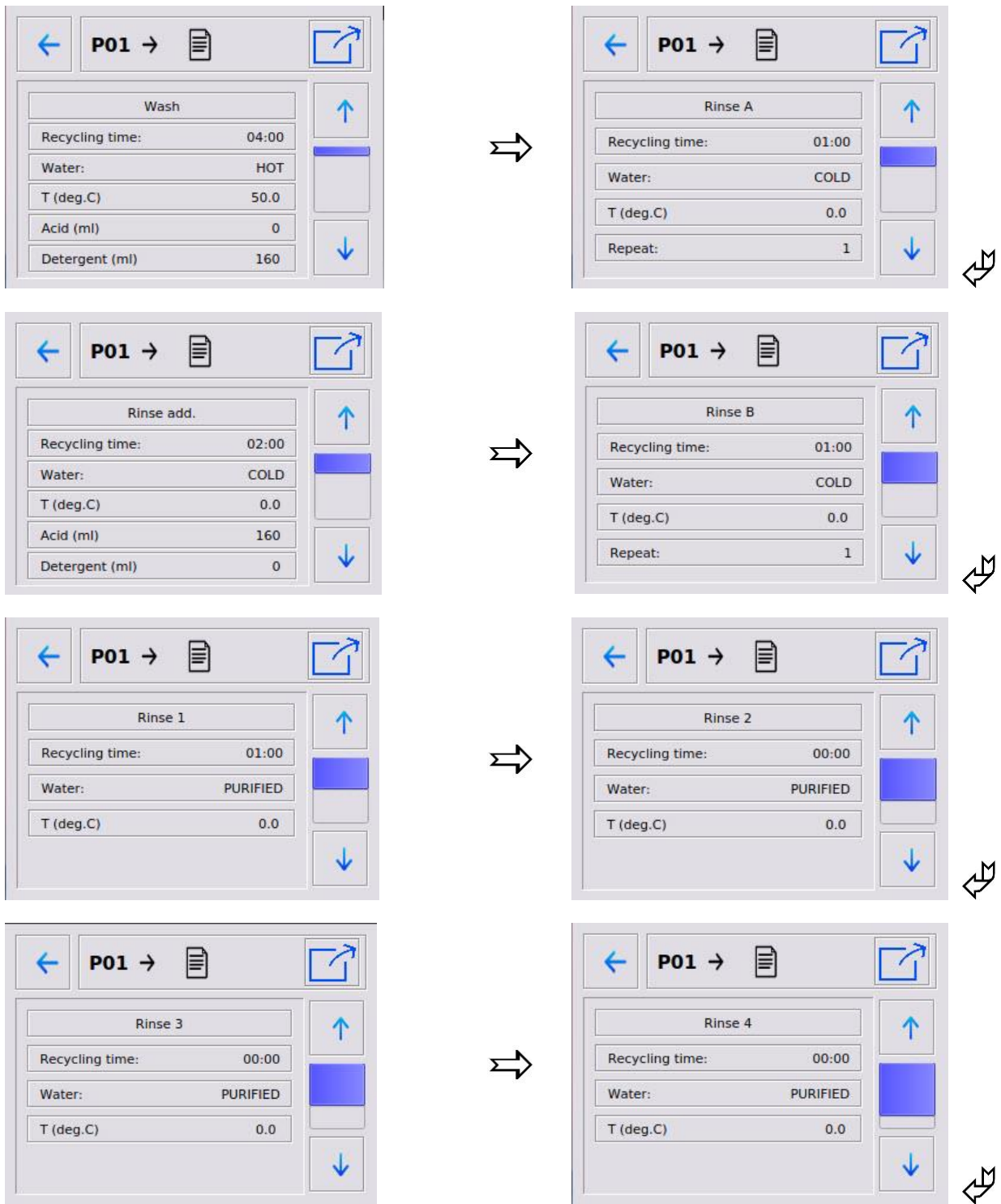

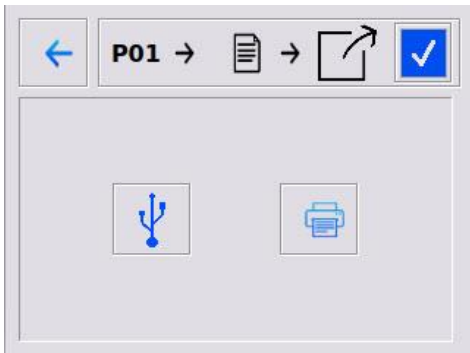
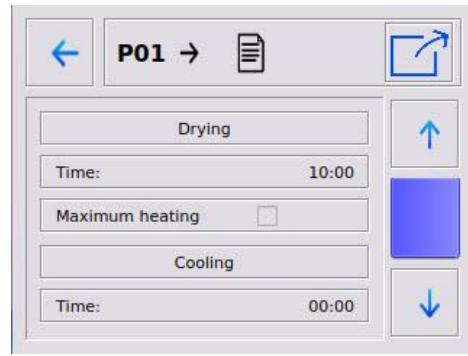
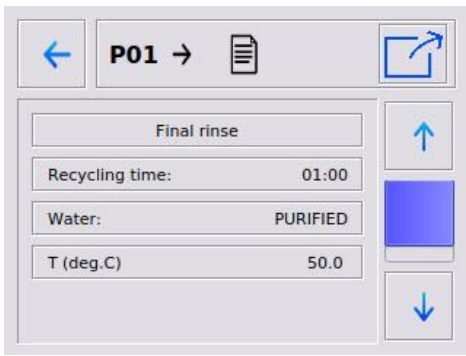

At any point you can press  to send the program cycle data to USB store device or printer

(If the printer option is not fitted on washer, the printer icon will be shown in grey to indicate that it is not active.)

3. ADDITIVE PUMP PRIMING

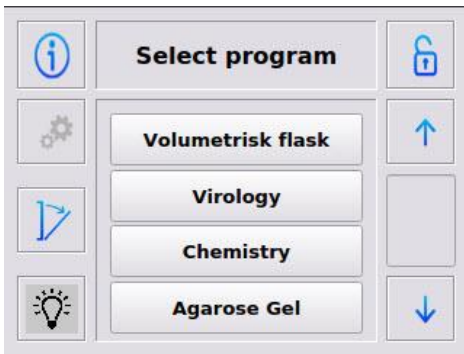

Selecting a program from main menu will open a menu in which you can perform different functions related to program cycles.

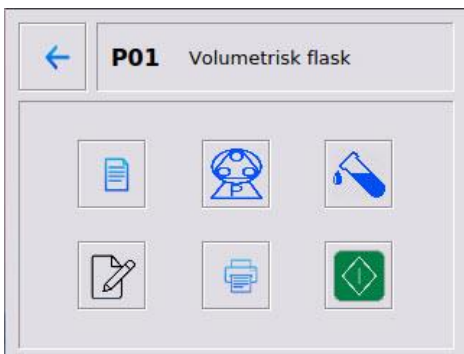

Pressing  will allow you to select and then prime a chemical pump.

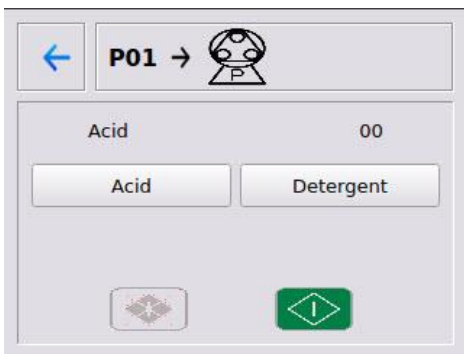

Select the desired chemical pump.

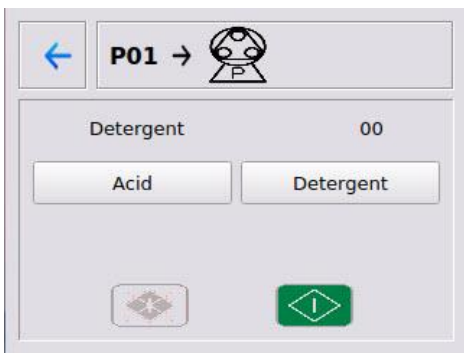

Once you press , the pump will run for 60 seconds.

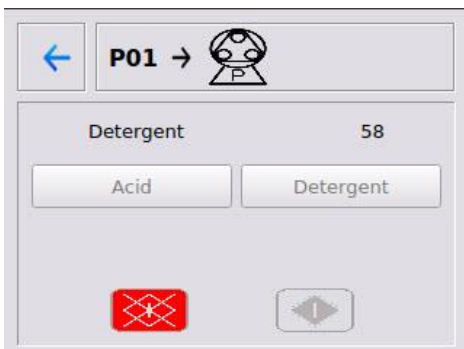



 can be pressed at any time during the 60 seconds to stop the pump. After the pump stops, the chamber will be filled with cold water for 30 seconds to help flush away residual chemical and then the drain circuit will be energized for 30 seconds to send the solution to drain.

4. TICKET PARAMETERS

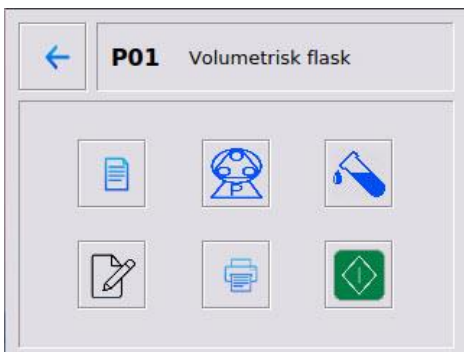

Selecting a program from main menu will open a menu in which you can perform different functions related to program cycles.



Pressing  will open a menu in which you can to select and edit ticket header and footer information and also reprint previous cycle tickets.

4.1 TICKET HEADER

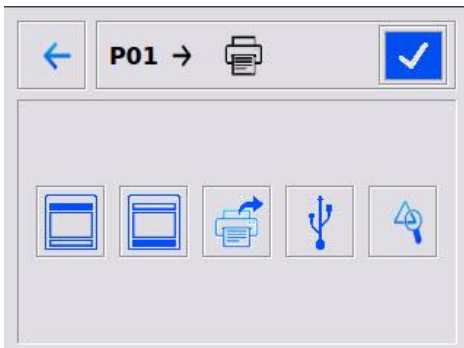

Press  to display the header menu.

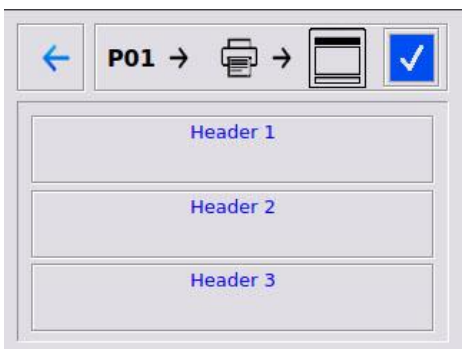



Press the applicable Header 1, 2 or 3 icon to open the alphanumeric keypad and enter desired header text.

Press  to confirm text entry and to close the alphanumeric keypad.

At the header menu, press  to save the updated header information

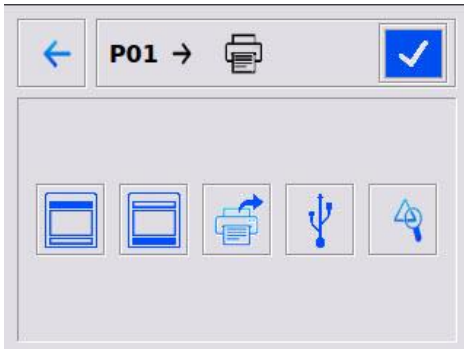
4.2 TICKET FOOTER



Press  to display the footer menu.

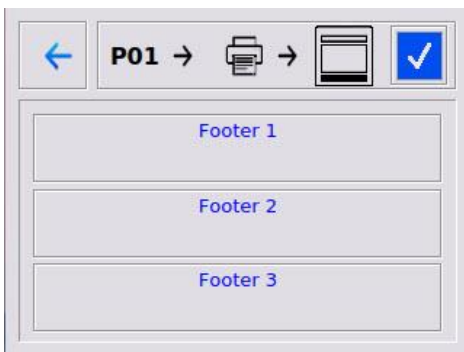

Press the applicable Footer 1, 2, or 3 icon to open the alphanumeric keypad.

Press  to confirm text entry and to close the alphanumeric keypad.

At the footer menu, press  to save the updated footer information

4.3 REPRINTING TICKETS

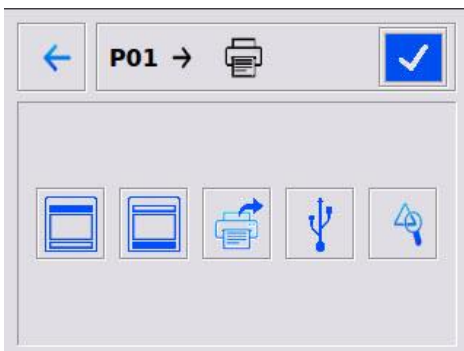

Press  to open the reprint menu and reprint previous tickets.

(Note, if the printer option is not fitted on washer, the printer icon will be shown in grey to indicate that it is not active.)

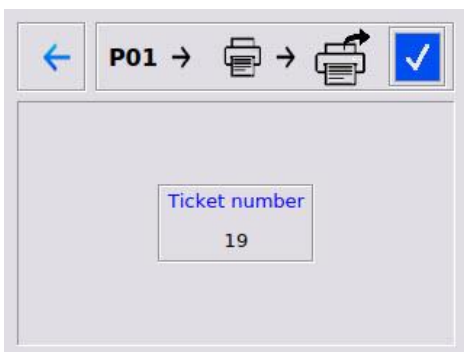

Pressing on the **Ticket Number** icon will open a numeric keypad so that you can select the ticket number to reprint

Press  to confirm the selection and to close the keypad.

At the reprint menu, press  to resend the selected ticket to the printer.

Please refer to the traceability chapter page 49 to see an example of ticket.

4.4 EXPORT TICKET ON USB KEY

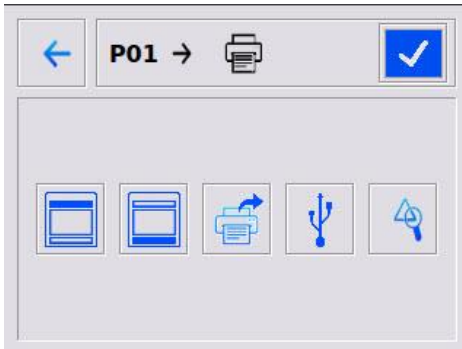

Press  to open the exportation menu, then PDF wash cycles stored on main board can be exported on USB support.

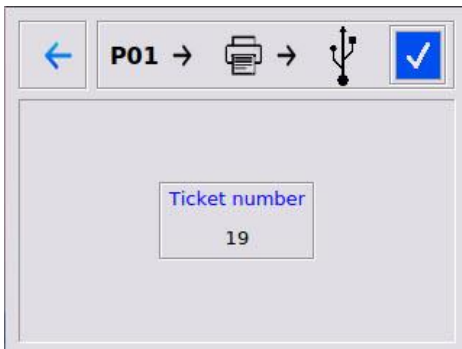

Pressing on the **Ticket Number** icon will open a numeric keypad so that you can select the ticket number to export.

Two possibilities :

- If « ticket number » = 0, then all the stored files are exported on the USB key
- If « ticket number » ≠ 0 (last cycle number or number of any other cycle you wish to export), then only the file corresponding to the number is exported on the USB key

Press  to confirm the selection and to close the keypad.

At the export menu, press  to send the selected ticket to the USB key.

Please refer to the traceability chapter page 49 to see an example of ticket.

4.1 VISUALIZATION OF CYCLES TICKETS

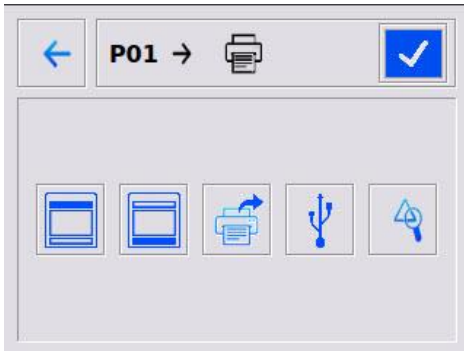

Press  to open the visualization menu and view previous tickets

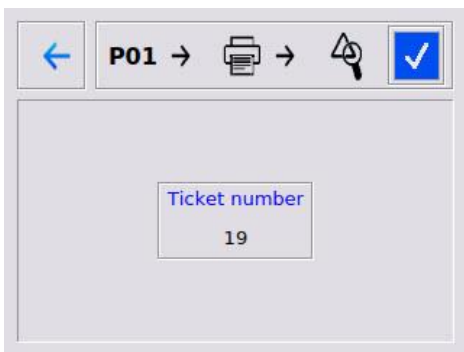

Pressing on the **Ticket Number** icon will open a numeric keypad so that you can select the ticket number to view.

Press  to confirm the selection and to close the keypad.

At the visualization menu, press  to view the selected ticket.

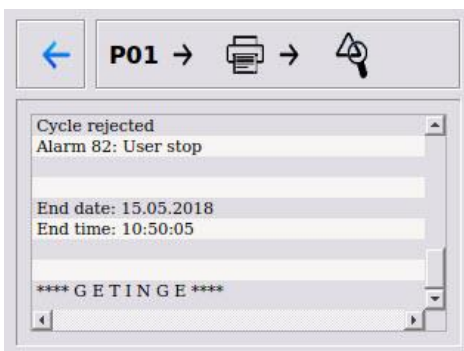
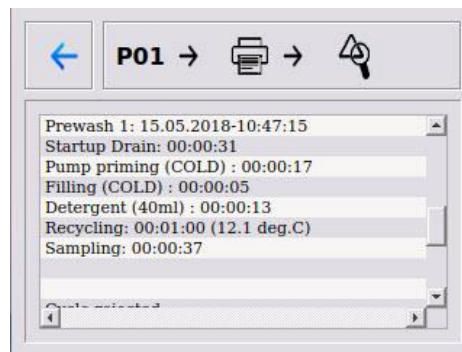
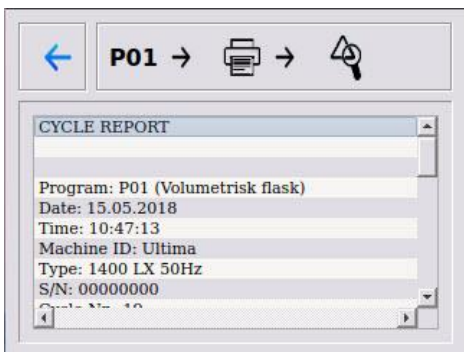

5. USER SETUP



Pressing  will open the system menu and allow you to edit system parameters

(Note, this is a restricted menu and if the operator is not already logged in they will be required to enter an access code or user name/password depending upon the defined security level.)





Pressing  will allow an operator to change their user name and password.

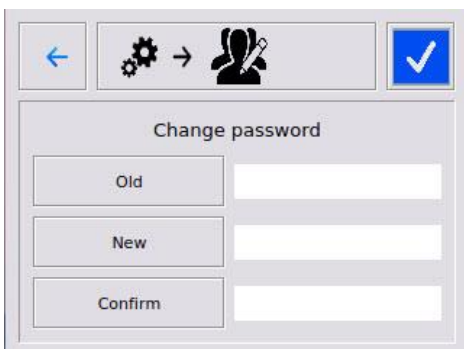

Each user can change his own user name and password.



Press .
Enter with the alphanumeric keypad your OLD password, then enter the NEW password and confirm it.

Press on  to confirm any changes and return to the System menu.

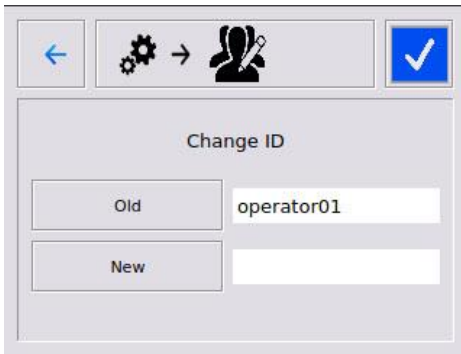

Change ID

Old operator01

New

Press **Change ID**
Enter with the alphanumeric keypad your OLD ID, then enter the NEW ID .

Press  to confirm any changes and return to the System menu.



It's advisable to have a document with a listing of user and access code associated.

CHAPTER 7

TRACEABILITY

1. MACHINE TRACEABILITY DOCUMENT

When starting the ULTIMA series washer, a “machine traceability” document should be created to index the various operations carried out on the washer (in parallel to the traceability already in use at facility).

This document, in conjunction with the facility's traceability procedure, should consist of archiving of printouts issued by the washer and recording of maintenance operations (corrective and preventive).



REGARDLESS OF THE RESULTS OF THE PROCESSED CYCLE, YOU MUST REVIEW THE WASHER PRINTOUTS BEFORE ARCHIVING THEM



GETINGE LANCER recommends to photocopy or scan the processing cycle printouts.



Only the last 200 wash cycles are stored in the washer's memory

Be sure to collect the data periodically.

Access and handling of this Electronic Record has to be managed by a Customer's SOP (Site Operation Procedure).

2. VIA SUPPORT USB

To guarantee the documented evidence of the wash cycle, the information can be retrieved in PDF format via a USB key from the USB port on the front of the washer. The PDF wash cycle report includes cycle parameters, operator number, time of program start, phase duration, probe temperature during each phase, detergent and acid intake.

EXAMPLE OF TICKET

CYCLE REPORT

Program: P04 (Agarose Gel)
Date: 11.02.2019
Time: 10:19:53
Machine ID: Ultima
Type: 820 LX 60Hz
S/N: 9X014577
Cycle Nr.: 4
Started by: guest

Prewash 1: 11.02.2019-10:19:55
Locking: 00:00:05
Startup Drain: 00:00:01
Pump priming (SOFT HOT) : 00:00:20
Filling (SOFT HOT) : 00:01:20
Detergent (96ml) : 00:00:31
Heating (SP=90.0deg.C): 00:12:31
Recycling: 00:02:01 (90.2 deg.C)
Draining: 00:01:18

Prewash 2: 11.02.2019-10:38:08
Pump priming (SOFT COLD) : 00:00:19
Filling (SOFT COLD) : 00:00:38
Recycling: 00:01:01 (71.6 deg.C)
Draining: 00:01:18

Wash: 11.02.2019-10:41:31
Pump priming (SOFT HOT) : 00:00:19
Filling (SOFT HOT) : 00:01:20
Detergent (120ml) : 00:00:37
Heating (SP=90.0deg.C): 00:09:43
Recycling: 00:02:01 (90.3 deg.C)
Draining: 00:01:18

Rinse A: 11.02.2019-10:56:58
Pump priming (COLD) : 00:00:19
Filling (COLD) : 00:00:45
Recycling: 00:01:01 (60.1 deg.C)
Draining: 00:01:17
Pump priming (COLD) : 00:00:20
Filling (COLD) : 00:00:43
Recycling: 00:01:01 (47.0 deg.C)
Draining: 00:01:16

Additive Rinse: 11.02.2019-11:03:52
Pump priming (COLD) : 00:00:19
Filling (COLD) : 00:00:38
Acid (96ml) : 00:00:36
Recycling: 00:02:01 (37.8 deg.C)
Draining: 00:01:17

Rinse B: 11.02.2019-11:08:51
Pump priming (COLD) : 00:00:19
Filling (COLD) : 00:00:44
Recycling: 00:01:01 (31.8 deg.C)
Draining: 00:01:17

Rinse 1: 11.02.2019-11:12:19
Pump priming (PURIFIED) : 00:00:19
Filling (PURIFIED) : 00:00:43
Recycling: 00:01:01 (27.6 deg.C)
Draining: 00:01:18

Final Rinse: 11.02.2019-11:15:47
Pump priming (PURIFIED) : 00:00:19
Filling (PURIFIED) : 00:00:43
Heating (SP=80.0deg.C): 00:14:59
Recycling: 00:01:01 (80.4 deg.C)
Draining: 00:01:19
Condenser: 00:05:00

Drying: 11.02.2019-11:39:16
Draining: 00:00:30
Drying: 00:24:59

Cooling: 11.02.2019-12:04:49
Cooling: 00:05:00

Cycle completed successfully

End date: 11.02.2019
End time: 12:09:53

*** GETINGE ***

1

3. PRINTER (IF APPLICABLE)

To ensure cycle documentation, information can be printed on a printer. The printout gives documented evidence of the cleaning process including cycle parameters, operator number, time of program start, phase duration, probe temperature during each phase, detergent and acid intake.

EXAMPLE OF TICKET

<p>CYCLE REPORT</p> <p>Program: P04 (Agarose Gel) Date: 02.25.2019 Time: 10:02:43 Machine ID: Ultima Type: 910 LX 60Hz S/N: 88127957 Cycle Nr.: 4 Started by: guest</p> <p>Prewash 1: 02.25.2019-10:02:45 Locking: 00:00:06 Startup Drain: 00:00:01 Pump priming (SOFT HOT) : 00:01:00 Filling (SOFT HOT) : 00:00:01 Detergent (104ml) : 00:00:30 Heating (SP=90,0deg.C) : 00:08:45 Recycling: 00:02:01 (90.7 deg.C) Draining: 00:01:21</p> <p>Prewash 2: 02.25.2019-10:16:37 Pump priming (SOFT COLD) : 00:00:59 Filling (SOFT COLD) : 00:00:05 Recycling: 00:01:01 (39.2 deg.C) Draining: 00:01:19</p> <p>Wash: 02.25.2019-10:20:08 Pump priming (SOFT HOT) : 00:00:59 Filling (SOFT HOT) : 00:00:01 Detergent (130ml) : 00:00:37 Heating (SP=90,0deg.C) : 00:08:13 Recycling: 00:02:00 (90.6 deg.C) Regeneration: 00:00:17 Draining: 00:01:03</p>	<p>Rinse A: 02.25.2019-10:33:28 Pump priming (COLD) : 00:00:59 Filling (COLD) : 00:00:05 Recycling: 00:01:01 (35.4 deg.C) Draining: 00:01:18 Pump priming (COLD) : 00:01:00 Filling (COLD) : 00:00:05 Recycling: 00:01:01 (20.8 deg.C) Draining: 00:01:18</p> <p>Additive Rinse: 02.25.2019-10:40:27 Pump priming (COLD) : 00:00:59 Acid (104ml) : 00:00:36 Recycling: 00:02:01 (17.7 deg.C) Draining: 00:01:19</p> <p>Rinse B: 02.25.2019-10:45:30 Pump priming (COLD) : 00:00:59 Filling (COLD) : 00:00:05 Recycling: 00:01:01 (14.9 deg.C) Draining: 00:01:19</p> <p>Rinse I: 02.25.2019-10:49:01 Pump priming (PURIFIED) : 00:00:59 Filling (PURIFIED) : 00:00:05 Recycling: 00:01:01 (55.8 deg.C) Draining: 00:01:17</p>	<p>Final Rinse: 02.25.2019-10:52:30 Pump priming (PURIFIED) : 00:00:59 Filling (PURIFIED) : 00:00:05 Heating (SP=80,0deg.C) : 00:05:04 Recycling: 00:01:01 (80.6 deg.C) Draining: 00:01:19</p> <p>Drying: 02.25.2019-11:01:05 Draining: 00:00:30 Drying: 00:24:59</p> <p>Cooling: 02.25.2019-11:26:38 Cooling: 00:05:00</p> <p>Cycle completed successfully</p> <p>End date: 02.25.2019 End time: 11:31:41</p> <p>**** G E T I N G E ****</p>
--	---	--

4. THE PRO KIT (IF APPLICABLE)

(OPTION ONLY FOR 810-815-820-910-1300-1400 LX MODELS)

The PRO KIT tracks a number of parameters and prints out their status OK/NOK or values at the end of the cycle for the customer's records and attention.

It is an easy and efficient method of quick analysis of the report.

PRO KIT 1 LX includes:

Printer, printout gives documented evidence of the cleaning process.

Water temperature, the water temperature is measured, both the preset and measured values are printed out.

Recirculation pump pressure, a pressure sensor will measure and print out the value. If the value is higher than the set value an alarm will be raised and the machine will stop the process.

Detergent / Acid flow rate, both lines are individually fitted with a flow meter. The device will print out the flow of each line.

PRO KIT 2 LX includes:

All PRO KIT 1 features and checks the quality of the wash process by measuring the conductivity of the final rinse water.

The obtained value is printed out. If the value is higher than the set value an alarm will be raised and the machine will stop the process.

EXAMPLE OF TICKET

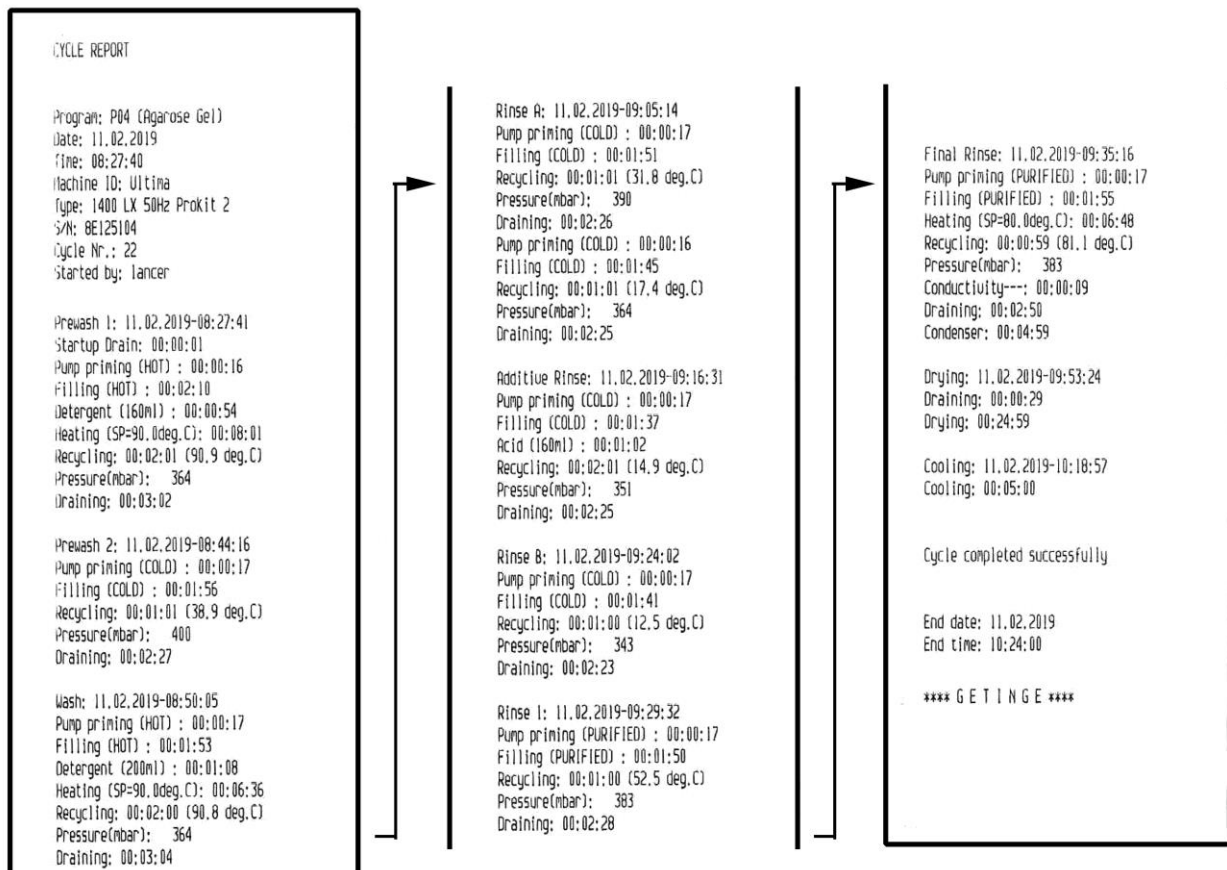

5. VALIDATION MONITOR, PRINTER (IF APPLICABLE) (OPTION ONLY FOR 1400-1600LXP -1800LXA MODELS)

The validation monitor has its own probes to check and validate every parameter of the cycle of the washing cycle.

The validation monitor option includes:

- One built-in panel printer
- One pressure transmitter for verification of proper functioning of the recirculating pump
- Two flow-meters measure the exact quantity of chemical taken by the machine during the cycle
- One water level pressurestat for verification of proper filling of the sump
- Two dual temperature probes for verification of proper temperature values
- One electrical link (two on 1800LXA) to the heating system for verification of proper temperature inside the chamber
- One electrical link (two on 1800LXA) to the draining system for verification of proper water exhaust between two wash cycle phases

EXAMPLE OF TICKET

<p>CYCLE REPORT</p> <p>Program: P04 (Agarose Gel) Date: 06.02.2019 Time: 14:56:33 Machine ID: Ullina Type: 1600 LXP 50Hz NonVal S/N: 86124211 Cycle Nr.: 67 Started by: guest</p> <p>Prewash 1: 06.02.2019-14:56:35 StartUp Drain: 00:00:01 Pump priming (HOT) : 00:00:16 Filling (HOT) : 00:00:37 Detergent (240ml) : 00:01:16 Heating (SP=90.0deg.C): 00:05:05 Recycling: 00:02:01 (91.4 deg.C) (MonVal 90.0 mbar) Pressure(mbar): 646 Draining: 00:02:04</p> <p>Prewash 2: 06.02.2019-15:08:04 Pump priming (COLD) : 00:00:17 Filling (COLD) : 00:00:50 Recycling: 00:01:01 (36.4 deg.C) (MonVal 36.4 mbar) Pressure(mbar): 669 Draining: 00:02:04</p> <p>Wash: 06.02.2019-15:12:24 Pump priming (HOT) : 00:00:17 Filling (HOT) : 00:00:46 Detergent (300ml) : 00:01:35 Heating (SP=90.0deg.C): 00:06:05 Recycling: 00:02:01 (91.5 deg.C) (MonVal 89.1 mbar) Pressure(mbar): 662 Draining: 00:02:07</p>	<p>Rinse A: 06.02.2019-15:25:25 Pump priming (COLD) : 00:00:17 Filling (COLD) : 00:00:50 Recycling: 00:01:00 (36.1 deg.C) (MonVal 36.2 mbar) Pressure(mbar): 715 Draining: 00:02:04 Pump priming (COLD) : 00:00:16 Filling (COLD) : 00:00:50 Recycling: 00:01:00 (20.4 deg.C) (MonVal 20.3 mbar) Pressure(mbar): 731 Draining: 00:02:07</p> <p>Additive Rinse: 06.02.2019-15:34:06 Pump priming (COLD) : 00:00:17 Filling (COLD) : 00:00:45 Acid (240ml) : 00:01:27 Recycling: 00:02:01 (18.1 deg.C) (MonVal 18.1 mbar) Pressure(mbar): 692 Draining: 00:02:05</p> <p>Rinse B: 06.02.2019-15:40:50 Pump priming (COLD) : 00:00:17 Filling (COLD) : 00:00:51 Recycling: 00:01:01 (14.3 deg.C) (MonVal 14.4 mbar) Pressure(mbar): 762 Draining: 00:02:07</p> <p>Rinse 1: 06.02.2019-15:45:14 Pump priming (PURIFIED) : 00:00:17 Filling (PURIFIED) : 00:01:46 Recycling: 00:01:00 (14.0 deg.C) (MonVal 14.0 mbar) Pressure(mbar): 752 Draining: 00:02:05</p>	<p>Final Rinse: 06.02.2019-15:50:31 Pump priming (PURIFIED) : 00:00:17 Filling (PURIFIED) : 00:01:44 Heating (SP=80.0deg.C): 00:05:06 Recycling: 00:00:59 (81.3 deg.C) (MonVal 80.7 mbar) Pressure(mbar): 631 Conductivity---: 00:00:11 Draining: 00:01:53</p> <p>Drying: 06.02.2019-16:00:54 Draining: 00:00:30 Drying: 00:24:59 (90.0 deg.C) Air temp (deg.C): 90 Air temp. MonVal. (deg.C): 90</p> <p>Cooling: 06.02.2019-16:26:27 Cooling: 00:05:00</p> <p style="text-align: center;">Cycle completed successfully</p> <p>End date: 06.02.2019 End line: 16:31:30</p> <p style="text-align: center;">**** GET IN GE ****</p>
---	---	---

CHAPTER 8

ALARMS

1. INCIDENTS

INCIDENTS	SOLUTION / VERIFICATION
The detergent or neutralizing agent does not enter in the washer	The tube is blocked. The tank is empty. The pump hose is pinched.
The washer does not function	It is not connected to the power supply. There is main power on OFF. The circuit breaker protecting the electrical control circuit has been tripped. CONSULT THE MAINTENANCE DEPARTMENT.
Abnormal noise	One of the washing arms is touching one or more of the items to be washed. Check the loading of the washer

2. ALARMS HISTORY



In standby and during operation, Information about the washer (Alarm History and Washer Documentation) is available.



Pressing  opens a menu where you can pick from Alarm History or Washer Documentation.



Pressing the  will allow you to view the last ten alarms stored in memory. Use the page up/down icons to scroll through the alarms.

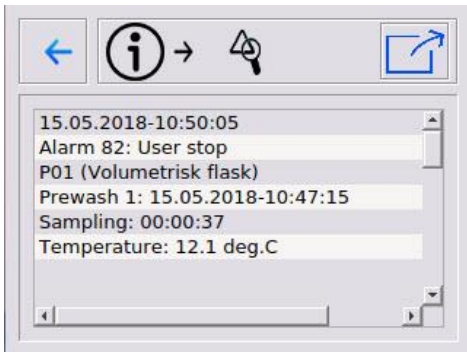

is only active in Standby mode. Pressing the icon will allow you to export the alarm history data to USB or the printer by pressing on the appropriate icon.

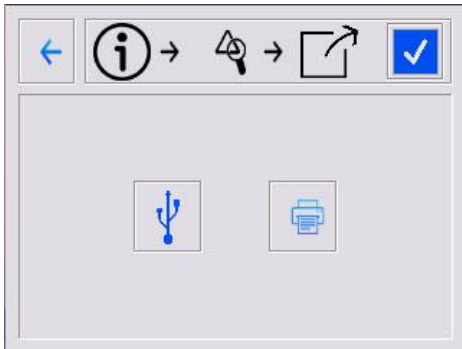

(If the printer option is not fitted on washer, the printer icon will be shown in grey to indicate that it is not active.)

3. WARNINGS

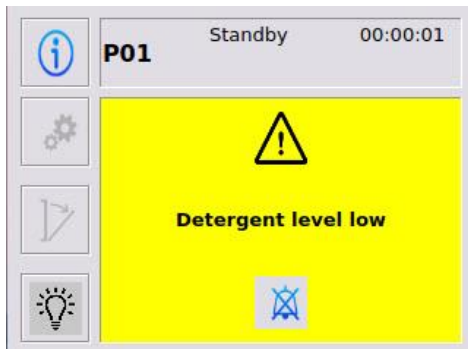

After the Start icon is pressed, the system checks for any problems and will notify the operator via warning messages.

Pressing  will clear the warning.

HOT CHAMBER	<p>The following message is displayed if the temperature inside the washing chamber is above the safety temperature set point for door opening.</p> <p>At the end of the cycle, let the washer chamber and contents cool before opening the chamber door.</p>
ACTIVE ALARM	At least one alarm is active
RECIPE ERROR	The selected recipe is not configured
ENTER A BATCH ID	Required batch ID is missing.
DOOR OPEN	Door is opened or unlocked.
<p>ADDITIVE 1 LOW LEVEL * optional for 810LX and 815 LX</p> <p>ADDITIVE 2 LOW LEVEL * optional for 810LX and 815 LX</p> <p>ADDITIVE 3 LOW LEVEL ** optional extra alkaline dosing pump</p> <p>ADDITIVE 4 LOW LEVEL ** optional extra alkaline dosing pump</p> <p>ADDITIVE 5 LOW LEVEL ** optional extra alkaline dosing pump</p>	<p>The following message is displayed at the start of the cycle.</p> <p>It is indispensable to replace the tank.</p> <p>Consider checking the level of other product tanks in order to avoid another alarm.</p> <p>The warning for low level prohibits the equipment to start if not the corrective action has been made to change chemical canister.</p>

END OF CYCLE : OPEN THE DOOR	Successful cycle completed. System waiting.
SERVICE TIME	After turning on the machine, the reminder of the upcoming preventative maintenance is shown on the display. Acknowledge the reminder. Schedule a preventative maintenance service call.
REGENERATION RENEWAL <i>* only for washers with water softener</i>	The following message is displayed at the start of the cycle. Fill the salt pot located inside the washer.

4. ALARMS TABLE

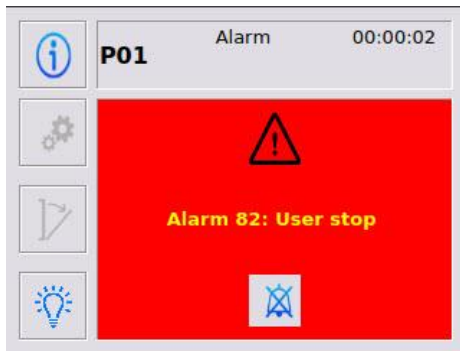

If an alarm occurs, the wash cycle is aborted and the appropriate alarm message is shown in red.

Pressing  will clear the alarm.

1	DRAINING FAULT	<p>During the draining phase, the washer as not been drained within the configured drain time.</p> <ul style="list-style-type: none"> - Check that drain pipe or drain valve/pump is not obstructed. - Verify operation of drain pump/valve. - Check drain time.
10	FILLING FAULT	<p>During the filling phase, the water high level switch was not reached within the configured filling time.</p> <ul style="list-style-type: none"> - Check opening of valves. - Check pressure of water supply. - Check filling time
18	<p>WATER LEVEL PRESSURE SWITCH DEFECT</p> <p><i>*Validation monitor option</i></p>	<p>The pressure switch indicates a water level inconsistency.</p> <ul style="list-style-type: none"> - Check the opening of the water inlet valves - Check the pressure switch and its wiring - Check the draining system
20	<p>COLUMN PRESSURE : OUT OF RANGE – LOW</p> <p><i>*prokit or validation monitor option or pressure transmitter option</i></p>	<p>Pressure is lower than the minimum set point programmed</p> <ul style="list-style-type: none"> - Check that the pump operates - Check the door switches - Check the transmitter calibration. - Check the foaming issues within the chamber
21	<p>COLUMN PRESSURE : UNEXPECTED</p> <p><i>*prokit or validation monitor option or pressure transmitter option</i></p>	<p>Pump pressure is above minimum set point value when pump not running.</p> <ul style="list-style-type: none"> - Check the transmitter (look at the pressure and calibrate it if necessary). - Check the low limit value for the pressure alarm. (This value is used for this alarm). - Pressure transmitter must give 0 when the pump is stopped
22	<p>COLUMN PRESSURE : OUT OF RANGE – HIGH</p> <p><i>*prokit or validation monitor option or pressure transmitter option</i></p>	<p>Pump pressure is above Max set point value</p> <ul style="list-style-type: none"> - Check the transmitter - Verify that there is no blockage in the column.

30	ADDITIVE 1 INTAKE: OUT OF RANGE – LOW * optional ProKIT or validation monitor	<p>During the cycle, the necessary amount of product is not correctly dosed.</p> <ul style="list-style-type: none"> - Check the tank level, - Check the dosing pump, the flowmeter.
31	ADDITIVE 2 INTAKE: OUT OF RANGE – LOW * optional ProKIT or validation monitor	
32	ADDITIVE 3 INTAKE: OUT OF RANGE – LOW * optional ProKIT or validation monitor	
33	ADDITIVE 4 INTAKE: OUT OF RANGE – LOW * optional ProKIT or validation monitor ** optional extra alkaline dosing pump	
86	ADDITIVE 5 INTAKE: OUT OF RANGE – LOW * optional ProKIT or validation monitor ** optional extra alkaline dosing pump	

34	ADDITIVE 1 INTAKE: UNEXPECTED * optional ProKIT or validation monitor	<p>A flow of product is detected outside a product intake phase.</p> <ul style="list-style-type: none"> - Check the flowmeter.
35	ADDITIVE 2 INTAKE: UNEXPECTED * optional ProKIT or validation monitor	
36	ADDITIVE 3 INTAKE: UNEXPECTED * optional ProKIT or validation monitor	
37	ADDITIVE 4 INTAKE: UNEXPECTED * optional ProKIT or validation monitor ** optional extra alkaline dosing pump	
87	ADDITIVE 5 INTAKE: UNEXPECTED * optional ProKIT or validation monitor ** optional extra alkaline dosing pump	

38	ADDITIVE 1 INTAKE: OUT OF RANGE – HIGH * optional ProKIT or validation monitor	<p>During the cycle, the necessary amount of product is not correctly dosed.</p> <ul style="list-style-type: none"> - Check the dosing pump, the flowmeter.
39	ADDITIVE 2 INTAKE: OUT OF RANGE – HIGH * optional ProKIT or validation monitor	
40	ADDITIVE 3 INTAKE: OUT OF RANGE – HIGH * optional ProKIT or validation monitor	
41	ADDITIVE 4 INTAKE: OUT OF RANGE – HIGH * optional ProKIT or validation monitor ** optional extra alkaline dosing pump	
88	ADDITIVE 5 INTAKE: OUT OF RANGE – HIGH * optional ProKIT or validation monitor ** optional extra alkaline dosing pump	

50	WATER TEMPERATURE EXCEEDS SET POINT	<p>The temperature is higher than set point + tolerance.</p> <ul style="list-style-type: none"> - Check the "HIGH LIMIT" parameter for water heating. - Check the water inlet temperature. - Verify the probe reads correctly. - Verify that the steam valve is closed. - Verify if the heating contactor is open.
51	HEATING FAULT	<p>During the heating phase if the water temperature has not increased by the set minimum slope.</p> <ul style="list-style-type: none"> - Check electrical connection, state of heating elements and safety thermal cut-out. - Verify that steam valve is opening (steam heating option) - Check the "INCREASE" parameter for water heating.
52	COLUMN DRYING FAULT <i>*Only LXP and 1800LXA models</i>	<p>During the heating phase the temperature has not reached the set point within 5 minutes</p> <ul style="list-style-type: none"> - Check the heaters - Check the probe
54	CHAMBER HEATING MAXIMUM TEMPERATURE	<p>The temperature is over the maximum allowed</p> <ul style="list-style-type: none"> - Check the probe max value parameter. - Check that the steam valve is operating properly (steam heating option) - Check the probe - Check the contactor
55	COLUMN DRYING MAXIMUM TEMPERATURE <i>*Only LXP and 1800LXA models</i>	<p>The temperature is over the maximum allowed</p> <ul style="list-style-type: none"> - Check the probe max value parameter. - Check the probe
70	HEATING : PROBE DEFECT	<p>Open wire, overrange or underrange</p> <ul style="list-style-type: none"> - Verify the probe. - Check the wire connections.
71	COLUMN DRYING : PROBE DEFECT	<p>Open wire, overrange or underrange</p> <ul style="list-style-type: none"> - Verify the probe. - Check the wire connections.
72	COLUMN 2 DRYING : PROBE DEFECT <i>*Only 1800LXA models</i>	
78	FINAL RINSE CONDUCTIVITY <i>*Conductivimeter option or conductivity measurement option</i>	<p>The final rinse conductivity is higher than the limit configured in the program settings.</p> <ul style="list-style-type: none"> - Check if the program is adapted to wash the parts, the water quality, the conductivity probe wiring. - Check set point. - Check conductivity probe calibration.
80	EMERGENCY STOP <i>*only 1800LXA</i>	To unlock the emergency stop button, turn the red head clockwise
82	USER STOP	Cycle aborted by user.

90	LOADING DOOR FAULT	The door was detected opened during cycle or failed to close/lock on request. - Check door closing and door switches.
97	SAMPLING TIME ELAPSED <i>*only for washer with sampling option</i>	Sampling break was not acknowledged within the sampling alarm delay. - Allow enough time to do the sampling. - Acknowledge sampling when done.
98	AIR PRESSURE <i>*only final rinse kit option and 1800LXA</i>	Air pressure not detected - Check the compressed air supply. - Check PLC I/O and wiring.
100	WATER HEATING TEMPERATURE PROBES : MAXIMUM DIFFERENCE <i>* only option validation monitor</i>	The difference of temperature between the probes of the washer and the probes of the Validation Monitor is too important (superior to 10°C). - Verify the temperature of the probes for the washer and for the Validation Monitor probes. - Change the settings if necessary.
101	DRYING HEATING TEMPERATURE PROBES : MAXIMUM DIFFERENCE <i>* only option validation monitor</i>	

CHAPTER 9

MAINTENANCE OF THE WASHER



NEVER USE OR PLACE IN THE WASHER REMMANTS OF PRODUCTS SUCH AS ACETONE, SOLVANTS, OIL, SULFO-CROMIC, PETROL DERIVATIVES, ACIDS (SULFURIC, NITRIC, CLORHIDRIC, EVEN AT LOW CONCENTRATIONS), ETC.



DURING THE CLEANING OPERATIONS INSIDE THE CHAMBER, IT IS CONVENIENT TO WEAR SAFETY GLOVES AND TO PAY ATTENTION TO THE EVENTUAL EDGE TOOLS (NEEDLES, INSTRUMENTS...) WHICH COULD BE PLACED INSIDE THE FILTERS OF THE BOTTOM OF THE CHAMBER.

1. CHAMBER FILTERS

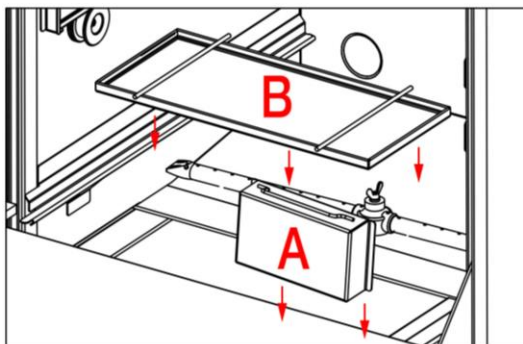

810LX – 815 LX – 820 LX – 910 LX – 1300 LX

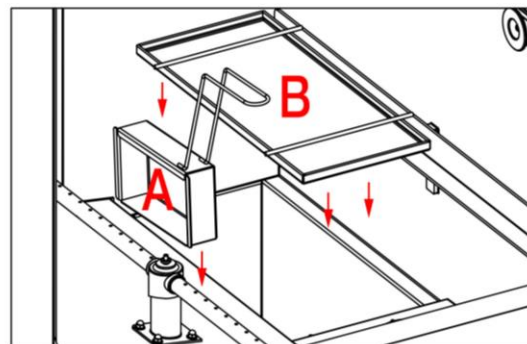

1400 LX – 1400 LXP – 1600 LXP

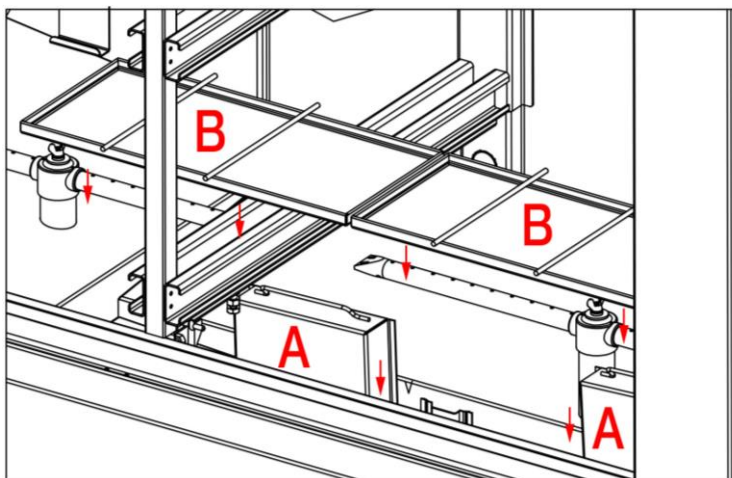

1800 LXA

Clean the filters after each cycle.

Place them correctly.

Order of fitting: A -> B

2. REGENERATING OF SOFTENER (OPTION)

Only for washers with water softener (option).

When the display unit indicates "SALT RECHARGE", it is essential to fill the salt pot located at the bottom of the chamber, inside the washer. Use special softening, regenerating salt.

- 1 Salt pot
- 2 Filling funnel
- 3 Salt pot cap

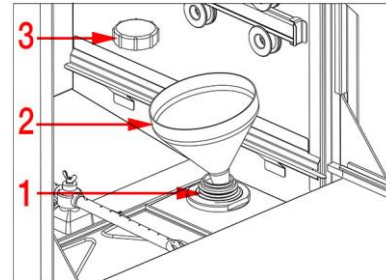

DO NOT FORGET TO REINSTALL SALT POT CAP AFTER FILLING WITH SALT

3. STRAINER FILTERS

Check the cleanness of the strainer filters and clean them if needed.

Debris in the filters will increase the filling times and could activate the alarm "FILLING FAULT".

The filters should be replaced each year.

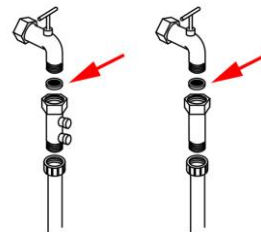

4. DRYING AIR FILTERS

(Not applicable to 810LX and 815LX)

The life duration of the drying air filters depends on the rate of use of the washer and the room air quality.

We recommend the preventive change of the drying air filters at least one time every year.

Check visually the state of the drying air filters every 6 months as stated in the preventive maintenance scheme

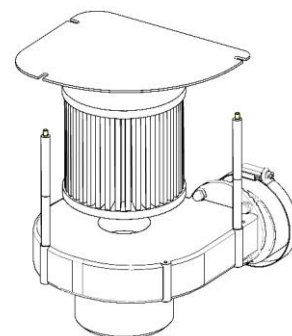

5. EXTERNAL MAINTENANCE OF THE WASHER

GETINGE LANCER washers are entirely covered with panels (bodywork) in stainless steel AISI 304L.

5.1 CLEANING THE TOUCH SCREEN PANEL

To clean the touch panel optimally, be sure to use a non-abrasive cloth:

- Turn off your device before cleaning.
- Choose an antistatic microfiber cloth.
- First clean your screen with the cloth by forming small circles.

Only when absolutely necessary, you can moisten the cloth with distilled water or a product specifically designed for touch screens before repeating the circular motion.



DO NOT APPLY TOO MUCH PRESSURE ON SCREEN WHEN CLEANING

5.2 CLEANING METHOD

Regular maintenance cleaning is done using a soft cleaning product.

In the event that regular cleaning tasks have been neglected for too long, we recommend using a special cleaner.

The product must be wiped on using a cloth or a soft sponge, being careful to rub the stainless steel in the direction of the grain on the panel to avoid any scratches.

For drying, good practice is to use a rubber scraper, as you would on glass surfaces; this avoids any shimmering effect that can be produced when cleaning with a cloth.



AVOID WATER RINSING DIRECTLY ON THE WASHER

5.3 CLEANING PRODUCTS FOR EXTERIOR PANELS

DETERGENTS, WASHING LIQUIDS:

All types of detergents, washing liquids and commercial soaps are generally usable, as long as they do not contain chlorinated products.

ABRASIVE POWDERS:

These products can scratch stainless steel surfaces and therefore change the appearance, at least in small areas. However, they can be useful to remove stubborn stains through rubbing.

ACID PRODUCTS:

The use of acid-based cleaning products should only be used in special cases.

Acetic acid can be used to remove stains caused by the buildup of limescale.

There are phosphoric acid or nitric acid based products that are specially designed for cleaning stainless steel. Strictly follow the manufacturer instructions when using them.



AFTER CLEANING IT IS NECESSARY TO ABONDANTLY RINSE WITH A SOFT CLOTH TO REMOVE TRACES OF THE CLEANING PRODUCTS THAT WERE USED

6. SHUT DOWN AT END OF DAY

- a) SHUT OFF THE WATER INLET VALVES so that the lines are not left pressurized. Do not forget to open them again before using the washer.
- b) SHUT DOWN THE APPLIANCE.

7. PREVENTIVE MAINTENANCE

GETINGE LANCER'S TECHNICAL ASSISTANCE SERVICE recommends to carry out a preventive maintenance action every year in order to guarantee the validity of the washing cycles and to ensure the operation of the washer.

The preventive maintenance reduced the risks of stoppings of the washer due to breakdowns and makes it possible to lengthen the lifespan of the equipment.

The washer stores the operational hours in memory. At the end of 900 operating hours, a message on the screen is shown to indicate that preventive maintenance is required.

The 900 hours are a guide line and it is advisable in the case of less frequent use of the washer to perform the preventive maintenance on an annual basis

Depending on the countries where the washer is used and the local norms, a higher frequency of preventive maintenance visits can be necessary.

8. PREVENTATIVE MAINTENANCE SCHEDULE

FUNCTION	Daily (1)	Biannual (2)	1 Year (2)
Clean filter system in chamber.	X	X	X
Check chemical containers for any leakage.	X	X	X
Ensure chemical hoses are not pinched.	X	X	X
Clean exterior panels.	X	X	X
Inspect water supply hoses for cracks, bulges, and leaks.		X	X
Ensure the water hose seals and filters are clean and have no cracks.		X	X
Check chemical supply hoses for cracks, bulges and leaks.		X	X
Inspect internal tubing on chemical pumps for wear.		X	X
Check chemical level sensors for correct operation.		X	X
Ensure all panels are properly secured.		X	X
Check all internal hoses for cracks, bulges and leaks.		X	X
Ensure all hose clamps are properly tightened.		X	X
Check all column seals for leaks and cracks.		X	X
Check spray arm support seals for leaks and cracks.		X	X
Check spray arms and bushings for wear.		X	X
Check door seal and gasket for leakage.		X	X
Inspect the door springs, door wheels, door cable, hooks, gas spring, mounting hardware, and door switch for proper operation.		X	X
Change the Hepa filter of the dryer <i>(if applicable)</i>		X	X
Check recycling and emptying pump seals for leakage and quiet operation.			X
Check for loose electrical connections at components and electronic cards.			X
Verify the correct operation of all relays and their associated components.			X
Verify the correct operation of the fan of the dryer <i>(if applicable)</i>			X
Verify the correct operation of the non-return valve in the drying system <i>(if applicable)</i>			X

(1) Daily maintenance must be handled by users staff.

(2) Others maintenances (bi-annual, 1 year) must be carry out by the GETINGE LANCER's technical assistance service.

9. RECOMMENDED SPARE PARTS

9.1 RECOMMENDED SPARE PARTS 810 LX – 815 LX

Description	Part #	Quantity/ Machine
Door Spring	12010003	2
Door wheels	46020064	2
Door cable	46040004	2
Emptying Pump 50/60 hz	23010150	1
Pressurestat	28020066	1
Autoclude™ Internal tubing	23080014	2
Acid pump	23030009	1
Detergent pump	23030010	1
Main Pump50/60hz	23010149	1
capacitor	26010023	1
Door Seal	14050003	1
Bottom Door Seal	04120002	1
Column Seal	14030041	2
Threaded Connection	33080026	2
Water Inlet Filter/Seal	17010025	3
Spray Arm Washer	31040012	2
Heating Relay	20030007	1

9.2 RECOMMENDED SPARE PARTS 820 LX

Description	Part #	Quantity/Machine
Door Spring	12010003	2
Door wheels	46020064	2
Door cable	46040004	2
Emptying Pump 50/60hz	23010150	1
Pressurestat	28020066	1
Autoclude™ Internal tubing	23080014	2
Acid pump	23030009	1
Detergent pump	23030010	1
Main Pump 50/60hz	23010149	1
capacitor	26010023	1
Door Seal	14050003	1
Bottom Door Seal	04120002	1
Column Seal	14030041	2
Threaded Connection	33080026	2
Water Inlet Filter/Seal	17010025	3
Spray Arm Washer	31040012	2
Heating Relay	20030007	1
HEPA filter of the dryer	17020033	1
Fan of the dryer	23080170	1

9.3 RECOMMENDED SPARE PARTS 910 LX

Description	Part #	Quantity / Machine
Door Spring	12010003	2
Door wheel	46020064	2
Door cable	46040004	2
Emptying Pump 50/60hz	23010150	1
Pressurestat	28020066	2
Autoclude™ Internal tubing	23080014	2
Acid pump	23030009	1
Detergent pump	23030010	1
Main Pump 50/60hz	23010149	1
Capacitor	26010023	1
Door Seal	14050003	1
Bottom Door Seal	04120002	1
Column Seal	14030041	3
Threaded Connection	33080026	3
Water Inlet Filter/Seal	17010025	3
Spray Arm Washer	31040012	2
Heating Relay	20030007	1
Drying Hepa filter	17020033	1
Fan of the dryer	23080170	1

9.4 RECOMMENDED SPARE PARTS 1300 LX

Description	Part #	Quantity / Machine
Door Spring	12010003	2
Door wheel	46020064	2
Door cable	46040004	2
Emptying Pump 50/60hz	23010150	1
Pressurestat	28020066	2
Autoclude™ Internal tubing	23080014	2
Acid pump	23030009	1
Detergent pump	23030010	1
Main Pump 50hz	23010117	1
Main Pump 60hz	23010118	
Capacitor 50hz	26010015	1
Capacitor 60hz	26010016	
Door Seal	14050003	1
Bottom Door Seal	04120002	1
Column Seal	14030041	4
Threaded Connection	33080026	4
Water Inlet Filter/Seal	17010025	3
Spray Arm Washer	31040012	2
Heating Relay	20030007	1
Drying Hepa filter	17020033	1
Fan of the dryer	23080170	1
Steam heating valve	38010124	1

9.5 RECOMMENDED SPARE PARTS 1400 LX / 1400 LXP

Description	Part #	Quantity / Machine
Emptying Pump 50hz	23010150	1
Emptying Pump 60hz	23010060	
Pressurestat	28020066	2
Autoclude™ Internal tubing	23080014	2
Acid pump	23030009	1
Detergent pump	23030010	1
Main Pump 50hz		1
• 400v tri/50hz	23010052	
• 400v tri without neutral/50hz	23010036	
• 230v tri/50hz	23010036	
• 200v tri/50hz	23010048	
Main Pump 60hz		
• 200v tri/60hz	23010049	
• 208v 60hz	23010036	
• 230v tri/60hz	23010055	
• 480v tri/60hz	23010055	
• 400v tri/60hz	23010055	
• 400v tri without neutral /60hz	23010052	
Door Seal	14040025	1
Bottom Door Seal	04120002	1
Column Seal	14030041	4
Threaded Connection	33080026	4
Water Inlet Filter/Seal	17010025	3
Heating Relay	20030007	2
Drying Hepa filter	17020033	2 (3 if the washer is equipped with super drying option)
Fan of the dryer	23080170	1
Steam heating valve (electric)	38010124	1
Steam heating valve (pneumatic)	38010015	1
	37010207	1

9.6 RECOMMENDED SPARE PARTS 1600 LXP

Description	Part #	Quantity/Machine
Emptying Pump 50hz	23010009	1
Emptying Pump 60hz	23010060	
Pressurestat	28020066	2
Autoclude™ Internal tubing	23080014	2
Acid pump	23030009	1
Detergent pump	23030010	1
Main Pump 50hz		1
• 400v tri/50hz	23010054	
• 400v tri without neutral/50hz	23010054	
• 230v tri/50hz	23010054	
• 200v tri/50hz	23010054	
Main Pump 60hz		
• 200v tri/60hz	23010056	

• 208v 60hz	23010050	
• 230v tri/60hz	23010056	
• 480v tri/60hz	23010056	
• 400v tri/60hz	23010056	
• 400v tri sans neutre/60hz	23010056	
Door Seal	14040027	1
Bottom Door Seal	04120002	1
Column Seal	14030041	5
Threaded Connection	33080026	5
Water Inlet Filter/Seal	17010025	3
Heating Relay	20030007	3
HEPA filter of the dryer	17020033	3
Fan of the dryer	23080170	1
Steam heating valve (electric)	38010124	1
Steam heating valve (pneumatic)	38010015	1
	37010207	1

9.7 RECOMMENDED SPARE PARTS 1800 LXA

Description	Part #	Quantity / Machine
Emptying Pump 50hz	23010150	1
Emptying Pump 60hz	23010060	
Pressurestat	28020066	2
Autoclude™ Internal tubing	23080014	2
Acid pump	23030009	1
Detergent pump	23030010	1
Main Pump 50hz		
• 400v tri/50hz	23010052	
• 400v tri without neutral/50hz	23010036	
• 230v tri/50hz	23010036	
• 200v tri/50hz	23010048	
Main Pump 60hz		1
• 200v tri/60hz	23010049	
• 208v 60hz	23010036	
• 230v tri/60hz	23010055	
• 480v tri/60hz	23010055	
• 400v tri/60hz	23010055	
• 400v tri without neutral /60hz	23010052	
Door Seal	14040046	1
Column Seal	14030041	8
Threaded Connection	33080026	8
Water Inlet Filter/Seal	17010025	6
Heating Relay	20030007	4
Drying Hepa filter	17020033	4
Fan of the dryer	23080170	1
Steam heating valve (electric)	38010124	1
Steam heating valve (pneumatic)	38010015	1
	37010207	1

10. DISPOSAL OF WASHER

At the end of life of the washer, the users' attention is drawn to the requirement not to dispose of waste electrical and electronic equipment (WEEE) as unsorted municipal waste and to collect such WEEE separately.



CHAPTER 10

WASHING PROGRAMS

1. FACTORY PROGRAMMED CYCLE



PROGRAMS PREESTABLISHED WITH THIS WASHER HAVE BEEN VALIDATED WITH THE GETINGE LANCER BRAND WASHING PRODUCTS, the LLL DETERGENT AND THE NLL NEUTRALISANT.

1.1 CONSUMPTION OF WATER PER OPERATION AND MODEL

The estimated consumption of water per operation (depending on the baskets used):

	810 LX 815 LX	820 LX	910 LX	1300 LX	1400 LX 1400LXP	1600LXP	1800 LXA
Estimated consumption of water per operation (depending on the used baskets)	12 liters	12 liters	13 liters	15 liters	20 liters	30 liters	40 liters

1.2 LABELLING OF WATERS ACCORDING TO STANDARD AND OPTIONS

Water designation	Standard washer	Washer with softener option *
Water 1	Cold Water	Cold Water
Water 2	Purified Water	Purified Water
Water 3*	Hot Water *	Hot Water *
Water 4		Cold Softened Water
Water 5		Hot Softened Water

* Not applicable on 810LX and 815 LX

1.3 810 LX - FACTORY PROGRAMMED CYCLE

* Please refer page 73 for the water's name

SEQUENCES	POSSIBILITIES	Volumetric	Bacterio.	Chemistry	Agarose Gel
		Flasks	Virology	Biology	
		PROG. 01	PROG. 02	PROG. 03	PROG. 04
PREWASH TIME 1	0 TO 30 MN	1	2	2	2
FILLING	1 / 2 / 3 / 4 / 5 *	1	1	1	1
PREWASH 1 TEMPERATURE	0 TO 95 °C	0	0	0	90
PREWASH 1 DETERGENT	0 TO 9999 ml	24	24	24	96
OPTION : PREWASH 1 DETERGENT 2	0 TO 9999 ml	0	0	0	0
OPTION : PREWASH 1 NEUTRALIZATION	0 TO 9999 ml	12	12	12	48
PREWASH TIME 2	0 TO 30 MN	0	0	0	1
FILLING	1 / 2 / 3 / 4 / 5 *	/	/	/	1
PREWASH 2 TEMPERATURE	0 TO 95 °C	/	/	/	0
PREWASH 2 DETERGENT	0 TO 9999 ml	/	/	/	0
OPTION : PREWASH 2 DETERGENT 2	0 TO 9999 ml	/	/	/	0
OPTION : PREWASH 2 NEUTRALIZATION	0 TO 9999 ml	/	/	/	0
PREWASH TIME 3	0 TO 30 MN	0	0	0	0
FILLING	1 / 2 / 3 / 4 / 5 *	/	/	/	/
PREWASH 3 TEMPERATURE	0 TO 95 °C	/	/	/	/
PREWASH 3 DETERGENT	0 TO 9999 ml	/	/	/	/
OPTION : PREWASH 3 DETERGENT 2	0 TO 9999 ml	/	/	/	/
OPTION : PREWASH 3 NEUTRALIZATION	0 TO 9999 ml	/	/	/	/
WASH TIME	0 TO 30 MN	4	4	2	2
FILLING	1 / 2 / 3 / 4 / 5 *	1	1	1	1
WASH TEMPERATURE	0 TO 95 °C	50	85	70	90
WASH DETERGENT	0 TO 9999 ml	96	96	96	120
OPTION : WASH DETERGENT 2	0 TO 9999 ml	0	0	0	0
OPTION : WASH NEUTRALIZATION	0 TO 9999 ml	48	48	48	60
RINSE TIME A	0 TO 30 MN	1	1	1	1
FILLING	1 / 2 / 3 / 4 / 5 *	1	1	1	1
RINSE A TEMPERATURE	0 TO 95 °C	/	/	/	/
RINSE A	0 TO 9	/	/	2	2
ACID RINSE TIME	0 TO 30 MN	2	2	2	2
FILLING	1 / 2 / 3 / 4 / 5 *	1	1	1	1
ACID RINSE TEMPERATURE	0 TO 95 °C	0	0	0	0
NEUTRALIZING ACID	0 TO 9999 ml	96	96	96	96
OPTION : ACID RINSE NEUTRALIZATION	0 TO 9999 ml	192	192	192	192
RINSE TIME B	0 TO 30 MN	1	1	1	1
FILLING	1 / 2 / 3 / 4 / 5 *	1	1	1	1
RINSE B TEMPERATURE	0 TO 95 °C	/	/	/	/
RINSE B	0 TO 9	/	2	/	/
RINSE TIME 1	0 TO 30 MN	1	0	1	1
FILLING	1 / 2 / 3 / 4 / 5 *	2	/	2	2
RINSE 1 TEMPERATURE	0 TO 95 °C	/	/	/	/
RINSE TIME 2	0 TO 30 MN	/	/	/	/
FILLING	1 / 2 / 3 / 4 / 5 *	/	/	/	/
RINSE 2 TIME TEMPERATURE	0 TO 95 °C	/	/	/	/
RINSE TIME 3	0 TO 30 MN	/	/	/	/
FILLING	1 / 2 / 3 / 4 / 5 *	/	/	/	/
RINSE 3 TEMPERATURE	0 TO 95 °C	/	/	/	/
RINSE TIME 4	0 TO 30 MN	/	/	/	/
FILLING	1 / 2 / 3 / 4 / 5 *	/	/	/	/
RINSE 4 TEMPERATURE	0 TO 95 °C	/	/	/	/
FINAL RINSE TIME	0 TO 30 MN	1	1	1	1
FILLING	1 / 2 / 3 / 4 / 5 *	2	2	2	2
FINAL RINSE TEMPERATURE	0 TO 95 °C	50	80	80	80
DRYING TIME	0 TO 30 MN	/	/	/	/
DRYING	0 TO 110°C	/	/	/	/
COOLING	0 TO 30 MN	/	/	/	/

1.4 815 LX - FACTORY PROGRAMMED CYCLE - STANDARD

* Please refer page 73 for the water's name

SEQUENCES	POSSIBILITIES	Volumetric	Bacterio.	Chemistry	Agarose Gel
		Flasks	Virology	Biology	
		PROG. 01	PROG. 02	PROG. 03	PROG. 04
PREWASH TIME 1	0 TO 30 MN	1	2	2	2
FILLING	1 / 2 / 3 / 4 / 5 *	1	1	1	1
PREWASH 1 TEMPERATURE	0 TO 95 °C	0	0	0	90
PREWASH 1 DETERGENT	0 TO 9999 ml	24	24	24	96
OPTION : PREWASH 1 DETERGENT 2	0 TO 9999 ml	0	0	0	0
OPTION : PREWASH 1 NEUTRALIZATION	0 TO 9999 ml	12	12	12	48
PREWASH TIME 2	0 TO 30 MN	0	0	0	1
FILLING	1 / 2 / 3 / 4 / 5 *	/	/	/	1
PREWASH 2 TEMPERATURE	0 TO 95 °C	/	/	/	0
PREWASH 2 DETERGENT	0 TO 9999 ml	/	/	/	0
OPTION : PREWASH 2 DETERGENT 2	0 TO 9999 ml	/	/	/	0
OPTION : PREWASH 2 NEUTRALIZATION	0 TO 9999 ml	/	/	/	0
PREWASH TIME 3	0 TO 30 MN	0	0	0	0
FILLING	1 / 2 / 3 / 4 / 5 *	/	/	/	/
PREWASH 3 TEMPERATURE	0 TO 95 °C	/	/	/	/
PREWASH 3 DETERGENT	0 TO 9999 ml	/	/	/	/
OPTION : PREWASH 3 DETERGENT 2	0 TO 9999 ml	/	/	/	/
OPTION : PREWASH 3 NEUTRALIZATION	0 TO 9999 ml	/	/	/	/
WASH TIME	0 TO 30 MN	4	4	2	2
FILLING	1 / 2 / 3 / 4 / 5 *	1	1	1	1
WASH TEMPERATURE	0 TO 95 °C	50	85	70	90
WASH DETERGENT	0 TO 9999 ml	96	96	96	120
OPTION : WASH DETERGENT 2	0 TO 9999 ml	0	0	0	0
OPTION : WASH NEUTRALIZATION	0 TO 9999 ml	48	48	48	60
RINSE TIME A	0 TO 30 MN	1	1	1	1
FILLING	1 / 2 / 3 / 4 / 5 *	1	1	1	1
RINSE A TEMPERATURE	0 TO 95 °C	/	/	/	/
RINSE A	0 TO 9	/	/	2	2
ACID RINSE TIME	0 TO 30 MN	2	2	2	2
FILLING	1 / 2 / 3 / 4 / 5 *	1	1	1	1
ACID RINSE TEMPERATURE	0 TO 95 °C	0	0	0	0
NEUTRALIZING ACID	0 TO 9999 ml	96	96	96	96
OPTION : ACID RINSE NEUTRALIZATION	0 TO 9999 ml	192	192	192	192
RINSE TIME B	0 TO 30 MN	1	1	1	1
FILLING	1 / 2 / 3 / 4 / 5 *	1	1	1	1
RINSE B TEMPERATURE	0 TO 95 °C	/	/	/	/
RINSE B	0 TO 9	/	2	/	/
RINSE TIME 1	0 TO 30 MN	1	0	1	1
FILLING	1 / 2 / 3 / 4 / 5 *	2	/	2	2
RINSE 1 TEMPERATURE	0 TO 95 °C	/	/	/	/
RINSE TIME 2	0 TO 30 MN	/	/	/	/
FILLING	1 / 2 / 3 / 4 / 5 *	/	/	/	/
RINSE 2 TIME TEMPERATURE	0 TO 95 °C	/	/	/	/
RINSE TIME 3	0 TO 30 MN	/	/	/	/
FILLING	1 / 2 / 3 / 4 / 5 *	/	/	/	/
RINSE 3 TEMPERATURE	0 TO 95 °C	/	/	/	/
RINSE TIME 4	0 TO 30 MN	/	/	/	/
FILLING	1 / 2 / 3 / 4 / 5 *	/	/	/	/
RINSE 4 TEMPERATURE	0 TO 95 °C	/	/	/	/
FINAL RINSE TIME	0 TO 30 MN	1	1	1	1
FILLING	1 / 2 / 3 / 4 / 5 *	2	2	2	2
FINAL RINSE TEMPERATURE	0 TO 95 °C	50	80	80	80
DRYING TIME	0 TO 30 MN	/	25	25	25
DRYING	0 TO 110°C	/	100	100	100
COOLING	0 TO 30 MN	/	5	5	5

1.5 815 LX - FACTORY PROGRAMMED CYCLE – 120V MONO/60HZ

* Please refer page 73 for the water's name

SEQUENCES	POSSIBILITIES	Volumetric	Bacterio.	Chemistry	Agarose Gel
		Flasks	Virology	Biology	
		PROG. 01	PROG. 02	PROG. 03	PROG. 04
PREWASH TIME 1	0 TO 30 MN	1	2	2	2
FILLING	1 / 2 / 3 / 4 / 5 *	1	1	1	1
PREWASH 1 TEMPERATURE	0 TO 95 °C	0	0	0	80
PREWASH 1 DETERGENT	0 TO 9999 ml	24	24	24	96
OPTION : PREWASH 1 DETERGENT 2	0 TO 9999 ml	0	0	0	0
OPTION : PREWASH 1 NEUTRALIZATION	0 TO 9999 ml	12	12	12	48
PREWASH TIME 2	0 TO 30 MN	0	0	0	1
FILLING	1 / 2 / 3 / 4 / 5 *	/	/	/	1
PREWASH 2 TEMPERATURE	0 TO 95 °C	/	/	/	0
PREWASH 2 DETERGENT	0 TO 9999 ml	/	/	/	0
OPTION : PREWASH 2 DETERGENT 2	0 TO 9999 ml	/	/	/	0
OPTION : PREWASH 2 NEUTRALIZATION	0 TO 9999 ml	/	/	/	0
PREWASH TIME 3	0 TO 30 MN	0	0	0	0
FILLING	1 / 2 / 3 / 4 / 5 *	/	/	/	/
PREWASH 3 TEMPERATURE	0 TO 95 °C	/	/	/	/
PREWASH 3 DETERGENT	0 TO 9999 ml	/	/	/	/
OPTION : PREWASH 3 DETERGENT 2	0 TO 9999 ml	/	/	/	/
OPTION : PREWASH 3 NEUTRALIZATION	0 TO 9999 ml	/	/	/	/
WASH TIME	0 TO 30 MN	4	4	2	2
FILLING	1 / 2 / 3 / 4 / 5 *	1	1	1	1
WASH TEMPERATURE	0 TO 95 °C	50	60	70	80
WASH DETERGENT	0 TO 9999 ml	96	96	96	120
OPTION : WASH DETERGENT 2	0 TO 9999 ml	0	0	0	0
OPTION : WASH NEUTRALIZATION	0 TO 9999 ml	48	48	48	60
RINSE TIME A	0 TO 30 MN	1	1	1	1
FILLING	1 / 2 / 3 / 4 / 5 *	1	1	1	1
RINSE A TEMPERATURE	0 TO 95 °C	/	/	/	/
RINSE A	0 TO 9	/	/	2	2
ACID RINSE TIME	0 TO 30 MN	2	2	2	2
FILLING	1 / 2 / 3 / 4 / 5 *	1	1	1	1
ACID RINSE TEMPERATURE	0 TO 95 °C	0	0	0	0
NEUTRALIZING ACID	0 TO 9999 ml	96	96	96	96
OPTION : ACID RINSE NEUTRALIZATION	0 TO 9999 ml	192	192	192	192
RINSE TIME B	0 TO 30 MN	1	1	1	1
FILLING	1 / 2 / 3 / 4 / 5 *	1	1	1	1
RINSE B TEMPERATURE	0 TO 95 °C	/	/	/	/
RINSE B	0 TO 9	/	2	/	/
RINSE. TIME 1	0 TO 30 MN	1	0	1	1
FILLING	1 / 2 / 3 / 4 / 5 *	2	/	2	2
RINSE 1 TEMPERATURE	0 TO 95 °C	/	/	/	/
RINSE TIME 2	0 TO 30 MN	/	/	/	/
FILLING	1 / 2 / 3 / 4 / 5 *	/	/	/	/
RINSE 2 TIME TEMPERATURE	0 TO 95 °C	/	/	/	/
RINSE TIME 3	0 TO 30 MN	/	/	/	/
FILLING	1 / 2 / 3 / 4 / 5 *	/	/	/	/
RINSE 3 TEMPERATURE	0 TO 95 °C	/	/	/	/
RINSE TIME 4	0 TO 30 MN	/	/	/	/
FILLING	1 / 2 / 3 / 4 / 5 *	/	/	/	/
RINSE 4 TEMPERATURE	0 TO 95 °C	/	/	/	/
FINAL RINSE TIME	0 TO 30 MN	1	1	1	1
FILLING	1 / 2 / 3 / 4 / 5 *	2	2	2	2
FINAL RINSE TEMPERATURE	0 TO 95 °C	50	60	60	60
DRYING TIME	0 TO 30 MN	/	25	25	25
DRYING	0 TO 110°C	/	100	100	100
COOLING	0 TO 30 MN	/	5	5	5

1.6 820LX - FACTORY PROGRAMMED CYCLE

* Please refer page 73 for the water's name

SEQUENCES	POSSIBILITIES	Volumetric	Bacterio.	Chemistry	Agarose Gel
		Flasks	Virology	Biology	
		PROG. 01	PROG. 02	PROG. 03	PROG. 04
PREWASH TIME 1	0 TO 30 MN	1	2	2	2
FILLING	1 / 2 / 3 / 4 / 5 *	4	4	4	5
PREWASH 1 TEMPERATURE	0 TO 95 °C	0	0	0	90
PREWASH 1 DETERGENT	0 TO 9999 ml	24	24	24	96
OPTION : PREWASH 1 DETERGENT 2	0 TO 9999 ml	0	0	0	0
OPTION : PREWASH 1 NEUTRALIZATION	0 TO 9999 ml	12	12	12	48
PREWASH TIME 2	0 TO 30 MN	0	0	0	1
FILLING	1 / 2 / 3 / 4 / 5 *	/	/	/	4
PREWASH 2 TEMPERATURE	0 TO 95 °C	/	/	/	0
PREWASH 2 DETERGENT	0 TO 9999 ml	/	/	/	0
OPTION : PREWASH 2 DETERGENT 2	0 TO 9999 ml	/	/	/	0
OPTION : PREWASH 2 NEUTRALIZATION	0 TO 9999 ml	/	/	/	0
PREWASH TIME 3	0 TO 30 MN	0	0	0	0
FILLING	1 / 2 / 3 / 4 / 5 *	/	/	/	/
PREWASH 3 TEMPERATURE	0 TO 95 °C	/	/	/	/
PREWASH 3 DETERGENT	0 TO 9999 ml	/	/	/	/
OPTION : PREWASH 3 DETERGENT 2	0 TO 9999 ml	/	/	/	/
OPTION : PREWASH 3 NEUTRALIZATION	0 TO 9999 ml	/	/	/	/
WASH TIME	0 TO 30 MN	4	4	2	2
FILLING	1 / 2 / 3 / 4 / 5 *	5	5	5	5
WASH TEMPERATURE	0 TO 95 °C	50	85	70	90
WASH DETERGENT	0 TO 9999 ml	96	96	96	120
OPTION : WASH DETERGENT 2	0 TO 9999 ml	0	0	0	0
OPTION : WASH NEUTRALIZATION	0 TO 9999 ml	48	48	48	60
RINSE TIME A	0 TO 30 MN	1	1	1	1
FILLING	1 / 2 / 3 / 4 / 5 *	1	1	1	1
RINSE A TEMPERATURE	0 TO 95 °C	/	/	/	/
RINSE A	0 TO 9	/	/	2	2
ACID RINSE TIME	0 TO 30 MN	2	2	2	2
FILLING	1 / 2 / 3 / 4 / 5 *	1	1	1	1
ACID RINSE TEMPERATURE	0 TO 95 °C	0	0	0	0
NEUTRALIZING ACID	0 TO 9999 ml	96	96	96	96
OPTION : ACID RINSE NEUTRALIZATION	0 TO 9999 ml	192	192	192	192
RINSE TIME B	0 TO 30 MN	1	1	1	1
FILLING	1 / 2 / 3 / 4 / 5 *	1	1	1	1
RINSE B TEMPERATURE	0 TO 95 °C	/	/	/	/
RINSE B	0 TO 9	/	2	/	/
RINSE TIME 1	0 TO 30 MN	1	0	1	1
FILLING	1 / 2 / 3 / 4 / 5 *	2	/	2	2
RINSE 1 TEMPERATURE	0 TO 95 °C	/	/	/	/
RINSE TIME 2	0 TO 30 MN	0	0	1	0
FILLING	1 / 2 / 3 / 4 / 5 *	/	/	2	/
RINSE 2 TIME TEMPERATURE	0 TO 95 °C	/	/	/	/
RINSE TIME 3	0 TO 30 MN	0	0	0	0
FILLING	1 / 2 / 3 / 4 / 5 *	/	/	/	/
RINSE 3 TEMPERATURE	0 TO 95 °C	/	/	/	/
RINSE TIME 4	0 TO 30 MN	0	0	0	0
FILLING	1 / 2 / 3 / 4 / 5 *	/	/	/	/
RINSE 4 TEMPERATURE	0 TO 95 °C	/	/	/	/
FINAL RINSE TIME	0 TO 30 MN	1	1	1	1
FILLING	1 / 2 / 3 / 4 / 5 *	2	2	2	2
FINAL RINSE TEMPERATURE	0 TO 95 °C	50	80	80	80
DRYING TIME	0 TO 30 MN	10	25	25	25
DRYING	Adjust. / Maxi	Adjust.	Maxi	Maxi	Maxi
COOLING	0 TO 30 MN	0	5	5	5

1.7 910 LX - FACTORY PROGRAMMED CYCLE

* Please refer page 73 for the water's name

SEQUENCES	POSSIBILITIES	Volumetric Flasks PROG. 01	Bacterio. Virology PROG. 02	Chemistry Biology PROG. 03	Agarose Gel PROG. 04
PREWASH TIME 1	0 TO 30 MN	1	2	2	2
FILLING	1 / 2 / 3 / 4 / 5 *	4	4	4	5
PREWASH 1 TEMPERATURE	0 TO 95 °C	0	0	0	90
PREWASH 1 DETERGENT	0 TO 9999 ml	26	26	26	104
OPTION : PREWASH 1 DETERGENT 2	0 TO 9999 ml	0	0	0	0
OPTION : PREWASH 1 NEUTRALIZATION	0 TO 9999 ml	13	13	13	52
PREWASH TIME 2	0 TO 30 MN	0	0	0	1
FILLING	1 / 2 / 3 / 4 / 5 *	/	/	/	4
PREWASH 2 TEMPERATURE	0 TO 95 °C	/	/	/	0
PREWASH 2 DETERGENT	0 TO 9999 ml	/	/	/	0
OPTION : PREWASH 2 DETERGENT 2	0 TO 9999 ml	/	/	/	0
OPTION : PREWASH 2 NEUTRALIZATION	0 TO 9999 ml	/	/	/	0
PREWASH TIME 3	0 TO 30 MN	0	0	0	0
FILLING	1 / 2 / 3 / 4 / 5 *	/	/	/	/
PREWASH 3 TEMPERATURE	0 TO 95 °C	/	/	/	/
PREWASH 3 DETERGENT	0 TO 9999 ml	/	/	/	/
OPTION : PREWASH 3 DETERGENT 2	0 TO 9999 ml	/	/	/	/
OPTION : PREWASH 3 NEUTRALIZATION	0 TO 9999 ml	/	/	/	/
WASH TIME	0 TO 30 MN	4	4	2	2
FILLING	1 / 2 / 3 / 4 / 5 *	5	5	5	5
WASH TEMPERATURE	0 TO 95 °C	50	85	70	90
WASH DETERGENT	0 TO 9999 ml	104	104	104	130
OPTION : WASH DETERGENT 2	0 TO 9999 ml	0	0	0	0
OPTION : WASH NEUTRALIZATION	0 TO 9999 ml	52	52	52	65
RINSE TIME A	0 TO 30 MN	1	1	1	1
FILLING	1 / 2 / 3 / 4 / 5 *	1	1	1	1
RINSE A TEMPERATURE	0 TO 95 °C	/	/	/	/
RINSE A	0 TO 9	/	/	2	2
ACID RINSE TIME	0 TO 30 MN	2	2	2	2
FILLING	1 / 2 / 3 / 4 / 5 *	1	1	1	1
ACID RINSE TEMPERATURE	0 TO 95 °C	0	0	0	0
NEUTRALIZING ACID	0 TO 9999 ml	104	104	104	104
OPTION : ACID RINSE NEUTRALIZATION	0 TO 9999 ml	208	208	208	208
RINSE TIME B	0 TO 30 MN	1	1	1	1
FILLING	1 / 2 / 3 / 4 / 5 *	1	1	1	1
RINSE B TEMPERATURE	0 TO 95 °C	/	/	/	/
RINSE B	0 TO 9	/	2	/	/
RINSE TIME 1	0 TO 30 MN	1	0	1	1
FILLING	1 / 2 / 3 / 4 / 5 *	2	/	2	2
RINSE 1 TEMPERATURE	0 TO 95 °C	/	/	/	/
RINSE TIME 2	0 TO 30 MN	0	0	1	0
FILLING	1 / 2 / 3 / 4 / 5 *	/	/	2	/
RINSE 2 TIME TEMPERATURE	0 TO 95 °C	/	/	/	/
RINSE TIME 3	0 TO 30 MN	0	0	0	0
FILLING	1 / 2 / 3 / 4 / 5 *	/	/	/	/
RINSE 3 TEMPERATURE	0 TO 95 °C	/	/	/	/
RINSE TIME 4	0 TO 30 MN	0	0	0	0
FILLING	1 / 2 / 3 / 4 / 5 *	/	/	/	/
RINSE 4 TEMPERATURE	0 TO 95 °C	/	/	/	/
FINAL RINSE TIME	0 TO 30 MN	1	1	1	1
FILLING	1 / 2 / 3 / 4 / 5 *	2	2	2	2
FINAL RINSE TEMPERATURE	0 TO 95 °C	50	80	80	80
DRYING TIME	0 TO 30 MN	10	25	25	25
DRYING	Adjust. / Maxi	Adjust.	Maxi	Maxi	Maxi
COOLING	0 TO 30 MN	0	5	5	5

1.8 1300 LX - FACTORY PROGRAMMED CYCLE - STANDARD

* Please refer page 73 for the water's name

SEQUENCES	POSSIBILITIES	Volumetric Flasks PROG. 01	Bacterio. Virology PROG. 02	Chemistry Biology PROG. 03	Agarose Gel PROG. 04
PREWASH TIME 1	0 TO 30 MN	1	2	2	2
FILLING	1 / 2 / 3 / 4 / 5 *	1	1	1*	3
PREWASH 1 TEMPERATURE	0 TO 95 °C	0	0	0	90
PREWASH 1 DETERGENT	0 TO 9999 ml	30	30	30	120
OPTION : PREWASH 1 DETERGENT 2	0 TO 9999 ml	0	0	0	0
OPTION : PREWASH 1 NEUTRALIZATION	0 TO 9999 ml	15	15	15	60
PREWASH TIME 2	0 TO 30 MN	0	0	0	1
FILLING	1 / 2 / 3 / 4 / 5 *	/	/	/	1
PREWASH 2 TEMPERATURE	0 TO 95 °C	/	/	/	0
PREWASH 2 DETERGENT	0 TO 9999 ml	/	/	/	0
OPTION : PREWASH 2 DETERGENT 2	0 TO 9999 ml	/	/	/	0
OPTION : PREWASH 2 NEUTRALIZATION	0 TO 9999 ml	/	/	/	0
PREWASH TIME 3	0 TO 30 MN	0	0	0	0
FILLING	1 / 2 / 3 / 4 / 5 *	/	/	/	/
PREWASH 3 TEMPERATURE	0 TO 95 °C	/	/	/	/
PREWASH 3 DETERGENT	0 TO 9999 ml	/	/	/	/
OPTION : PREWASH 3 DETERGENT 2	0 TO 9999 ml	/	/	/	/
OPTION : PREWASH 3 NEUTRALIZATION	0 TO 9999 ml	/	/	/	/
WASH TIME	0 TO 30 MN	4	4	2	2
FILLING	1 / 2 / 3 / 4 / 5 *	3	3	3	3
WASH TEMPERATURE	0 TO 95 °C	50	85	70	90
WASH DETERGENT	0 TO 9999 ml	120	120	120	150
OPTION : WASH DETERGENT 2	0 TO 9999 ml	0	0	0	0
OPTION : WASH NEUTRALIZATION	0 TO 9999 ml	60	60	60	75
RINSE TIME A	0 TO 30 MN	1	1	1	1
FILLING	1 / 2 / 3 / 4 / 5 *	1	1	1	1
RINSE A TEMPERATURE	0 TO 95 °C	/	/	/	/
RINSE A	0 TO 9	/	/	2	2
ACID RINSE TIME	0 TO 30 MN	2	2	2	2
FILLING	1 / 2 / 3 / 4 / 5 *	1	1	1	1
ACID RINSE TEMPERATURE	0 TO 95 °C	0	0	0	0
NEUTRALIZING ACID	0 TO 9999 ml	120	120	120	120
OPTION : ACID RINSE NEUTRALIZATION	0 TO 9999 ml	240	240	240	240
RINSE TIME B	0 TO 30 MN	1	1	1	1
FILLING	1 / 2 / 3 / 4 / 5 *	1	1	1	1
RINSE B TEMPERATURE	0 TO 95 °C	/	/	/	/
RINSE B	0 TO 9	/	2	/	/
RINSE TIME 1	0 TO 30 MN	1	0	1	1
FILLING	1 / 2 / 3 / 4 / 5 *	2	/	2	2
RINSE 1 TEMPERATURE	0 TO 95 °C	/	/	/	/
RINSE TIME 2	0 TO 30 MN	0	0	1	0
FILLING	1 / 2 / 3 / 4 / 5 *	/	/	2	/
RINSE 2 TIME TEMPERATURE	0 TO 95 °C	/	/	/	/
RINSE TIME 3	0 TO 30 MN	0	0	0	0
FILLING	1 / 2 / 3 / 4 / 5 *	/	/	/	/
RINSE 3 TEMPERATURE	0 TO 95 °C	/	/	/	/
RINSE TIME 4	0 TO 30 MN	0	0	0	0
FILLING	1 / 2 / 3 / 4 / 5 *	/	/	/	/
RINSE 4 TEMPERATURE	0 TO 95 °C	/	/	/	/
FINAL RINSE TIME	0 TO 30 MN	1	1	1	1
FILLING	1 / 2 / 3 / 4 / 5 *	2	2	2	2
FINAL RINSE TEMPERATURE	0 TO 95 °C	50	80	80	80
DRYING TIME	0 TO 30 MN	10	25	25	25
DRYING	Adjust. / Maxi	Adjust.	Maxi	Maxi	Maxi
COOLING	0 TO 30 MN	0	5	5	5

1.9 1300 LX - FACTORY PROGRAMMED CYCLE – SOFTENER OPTION

* Please refer page 73 for the water's name

SEQUENCES	POSSIBILITIES	Volumetric	Bacterio.	Chemistry	Agarose Gel
		Flasks	Virology	Biology	
		PROG. 01	PROG. 02	PROG. 03	PROG. 04
PREWASH TIME 1	0 TO 30 MN	1	2	2	2
FILLING	1 / 2 / 3 / 4 / 5 *	4	4	4	5
PREWASH 1 TEMPERATURE	0 TO 95 °C	0	0	0	90
PREWASH 1 DETERGENT	0 TO 9999 ml	30	30	30	120
OPTION : PREWASH 1 DETERGENT 2	0 TO 9999 ml	0	0	0	0
OPTION : PREWASH 1 NEUTRALIZATION	0 TO 9999 ml	15	15	15	60
PREWASH TIME 2	0 TO 30 MN	0	0	0	1
FILLING	1 / 2 / 3 / 4 / 5 *	/	/	/	4
PREWASH 2 TEMPERATURE	0 TO 95 °C	/	/	/	0
PREWASH 2 DETERGENT	0 TO 9999 ml	/	/	/	0
OPTION : PREWASH 2 DETERGENT 2	0 TO 9999 ml	/	/	/	0
OPTION : PREWASH 2 NEUTRALIZATION	0 TO 9999 ml	/	/	/	0
PREWASH TIME 3	0 TO 30 MN	0	0	0	0
FILLING	1 / 2 / 3 / 4 / 5 *	/	/	/	/
PREWASH 3 TEMPERATURE	0 TO 95 °C	/	/	/	/
PREWASH 3 DETERGENT	0 TO 9999 ml	/	/	/	/
OPTION : PREWASH 3 DETERGENT 2	0 TO 9999 ml	/	/	/	/
OPTION : PREWASH 3 NEUTRALIZATION	0 TO 9999 ml	/	/	/	/
WASH TIME	0 TO 30 MN	4	4	2	2
FILLING	1 / 2 / 3 / 4 / 5 *	5	5	5	5
WASH TEMPERATURE	0 TO 95 °C	50	85	70	90
WASH DETERGENT	0 TO 9999 ml	120	120	120	150
OPTION : WASH DETERGENT 2	0 TO 9999 ml	0	0	0	0
OPTION : WASH NEUTRALIZATION	0 TO 9999 ml	60	60	60	75
RINSE TIME A	0 TO 30 MN	1	1	1	1
FILLING	1 / 2 / 3 / 4 / 5 *	1	1	1	1
RINSE A TEMPERATURE	0 TO 95 °C	/	/	/	/
RINSE A	0 TO 9	/	/	2	2
ACID RINSE TIME	0 TO 30 MN	2	2	2	2
FILLING	1 / 2 / 3 / 4 / 5 *	1	1	1	1
ACID RINSE TEMPERATURE	0 TO 95 °C	0	0	0	0
NEUTRALIZING ACID	0 TO 9999 ml	120	120	120	120
OPTION : ACID RINSE NEUTRALIZATION	0 TO 9999 ml	240	240	240	240
243RINSE TIME B	0 TO 30 MN	1	1	1	1
FILLING	1 / 2 / 3 / 4 / 5 *	1	1	1	1
RINSE B TEMPERATURE	0 TO 95 °C	/	/	/	/
RINSE B	0 TO 9	/	2	/	/
RINSE. TIME 1	0 TO 30 MN	1	0	1	1
FILLING	1 / 2 / 3 / 4 / 5 *	2	/	2	2
RINSE 1 TEMPERATURE	0 TO 95 °C	/	/	/	/
RINSE TIME 2	0 TO 30 MN	0	0	1	0
FILLING	1 / 2 / 3 / 4 / 5 *	/	/	2	/
RINSE 2 TIME TEMPERATURE	0 TO 95 °C	/	/	/	/
RINSE TIME 3	0 TO 30 MN	0	0	0	0
FILLING	1 / 2 / 3 / 4 / 5 *	/	/	/	/
RINSE 3 TEMPERATURE	0 TO 95 °C	/	/	/	/
RINSE TIME 4	0 TO 30 MN	0	0	0	0
FILLING	1 / 2 / 3 / 4 / 5 *	/	/	/	/
RINSE 4 TEMPERATURE	0 TO 95 °C	/	/	/	/
FINAL RINSE TIME	0 TO 30 MN	1	1	1	1
FILLING	1 / 2 / 3 / 4 / 5 *	2	2	2	2
FINAL RINSE TEMPERATURE	0 TO 95 °C	50	80	80	80
DRYING TIME	0 TO 30 MN	10	25	25	25
DRYING	Adjust. / Maxi	Adjust.	Maxi	Maxi	Maxi
COOLING	0 TO 30 MN	0	5	5	5

1.10 1400 LX - FACTORY PROGRAMMED CYCLE - STANDARD

* Please refer page 73 for the water's name

SEQUENCES	POSSIBILITIES	Volumetric	Bacterio.	Chemistry	Agarose Gel
		Flasks	Virology	Biology	
		PROG. 01	PROG. 02	PROG. 03	PROG. 04
PREWASH TIME 1	0 TO 30 MN	1	2	2	2
FILLING	1 / 2 / 3 / 4 / 5 *	1	1	1	3
PREWASH 1 TEMPERATURE	0 TO 95 °C	0	0	0	90
PREWASH 1 DETERGENT	0 TO 9999 ml	40	40	40	160
OPTION : PREWASH 1 DETERGENT 2	0 TO 9999 ml	0	0	0	0
OPTION : PREWASH 1 NEUTRALIZATION	0 TO 9999 ml	20	20	20	80
PREWASH TIME 2	0 TO 30 MN	0	0	0	1
FILLING	1 / 2 / 3 / 4 / 5 *	/	/	/	1
PREWASH 2 TEMPERATURE	0 TO 95 °C	/	/	/	0
PREWASH 2 DETERGENT	0 TO 9999 ml	/	/	/	0
OPTION : PREWASH 2 DETERGENT 2	0 TO 9999 ml	/	/	/	0
OPTION : PREWASH 2 NEUTRALIZATION	0 TO 9999 ml	/	/	/	0
PREWASH TIME 3	0 TO 30 MN	0	0	0	0
FILLING	1 / 2 / 3 / 4 / 5 *	/	/	/	/
PREWASH 3 TEMPERATURE	0 TO 95 °C	/	/	/	/
PREWASH 3 DETERGENT	0 TO 9999 ml	/	/	/	/
OPTION : PREWASH 3 DETERGENT 2	0 TO 9999 ml	/	/	/	/
OPTION : PREWASH 3 NEUTRALIZATION	0 TO 9999 ml	/	/	/	/
WASH TIME	0 TO 30 MN	4	4	2	2
FILLING	1 / 2 / 3 / 4 / 5 *	3	3	3	3
WASH TEMPERATURE	0 TO 95 °C	50	85	70	90
WASH DETERGENT	0 TO 9999 ml	160	160	160	200
OPTION : WASH DETERGENT 2	0 TO 9999 ml	0	0	0	0
OPTION : WASH NEUTRALIZATION	0 TO 9999 ml	80	80	80	100
RINSE TIME A	0 TO 30 MN	1	1	1	1
FILLING	1 / 2 / 3 / 4 / 5 *	1	1	1	1
RINSE A TEMPERATURE	0 TO 95 °C	/	/	/	/
RINSE A	0 TO 9	/	/	2	2
ACID RINSE TIME	0 TO 30 MN	2	2	2	2
FILLING	1 / 2 / 3 / 4 / 5 *	1	1	1	1
ACID RINSE TEMPERATURE	0 TO 95 °C	0	0	0	0
NEUTRALIZING ACID	0 TO 9999 ml	160	160	160	160
OPTION : ACID RINSE NEUTRALIZATION	0 TO 9999 ml	320	320	320	320
RINSE TIME B	0 TO 30 MN	1	1	1	1
FILLING	1 / 2 / 3 / 4 / 5 *	1	1	1	1
RINSE B TEMPERATURE	0 TO 95 °C	/	/	/	/
RINSE B	0 TO 9	/	2	/	/
RINSE TIME 1	0 TO 30 MN	1	0	1	1
FILLING	1 / 2 / 3 / 4 / 5 *	2	/	2	2
RINSE 1 TEMPERATURE	0 TO 95 °C	/	/	/	/
RINSE TIME 2	0 TO 30 MN	0	0	1	0
FILLING	1 / 2 / 3 / 4 / 5 *	/	/	2	/
RINSE 2 TIME TEMPERATURE	0 TO 95 °C	/	/	/	/
RINSE TIME 3	0 TO 30 MN	0	0	0	0
FILLING	1 / 2 / 3 / 4 / 5 *	/	/	/	/
RINSE 3 TEMPERATURE	0 TO 95 °C	/	/	/	/
RINSE TIME 4	0 TO 30 MN	0	0	0	0
FILLING	1 / 2 / 3 / 4 / 5 *	/	/	/	/
RINSE 4 TEMPERATURE	0 TO 95 °C	/	/	/	/
FINAL RINSE TIME	0 TO 30 MN	1	1	1	1
FILLING	1 / 2 / 3 / 4 / 5 *	2	2	2	2
FINAL RINSE TEMPERATURE	0 TO 95 °C	50	80	80	80
DRYING TIME	0 TO 30 MN	10	25	25	25
DRYING	Adjust. / Maxi	Adjust.	Maxi	Maxi	Maxi
COOLING	0 TO 30 MN	0	5	5	5

1.11 1400 LX - FACTORY PROGRAMMED CYCLE – SOFTENER OPTION

* Please refer page 73 for the water's name

SEQUENCES	POSSIBILITIES	Volumetric	Bacterio.	Chemistry	Agarose Gel
		Flasks	Virology	Biology	
		PROG. 01	PROG. 02	PROG. 03	PROG. 04
PREWASH TIME 1	0 TO 30 MN	1	2	2	2
FILLING	1 / 2 / 3 / 4 / 5 *	4	4	4	5
PREWASH 1 TEMPERATURE	0 TO 95 °C	0	0	0	90
PREWASH 1 DETERGENT	0 TO 9999 ml	40	40	40	160
OPTION : PREWASH 1 DETERGENT 2	0 TO 9999 ml	0	0	0	0
OPTION : PREWASH 1 NEUTRALIZATION	0 TO 9999 ml	20	20	20	80
PREWASH TIME 2	0 TO 30 MN	0	0	0	1
FILLING	1 / 2 / 3 / 4 / 5 *	/	/	/	4
PREWASH 2 TEMPERATURE	0 TO 95 °C	/	/	/	0
PREWASH 2 DETERGENT	0 TO 9999 ml	/	/	/	0
OPTION : PREWASH 2 DETERGENT 2	0 TO 9999 ml	/	/	/	0
OPTION : PREWASH 2 NEUTRALIZATION	0 TO 9999 ml	/	/	/	0
PREWASH TIME 3	0 TO 30 MN	0	0	0	0
FILLING	1 / 2 / 3 / 4 / 5 *	/	/	/	/
PREWASH 3 TEMPERATURE	0 TO 95 °C	/	/	/	/
PREWASH 3 DETERGENT	0 TO 9999 ml	/	/	/	/
OPTION : PREWASH 3 DETERGENT 2	0 TO 9999 ml	/	/	/	/
OPTION : PREWASH 3 NEUTRALIZATION	0 TO 9999 ml	/	/	/	/
WASH TIME	0 TO 30 MN	4	4	2	2
FILLING	1 / 2 / 3 / 4 / 5 *	5	5	5	5
WASH TEMPERATURE	0 TO 95 °C	50	85	70	90
WASH DETERGENT	0 TO 9999 ml	160	160	160	200
OPTION : WASH DETERGENT 2	0 TO 9999 ml	0	0	0	0
OPTION : WASH NEUTRALIZATION	0 TO 9999 ml	80	80	80	100
RINSE TIME A	0 TO 30 MN	1	1	1	1
FILLING	1 / 2 / 3 / 4 / 5 *	1	1	1	1
RINSE A TEMPERATURE	0 TO 95 °C	/	/	/	/
RINSE A	0 TO 9	/	/	2	2
ACID RINSE TIME	0 TO 30 MN	2	2	2	2
FILLING	1 / 2 / 3 / 4 / 5 *	1	1	1	1
ACID RINSE TEMPERATURE	0 TO 95 °C	0	0	0	0
NEUTRALIZING ACID	0 TO 9999 ml	160	160	160	160
OPTION : ACID RINSE NEUTRALIZATION	0 TO 9999 ml	320	320	320	320
RINSE TIME B	0 TO 30 MN	1	1	1	1
FILLING	1 / 2 / 3 / 4 / 5 *	1	1	1	1
RINSE B TEMPERATURE	0 TO 95 °C	/	/	/	/
RINSE B	0 TO 9	/	2	/	/
RINSE TIME 1	0 TO 30 MN	1	0	1	1
FILLING	1 / 2 / 3 / 4 / 5 *	2	/	2	2
RINSE 1 TEMPERATURE	0 TO 95 °C	/	/	/	/
RINSE TIME 2	0 TO 30 MN	0	0	1	0
FILLING	1 / 2 / 3 / 4 / 5 *	/	/	2	/
RINSE 2 TIME TEMPERATURE	0 TO 95 °C	/	/	/	/
RINSE TIME 3	0 TO 30 MN	0	0	0	0
FILLING	1 / 2 / 3 / 4 / 5 *	/	/	/	/
RINSE 3 TEMPERATURE	0 TO 95 °C	/	/	/	/
RINSE TIME 4	0 TO 30 MN	0	0	0	0
FILLING	1 / 2 / 3 / 4 / 5 *	/	/	/	/
RINSE 4 TEMPERATURE	0 TO 95 °C	/	/	/	/
FINAL RINSE TIME	0 TO 30 MN	1	1	1	1
FILLING	1 / 2 / 3 / 4 / 5 *	2	2	2	2
FINAL RINSE TEMPERATURE	0 TO 95 °C	50	80	80	80
DRYING TIME	0 TO 30 MN	10	25	25	25
DRYING	Adjust. / Maxi	Adjust.	Maxi	Maxi	Maxi
COOLING	0 TO 30 MN	0	5	5	5

1.12 1400 LXP - FACTORY PROGRAMMED CYCLE – STANDARD

* Please refer page 73 for the water's name

SEQUENCES	POSSIBILITIES	Volumetric	Bacterio.	Chemistry	Agarose Gel
		Flasks	Virology	Biology	
		PROG. 01	PROG. 02	PROG. 03	PROG. 04
PREWASH TIME 1	0 TO 30 MN	1	2	2	2
FILLING	1 / 2 / 3 / 4 / 5 *	1	1	1	3
PREWASH 1 TEMPERATURE	0 TO 95 °C	0	0	0	90
PREWASH 1 DETERGENT	0 TO 9999 ml	40	40	40	160
OPTION : PREWASH 1 DETERGENT 2	0 TO 9999 ml	0	0	0	0
OPTION : PREWASH 1 NEUTRALIZATION	0 TO 9999 ml	20	20	20	80
PREWASH TIME 2	0 TO 30 MN	0	0	0	1
FILLING	1 / 2 / 3 / 4 / 5 *	/	/	/	1
PREWASH 2 TEMPERATURE	0 TO 95 °C	/	/	/	0
PREWASH 2 DETERGENT	0 TO 9999 ml	/	/	/	0
OPTION : PREWASH 2 DETERGENT 2	0 TO 9999 ml	/	/	/	0
OPTION : PREWASH 2 NEUTRALIZATION	0 TO 9999 ml	/	/	/	0
PREWASH TIME 3	0 TO 30 MN	0	0	0	0
FILLING	1 / 2 / 3 / 4 / 5 *	/	/	/	/
PREWASH 3 TEMPERATURE	0 TO 95 °C	/	/	/	/
PREWASH 3 DETERGENT	0 TO 9999 ml	/	/	/	/
OPTION : PREWASH 3 DETERGENT 2	0 TO 9999 ml	/	/	/	/
OPTION : PREWASH 3 NEUTRALIZATION	0 TO 9999 ml	/	/	/	/
WASH TIME	0 TO 30 MN	4	4	2	2
FILLING	1 / 2 / 3 / 4 / 5 *	3	3	3	3
WASH TEMPERATURE	0 TO 95 °C	50	85	70	90
WASH DETERGENT	0 TO 9999 ml	160	160	160	200
OPTION : WASH DETERGENT 2	0 TO 9999 ml	0	0	0	0
OPTION : WASH NEUTRALIZATION	0 TO 9999 ml	80	80	80	100
RINSE TIME A	0 TO 30 MN	1	1	1	1
FILLING	1 / 2 / 3 / 4 / 5 *	1	1	1	1
RINSE A TEMPERATURE	0 TO 95 °C	/	/	/	/
RINSE A	0 TO 9	/	/	2	2
ACID RINSE TIME	0 TO 30 MN	2	2	2	2
FILLING	1 / 2 / 3 / 4 / 5 *	1	1	1	1
ACID RINSE TEMPERATURE	0 TO 95 °C	0	0	0	0
NEUTRALIZING ACID	0 TO 9999 ml	160	160	160	160
OPTION : ACID RINSE NEUTRALIZATION	0 TO 9999 ml	320	320	320	320
RINSE TIME B	0 TO 30 MN	1	1	1	1
FILLING	1 / 2 / 3 / 4 / 5 *	1	1	1	1
RINSE B TEMPERATURE	0 TO 95 °C	/	/	/	/
RINSE B	0 TO 9	/	2	/	/
RINSE TIME 1	0 TO 30 MN	1	0	1	1
FILLING	1 / 2 / 3 / 4 / 5 *	2	/	2	2
RINSE 1 TEMPERATURE	0 TO 95 °C	/	/	/	/
RINSE TIME 2	0 TO 30 MN	0	0	1	0
FILLING	1 / 2 / 3 / 4 / 5 *	/	/	2	/
RINSE 2 TIME TEMPERATURE	0 TO 95 °C	/	/	/	/
RINSE TIME 3	0 TO 30 MN	0	0	0	0
FILLING	1 / 2 / 3 / 4 / 5 *	/	/	/	/
RINSE 3 TEMPERATURE	0 TO 95 °C	/	/	/	/
RINSE TIME 4	0 TO 30 MN	0	0	0	0
FILLING	1 / 2 / 3 / 4 / 5 *	/	/	/	/
RINSE 4 TEMPERATURE	0 TO 95 °C	/	/	/	/
FINAL RINSE TIME	0 TO 30 MN	1	1	1	1
FILLING	1 / 2 / 3 / 4 / 5 *	2	2	2	2
FINAL RINSE TEMPERATURE	0 TO 95 °C	50	80	80	80
DRYING TIME	0 TO 30 MN	10	25	25	25
DRYING	0 TO 110°C	60	60	60	90
COOLING	0 TO 30 MN	5	5	5	5

1.13 1400 LXP - FACTORY PROGRAMMED CYCLE – SOFTENER OPTION

* Please refer page 73 for the water's name

SEQUENCES	POSSIBILITIES	Volumetric	Bacterio.	Chemistry	Agarose Gel
		Flasks	Virology	Biology	
		PROG. 01	PROG. 02	PROG. 03	PROG. 04
PREWASH TIME 1	0 TO 30 MN	1	2	2	2
FILLING	1 / 2 / 3 / 4 / 5 *	4	4	4	5
PREWASH 1 TEMPERATURE	0 TO 95 °C	0	0	0	90
PREWASH 1 DETERGENT	0 TO 9999 ml	40	40	40	160
OPTION : PREWASH 1 DETERGENT 2	0 TO 9999 ml	0	0	0	0
OPTION : PREWASH 1 NEUTRALIZATION	0 TO 9999 ml	20	20	20	80
PREWASH TIME 2	0 TO 30 MN	0	0	0	1
FILLING	1 / 2 / 3 / 4 / 5 *	/	/	/	4
PREWASH 2 TEMPERATURE	0 TO 95 °C	/	/	/	0
PREWASH 2 DETERGENT	0 TO 9999 ml	/	/	/	0
OPTION : PREWASH 2 DETERGENT 2	0 TO 9999 ml	/	/	/	0
OPTION : PREWASH 2 NEUTRALIZATION	0 TO 9999 ml	/	/	/	0
PREWASH TIME 3	0 TO 30 MN	0	0	0	0
FILLING	1 / 2 / 3 / 4 / 5 *	/	/	/	/
PREWASH 3 TEMPERATURE	0 TO 95 °C	/	/	/	/
PREWASH 3 DETERGENT	0 TO 9999 ml	/	/	/	/
OPTION : PREWASH 3 DETERGENT 2	0 TO 9999 ml	/	/	/	/
OPTION : PREWASH 3 NEUTRALIZATION	0 TO 9999 ml	/	/	/	/
WASH TIME	0 TO 30 MN	4	4	2	2
FILLING	1 / 2 / 3 / 4 / 5 *	5	5	5	5
WASH TEMPERATURE	0 TO 95 °C	50	85	70	90
WASH DETERGENT	0 TO 9999 ml	160	160	160	200
OPTION : WASH DETERGENT 2	0 TO 9999 ml	0	0	0	0
OPTION : WASH NEUTRALIZATION	0 TO 9999 ml	80	80	80	100
RINSE TIME A	0 TO 30 MN	1	1	1	1
FILLING	1 / 2 / 3 / 4 / 5 *	1	1	1	1
RINSE A TEMPERATURE	0 TO 95 °C	/	/	/	/
RINSE A	0 TO 9	/	/	2	2
ACID RINSE TIME	0 TO 30 MN	2	2	2	2
FILLING	1 / 2 / 3 / 4 / 5 *	1	1	1	1
ACID RINSE TEMPERATURE	0 TO 95 °C	0	0	0	0
NEUTRALIZING ACID	0 TO 9999 ml	160	160	160	160
OPTION : ACID RINSE NEUTRALIZATION	0 TO 9999 ml	320	320	320	320
RINSE TIME B	0 TO 30 MN	1	1	1	1
FILLING	1 / 2 / 3 / 4 / 5 *	1	1	1	1
RINSE B TEMPERATURE	0 TO 95 °C	/	/	/	/
RINSE B	0 TO 9	/	2	/	/
RINSE. TIME 1	0 TO 30 MN	1	0	1	1
FILLING	1 / 2 / 3 / 4 / 5 *	2	/	2	2
RINSE 1 TEMPERATURE	0 TO 95 °C	/	/	/	/
RINSE TIME 2	0 TO 30 MN	0	0	1	0
FILLING	1 / 2 / 3 / 4 / 5 *	/	/	2	/
RINSE 2 TIME TEMPERATURE	0 TO 95 °C	/	/	/	/
RINSE TIME 3	0 TO 30 MN	0	0	0	0
FILLING	1 / 2 / 3 / 4 / 5 *	/	/	/	/
RINSE 3 TEMPERATURE	0 TO 95 °C	/	/	/	/
RINSE TIME 4	0 TO 30 MN	0	0	0	0
FILLING	1 / 2 / 3 / 4 / 5 *	/	/	/	/
RINSE 4 TEMPERATURE	0 TO 95 °C	/	/	/	/
FINAL RINSE TIME	0 TO 30 MN	1	1	1	1
FILLING	1 / 2 / 3 / 4 / 5 *	2	2	2	2
FINAL RINSE TEMPERATURE	0 TO 95 °C	50	80	80	80
DRYING TIME	0 TO 30 MN	10	25	25	25
DRYING	0 TO 110°C	60	60	60	90
COOLING	0 TO 30 MN	5	5	5	5

1.14 1600 LXP - FACTORY PROGRAMMED CYCLE - STANDARD

* Please refer page 73 for the water's name

SEQUENCES	POSSIBILITIES	Volumetric	Bacterio.	Chemistry	Agarose Gel
		Flasks	Virology	Biology	
		PROG. 01	PROG. 02	PROG. 03	PROG. 04
PREWASH TIME 1	0 TO 30 MN	1	2	2	2
FILLING	1 / 2 / 3 / 4 / 5 *	1	1	1	3
PREWASH 1 TEMPERATURE	0 TO 95 °C	0	0	0	90
PREWASH 1 DETERGENT	0 TO 9999 ml	60	60	60	240
OPTION : PREWASH 1 DETERGENT 2	0 TO 9999 ml	0	0	0	0
OPTION : PREWASH 1 NEUTRALIZATION	0 TO 9999 ml	30	30	30	120
PREWASH TIME 2	0 TO 30 MN	0	0	0	1
FILLING	1 / 2 / 3 / 4 / 5 *	/	/	/	1
PREWASH 2 TEMPERATURE	0 TO 95 °C	/	/	/	0
PREWASH 2 DETERGENT	0 TO 9999 ml	/	/	/	0
OPTION : PREWASH 2 DETERGENT 2	0 TO 9999 ml	/	/	/	0
OPTION : PREWASH 2 NEUTRALIZATION	0 TO 9999 ml	/	/	/	0
PREWASH TIME 3	0 TO 30 MN	0	0	0	0
FILLING	1 / 2 / 3 / 4 / 5 *	/	/	/	/
PREWASH 3 TEMPERATURE	0 TO 95 °C	/	/	/	/
PREWASH 3 DETERGENT	0 TO 9999 ml	/	/	/	/
OPTION : PREWASH 3 DETERGENT 2	0 TO 9999 ml	/	/	/	/
OPTION : PREWASH 3 NEUTRALIZATION	0 TO 9999 ml	/	/	/	/
WASH TIME	0 TO 30 MN	4	4	2	2
FILLING	1 / 2 / 3 / 4 / 5 *	3	3	3	3
WASH TEMPERATURE	0 TO 95 °C	50	85	70	90
WASH DETERGENT	0 TO 9999 ml	240	240	240	300
OPTION : WASH DETERGENT 2	0 TO 9999 ml	0	0	0	0
OPTION : WASH NEUTRALIZATION	0 TO 9999 ml	120	120	120	150
RINSE TIME A	0 TO 30 MN	1	1	1	1
FILLING	1 / 2 / 3 / 4 / 5 *	1	1	1	1
RINSE A TEMPERATURE	0 TO 95 °C	/	/	/	/
RINSE A	0 TO 9	/	/	2	2
ACID RINSE TIME	0 TO 30 MN	2	2	2	2
FILLING	1 / 2 / 3 / 4 / 5 *	1	1	1	1
ACID RINSE TEMPERATURE	0 TO 95 °C	0	0	0	0
NEUTRALIZING ACID	0 TO 9999 ml	240	240	240	240
OPTION : ACID RINSE NEUTRALIZATION	0 TO 9999 ml	480	480	480	480
RINSE TIME B	0 TO 30 MN	1	1	1	1
FILLING	1 / 2 / 3 / 4 / 5 *	1	1	1	1
RINSE B TEMPERATURE	0 TO 95 °C	/	/	/	/
RINSE B	0 TO 9	/	2	/	/
RINSE TIME 1	0 TO 30 MN	1	0	1	1
FILLING	1 / 2 / 3 / 4 / 5 *	2	/	2	2
RINSE 1 TEMPERATURE	0 TO 95 °C	/	/	/	/
RINSE TIME 2	0 TO 30 MN	0	0	1	0
FILLING	1 / 2 / 3 / 4 / 5 *	/	/	2	/
RINSE 2 TIME TEMPERATURE	0 TO 95 °C	/	/	/	/
RINSE TIME 3	0 TO 30 MN	0	0	0	0
FILLING	1 / 2 / 3 / 4 / 5 *	/	/	/	/
RINSE 3 TEMPERATURE	0 TO 95 °C	/	/	/	/
RINSE TIME 4	0 TO 30 MN	0	0	0	0
FILLING	1 / 2 / 3 / 4 / 5 *	/	/	/	/
RINSE 4 TEMPERATURE	0 TO 95 °C	/	/	/	/
FINAL RINSE TIME	0 TO 30 MN	1	1	1	1
FILLING	1 / 2 / 3 / 4 / 5 *	2	2	2	2
FINAL RINSE TEMPERATURE	0 TO 95 °C	50	80	80	80
DRYING TIME	0 TO 30 MN	10	25	25	25
DRYING	0 TO 110°C	60	60	60	90
COOLING	0 TO 30 MN	5	5	5	5

1.15 1600 LXP - FACTORY PROGRAMMED CYCLE – SOFTENER OPTION

* Please refer page 73 for the water's name

SEQUENCES	POSSIBILITIES	Volumetric	Bacterio.	Chemistry	Agarose Gel
		Flasks	Virology	Biology	
		PROG. 01	PROG. 02	PROG. 03	PROG. 04
PREWASH TIME 1	0 TO 30 MN	1	2	2	2
FILLING	1 / 2 / 3 / 4 / 5 *	4	4	4	5
PREWASH 1 TEMPERATURE	0 TO 95 °C	0	0	0	90
PREWASH 1 DETERGENT	0 TO 9999 ml	60	60	60	240
OPTION : PREWASH 1 DETERGENT 2	0 TO 9999 ml	0	0	0	0
OPTION : PREWASH 1 NEUTRALIZATION	0 TO 9999 ml	30	30	30	120
PREWASH TIME 2	0 TO 30 MN	0	0	0	1
FILLING	1 / 2 / 3 / 4 / 5 *	/	/	/	4
PREWASH 2 TEMPERATURE	0 TO 95 °C	/	/	/	0
PREWASH 2 DETERGENT	0 TO 9999 ml	/	/	/	0
OPTION : PREWASH 2 DETERGENT 2	0 TO 9999 ml	/	/	/	0
OPTION : PREWASH 2 NEUTRALIZATION	0 TO 9999 ml	/	/	/	0
PREWASH TIME 3	0 TO 30 MN	0	0	0	0
FILLING	1 / 2 / 3 / 4 / 5 *	/	/	/	/
PREWASH 3 TEMPERATURE	0 TO 95 °C	/	/	/	/
PREWASH 3 DETERGENT	0 TO 9999 ml	/	/	/	/
OPTION : PREWASH 3 DETERGENT 2	0 TO 9999 ml	/	/	/	/
OPTION : PREWASH 3 NEUTRALIZATION	0 TO 9999 ml	/	/	/	/
WASH TIME	0 TO 30 MN	4	4	2	2
FILLING	1 / 2 / 3 / 4 / 5 *	5	5	5	5
WASH TEMPERATURE	0 TO 95 °C	50	85	70	90
WASH DETERGENT	0 TO 9999 ml	240	240	240	300
OPTION : WASH DETERGENT 2	0 TO 9999 ml	0	0	0	0
OPTION : WASH NEUTRALIZATION	0 TO 9999 ml	120	120	120	150
RINSE TIME A	0 TO 30 MN	1	1	1	1
FILLING	1 / 2 / 3 / 4 / 5 *	1	1	1	1
RINSE A TEMPERATURE	0 TO 95 °C	/	/	/	/
RINSE A	0 TO 9	/	/	2	2
ACID RINSE TIME	0 TO 30 MN	2	2	2	2
FILLING	1 / 2 / 3 / 4 / 5 *	1	1	1	1
ACID RINSE TEMPERATURE	0 TO 95 °C	0	0	0	0
NEUTRALIZING ACID	0 TO 9999 ml	240	240	240	240
OPTION : ACID RINSE NEUTRALIZATION	0 TO 9999 ml	480	480	480	480
RINSE TIME B	0 TO 30 MN	1	1	1	1
FILLING	1 / 2 / 3 / 4 / 5 *	1	1	1	1
RINSE B TEMPERATURE	0 TO 95 °C	/	/	/	/
RINSE B	0 TO 9	/	2	/	/
RINSE TIME 1	0 TO 30 MN	1	0	1	1
FILLING	1 / 2 / 3 / 4 / 5 *	2	/	2	2
RINSE 1 TEMPERATURE	0 TO 95 °C	/	/	/	/
RINSE TIME 2	0 TO 30 MN	0	0	1	0
FILLING	1 / 2 / 3 / 4 / 5 *	/	/	2	/
RINSE 2 TIME TEMPERATURE	0 TO 95 °C	/	/	/	/
RINSE TIME 3	0 TO 30 MN	0	0	0	0
FILLING	1 / 2 / 3 / 4 / 5 *	/	/	/	/
RINSE 3 TEMPERATURE	0 TO 95 °C	/	/	/	/
RINSE TIME 4	0 TO 30 MN	0	0	0	0
FILLING	1 / 2 / 3 / 4 / 5 *	/	/	/	/
RINSE 4 TEMPERATURE	0 TO 95 °C	/	/	/	/
FINAL RINSE TIME	0 TO 30 MN	1	1	1	1
FILLING	1 / 2 / 3 / 4 / 5 *	2	2	2	2
FINAL RINSE TEMPERATURE	0 TO 95 °C	50	80	80	80
DRYING TIME	0 TO 30 MN	10	25	25	25
DRYING	0 TO 110°C	60	60	60	90
COOLING	0 TO 30 MN	5	5	5	5

1.16 1800 LXA - FACTORY PROGRAMMED CYCLE - STANDARD

* Please refer page 73 for the water's name

SEQUENCES	POSSIBILITIES	Volumetric	Bacterio.	Chemistry	Agarose Gel
		Flasks	Virology	Biology	
		PROG. 01	PROG. 02	PROG. 03	PROG. 04
PREWASH TIME 1	0 TO 30 MN	1	2	2	2
FILLING	1 / 2 / 3 / 4 / 5 *	1	1	1	3
PREWASH 1 TEMPERATURE	0 TO 95 °C	0	0	0	90
PREWASH 1 DETERGENT	0 TO 9999 ml	100	100	100	400
OPTION : PREWASH 1 DETERGENT 2	0 TO 9999 ml	0	0	0	0
OPTION : PREWASH 1 NEUTRALIZATION	0 TO 9999 ml	50	50	50	200
PREWASH TIME 2	0 TO 30 MN	0	0	0	1
FILLING	1 / 2 / 3 / 4 / 5 *	/	/	/	1
PREWASH 2 TEMPERATURE	0 TO 95 °C	/	/	/	0
PREWASH 2 DETERGENT	0 TO 9999 ml	/	/	/	0
OPTION : PREWASH 2 DETERGENT 2	0 TO 9999 ml	/	/	/	0
OPTION : PREWASH 2 NEUTRALIZATION	0 TO 9999 ml	/	/	/	0
PREWASH TIME 3	0 TO 30 MN	0	0	0	0
FILLING	1 / 2 / 3 / 4 / 5 *	/	/	/	/
PREWASH 3 TEMPERATURE	0 TO 95 °C	/	/	/	/
PREWASH 3 DETERGENT	0 TO 9999 ml	/	/	/	/
OPTION : PREWASH 3 DETERGENT 2	0 TO 9999 ml	/	/	/	/
OPTION : PREWASH 3 NEUTRALIZATION	0 TO 9999 ml	/	/	/	/
WASH TIME	0 TO 30 MN	4	4	2	2
FILLING	1 / 2 / 3 / 4 / 5 *	3	3	3	3
WASH TEMPERATURE	0 TO 95 °C	50	85	70	90
WASH DETERGENT	0 TO 9999 ml	400	400	400	500
OPTION : WASH DETERGENT 2	0 TO 9999 ml	0	0	0	0
OPTION : WASH NEUTRALIZATION	0 TO 9999 ml	200	200	200	250
RINSE TIME A	0 TO 30 MN	1	1	1	1
FILLING	1 / 2 / 3 / 4 / 5 *	1	1	1	1
RINSE A TEMPERATURE	0 TO 95 °C	/	/	/	/
RINSE A	0 TO 9	/	/	2	2
ACID RINSE TIME	0 TO 30 MN	2	2	2	2
FILLING	1 / 2 / 3 / 4 / 5 *	1	1	1	1
ACID RINSE TEMPERATURE	0 TO 95 °C	0	0	0	0
NEUTRALIZING ACID	0 TO 9999 ml	400	400	400	400
OPTION : ACID RINSE NEUTRALIZATION	0 TO 9999 ml	800	800	800	800
RINSE TIME B	0 TO 30 MN	1	1	1	1
FILLING	1 / 2 / 3 / 4 / 5 *	1	1	1	1
RINSE B TEMPERATURE	0 TO 95 °C	/	/	/	/
RINSE B	0 TO 9	/	2	/	/
RINSE TIME 1	0 TO 30 MN	1	0	1	1
FILLING	1 / 2 / 3 / 4 / 5 *	2	/	2	2
RINSE 1 TEMPERATURE	0 TO 95 °C	/	/	/	/
RINSE TIME 2	0 TO 30 MN	0	0	1	0
FILLING	1 / 2 / 3 / 4 / 5 *	/	/	2	/
RINSE 2 TIME TEMPERATURE	0 TO 95 °C	/	/	/	/
RINSE TIME 3	0 TO 30 MN	0	0	0	0
FILLING	1 / 2 / 3 / 4 / 5 *	/	/	/	/
RINSE 3 TEMPERATURE	0 TO 95 °C	/	/	/	/
RINSE TIME 4	0 TO 30 MN	0	0	0	0
FILLING	1 / 2 / 3 / 4 / 5 *	/	/	/	/
RINSE 4 TEMPERATURE	0 TO 95 °C	/	/	/	/
FINAL RINSE TIME	0 TO 30 MN	1	1	1	1
FILLING	1 / 2 / 3 / 4 / 5 *	2	2	2	2
FINAL RINSE TEMPERATURE	0 TO 95 °C	50	80	80	80
DRYING TIME	0 TO 30 MN	10	25	25	25
DRYING	0 TO 110°C	60	60	60	90
COOLING	0 TO 30 MN	5	5	5	5

1.17 1800 LXA - FACTORY PROGRAMMED CYCLE – SOFTENER OPTION

* Please refer page 73 for the water's name

SEQUENCES	POSSIBILITIES	Volumetric	Bacterio.	Chemistry	Agarose Gel
		Flasks	Virology	Biology	
		PROG. 01	PROG. 02	PROG. 03	PROG. 04
PREWASH TIME 1	0 TO 30 MN	1	2	2	2
FILLING	1 / 2 / 3 / 4 / 5 *	4	4	4	5
PREWASH 1 TEMPERATURE	0 TO 95 °C	0	0	0	90
PREWASH 1 DETERGENT	0 TO 9999 ml	100	100	100	400
OPTION : PREWASH 1 DETERGENT 2	0 TO 9999 ml	0	0	0	0
OPTION : PREWASH 1 NEUTRALIZATION	0 TO 9999 ml	50	50	50	200
PREWASH TIME 2	0 TO 30 MN	0	0	0	1
FILLING	1 / 2 / 3 / 4 / 5 *	/	/	/	4
PREWASH 2 TEMPERATURE	0 TO 95 °C	/	/	/	0
PREWASH 2 DETERGENT	0 TO 9999 ml	/	/	/	0
OPTION : PREWASH 2 DETERGENT 2	0 TO 9999 ml	/	/	/	0
OPTION : PREWASH 2 NEUTRALIZATION	0 TO 9999 ml	/	/	/	0
PREWASH TIME 3	0 TO 30 MN	0	0	0	0
FILLING	1 / 2 / 3 / 4 / 5 *	/	/	/	/
PREWASH 3 TEMPERATURE	0 TO 95 °C	/	/	/	/
PREWASH 3 DETERGENT	0 TO 9999 ml	/	/	/	/
OPTION : PREWASH 3 DETERGENT 2	0 TO 9999 ml	/	/	/	/
OPTION : PREWASH 3 NEUTRALIZATION	0 TO 9999 ml	/	/	/	/
WASH TIME	0 TO 30 MN	4	4	2	2
FILLING	1 / 2 / 3 / 4 / 5 *	5	5	5	5
WASH TEMPERATURE	0 TO 95 °C	50	85	70	90
WASH DETERGENT	0 TO 9999 ml	400	400	400	500
OPTION : WASH DETERGENT 2	0 TO 9999 ml	0	0	0	0
OPTION : WASH NEUTRALIZATION	0 TO 9999 ml	200	200	200	250
RINSE TIME A	0 TO 30 MN	1	1	1	1
FILLING	1 / 2 / 3 / 4 / 5 *	1	1	1	1
RINSE A TEMPERATURE	0 TO 95 °C	/	/	/	/
RINSE A	0 TO 9	/	/	2	2
ACID RINSE TIME	0 TO 30 MN	2	2	2	2
FILLING	1 / 2 / 3 / 4 / 5 *	1	1	1	1
ACID RINSE TEMPERATURE	0 TO 95 °C	0	0	0	0
NEUTRALIZING ACID	0 TO 9999 ml	400	400	400	400
OPTION : ACID RINSE NEUTRALIZATION	0 TO 9999 ml	800	800	800	800
RINSE TIME B	0 TO 30 MN	1	1	1	1
FILLING	1 / 2 / 3 / 4 / 5 *	1	1	1	1
RINSE B TEMPERATURE	0 TO 95 °C	/	/	/	/
RINSE B	0 TO 9	/	2	/	/
RINSE TIME 1	0 TO 30 MN	1	0	1	1
FILLING	1 / 2 / 3 / 4 / 5 *	2	/	2	2
RINSE 1 TEMPERATURE	0 TO 95 °C	/	/	/	/
RINSE TIME 2	0 TO 30 MN	0	0	1	0
FILLING	1 / 2 / 3 / 4 / 5 *	/	/	2	/
RINSE 2 TIME TEMPERATURE	0 TO 95 °C	/	/	/	/
RINSE TIME 3	0 TO 30 MN	0	0	0	0
FILLING	1 / 2 / 3 / 4 / 5 *	/	/	/	/
RINSE 3 TEMPERATURE	0 TO 95 °C	/	/	/	/
RINSE TIME 4	0 TO 30 MN	0	0	0	0
FILLING	1 / 2 / 3 / 4 / 5 *	/	/	/	/
RINSE 4 TEMPERATURE	0 TO 95 °C	/	/	/	/
FINAL RINSE TIME	0 TO 30 MN	1	1	1	1
FILLING	1 / 2 / 3 / 4 / 5 *	2	2	2	2
FINAL RINSE TEMPERATURE	0 TO 95 °C	50	80	80	80
DRYING TIME	0 TO 30 MN	10	25	25	25
DRYING	0 TO 110°C	60	60	60	90
COOLING	0 TO 30 MN	5	5	5	5

2. USER CYCLE PROGRAMMING TABLE



IT IS NOT RECOMMEND TO SET WASH PROGRAMS AT MAXIMUM VALUES FOR TIME AND TEMPERATURE AS THIS WILL RESULT IN REDUCED EQUIPMENT LIFE AND INCREASED MAINTENANCE FREQUENCY OF EQUIPMENT.

DO NOT SET BACK TO BACK HIGH TEMPERATURE 85°C TO 95°C HEATING PHASES. DOING SO CAN INCREASE THE TEMPERATURE INSIDE THE MACHINE AND MAY ACTIVATE SOME OVERHEATING DEVICES. TO PREVENT THIS FROM OCCURRING, WE RECOMMEND TO PROGRAM A MINIMUM 30 SECOND COLD PHASE BETWEEN TWO HEATING PHASES.

IF YOU WISH TO CREATE A CUSTOM WASH PROGRAM, PLEASE REFER TO THE FACTORY DEFAULT PROGRAMS FOR EXAMPLES OF TYPICAL TIMES AND TEMPERATURES.

YOU MAY ALSO CONTACT YOUR GETINGE REPRESENTATIVE FOR ADVICE ON CREATING WASH PROGRAMS.

IT IS NOT RECOMMENDED TO INSTALL THE MACHINE IN A PLACE EXCEEDING 30°C. IT WILL HELP TO INCREASE DURING THE CYCLE THE TEMPERATURE INSIDE THE MACHINE. IT WILL RESULT IN REDUCED EQUIPMENT LIFE AND INCREASED MAINTENANCE FREQUENCY OF EQUIPMENT

* Please refer page 73 for the water's name

SEQUENCES	POSSIBILITIES	PROG.	PROG.	PROG.	PROG.
PREWASH TIME 1	0 TO 30 MN				
FILLING	1 / 2 / 3 / 4 / 5 *				
PREWASH 1 TEMPERATURE	0 TO 95 °C				
PREWASH 1 DETERGENT	0 TO 9999 ml				
OPTION : PREWASH 1 DETERGENT 2	0 TO 9999 ml				
OPTION : PREWASH 1 NEUTRALIZATION	0 TO 9999 ml				
PREWASH TIME 2	0 TO 30 MN				
FILLING	1 / 2 / 3 / 4 / 5 *				
PREWASH 2 TEMPERATURE	0 TO 95 °C				
PREWASH 2 DETERGENT	0 TO 9999 ml				
OPTION : PREWASH 2 DETERGENT 2	0 TO 9999 ml				
OPTION : PREWASH 2 NEUTRALIZATION	0 TO 9999 ml				
PREWASH TIME 3	0 TO 30 MN				
FILLING	1 / 2 / 3 / 4 / 5 *				
PREWASH 3 TEMPERATURE	0 TO 95 °C				
PREWASH 3 DETERGENT	0 TO 9999 ml				
OPTION : PREWASH 3 DETERGENT 2	0 TO 9999 ml				
OPTION : PREWASH 3 NEUTRALIZATION	0 TO 9999 ml				
WASH TIME	0 TO 30 MN				
FILLING	1 / 2 / 3 / 4 / 5 *				
WASH TEMPERATURE	0 TO 95 °C				
WASH DETERGENT	0 TO 9999 ml				
OPTION : WASH DETERGENT 2	0 TO 9999 ml				
OPTION : WASH NEUTRALIZATION	0 TO 9999 ml				
RINSE TIME A	0 TO 30 MN				
FILLING	1 / 2 / 3 / 4 / 5 *				
RINSE A TEMPERATURE	0 TO 95 °C				
RINSE A	0 TO 9				
ACID RINSE TIME	0 TO 30 MN				
FILLING	1 / 2 / 3 / 4 / 5 *				
ACID RINSE TEMPERATURE	0 TO 95 °C				
NEUTRALIZING ACID	0 TO 9999 ml				
OPTION : ACID RINSE NEUTRALIZATION	0 TO 9999 ml				
RINSE TIME B	0 TO 30 MN				
FILLING	1 / 2 / 3 / 4 / 5 *				
RINSE B TEMPERATURE	0 TO 95 °C				
RINSE B	0 TO 9				
RINSE TIME 1	0 TO 30 MN				
FILLING	1 / 2 / 3 / 4 / 5 *				
RINSE 1 TEMPERATURE	0 TO 95 °C				
RINSE TIME 2	0 TO 30 MN				
FILLING	1 / 2 / 3 / 4 / 5 *				
RINSE 2 TIME TEMPERATURE	0 TO 95 °C				
RINSE TIME 3	0 TO 30 MN				
FILLING	1 / 2 / 3 / 4 / 5 *				
RINSE 3 TEMPERATURE	0 TO 95 °C				
RINSE TIME 4	0 TO 30 MN				
FILLING	1 / 2 / 3 / 4 / 5 *				
RINSE 4 TEMPERATURE	0 TO 95 °C				
FINAL RINSE TIME	0 TO 30 MN				
FILLING	1 / 2 / 3 / 4 / 5 *				
FINAL RINSE TEMPERATURE	0 TO 95 °C				
DRYING TIME	0 TO 30 MN				
DRYING	0 TO 110°C				
COOLING	0 TO 30 MN				

LANCER
GETINGE GROUP

Getinge Infection Control AB
P O Box 69, SE-305 05 Getinge, Sweden
Phone: +46 10 335 00 00
info@getinge.com

www.getinge.com

Legal Manufacturer:
Getinge Lancer
30 boulevard de l'Industrie
31170 Tournefeuille, France
Phone: +33 5 61 15 11 11
Fax: +33 5 61 15 16 16

GETINGE GROUP

Getinge Group is a leading global provider of products and systems that contribute to quality enhancement and cost efficiency within healthcare and life sciences. We operate under the three brands of ArjoHuntleigh, Getinge and Maquet. ArjoHuntleigh focuses on patient mobility and wound management solutions. Getinge provides solutions for infection control within healthcare and contamination prevention within life sciences. Maquet specializes in solutions, therapies and products for surgical interventions, interventional cardiology and intensive care.
