



Getinge Lancer Ultima labware washing systems

Freestanding series

This document is intended to provide information to a North American audience.

GETINGE 



Professional cleaning results

– integrated systems,
repeatable results

From quality control to general laboratory research, Getinge Lancer Ultima series washers meet space and budget requirements in laboratories performing a range of critical applications where clean labware is essential.

Typical applications include analytical chemistry, quality control, pharmaceutical and environmental science laboratories, wastewater treatment, food and beverage analysis, public health and consumer product testing facilities.

The exclusive Prolux programmable microprocessor controller commands a full range of prewash, wash, rinse and drying functions through simple touchscreen menus on all Ultima series washers. The convenience of five preset programs for light to heavy loads simplifies operation, while more complex programs can be customized whenever needed to meet specific applications.



Getinge Lancer Ultima model 1300 LX freestanding labware washer, shown with accessory loading rack, sold separately.



Quiet Operation.
Noise reduction design minimizes sound for quiet operation.



Cool Surface.
High-performance insulation contains heat and limits energy consumption.



Prolux programmable microprocessor controller with intuitive touchscreen user interface.

Control screen shows actual cycle performance, alarm events. Data is captured for documentation and communication.

Preset or user programmed cycles are fully adjustable to permit multiple combinations of prewash, wash, rinse, acid rinse, purified final rinse, HEPA filtered forced air drying, controlled duration, temperature and more.

High efficiency powerful fluid circulation with direct fluid path and rear manifold connections deliver optimal pressure and flow rates.

Chamber walls made in durable AISI 316L stainless steel material.

Injector jet performance provides inside out wash and rinse functions.

Stainless steel top and bottom spray arms and multiple levels of injection washing ensure thorough spray coverage.

Two integrated automatic chemical dosing pumps are standard on all models. Convenient on-board chemical storage beneath chamber saves space.



View-In-Process Window

An optional View-In-Process (VIP) window includes an interior LED light for visual verification of the interior load during the cycle.

Getinge Lancer Ultima model 1400 LXP freestanding labware washer, shown with accessory loading rack, sold separately.

Meeting a variety of laboratory needs

The Getinge Lancer Ultima series freestanding washers include five high-performance models that offer a range of labware loading options using baskets, injector racks or combination racks for the best high capacity processing of multiple labware types in the industry.



910 LX / 1300 LX features	1400 LXP / 1600 LXP features
Prolux control interface	Prolux Plus control interface
Manual fold down door	Manual fold down door
Forced-air drying, injectors, HEPA filtered	Forced-air drying, injectors, HEPA filtered

Capacity comparison					
Model	Volume	Interior (W x H x D)	Positions	Wash levels	Configurations
910 LX	5.7 cu. ft. (160 L)	21.1" x 21.4" x 20.5" (535 x 544 x 520 mm)	3	2	3
1300 LX	6.4 cu. ft. (180 L)	21.1" x 25.4" x 20.5" (535 x 644 x 520 mm)	4	3	5
1400 LXP	10.7 cu. ft. (304 L)	24.6" x 30.4" x 24.8" (626 x 773 x 629 mm)	4	3	6
1600 LXP	14.4 cu. ft. (408 L)	27.7" x 33.8" x 26.7" (703 x 858 x 678 mm)	5	4	12
1600 LXP/HE	17.7 cu. ft. (500 L)	27.7" x 41.3" x 26.7" (703 x 1048 x 678 mm)	5	4	12

Models shown (left to right) 910 LX, 1300 LX, 1400 LXP, 1600 LXP and 1600 LXP/HE.

Small spaces, impressive capacity

910 LX

Drawings display front and side of unit, with door swing allowance.

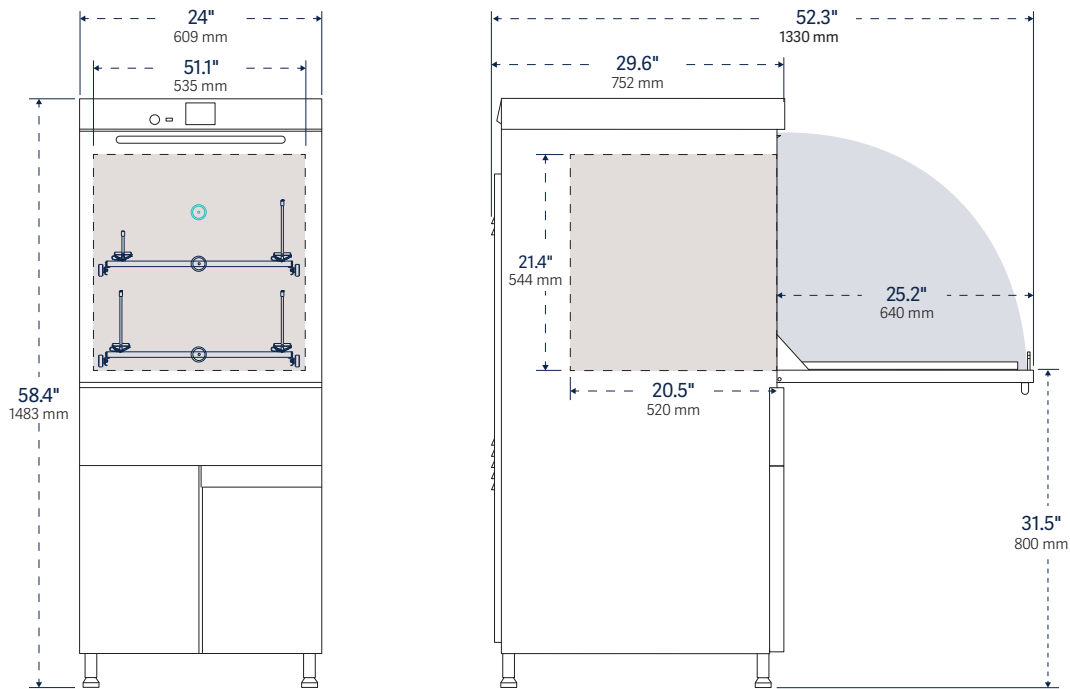

Model	Interior dimensions W x H x D	Exterior dimensions W x H x D	Water per fill* gal (L)	Programs presets	custom
910 LX	21.1" x 21.4" x 20.5" 535 x 544 x 520 mm	24" x 58.4" x 29.6" 609 x 1483 x 752 mm	3.4 (13)	5	35

* Total water consumption per fill based on reservoir sump and all fluid path fill volumes, care should be taken when evaluating comparative water consumption claims.



3.5" **910 LX**
3.5" Prolux Control Interface,
Standard Monitoring.



Stainless steel top and bottom spray arms on all models ensure complete washing and rinsing of glassware exterior and interior of large mouthed glassware.



910 LX
Wash load configurations

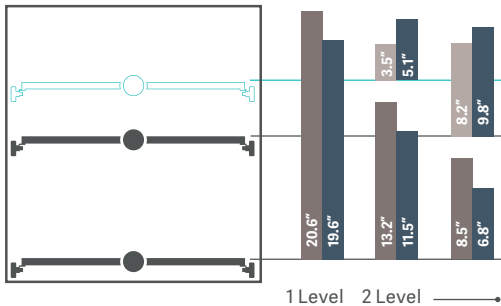

PST Basic basket
 IXC / IXL injection racks (long / short jets)

PSBT Basic basket with spray arm

Sound Level
<60 dB(A)

Model	Cycle function				Chemical dosing				Net weight Empty lb (kg)
	Wash temp. max. °F (°C)	Rinse purified water	Rinse acid	Drying	Automatic pumps	On-Board chemical storage	Level sensors	Water softener	
910 LX	203°F (95°C)	■	■	Forced-air chamber and injectors; HEPA filtered	2 (max 3)	■	2 (max 3)	□	315 (143)

■ / □ Standard / optional features

Compact footprint, lasting impression

1300 LX

Drawings display front and side of unit, with door swing allowance.

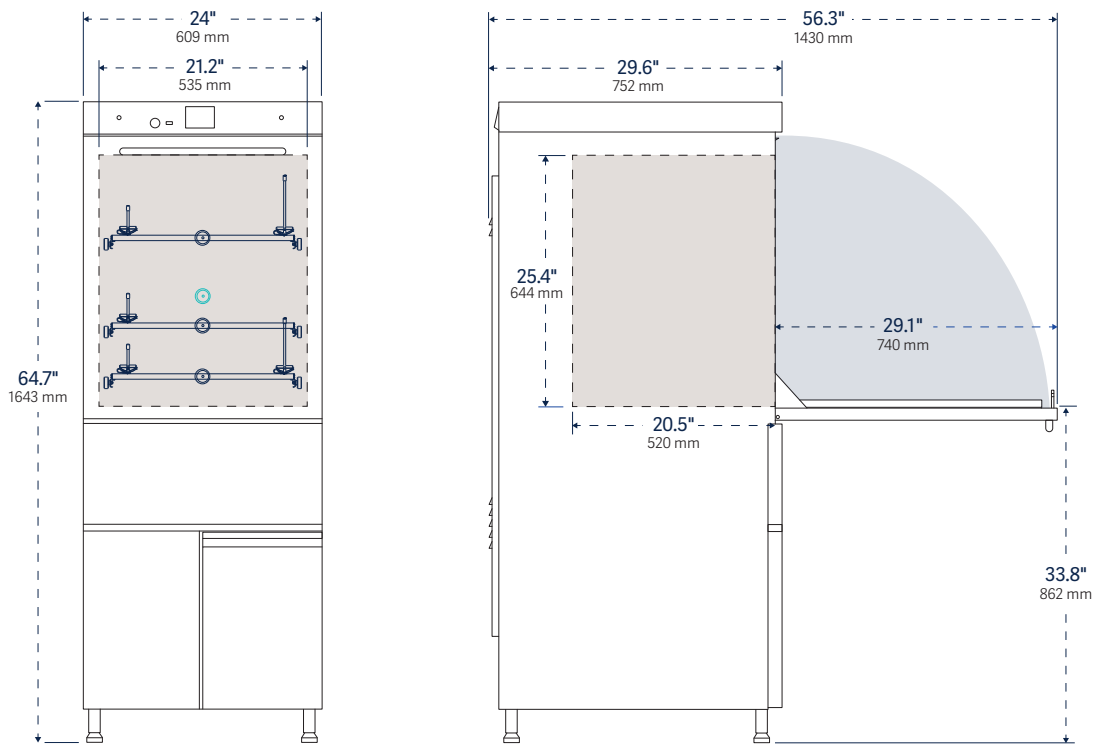

Model	Interior dimensions W x H x D	Exterior dimensions W x H x D	Water per fill* gal (L)	Programs presets	custom
1300 LX	21.1" x 25.4" x 20.5" 535 x 644 x 520 mm	24" x 64.7" x 29.6" 609 x 1643 x 752 mm	4 (15)	5	35

* Total water consumption per fill based on reservoir sump and all fluid path fill volumes, care should be taken when evaluating comparative water consumption claims.



3.5" **1300 LX**
3.5" Prolux Control Interface,
Standard Monitoring.



For maximum connectivity, all Ultima series washers include a USB port, conveniently located on the front panel for easy access and transfer of cleaning process documentation, including cycle parameters, cycle number, date and time, phase duration, temperature for each phase, and detergent and acid intake.



1300 LX
Wash load configurations

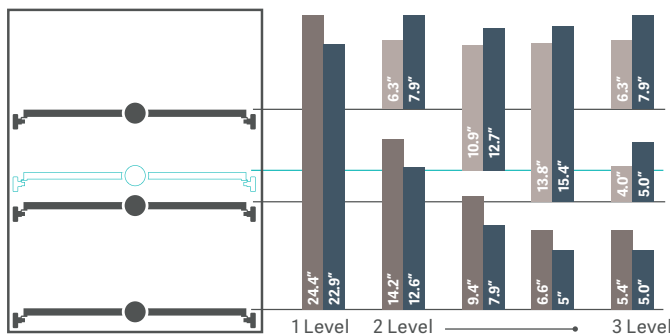

Sound Level
<60 dB(A)

- PST Basic basket
- PSBT Basic basket with spray arm
- IXC / IXL injection racks (long / short jets)

Model	Cycle function				Chemical dosing				Net weight
	Wash temp. max. °F (°C)	Rinse purified water	Rinse acid	Drying	Automatic pumps	On-Board chemical storage	Level sensors	Water softener	Empty lb (kg)
1300 LX	203°F (95°C)	■	■	Forced-air chamber and injectors; HEPA filtered	2 (max 3)	■	2 (max 3)	□	319 (145)

■ / □ Standard / optional features

Space efficiency, multi-level loading

1400 LXP

Drawings display front and side of unit, with door swing allowance.

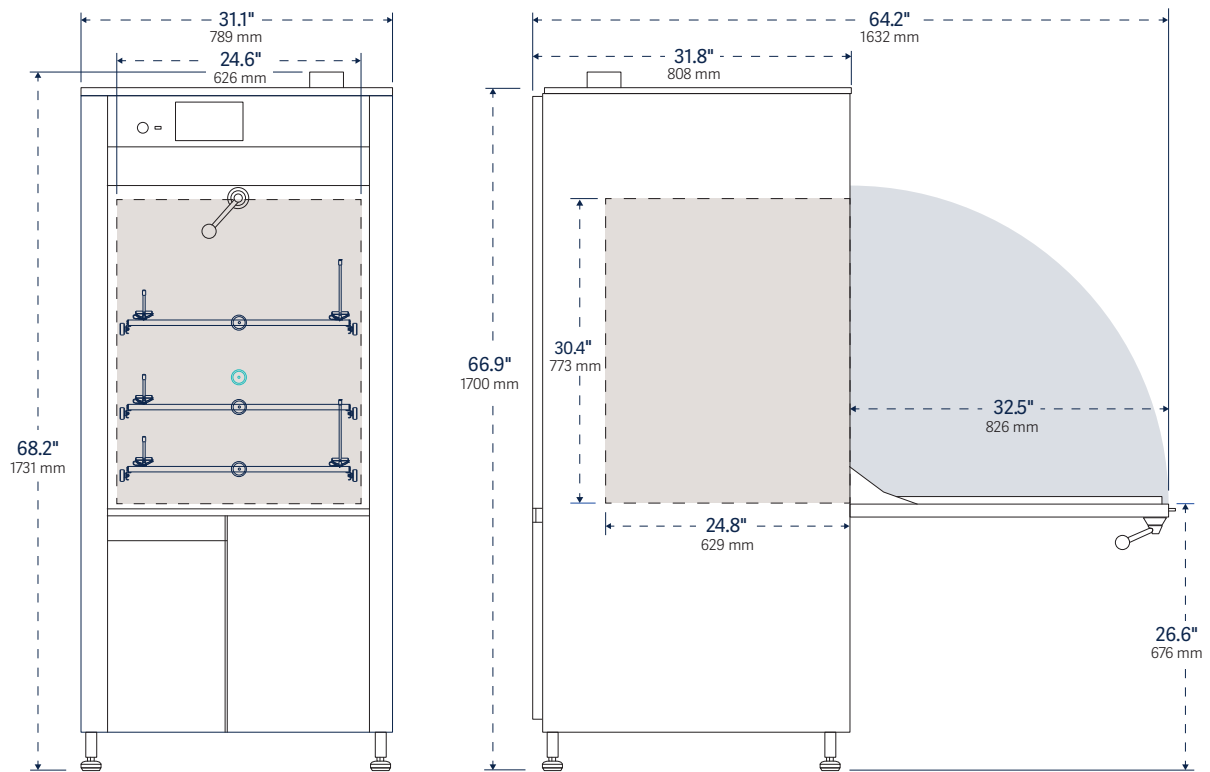

Model	Interior dimensions	Exterior dimensions	Water per fill*	Programs	
	W x H x D	W x H x D		presets	custom
1400 LXP	24.6" x 30.4" x 24.8" 626 x 773 x 629 mm	31.1" x 68.2" x 31.8" 789 x 1731 x 808 mm	5.2-6.6 (20-25)	5	35

* Total water consumption per fill based on reservoir sump and all fluid path fill volumes, care should be taken when evaluating comparative water consumption claims.



1400 LXP
7" Prolux Plus Control Interface,
Enhanced Monitoring.

All Ultima series labware washers feature telescopic runners with advanced design for smooth and easy function as well as innovative rack stops for safety and ergonomics.



1400 LXP
Wash load configurations

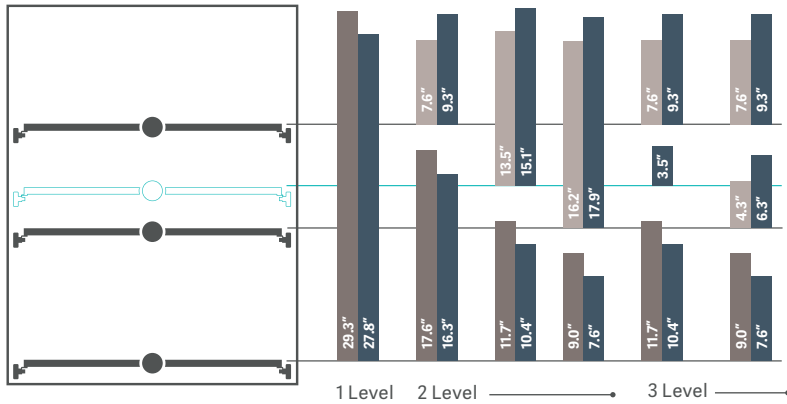

■ PST Basic basket ■ IXC / IXL injection racks (long / short jets)
■ PSBT Basic basket with spray arm



Sound Level
<69 dB(A)

Model	Cycle function				Chemical dosing				Net weight
	Wash temp. max. °F (°C)	Rinse purified water	Rinse acid	Drying	Automatic pumps	On-Board chemical storage	Level sensors	Water softener	Empty lb (kg)
1400 LXP	203°F (95°C)	■	■	Forced-air chamber and injectors; HEPA filtered	2 (max 4)	■	2 (max 4)	□	469 (213)

■ / □ Standard / optional features

Maximum flexibility

1600 LXP

Drawings display front and side of unit, with door swing allowance.

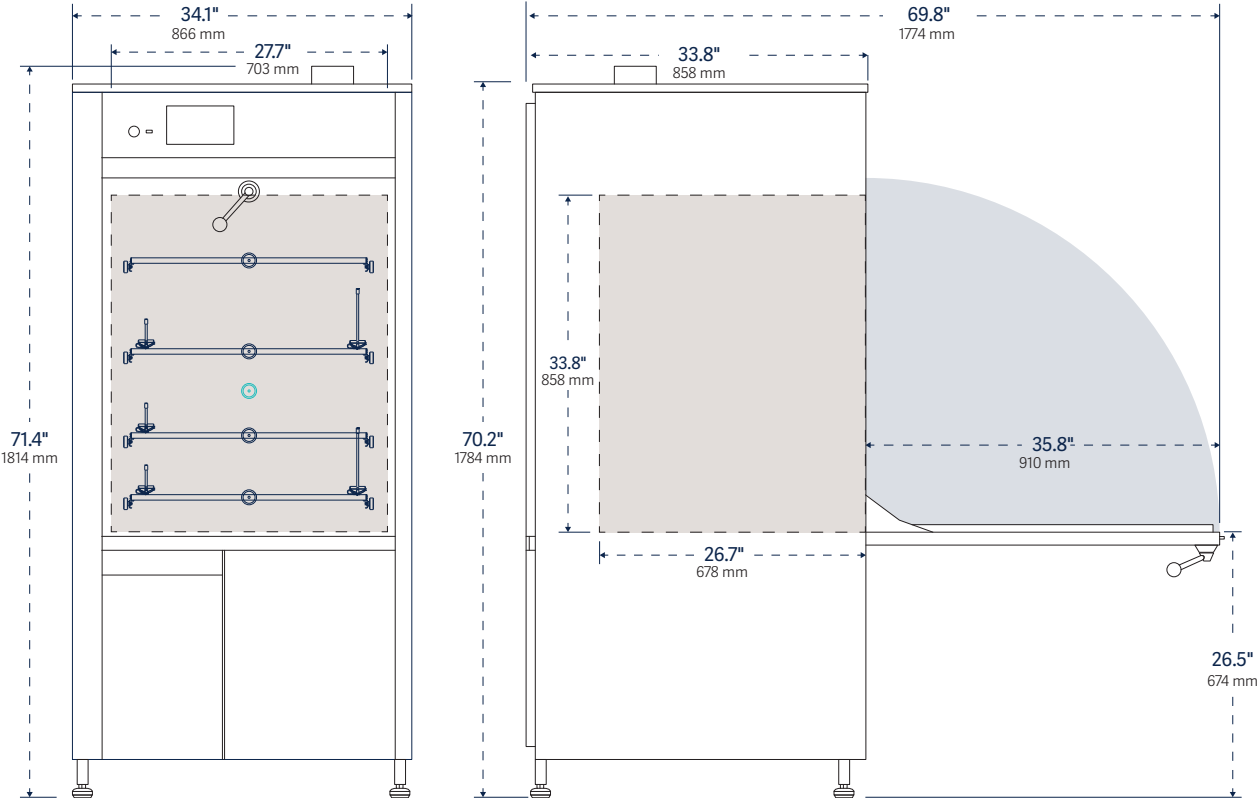

Model	Interior dimensions W x H x D	Exterior dimensions W x H x D	Water per fill* gal (L)	Programs presets	custom
1600 LXP	27.7" x 33.8" x 26.7" 703 x 858 x 678 mm	34.1" x 71.4" x 33.8" 866 x 1814 x 858 mm	7.9-9.2 (30-35)	5	35

* Total water consumption per fill based on reservoir sump and all fluid path fill volumes, care should be taken when evaluating comparative water consumption claims.



1600 LXP
7" Prolux Plus Control Interface,
Enhanced Monitoring.



1600 LXP
Wash load configurations.

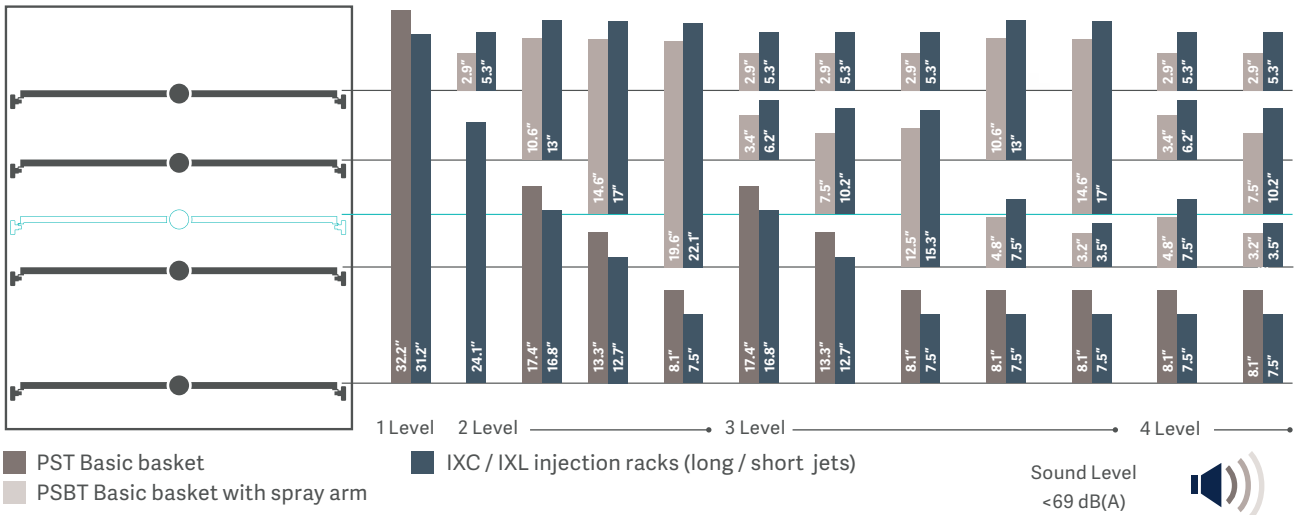

Model	Cycle function				Chemical dosing				Net weight Empty lb (kg)
	Wash temp. max. °F (°C)	Rinse purified water	Rinse acid	Drying	Automatic pumps	On-Board chemical storage	Level sensors	Water softener	
1600 LXP	203°F (95°C)	■	■	Forced-air chamber and injectors; HEPA filtered	2 (max 4)	■	2 (max 4)	□	474 (215)

■ / □ Standard / optional features

High throughput

1600 LXP/HE

Drawings display front and side of unit, with door swing allowance.

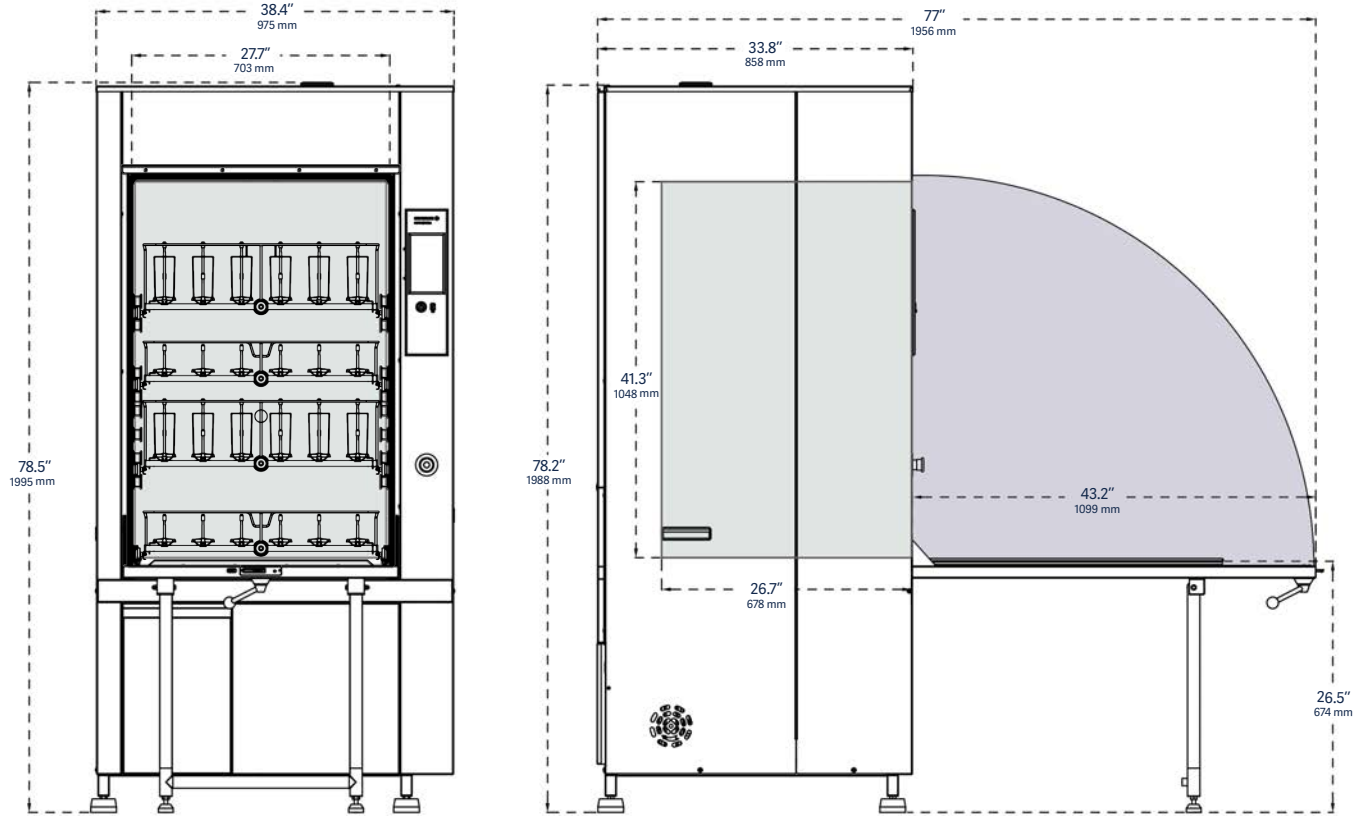

Model	Interior dimensions W x H x D	Exterior dimensions W x H x D	Water per fill* gal (L)	Programs	
				presets	custom
1600 LXP/HE	27.7" x 41.3" x 26.7" 703 x 1048 x 678 mm	38.4" x 78.5" x 33.8" 975 x 1995 x 858 mm	7.9-9.2 (30-35)	5	35

* Total water consumption per fill based on reservoir sump and all fluid path fill volumes, care should be taken when evaluating comparative water consumption claims.



1600 LXP/HE

High throughput chamber with a total loading capacity of 17,7 cu.ft (500 liters)

Include door jacks for safe loading and unloading



1600 LXP/HE

Wash load configurations.

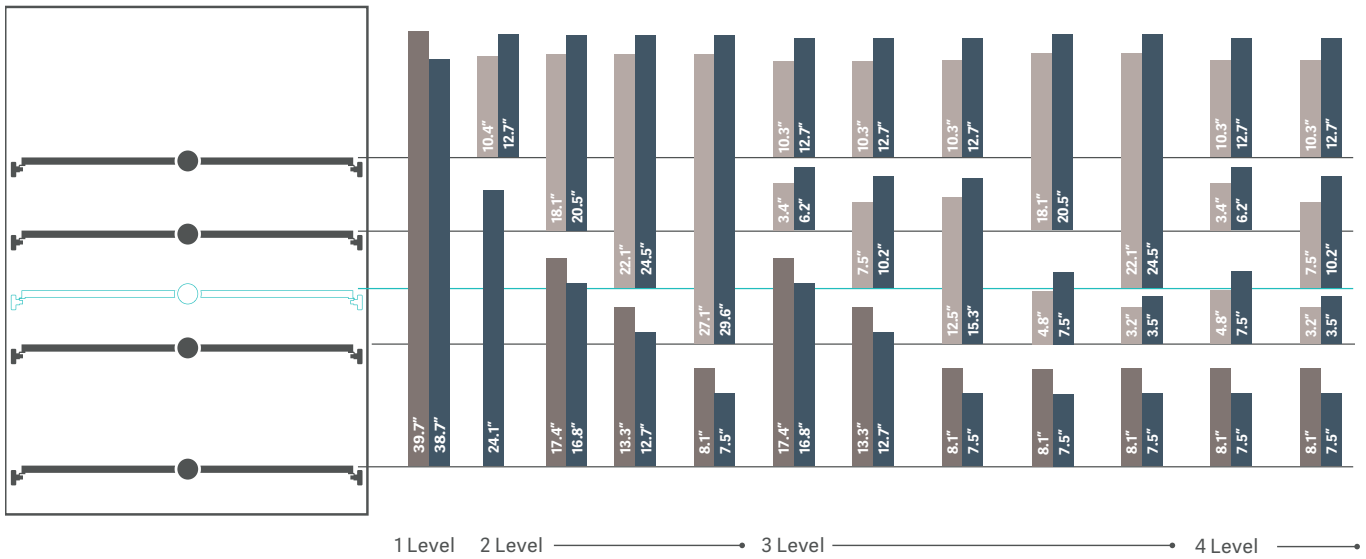

- PST Basic basket
- PSBT Basic basket with spray arm

- IXC / IXL injection racks (long / short jets)

Sound Level <69 dB(A)

Model	Cycle function			Drying	Chemical dosing			Water softener	Net weight Empty lb (kg)
	Wash temp. max. °F (°C)	Rinse purified water	Rinse acid		Automatic pumps	On-Board chemical storage	Level sensors		

1600 LXP/HE	203°F (95°C)	■	■	Forced-air chamber and injectors; HEPA filtered	2 (max 4)	■	2 (max 4)	□	529 (240)
--------------------	--------------	---	---	---	-----------	---	-----------	---	-----------

■ / □ Standard / optional features

Repeatable results

– with reliability, safety and high throughput

Ergonomic Loading Configurations.

Unlike oversized washers with less efficient loading patterns, Getinge Lancer Ultima series freestanding labware washers are designed for high-density loading and the most effective use of available interior space. This efficiency maximizes throughput and reduces capital investments, operating costs and the amount of dedicated lab space needed.

- Telescoping load-bearing rails permit extension of racks for easy loading with or without an optional trolley.
- All racks are interchangeable between wash levels thereby minimizing the need for additional accessories.
- Racks for Getinge Lancer Ultima series undercounter models and freestanding models 910 LX, 1300 LX are interchangeable.
- The fold-down door creates a platform for proper rack positioning and more comfortable loading and unloading.

Cleaning performance and safety.

Operating systems are designed for performance, efficiency and high throughput.

- An automatic door lock prevents door opening during active cycles and protects the user from heat and chemical exposure.
- Top and bottom stainless steel spray arms are pressurized to provide exterior coverage to the labware.
- Injector rack manifold connections are located at the rear for proper alignment and the most efficient pressure and flow.
- Washing temperature can be set to a maximum of 203°F (95°C) if required for more difficult soils.
- Automatic Peristaltic pumps are self-contained for accurate and repeatable dosing of detergents or acids required by each cycle.
- Multiple DI rinses can be programmed to eliminate interior and exterior spotting.



The front-loading door folds down to create an ergonomically stable platform for proper rack positioning and easier loading, eliminating the need for a trolley to load or unload glassware.

Alarms and monitoring

- The high resolution touchscreen color display is easy to read from a distance.
- The intuitive graphic user interface creates a series of visual performance indicators such as active program, time remaining, warning, alarm and cycle completed functions.
- Five preset programs permit one touch operation. Additional cycles are programmed from the graphic user interface.
- An integrated USB port allows easy front panel access for process tracking and data logging. Optional process record printouts available through USB or Ethernet ports are managed by the Prolux controller.

Hydraulic design

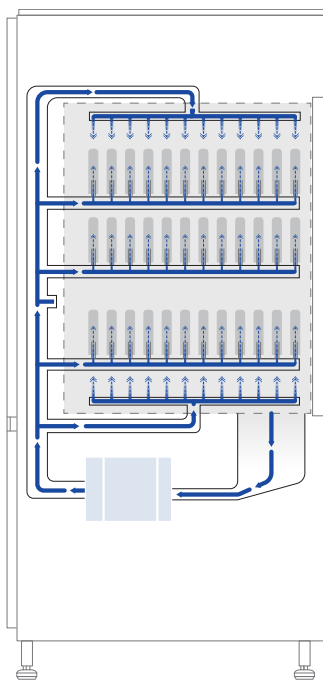

The Getinge Lancer Ultima hydraulic design optimizes pressure and flow for efficient performance at all wash levels.

The combination of a high-performance recirculation pump, straight-line fluid path and center-mounted rack interface assures maximum water flow through spray arms and injectors.

Washer pump is protected from debris by a stainless steel sump screen. The screen lifts out without tools for easy cleaning.

Model 1400 LXP, waterflow.

Construction

The sump, spray arms, interior chamber walls and door are fabricated from 316L stainless steel to resist aggressive chemicals and residues.

- Exterior 304L stainless steel panels resist corrosion, simplify cleaning and protect electrical and plumbing components.
- Double-wall insulated assembly confines heat loss and minimizes noise.
- Easy access stainless steel chamber filters extend washer life by protecting pumps and interior plumbing from debris.
- A compact liquid sump and direct fluid path minimizes water volume per fill, lowers overall consumption per cycle and improves sustainability throughout the useful life.

View-In-Process



An optional dual pane View-In-Process (VIP) window includes an interior LED light for visual verification of the interior load during the cycle. The light is activated by the On/Off switch through the Prolux controller. Tempered safety glass provides excellent sound and heat abatement and enhances operator safety. Factory installed, specify when ordering.

Model 910 LX:

13.7" (348 mm) H x 6.8" (173 mm) W

Models 1300 LX / 1400 LXP / 1600 LXP:

20" (508 mm) H x 6.8" (173 mm) W

* VIP window not available on model 1600LXP/HE

Simple, flexible, documented, trusted.

Prolux controller.

The all new 3.5" Prolux and 7" Prolux Plus controllers are based on a high-performance PLC microprocessor designed for simplicity, one-touch start, real-time status indicators and intuitive programming options that permit customization over the range of washer operations.

Both the Prolux and Prolux Plus controller integrate a suite of menu screens that support digital functions from cycle selection, process monitoring, warning advisories, audible and visual alarms, system communications and data capture.

Operation

- Screen menus and graphic user interfaces are designed to simplify setup and operations including active programs, remaining time, warnings, alarms and cycle complete notifications.
- Five preset programs are factory loaded for one-touch control of most routine applications.
- When additional cycle programs are desired, parameters can be changed through secure access to the administration screen where an intuitive graphic user interface displays all options.

Communication and connectivity

- A front-panel USB port simplifies direct connection to peripheral devices for cycle tracking and data capture. The port is covered by a protective hood.
- A real-time process record is printed if optional printer is installed.
- Multiple data ports include Ethernet and RS422 connectors.
- Optional printer documents cycle performance, warnings and alarms.



The Prolux and Prolux Plus (above) controllers include a touch-screen interface with a common icon directory that permits scrolling access to primary screens from the same menu. A set of sub-menu screens display additional icon directories specific to the screen functions.

910 LX / 1300 LX



- 3.5" Prolux color touchscreen interface
- 320 x 240 pixel resolution display
- Five presets
- Additional custom program options

1400 LXP / 1600 LXP / 1600 LXP/HE



- 7" Prolux Plus color touchscreen interface
- 800 x 480 pixel resolution display
- Five presets
- Additional custom program options



The Prolux control interface features an intuitive menu of primary and secondary screens, configured with icons, to simplify access to all functions. The touchscreen is easily managed with a gloved hand.

Programming

Programmable cycle parameter selections include:

- **Prewash.** Up to 3 prewashes, 0 to 30 minutes each, temperatures up to 203°F (95°C), chemical dosing as desired.
- **Wash.** 0 to 30 minutes, temperatures up to 203°F (95°C), chemical dosing as desired.
- **Acid rinse.** 0 to 30 minutes, chemical dosing, temperatures up to 203°F (95°C).
- **Running water rinses.** One or more short rinse sequences after the wash or rinse cycle purge the hydraulic circuit of residual detergent and rinsing agents.
- **Rinse, DI.** Up to 4 rinses, 0 to 30 minutes each. Ambient to 203°F (95°C).
- **Final rinse, DI.** 0 to 30 minutes, temperatures up to 203°F (95°C).
- **Drying.** Up to 90 minutes, adjustable. Temperature, ambient to 230°F (110°C), Prolux Plus models; ambient to 185°F (85°C), Prolux models.
- **Cooling.** 0 to 30 minutes, adjustable.

Display screens

Featured display screens are 3.5" screen. Displays for 7" screens are identical.

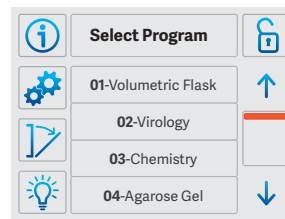

Program Selection.

The Program Selection screen lists the five factory presets, as well as additional presets added through administrator access.

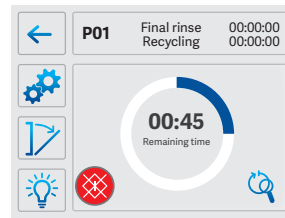

Cycle in Process.

A real-time status screen displays time remaining until cycle completion and links to cycle detail screens with the touch of a button.

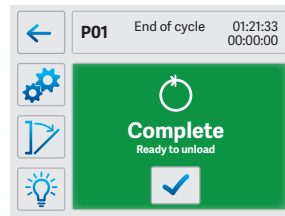

Cycle Completed.

The green Cycle Completed screen confirms completion of the cycle and indicates the washer is safe to unload.

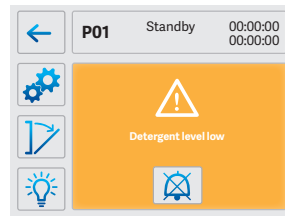

Warning Message.

The amber Warning Message screen provides a status report to prompt refill of detergent and rinse agents.

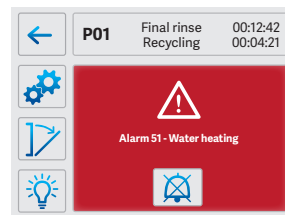

Alarm Message.

The red Alarm Message screen confirms the reason for a system shutdown and prompts corrective action needed in advance of a restart.

Configurable for your facility

Site preparation and utilities.

Pre-installation

Start-up services by factory-authorized technicians include washer set and leveling, pre-installation and final inspections, soft hook-up to utilities (in place by customer), check-out and initial operation. In addition validation documentation and execution options are available; contact us through; sales. lancer@getinge.com

Post-installation

Technical support by direct product specialists between 8AM and 7PM Eastern Time EST.

Warranty information

Getinge Lancer products are supported by a standard industry warranty.



Site preparation

910 LX / 1300 LX / 1400 LXP / 1600 LXP / 1600 LXP/HE

Water supply (hot, cold and DI)

3/4" hose thread connection, recommended min. flow 5.25 gpm (20 L);
lower flow rates may extend cycle times;
29-87 psi (200-600 kPa) water pressure

Drain requirement, vertical standpipe

1 1/2" (40 mm) diameter, 31" to 35" (800 to 900 mm) above floor.

Certifications

UL/IEC 61010-1

Bioreactor preparation solution

– consistent processes deliver repeatable results

The expertise of Getinge and Applikon research and development has established a synergistic process for bioreactor preparation.

A solution to prevent cross-contamination, minimize any research downtime and ensure validated outcome through optimal processes and procedures. Getinge offers a specially designed bioreactor wash rack for Getinge Lancer Ultima laboratory washers.

This dedicated wash rack, for the Getinge Applikon multi-use bioreactors, establishes a highly reproducible system with significant benefits such as:

- Free-up resources to increase laboratory throughput and minimize downtime
- Decreasing operational labor costs compared to manual cleaning processes
- Improving staff safety by removing potential repetitive motions and exposure of harmful substances related to manual procedures.

The relationship between the bioreactor design and laboratory washer assures predictable outcomes.

The defined connection points on the wash rack and bioreactor head plate ensures a clean bioreactor prepared for sterilization.

Empty rack

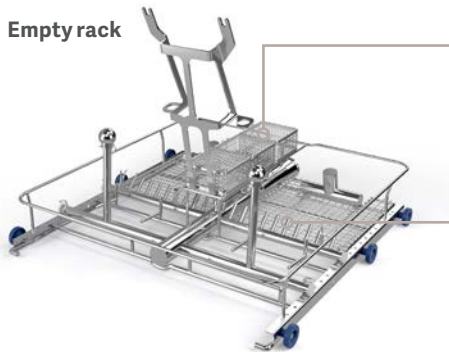

Baskets

Small bioreactor assembly parts are placed in the baskets to ensure that these are in place throughout the cleaning cycle.

Multiple injector tubes

Reassure best possible cleaning performance for each entry connection on the bioreactor head plate.

Bioreactors in place*

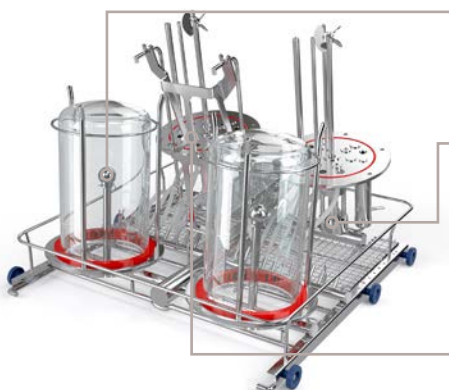

Spray headers

High flow of process water through the spray headers clean the inside of the bioreactor vessel.

Head plate fixation

The head plate is fixed in the wash rack. The spray wings within the washer will clean the outside of the head plate.

Angled head plate

Minimum water retention on the head plate surface will speed up the drying phase which shorten the overall process cycle.

*Multi-use, volume 0.26-0.79 gal (1-3 liter)



Getinge Lancer Ultima model 910 LX freestanding labware washer.

Adaptable to suit your application

Detergents and rinsing agents

For best cleaning performance there is a selection of detergents and rinse agents formulated to maximize the performance of the Getinge Lancer Ultima labware washer while minimizing water consumption. These cleaning chemicals are made specifically for use in high pressure washers. To order contact sales.lancer@getinge.com.

Getinge LancerClean detergent is available in three solutions formulated for cleaning all different types of contaminants including laboratory soils, "baked on" organic residues, petroleum applications and other hard to clean soils. Getinge LancerClean is ideal for cleaning glassware, surgical instruments and many other labware items.

- LCD-P is a potassium hydroxide based solution that provides excellent cleaning results for all types of contaminants and standard laboratory soils. It is recommended for use in all glassware washers.
- LCD-S is a sodium hydroxide based solution specifically formulated to provide exceptional cleaning for the most difficult types of contaminants.
- LCD-H is a low pH detergent comprised of a sodium silicate solution.

Getinge LCA-A, LCA-C & LCA-P rinse is available in three formulas to meet specific cleaning requirements. Used as a rinsing agent following Getinge LancerClean detergent in the wash cycle, Getinge LCA-A, LCA-C & LCA-P provides excellent results following washing of standard laboratory soils, organics, pharmaceutical based contaminants, petroleum and other difficult materials.

- LCA-A is an acetic acid based neutralizing solution. It is the most commonly used rinsing agent.
- LCA-C is an excellent rinsing agent with a citric acid based solution.
- LCA-P is a phosphoric acid solution.

Getinge Lancer Ultima undercounter labware washers

A line of compact undercounter labware washers for lower volume washing requirements. These washers are available in three models with two size options. Contact us for details.

Getinge Lancer Ultima Series



*With side chemical cabinet (SCC)

Some options available

Features		910 LX	1300 LX	1400 LXP	1600 LXP	1600 LXP/HE
Discharge water cooling	Reduces effluent temperature to less than 60°C (140°F) for code compliant transfer to utility drain.	<input type="checkbox"/>	<input type="checkbox"/>	<input type="checkbox"/>	<input type="checkbox"/>	<input type="checkbox"/>
pH programming	Neutralizes effluent before transfer to utility drain.	<input type="checkbox"/>	<input type="checkbox"/>	<input type="checkbox"/>	<input type="checkbox"/>	<input type="checkbox"/>
Printer	For hard copy permanent record.	<input type="checkbox"/>	<input type="checkbox"/>	<input type="checkbox"/>	<input type="checkbox"/>	—
Emergency stop	Emergency stop button.	<input type="checkbox"/>	<input type="checkbox"/>	<input type="checkbox"/>	<input type="checkbox"/>	<input checked="" type="checkbox"/>
Sampling valve	Manual sampling valve.	<input type="checkbox"/>	<input type="checkbox"/>	<input type="checkbox"/>	<input type="checkbox"/>	<input type="checkbox"/>
Conductivity monitoring	Conductivity meter for final rinse verification.	<input type="checkbox"/>	<input type="checkbox"/>	<input type="checkbox"/>	<input type="checkbox"/>	<input type="checkbox"/>
Pump pressure monitoring	Verification that correct pump pressure is achieved in the water distribution system that secure optimal cleaning performance.	<input type="checkbox"/>	<input type="checkbox"/>	<input type="checkbox"/>	<input type="checkbox"/>	<input type="checkbox"/>
Water softener	Water softener.	<input type="checkbox"/>	<input type="checkbox"/>	<input type="checkbox"/>	<input type="checkbox"/>	<input type="checkbox"/>
Chemical dosing pump, additional	Additional chemical dosing pump. Up to 1 additional on 910 LX / 1300 LX and up to 2 additional on 1400 LXP / 1600 LXP / 1600 LXP/HE.	<input type="checkbox"/>	<input type="checkbox"/>	<input type="checkbox"/>	<input type="checkbox"/>	<input type="checkbox"/>
Main Switch	Main power switch, shuts off all power to the washer.	—	—	<input type="checkbox"/>	<input type="checkbox"/>	<input type="checkbox"/>

Utilities		910 LX	1300 LX	1400 LXP	1600 LXP	1600 LXP/HE
Steam heating	Steam coil to utilize house steam for heating of wash/rinse water.	—	—	<input type="checkbox"/>	<input type="checkbox"/>	<input type="checkbox"/>
Low pressure kit	Boosts DI water supply input pressure to assure optimum performance.	<input type="checkbox"/>	<input type="checkbox"/>	<input type="checkbox"/>	<input type="checkbox"/>	<input type="checkbox"/>
Steam condenser	Steam condenser for collapsing exhaust vapor.	<input type="checkbox"/>	<input type="checkbox"/>	<input type="checkbox"/>	<input type="checkbox"/>	<input type="checkbox"/>
Gravity drain	For quick evacuation of chamber. Requires compressed air and floor drain.	—	—	<input type="checkbox"/>	<input type="checkbox"/>	<input type="checkbox"/>
Tri-clamp DI inlet	Direct DI water inlet with tri-clamp connection and dry contact for control of customer DI loop valve.	—	—	<input type="checkbox"/>	<input type="checkbox"/>	<input type="checkbox"/>

Construction		910 LX	1300 LX	1400 LXP	1600 LXP	1600 LXP/HE
Moving runners	Customized location of rack manifolds to accommodate specific loads.	—	—	<input type="checkbox"/>	<input type="checkbox"/>	<input type="checkbox"/>
Extended diptube kit	Extended diptubes for use with 33-55 gal (125-208 L) chemical containers.	—	—	<input type="checkbox"/>	<input type="checkbox"/>	<input type="checkbox"/>
Dry contact	Dry contacts for external communication.	<input type="checkbox"/>	<input type="checkbox"/>	<input type="checkbox"/>	<input type="checkbox"/>	<input type="checkbox"/>
Seismic restraints	Seismic tie down brackets.	<input type="checkbox"/>	<input type="checkbox"/>	<input type="checkbox"/>	<input type="checkbox"/>	<input type="checkbox"/>
Stainless steel plumbing	Complete stainless steel hydraulic circuit including main circulation pump	—	—	<input type="checkbox"/>	<input type="checkbox"/>	<input type="checkbox"/>
View-In-Process window	 Includes interior light, permitting visual verification during wash cycles.	<input type="checkbox"/>	<input type="checkbox"/>	<input type="checkbox"/>	<input type="checkbox"/>	—

* See product specifications for details and additional options to select.

/ Standard / optional features

Common accessories

Choose from up to 60 different injector racks, pipette racks and baskets. All racks are interchangeable between the washer lower and upper levels.

- A wide variety of standard inventory baskets and injector racks are available to meet most needs.
- Custom racks and baskets can be fabricated to meet specific needs or special applications.

Please note. All dimensions in the accessories section are in millimeters, unless otherwise stated.

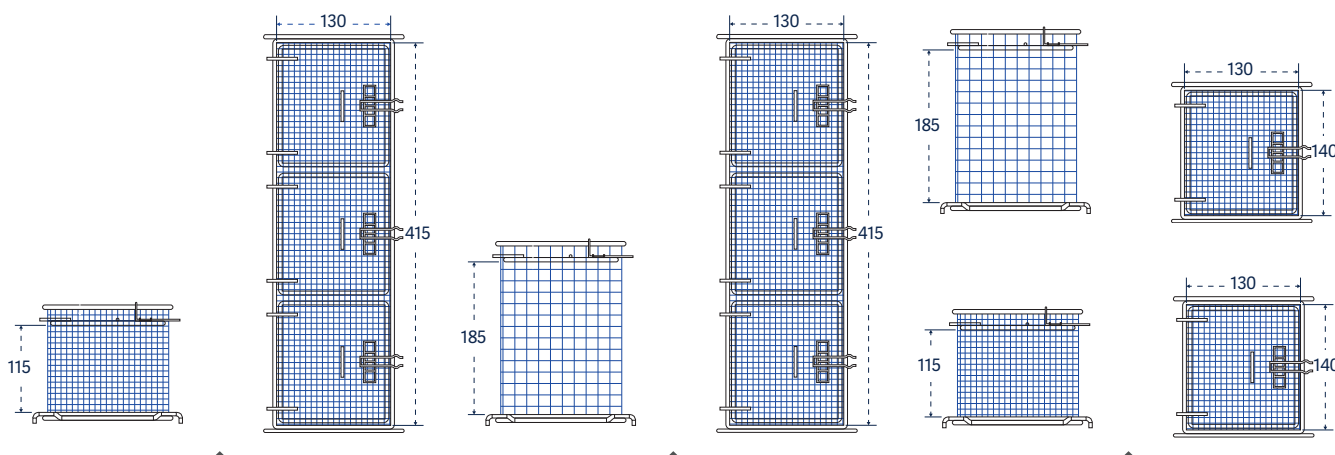

Small mesh basket with cover, long:
Catalog No. STCXL



Small mesh basket, tall with cover, long:
Catalog No. LTCXL



Small mesh baskets, tall and short:
Catalog No. LTC and STC

Small mesh baskets

For bottle caps, ferrules, plugs, stoppers and test tubes.

910 LX / 1300 LX / 1400 LXP / 1600 LXP / 1600 LXP/HE

Part number

Mesh basket, short, with cover, 130x118x98 mm

STC

02010037

Mesh basket, short, with cover, 405x118x98 mm

STCXL

02010038

Mesh basket, tall, with cover, 130x118x170 mm

LTC

02010029

Mesh basket, tall, with cover, 405x118x170 mm

LTCXL

02010030





Accessories

910 LX / 1300 LX



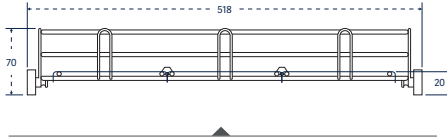

Basic basket with reversible tray lid:
Catalog No. PST and GC



Basic basket with spray arm:
Catalog No. PSBT



Basket for culture dishes: Catalog No. BP

Baskets

Useful for beakers, trays, dishes, dissolution vessels, funnels, instruments and jars.

	910 LX / 1300 LX	Part number
Basic basket	PST	02600011
Basic basket with spray arm	PSBT	02600010
Support for culture plates (20 pcs./support max 3 supports) to be used with the PST basket	20 PL	01030417

Basket covers

Accessory basket covers are available to secure small or lightweight labware during the wash cycle.

	910 LX / 1300 LX	Part number
Reversible tray lid for PST/PSBT	GC	01030569
Reversible tray lid, half size for PST/PSBT	GC1/2	01030570
Reversible tray lid for injector rack	GC	01030585
Reversible tray lid, half size for injector rack	GC1/2	01030586



Short injectors

For inside out cleaning of narrow neck glassware, bottles, cylinders, boiling flasks, Erlenmeyer flasks and volumetric flasks.

910 LX / 1300 LX

Part number

Half rack, 27 short jets, 6 mm diameter

27 IXC 1/2

02600022

36 short jets, 6 mm diameter

36 IXC

02600023

41 short jets, 6 mm BOD rack

41 IXC

02600003

48 short jets, 2 mm diameter

48 IXA

02600026

48 short jets, 6 mm diameter

48 IXC

02600027

64 short jets, 2 mm diameter

64 IXA

02600030

64 short jets, 6 mm diameter

64 IXC

02600032

64 short jets, mixed 2 mm and 6 mm diameter

64 IXA/2

02600031

100 short jets, 2 mm diameter

100 IXA

02600016

100 short jets, 6 mm diameter

100 IXC

02600018

100 short jets, mixed 2 mm and 6 mm diameter

100 IXA/2

02600017



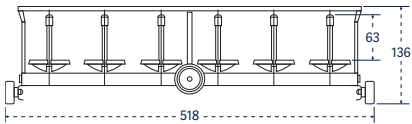
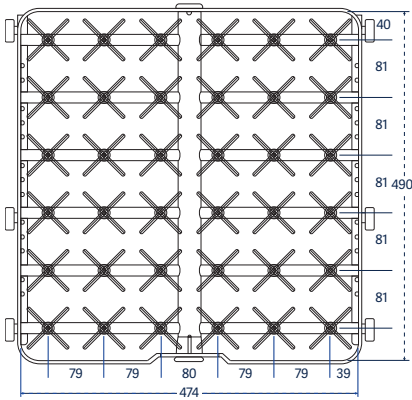

Catalog No. 36 IXC

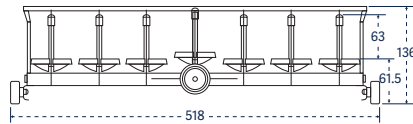
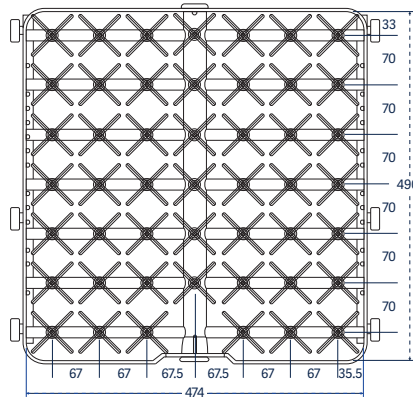

Catalog No. 48 IXC; IXA

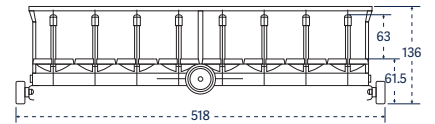
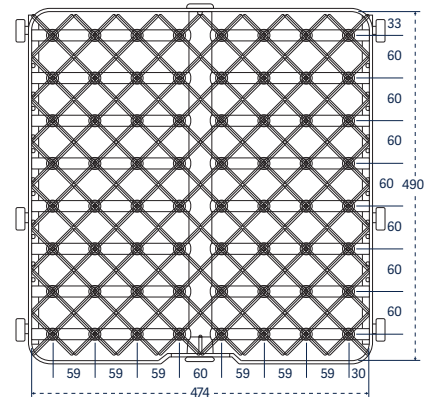

Catalog No. 64 IXA; IXC; IXA/2

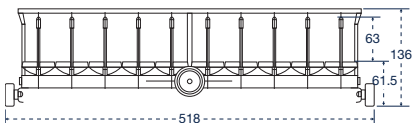
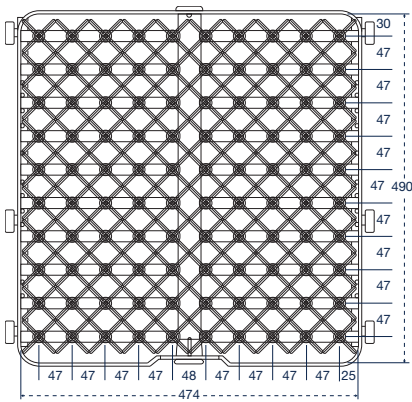

Catalog No. 100 IXA; IXC; IXA/2

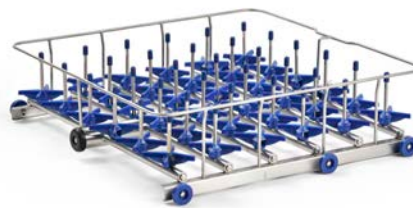

IXC: Injector rack, short injectors, 3" (76 mm) tall, jets 6 mm diameter



IXA: Injector rack, short injectors, 3" (76 mm) tall, jets 2 mm diameter

Long injectors

For inside out cleaning of large narrow neck glassware, bottles, cylinders, boiling flasks, Erlenmeyer flasks and volumetric flasks.

910 LX / 1300 LX

Part number

5 long jets, 12.7 mm diameter, with spray ball

5 IXL

02600007

9 long jets, 12.7 mm diameter, with spray ball

9 IXL

AA02250223

12 long jets, 8 mm diameter

12 IXL

AA02250224

20 long jets, 8 mm diameter

20 IXL

02600021

36 long jets, 6 mm diameter

36 IXL

02600024

48 long jets, 6 mm diameter

48 IXL

02600028

64 long jets, 6 mm diameter

64 IXL

02600033

100 long jets, 6 mm diameter

100 IXL

02600019

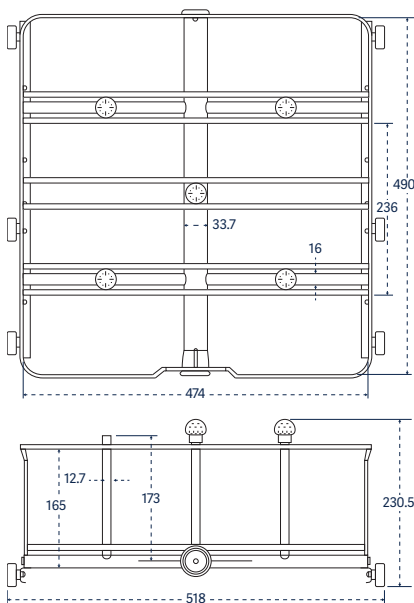

Catalog No. 5 IXL



Catalog No. 9 IXL



Adjustable clip positions labware on injector for optimal cleaning performance.

Extra long injectors

For inside out cleaning of narrow neck glassware, bottles, cylinders, boiling flasks, Erlenmeyer flasks and large volumetric flasks.

910 LX / 1300 LX

Part number

1 long jet, 12.7 mm diameter, with spray ball

1 IXL

02600001

2 long jets, 12.7 mm diameter, with spray ball

2 IXL

02600014

4 long jets, 12.7 mm diameter, with spray ball

4 IXL

02600005

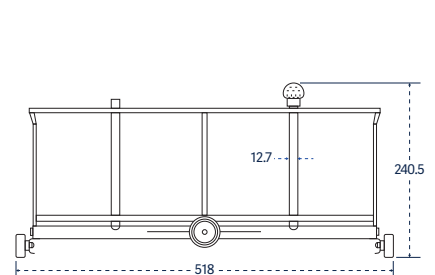
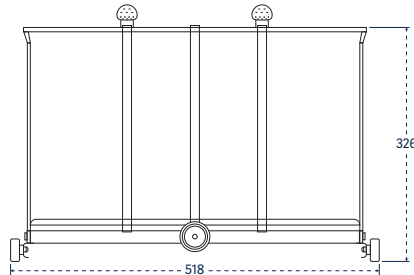
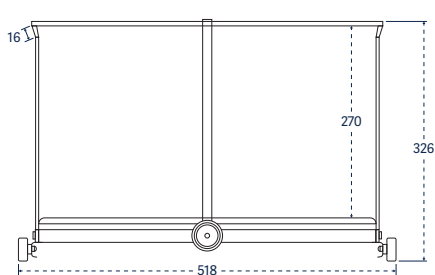
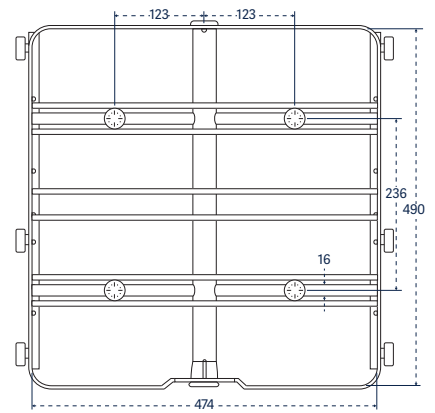
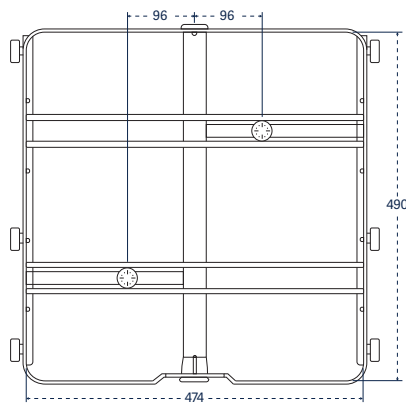
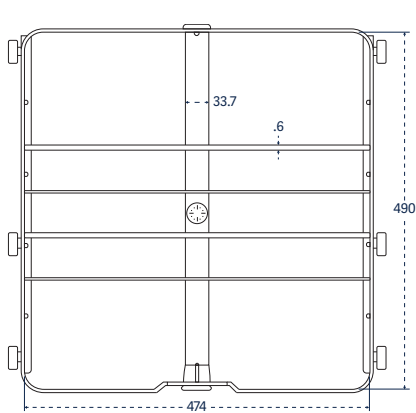

Catalog No. 1 IXL

Catalog No. 2 IXL

Catalog No. 4 IXL

Combination short/long injectors

For inside out cleaning of mixed loads of narrow neck glassware, bottles, cylinders, boiling flasks, Erlenmeyer flasks and volumetric flasks.

	910 LX / 1300 LX	Part number
36 short and long jets, 6 mm diameter	36 IXLC	02600025
48 short and long jets, 6 mm diameter	48 IXLC	02600029
48 short and long jets, 6 mm diameter, 2 rows 2 mm diameter	48 IXLCA	02600006
64 short and long jets, 6 mm diameter	64 IXLC	02600034
100 short and long jets, 6 mm diameter	100 IXLC	02600020

Injector KIT packages

KIT enable customization of standard injector racks to fit specific needs. Each KIT include 10 complete injectors with their supports and nozzles.

	Part number
Long injectors, length of 230 mm and 6 mm diameter	6007500984
Long injectors, length of 171 mm and 6 mm in diameter	6007500890
Short injectors, length of 86 mm and 6 mm in diameter	6007500957
Short injectors, length of 56 mm and 6 mm in diameter	6007501012
Long injectors, length of 171 mm and 8 mm in diameter	6007501011
Needle injectors, length of 86 mm	6007501007

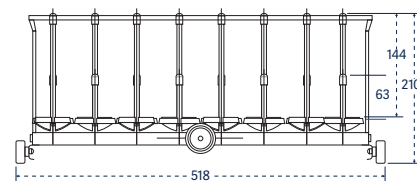
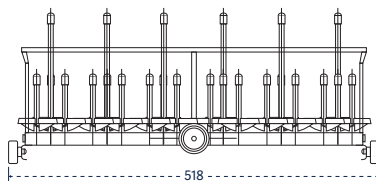
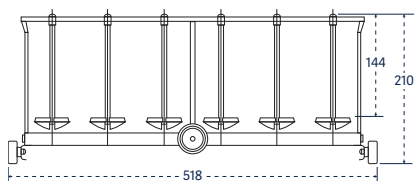
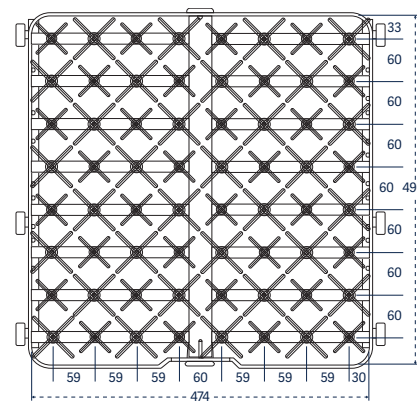
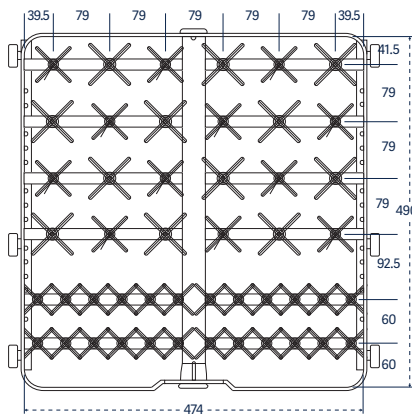
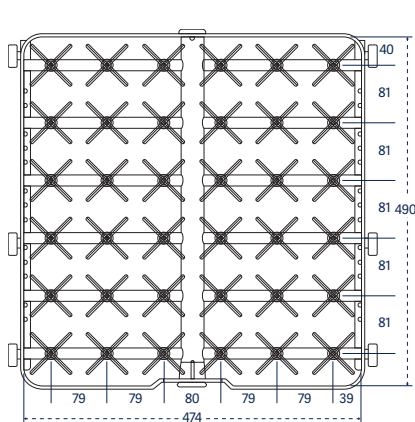
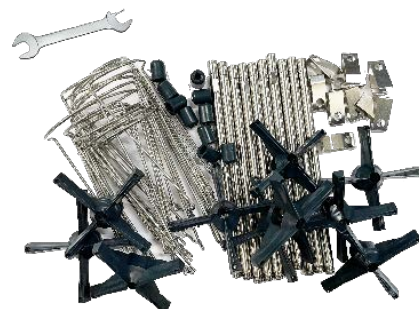

Catalog No. 36 IXLC

Catalog No. 48 IXLC; IXCLA

Catalog No. 64 IXLC

Multipurpose racks For a combination of labware and pipettes.	910 LX / 1300 LX	Part number
Basic basket plus 27 short and long jets	PS/27 IXLC	02600039
25 pipettes, angled plus 24 short and long jets	25 PIP/24 IXLC	02600004
50 pipettes, angled plus 34 short and long jets	50 PIP/34 IXLC	02600037
14 short jets plus 4 long injectors angled and perforated	4 EP/14 IXC	02600041
28 short and long jets plus 4 long injectors, angled and perforated	4 EP/28 IXLC	02600036
One third PS plus 21 short and long jets, plus 25 pipettes	PS/21 IXLC/25 PIP	02600038

Bioreactor rack	910 LX / 1300 LX	Part number
Rack for 0.26-0.79 gal (1-3 L) Bioreactors	BRWR	AA02600113

Pipette racks Accessory pipette racks are configured to accommodate reusable pipettes.	910 LX / 1300 LX	Part number
Grommet style, individually loaded, 100 position	100 PIP	02600040

Grommet style, individually loaded, 100 position

100 PIP

02600040



Catalog No. BRWR

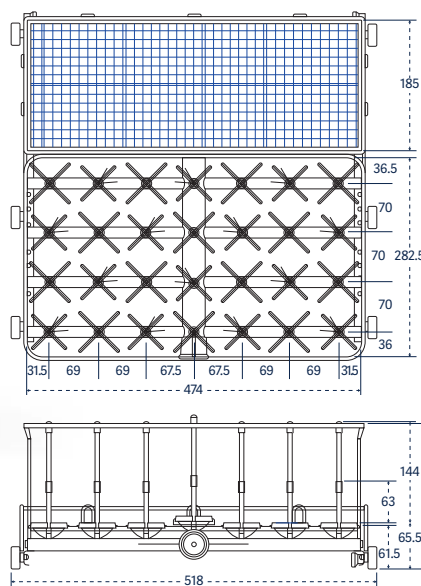

Catalog No. PS/27/IXLC

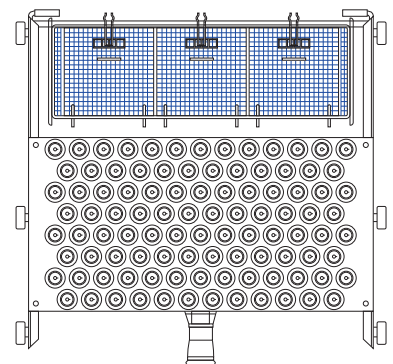

Catalog No. 100 PIP

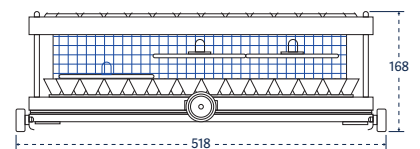

Storage stand

An accessory storage stand offers a convenient place to store accessory racks and baskets when not in use.

910 LX / 1300 LX

Part number

Holds up to 5 racks

RP

01040060

Trolley

The stainless steel loading trolley transfers the load and mates with the washer to simplify loading and unloading. The trolley includes a retainer lip to keep the floor dry from residual water. Includes locking casters.

910 LX

1300 LX

Loading trolley

TN 910 LX

TN 13





Accessories

1400 LXP



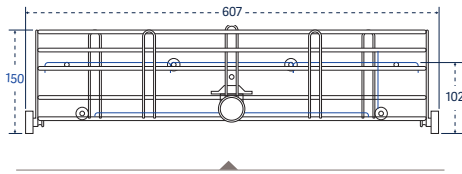

Basic basket with reversible tray lid:
Catalog No. PST and GC



Basic basket with spray arm: Catalog No.
PSBT



Basket for culture dishes: Catalog No. BP

Baskets		
Useful for beakers, trays, dishes, dissolution vessels, funnels, instruments and jars.	1400 LXP	Part number
Basic basket	PST 14	02600051
Basic basket with spray arm	PSBT 14	02600050
Basket, half with spray arm	PSBT 1/2 14	02600048
Support for culture plates (20 pcs./support max 3 supports) to be used with the PST basket	20 PL	01030417

Basket covers for basic grid baskets		
Accessory basket covers are available to secure small or lightweight labware during the wash cycle.	1400 LXP	Part number
Reversible tray lid for PST/PSBT	GC 14	02250017
Reversible tray lid, half size for PST/PSBT	GC 1/2 14	02250024

Short injectors For inside out cleaning of narrow neck glassware, bottles, cylinders, boiling flasks, Erlenmeyer flasks and volumetric flasks.	1400 LXP	Part number
48 short jets, 6 mm diameter	48 IXC 14	02600059
64 short jets, 6 mm diameter	64 IXC 14	02600063
64 short jets, mixed 2 mm and 6 mm diameter	64 IXA/2 14	02600062
81 short jets, 6 mm diameter	81 IXC 14	02600068
81 short jets, 6 mm diameter	81 IXC 14	02600068
81 short jets, mixed 2 mm and 6 mm diameter	81 IXA/2 14	02600066
100 short jets, 2 mm diameter	100 IXA 14	02600054
100 short jets, 6 mm diameter	100 IXC 14	02600053
100 short jets, mixed 2 mm and 6 mm diameter	100 IXA/2 14	02600052



Long injectors For inside out cleaning of large narrow neck glassware, bottles, cylinders, boiling flasks, Erlenmeyer flasks and volumetric flasks.	1400 LXP	Part number
12 long jets, 8 mm diameter	12 IXL 14	02600044
24 long jets, 8 mm diameter	24 IXL 14	AA0260016
36 long jets, 6 mm diameter	36 IXL 14	02600057
48 long jets, 6 mm diameter	48 IXL 14	02600060
64 long jets, 6 mm diameter	64 IXL 14	02600064



Injector rack covers

Injector rack covers are available to secure small or lightweight labware during the wash cycle.

1400 LXP

Part number

Injector rack cover full-size

GCI 14

02250023

Injector rack cover half-size

GCI 1/2 14

02250024

Reversible tray lid for injector rack

GCI 14

02250023

Reversible tray lid, half size for injector rack

GCI 1/2 PS

02250025

Cover for 1/2 injector basket

GCI 1/2 14

02250024

Adjustable cross grid

GA 14

02250051

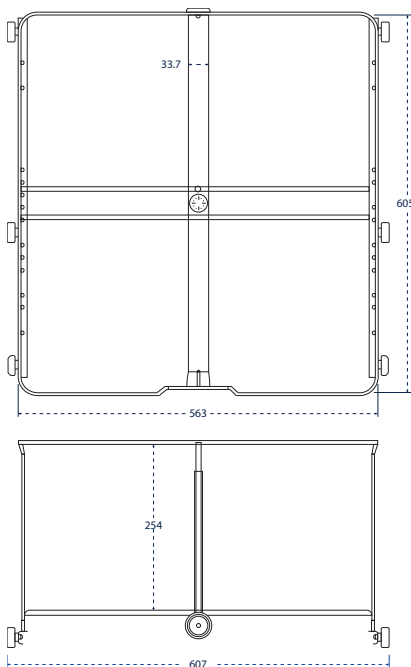

Catalog No. 1 IXL 14

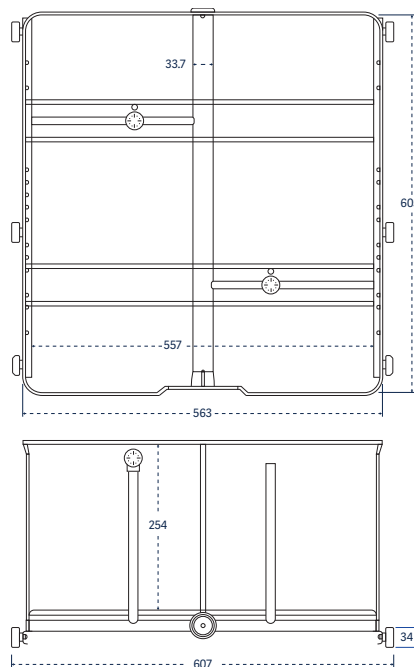

Catalog No. 2 IXL 14

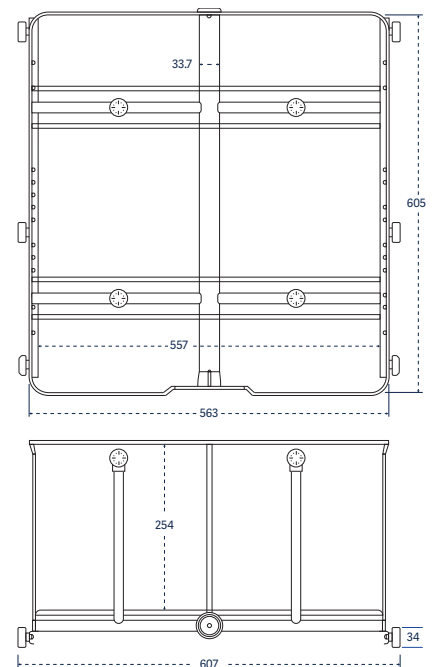

Catalog No. 4 IXL 14

Extra long injectors, 305 mm (12") tall

For inside out cleaning of narrow neck glassware, bottles, cylinders, boiling flasks, Erlenmeyer flasks and large volumetric flasks.

1400 LXP

Part number

1 long jet, 12.7 mm diameter, with spray ball

1 IXL 14

02600043

2 long jets, 12.7 mm diameter, with spray ball

2 IXL 14

02600045

4 long jets, 12.7 mm diameter, with spray ball

4 IXL 14

02600046

Combination short/long injectors

For inside out cleaning of mixed loads of narrow neck glassware, bottles, cylinders, boiling flasks, Erlenmeyer flasks and volumetric flasks.

1400 LXP

Part number

36 short and long jets, 6 mm diameter

36 IXLC 14

02600058

48 short and long jets, 6 mm diameter

48 IXLC 14

02600061

64 short and long jets, 6 mm diameter

64 IXLC 14

02600065

81 short and long jets, 6 mm diameter

81 IXLC 14

02600069

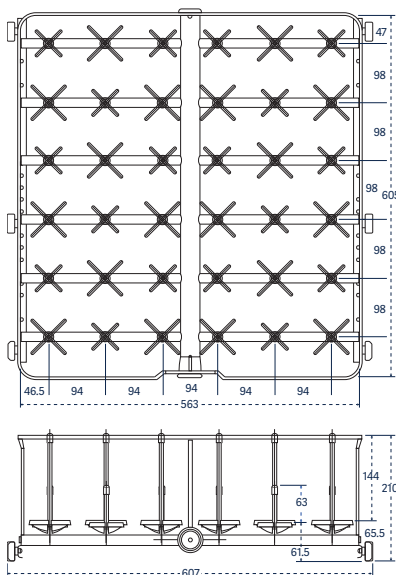

Catalog No. 36 IXLC 14

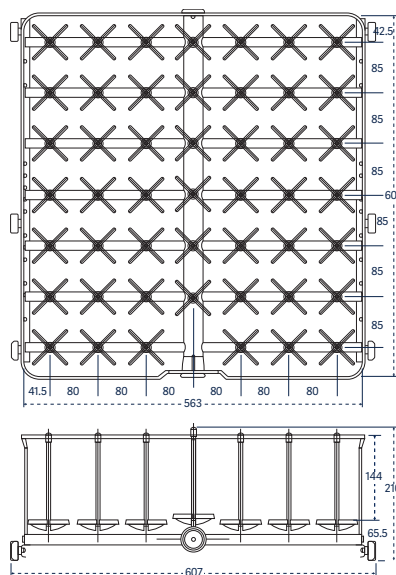

Catalog No. 48 IXLC 14

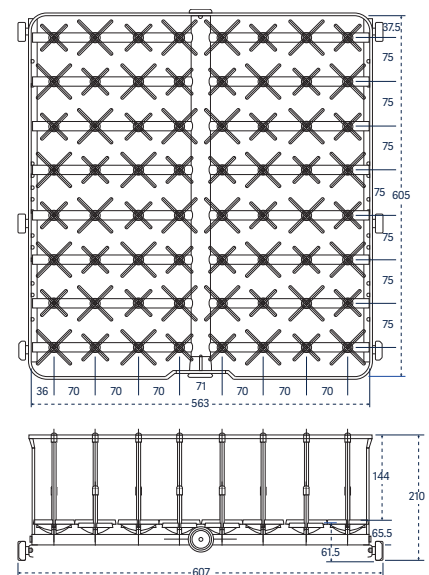

Catalog No. 64 IXLC 14

Multipurpose racks		
For a combination of labware and pipettes.	1400 LXP	Part number
Basic basket plus 32 short and long jets	PS/32 IXLC 14	02600071
31 pipettes, angled plus 25 short and long jets	31 PIP/25 IXLC 14	02600072
24 short and long jets plus 4 long injectors, angled and perforated	4 EP/24 IXLC 14	02600074
Bioreactor rack		
	1400 LX / 1400 LXP	Part number
Rack for 0.26-0.79 gal (1-3 L) Bioreactors	BRWR 14	AA02600114
Pipette racks		
Accessory pipette racks are configured to accommodate reusable pipettes.	1400 LXP	Part number
Grommet style, individually loaded, 124 position	124 PIP 14	02600012
Pipette rack, canisters (4)	PPI 4B 14	02600075

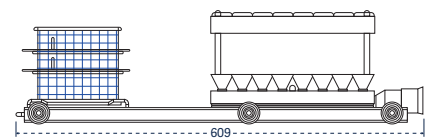
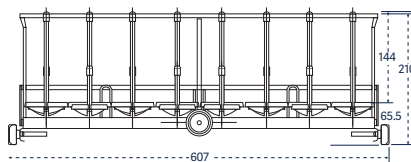
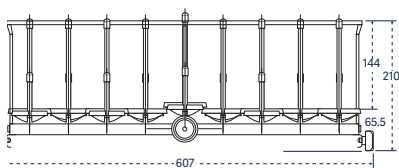
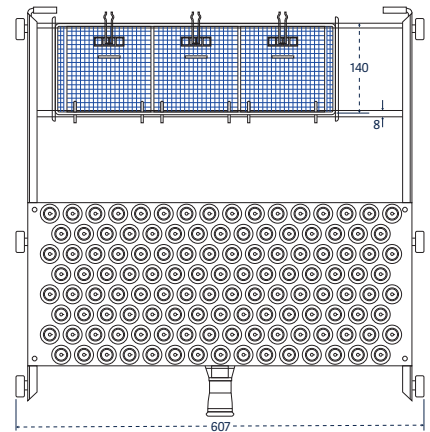
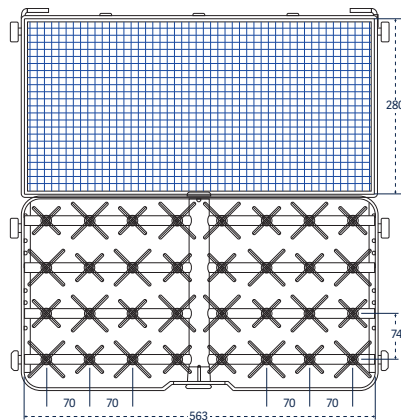
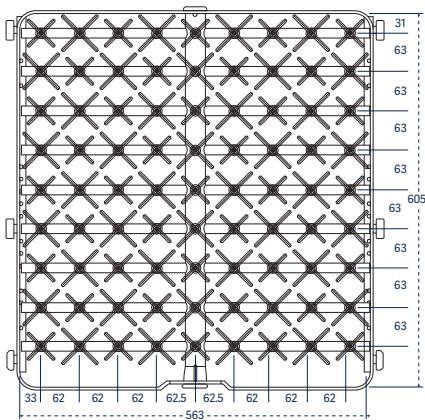

Catalog No. 81 IXLC 14

Catalog No. PS/32 IXLC 14

Catalog No. 124 PIP 14

Injector KIT packages

KIT enable customization of standard injector racks to fit specific needs. **Part number**
Each KIT include 10 complete injectors with their supports and nozzles.

Long injectors, length of 230 mm and 6 mm diameter	6007500984
Long injectors, length of 171 mm and 6 mm in diameter	6007500890
Short injectors, length of 86 mm and 6 mm in diameter	6007500957
Short injectors, length of 56 mm and 6 mm in diameter	6007501012
Long injectors, length of 171 mm and 8 mm in diameter	6007501011
Needle injectors, length of 86 mm	6007501007



Storage stand

An accessory storage stand offers a convenient place to store accessory racks and baskets when not in use.

1400 LXP

Part number

Holds up to 5 racks

RP 14

02250026

Trolley

The stainless steel loading trolley transfers the load and mates with the washer to simplify loading and unloading. The trolley includes a retainer lip to keep the floor dry from residual water. Includes locking casters.

1400 LXP

Part number

Trolley, 3 levels

TN 14

02530019

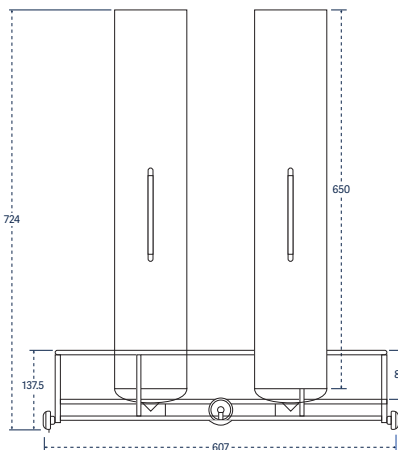
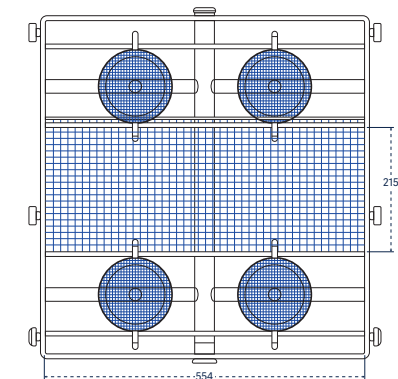

Catalog No. PPI 4B 14



Accessories

1600 LXP / 1600 LXP/HE



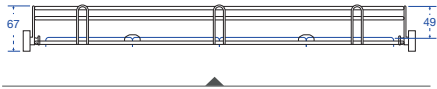

Basic basket with reversible tray lid:
Catalog No. PST and GC



Basic basket with spray arm: Catalog No.
PSBT



Basket for culture dishes: Catalog No. BP

Baskets

Useful for beakers, trays, dishes, dissolution vessels, funnels, instruments and jars.

1600 LXP

Part number

Basic basket

PST 16

02600084

Basic basket with spray arm

PSBT 16

02600083

**Support for culture plates (20 pcs./support max 3 supports)
to be used with the PST basket**

20 PL

01030417

Basket covers

Accessory basket covers are available to secure small or lightweight labware during the wash cycle.

1600 LXP

Part number

Reversible tray lid for PST/PSBT

GC 16

01030573

Reversible tray lid for injector racks

GCI 16

01030589

Short injectors For inside out cleaning of narrow neck glassware, bottles, cylinders, boiling flasks, Erlenmeyer flasks and volumetric flasks.	1600 LXP	Part number
36 short jets, 6 mm diameter	36 IXC 16	02600096
64 short jets, 6 mm diameter	64 IXC 16	02600100
80 short jets, 6 mm diameter	80 IXC 16	02600073
100 short jets, 2 mm diameter	100 IXA 16	02600088
100 short jets, 6 mm diameter	100 IXC 16	02600090
100 short jets, mixed 2 mm and 6 mm diameter	100 IXA/2 16	02600089
144 short jets, 2 mm diameter	144 IXA 16	02600093
144 short jets, 6 mm diameter	144 IXC 16	02600095
144 short jets, mixed 2 mm and 6 mm diameter	144 IXA/2 16	02600094



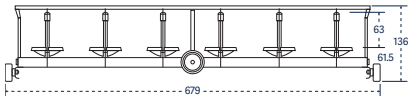
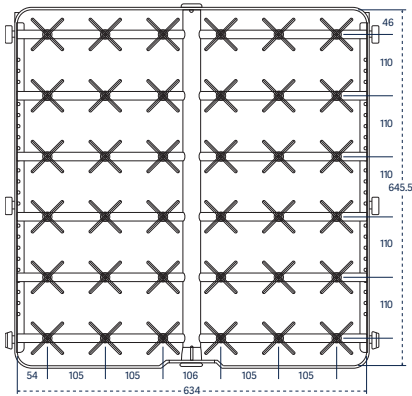

Catalog No. 36 IXC 16

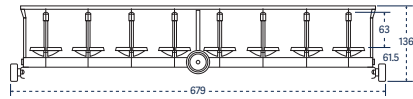
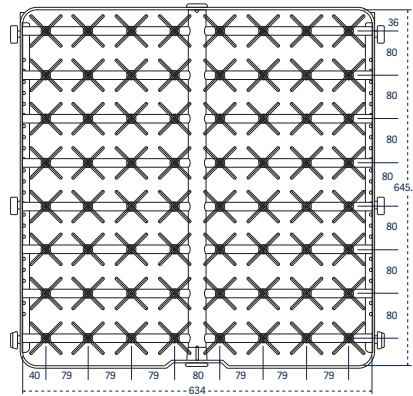

Catalog No. 64 IXC 16

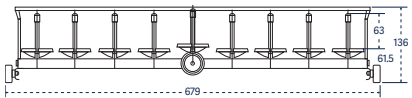
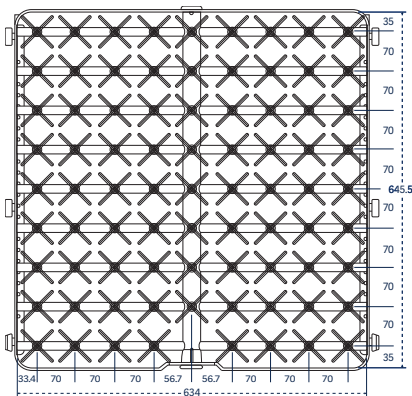

Catalog No. 80 IXC 16

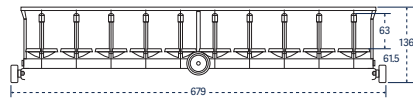
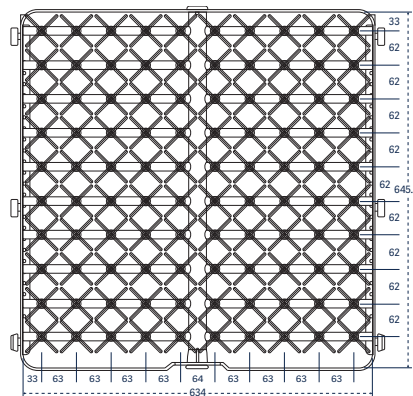

Catalog No. 100 IXA; IXC; IXA/2 16

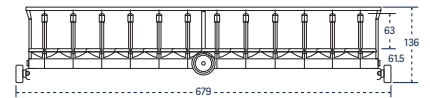
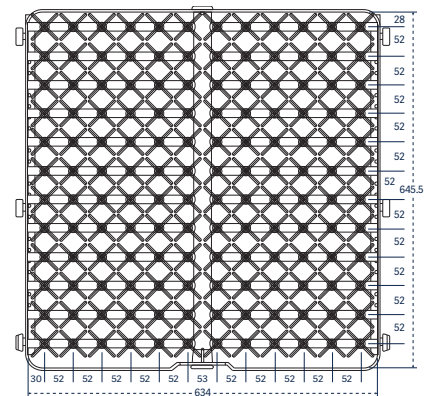

Catalog No. 144 IXA; IXC; IXA/2 16

Long injectors

For inside out cleaning of large narrow neck glassware, bottles, cylinders, boiling flasks, Erlenmeyer flasks and volumetric flasks.

1600 LXP

Part number

5 long jets, 12.7 mm diameter, with spray ball

5 IXL 16

02600080

9 long jets, 12.7 mm diameter, with spray ball

9 IXL 16

02600081

12 long jets, 6 mm diameter

12 IXL 16

02600077

36 long jets, 6 mm diameter

36 IXL 16 D6

02600098

36 long jets, 8 mm diameter

36 IXLC 16

02600097

64 long jets, 6 mm diameter

64 IXL 16

02600101

80 long jets, 6 mm diameter

80 IXL 16

02600104

100 long jets, 6 mm diameter

100 IXL 16

02600091

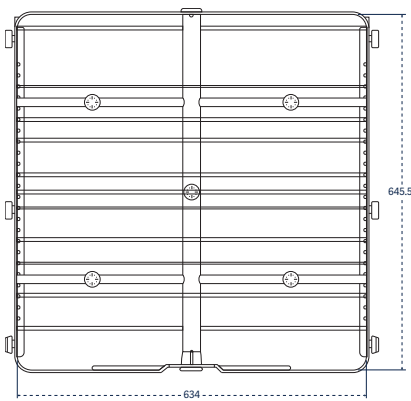

Catalog No. 5 IXL 16

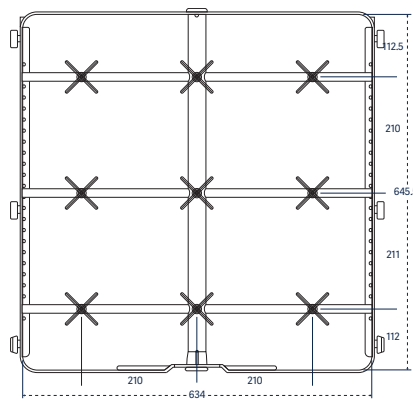

Catalog No. 9 IXL 16

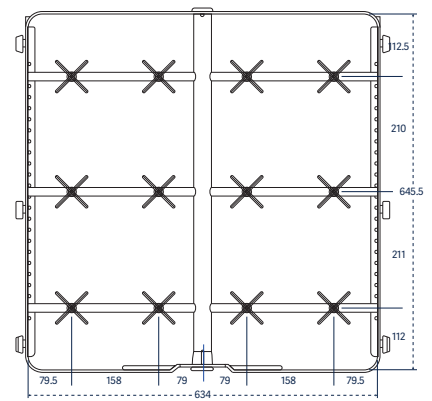

Catalog No. 12 IXL 16

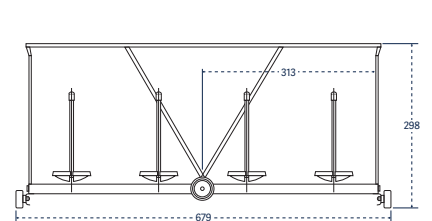
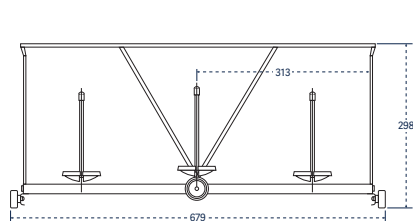
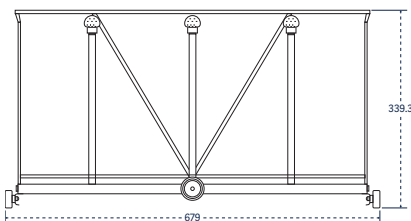

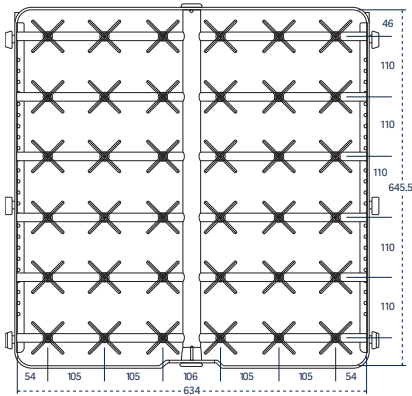

Catalog No. 36 IXL 16 D6

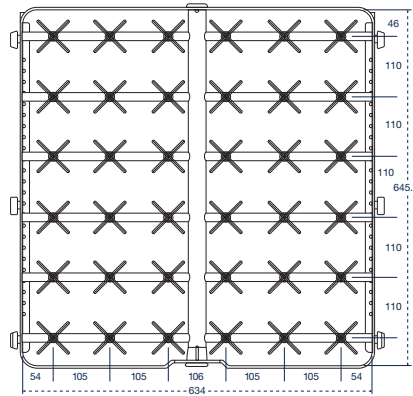

Catalog No. 36 IXL 16

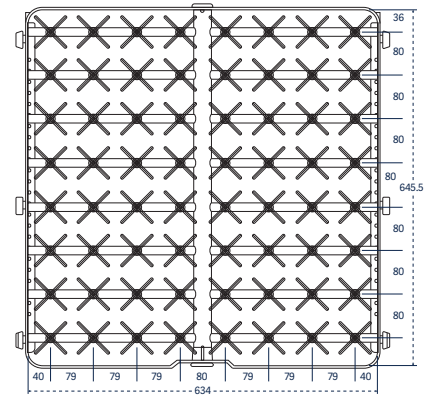

Catalog No. 64 IXL 16

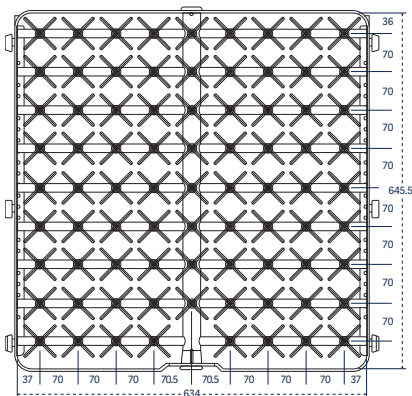

Catalog No. 80 IXL 16

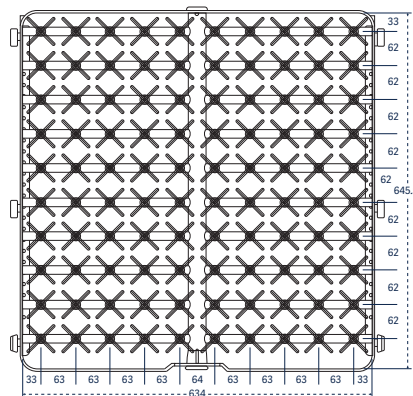

Catalog No. 100 IXL 16

Extra long injectors, 12" (305 mm) tall

For inside out cleaning of narrow neck glassware, bottles, cylinders, boiling flasks, Erlenmeyer flasks and large volumetric flasks.

1600 LXP

Part number

1 long jet, 12.7 mm diameter, with spray ball

1 IXL 16

02600076

2 long jets, 12.7 mm diameter, with spray ball

2 IXL 16

02600078

4 long jets, 12.7 mm diameter, with spray ball

4 IXL 16

02600079

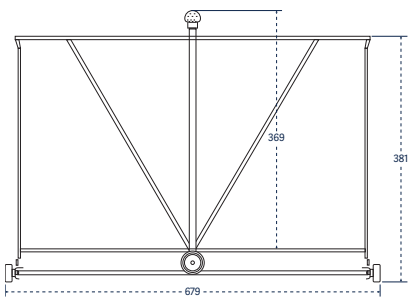
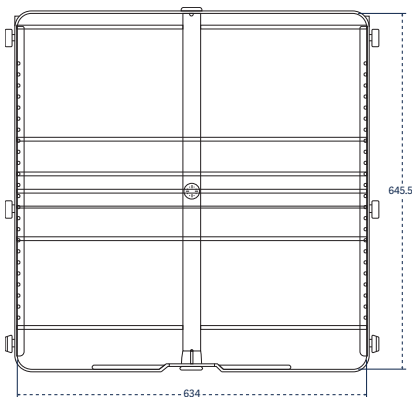

Catalog No. 1 IXL 16

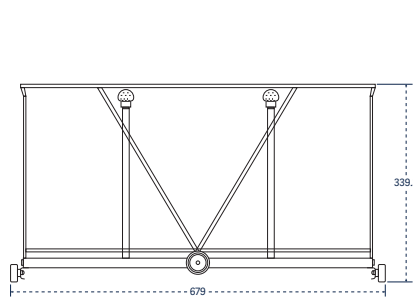
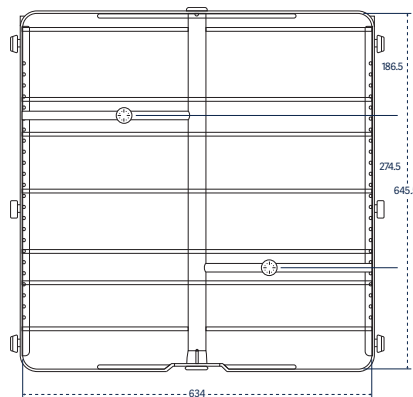

Catalog No. 2 IXL 16

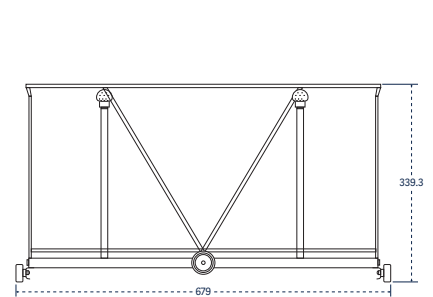
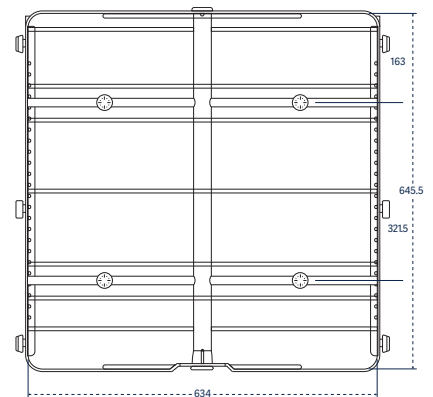

Catalog No. 4 IXL 16

Combination short/long injectors

For inside out cleaning of mixed loads of narrow neck glassware, bottles, cylinders, boiling flasks, Erlenmeyer flasks and volumetric flasks.

1600 LXP

Part number

36 short and long jets, 6 mm diameter

36 IXLC 16

02600099

64 short and long jets, 6 mm diameter

64 IXLC 16

02600102

80 short and long jets, 6 mm diameter

80 IXLC 16

02600105

100 short and long jets, 6 mm diameter

100 IXLC 16

02600092

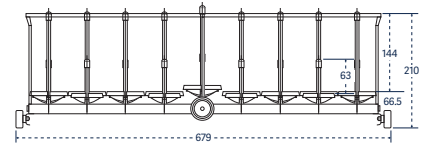
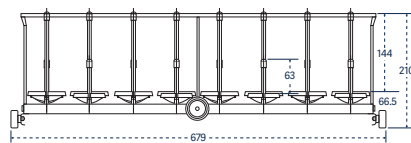
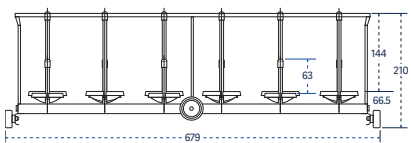
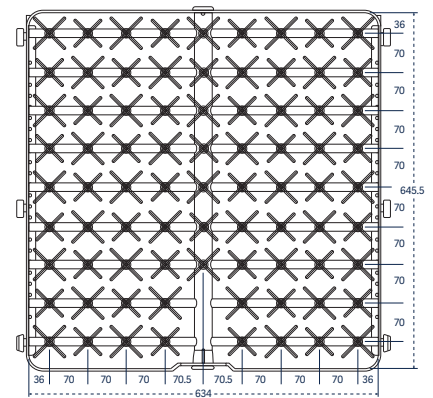
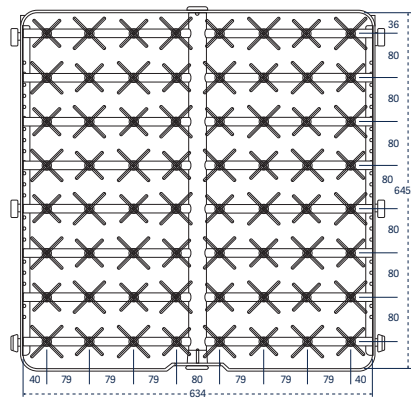
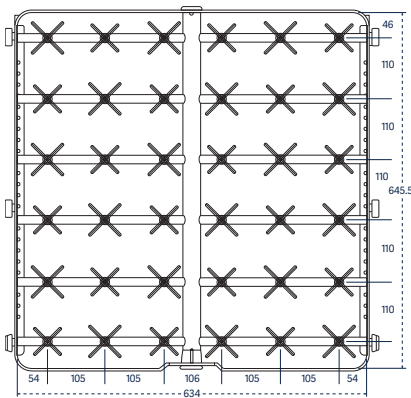

Catalog No. 36 IXLC 16

Catalog No. 64 IXLC 16

Catalog No. 80 IXLC 16

Injector KIT packages

KIT enable customization of standard injector racks to fit specific needs. Each KIT include 10 complete injectors with their supports and nozzles.

	Part number
Long injectors, length of 230 mm and 6 mm diameter	6007500984
Long injectors, length of 171 mm and 6 mm in diameter	6007500890
Short injectors, length of 86 mm and 6 mm in diameter	6007500957
Short injectors, length of 56 mm and 6 mm in diameter	6007501012
Long injectors, length of 171 mm and 8 mm in diameter	6007501011
Needle injectors, length of 86 mm	6007501007



Trolley

The stainless steel loading trolley transfers the load and mates with the washer to simplify loading and unloading. The trolley includes a retainer lip to keep the floor dry from residual water. Includes locking casters.

1600 LXP

Part number

Trolley, 4 levels

TN 16

02530020

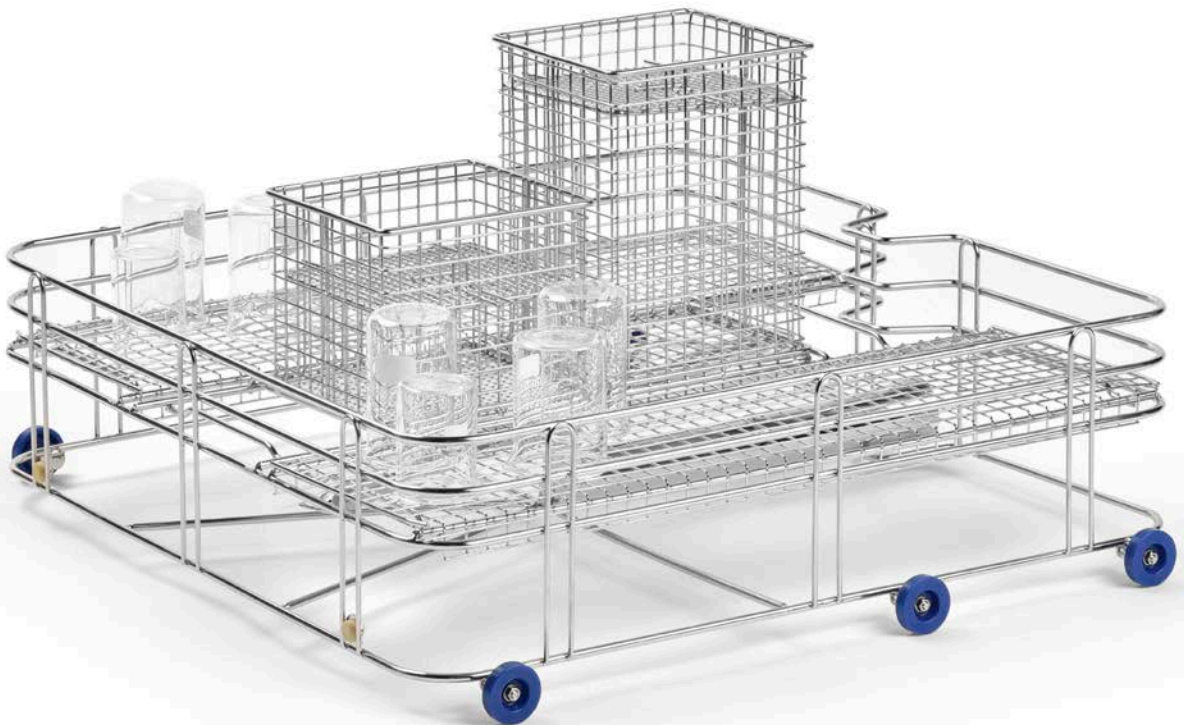



Getinge is a global provider of innovative solutions for Life Science companies and institutions, operating rooms, intensive care units and sterilization departments. Based on our firsthand experience and close partnerships with Life Science companies, clinical experts, healthcare professionals and medtech specialists, we are improving everyday life for people – today and tomorrow.

This document is intended to provide information to a North American audience.

Getinge USA Sales · LLC 1150 Emma Oaks Trail Suite 140 · Lake Mary FL 32746 · USA
Phone: 1-800-332-1855 · E-mail: Sales.lancer@getinge.com

www.getinge.com/US