

# STABILITY CHAMBERS WITH HUMIDITY CONTROL

## OWNERS MANUAL

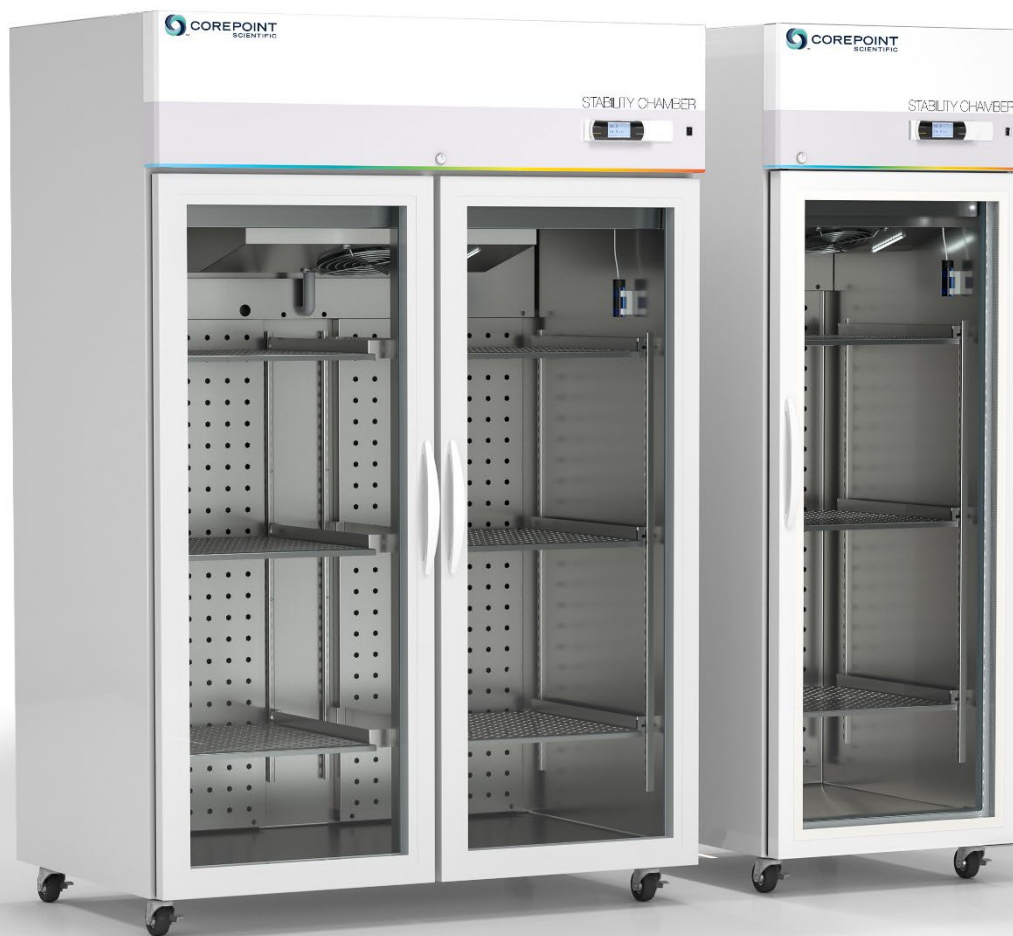

---

# STABILITY CHAMBERS WITH HUMIDITY CONTROL Installation, Operation and Maintenance Instructions

---

## TABLE OF CONTENTS

<b>GENERAL</b> .....	<b>4</b>
INTENDED USE .....	4
TECHNICAL SPECIFICATION .....	4
RECEIVING AND SHIPPING DAMAGE HANDLING .....	3
UNPACKING .....	4
WARNINGS AND CAUTIONS .....	5
LOCATION .....	6
INSTALLATION .....	6
HUMIDIFIER INSTALLATION.....	9
DRAIN INSTALLATION .....	9
ELECTRICAL INSTALLATION.....	9
OPERATION.....	11
<b>PROGRAMMABLE CONTROLLER</b> .....	<b>12</b>
CONTROLLER OVERVIEW .....	13
STARTING UP AND OPERATING THE CONTROLLER .....	14
SET POINTS .....	16
RAMP AND SOAK SCHEDULE.....	20
PARAMETERS .....	23
QUALITY CONTROL .....	30
ALARM TEST .....	31
ALARMS .....	32
USB PORT .....	33
<b>MAINTENANCE</b> .....	<b>35</b>
PERIODIC CLEANING .....	35
HUMIDIFIER MAINTENANCE .....	35
MAINTENANCE SERVICE AND ANALYSIS GUIDE .....	37
<b>PIPING DIAGRAM</b> .....	<b>38</b>
<b>FACTORY WARRANTY</b> .....	<b>39</b>

# GENERAL

## INTENDED USE

The stability chamber is designed to meet the demanding requirements for scientific and laboratory research. Advanced engineered design incorporates the latest in cabinet, refrigeration, temperature control and monitoring features. The unit provides energy efficient, convenient, safe and reliable performance for optimal temperature environments necessary for a wide range of life science, pharmacy, biological, medical, clinical and industrial applications.

## TECHNICAL SPECIFICATION

Voltage supply: 115Vac 60Hz 1 phase  
Maximum fuse size: 15A  
Total amp draw: 12.0A  
Temperature Range: 4°C to 70°C  
Humidity Range\*: 10% to 95% R.H

\*Note: Humidity range is temperature dependent. See performance envelope.

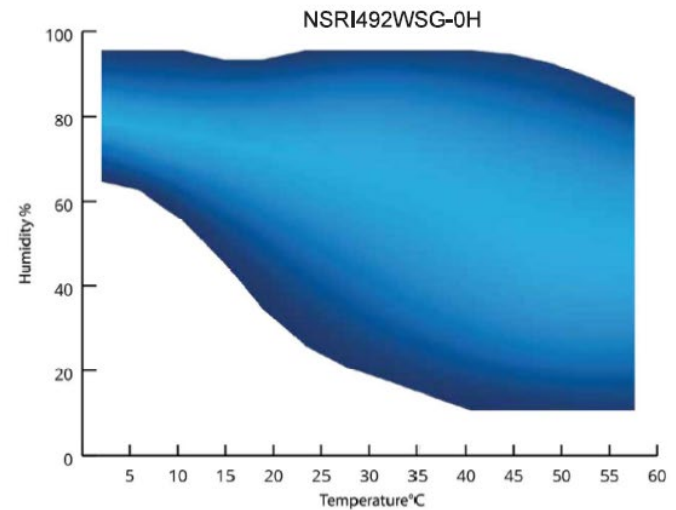
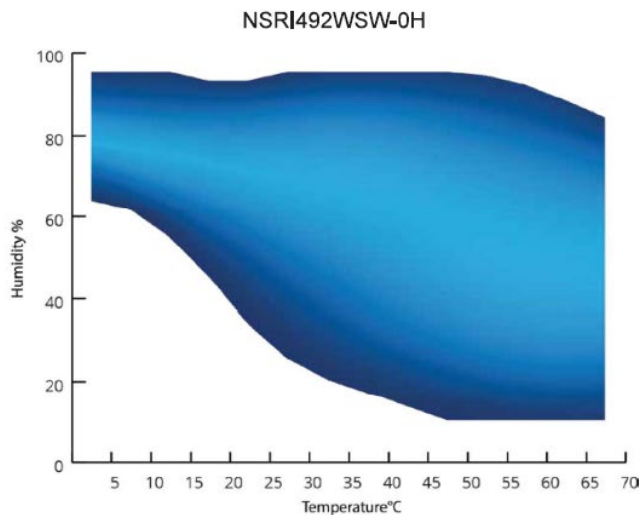
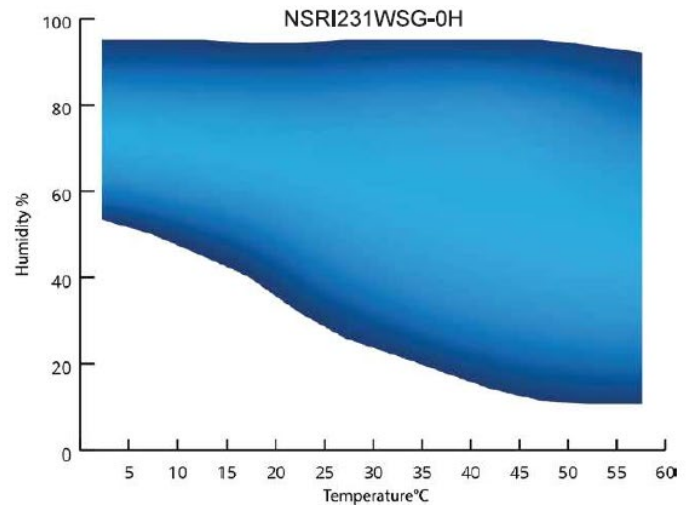
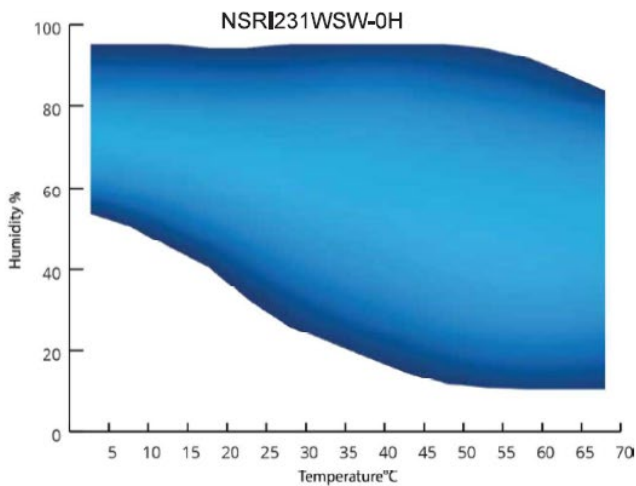

## RECEIVING AND SHIPPING DAMAGE HANDLING

Each refrigerator is carefully inspected to meet our high standard quality assurance policy, before it ships to you. Unfortunately, shipping damage can happen during transportation to you. There are two general types of shipping damage. The first is **visible damage**. This type of damage includes visible loss, damage, shortage or any external evidence of loss or damage that is visible at time of delivery. **This type of damage must be noted in detail on your delivery receipt. Make sure the driver signs and dates the delivery receipt, acknowledging the damages. We also recommend taking many pictures to demonstrate and document the damaged area(s).** This must happen at the time of delivery or it won't happen at all. Keep a copy for your records and send another to the carrier's damage claims department along with a formal request for an inspection report. Follow up with a phone call. Their contact information can be found on the carrier's web site.

The second type of shipping damage is **concealed damage**. This type of damage will probably not be apparent at time of delivery and may not be discovered until unpacking and inspecting the unit. Remember, time is of the essence here. You should unpack and inspect the unit as soon as possible. Each day that passes reduces the likelihood that the carrier will pay the claim. **As soon as the concealed damage is discovered, stop unpacking and retain all packing materials. Take many pictures to demonstrate and document the concealed damage area(s). Contact the carrier by phone to report the claim.** Note the date and time and person you spoke with. Get a claim number. Follow up with a written letter referencing the claim number and including a formal request for an inspection. Again, consult the carrier's website for specific claim instructions and follow them precisely.



**AS STATED ABOVE, THE CARRIER IS YOUR SOLE SOURCE FOR SATISFACTION OF A DAMAGE CLAIM. UNDER NO CIRCUMSTANCES SHOULD THE MERCHANDISE BE RETURNED TO THE MANUFACTURER. NO RETURNS WILL BE ACCEPTED WITHOUT PRIOR AUTHORIZATION.**

## UNPACKING

A fork truck or pallet jack is required! Remove packaging for unobstructed access under the unit.

When using a fork truck, place forks under the unit from the front or rear of the unit. Forks should be set as wide as possible for stability. DO NOT place forks in the center of the unit to avoid the drain centered at the rear of the cabinet. The metal bracket protecting the drain is removable, but only at risk of damaging the drain.

When using a pallet jack, align forks directly in front or back of the unit, making sure to avoid the casters and drain. Lift forks to the same height as the top runners supporting the unit. Slide unit straight forward or backward until casters are free from the skid, then lower unit to the floor.

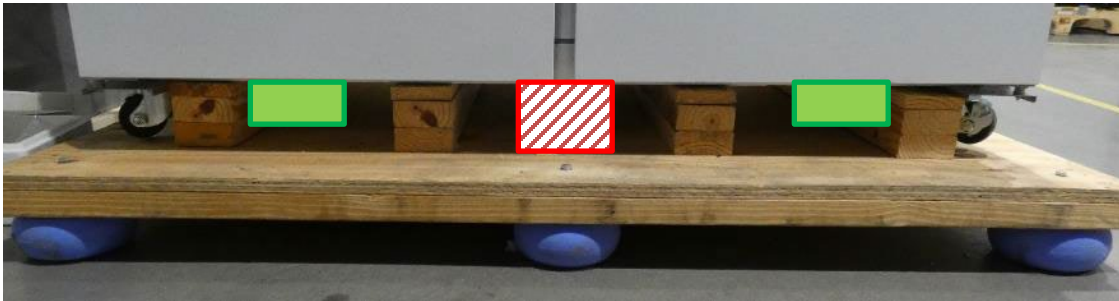

- Remove foam/cardboard shipping supports from underneath plenum inside the chamber prior to powering on unit.

## WARNINGS AND CAUTIONS

- Do not modify cabinet construction or associated equipment assemblies.
- Do not remove labeling or information supplied with the unit.



**Warning: Electric Shock Hazard. Do Not Remove top electrical cover.** Contact a qualified service representative.



**WARNING:** This product can expose you to chemicals including chromium which is known to the State of California to cause cancer and birth defects or other reproductive harm. For more information, go to [www.P65Warnings.ca.gov](http://www.P65Warnings.ca.gov)



### For your safety:

- DO NOT store any unsealed chemical material in this cabinet. Corrosive fumes from chemical material can linger inside of the chamber and cause serious damage to the refrigeration coils. Storing unsealed chemical material in this equipment will void the factory product warranty.
- DO NOT store or use gasoline, or other flammable liquid in this cabinet. This equipment is not rated to be a flammable material storage.
- DO NOT operate this equipment in the presence of explosive fumes.
- This equipment is not rated as a hazardous locations storage cabinet.
- This unit must be properly installed and located in accordance with the Installation Instructions before it is used.
- Do not overload shelves with heavy products, which increases likelihood of items falling and causing injury.
- Do not touch the hot surfaces when the unit is at high temperatures.
- Keep fingers out of the “pinch point” areas; clearances between the doors and between the doors and cabinet are necessarily small; be careful closing doors.
- The controller automatically switches power to devices such as the light circuit, perimeter heaters, or evaporator fans. Always unplug before making repairs.
- While cleaning condenser coil, care should be taken when lifting the canopy to prevent the canopy from falling.

### SPECIFIC TO HYDROCARBON REFRIGERATION (R-290/R600a) ONLY:



**DANGER** - Risk of fire or explosion - flammable refrigerant. Do not puncture refrigerant tubing or use mechanical devices to defrost refrigerator. To be repaired only by trained service personnel.

• **CAUTION** - Risk of fire or explosion – flammable refrigerant. Consult repair manual/owner’s guide before attempting to service this product. All safety precautions must be followed

- CAUTION - Risk of fire or explosion – flammable refrigerant. Dispose of properly in accordance with federal or local regulations
- CAUTION - Risk of fire or explosion if refrigerant tubing is punctured; follow handling instructions carefully
- CAUTION - Proper ventilation must be provided, and all ventilation openings kept free of obstruction

## LOCATION

The cabinet should be located within reach of an outlet that has appropriate power supply as listed above with a protective earth ground. The outlet should be easily accessible when installation is complete as this is the only method for powering off the equipment. The refrigeration system located at the top of the cabinet requires free air access for proper operation. Allow a minimum four-inch clearance on the top, rear, and sides of the cabinet. The floor of the permanent location where the cabinet is located should be level. Uneven floor may prevent the unit casters from rolling or locking properly and may result in rocking or tipping of the cabinet. Do not stack items on top of the unit. Vibration during shipping and handling may loosen mechanical connections. Check all connections during installation.

This unit has been designed for optimal operation in 72° F or 22°C and 50%RH environments at up to 2000 meter elevation. Performance may be impacted if used in other environmental conditions.

## INSTALLATION

**Door Alignment** – Verify that each door is level and opens and closes easily. If adjustment is needed, the bolts for the top hinge bracket may be loosened and moved to properly align the door.

**Product Storage Setup** – The cabinet comes standard with 3 removable sliding trays per door section. Pilasters are factory installed that allow user to select spacing between each tray/shelf.

### Sliding Tray Installation

1. Position support bracket with both hooks inserted completely into the front and back pilaster strips at the same height (level horizontally).
2. Engage white locking tabs at front and back of bracket, making sure bracket is properly secured to both pilasters.
3. Repeat steps 1-2 for opposing support bracket, making sure brackets are at same height on left and right to support both sides of the tray.
4. Position tray so the horizontal supports of both left and right brackets fit into the rear slot of the tray on both sides.
5. Slide tray into cabinet until it reaches the rear stops. Door should be able to close completely with clearance between the door and all trays.

Caution: Care must be taken if extending tray to load/unload product to prevent tray from coming off the support bracket.



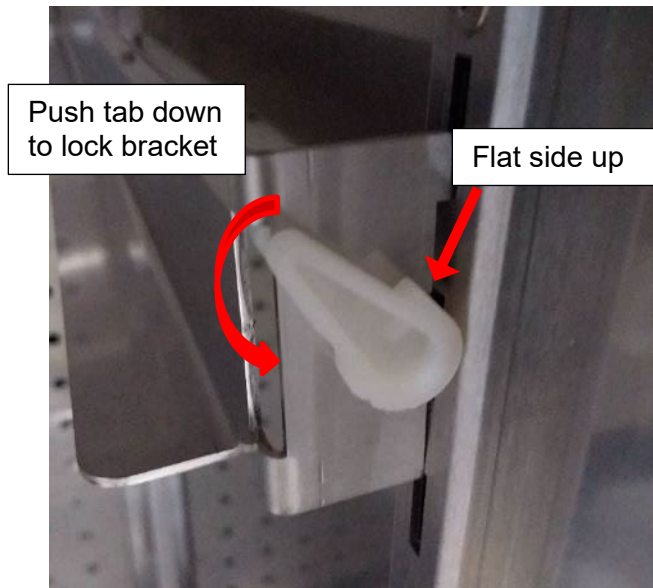

**Remote Alarms Contacts** - The remote alarm contacts terminal block is located at the top of the cabinet on the right side. Terminals are labeled NC (normally closed), COM (Common), and NO (normally open). Terminal connections are rated for class II circuits only per NEC table 11(A). (Limited power source less than 30vac 8 Amp. max, see applicable notes in NEC). End user is responsible for proper field installation.

**RS485 terminals** – The RS485 terminals are located on the same terminal block as the remote alarm contacts. Connect wires to the Rx, Tx, and Gnd terminals per the label.

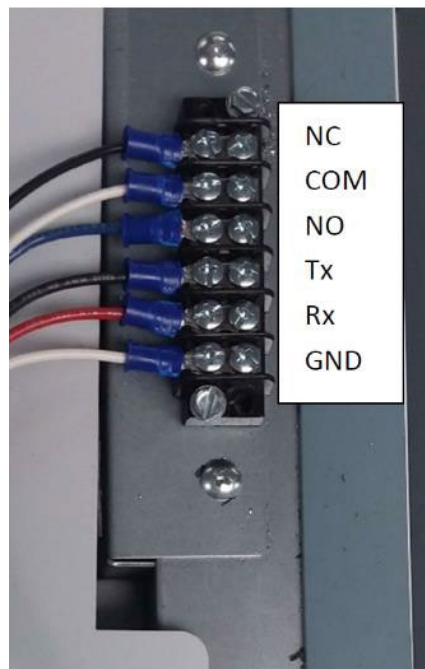

**Duplex Outlet** - (Optional) is located on the back wall of the interior cabinet, centered



left/right near the bottom. This is a 15-amp 115-volt GFCI duplex with its own power supply cord. This outlet has a safety interlock that will interrupt power if a hydrocarbon refrigerant leak is detected within the cabinet. Outlet is not inter-wired thru main cabinet supply and must be plugged into a 115 volt power supply. Locate cabinet within 8 feet of the wall receptacle.

**Access Port 2"** - (Optional) is provided with a spring-loaded cover on the side of the cabinet.

## HUMIDIFIER INSTALLATION



**Important:** in the event of a water leak, disconnect power and repair leak  
**Never** operate humidifier with viewing pane removed, water damage could occur.  
**Never** place hand or other body parts inside humidification reservoir as burns may occur.

Observe all Warning Labels. Disconnect power supply to eliminate injury from electrical shock or moving parts when servicing equipment.

1. Connect 1/4" water tube to water supply on the back of the unit.
2. Connect 3/8" water tube to drain on the back of the unit.
3. Ensure the blue drain valve on the humidifier reservoir is closed.
4. Turn on water supply to fill humidifier reservoir.

### Water supply

De-mineralized water must be used in the ultrasonic humidifier for optimal performance. Reverse Osmosis (RO) or distilled water is recommended. Use of un-clean or high mineral content water will void the warranty. **Only minimal water pressure (5-10PSI) is needed to operate humidifier float valve. Water pressure above 60PSI will need to be reduced, as overflowing may occur.** Water supply temperature may not exceed 33°F to 104°F.



### Important:

Do not add disinfectants or anticorrosive chemicals to the supply water as these are potential irritants. The use of un-treated well water, industrial water and or water from cooling circuits and in general any potentially chemically or bacteriologically contaminated water is prohibited.

## DRAIN INSTALLATION

The cabinet has a floor drain in the bottom of the cabinet. A silicone drain stopper has been placed in this drain. The drain stopper will prevent undesirable liquids from running into the drain. The stopper can be removed if any possible liquids flowing into this drain are acceptable to go to the floor drain.

The cabinet also has a drain fitting located on the back wall approximately 4 feet above the floor. Condensation collected by the refrigeration system is removed from the cabinet via this drain.

Both cabinet fittings are connected via hose to a hose barb tee behind the cabinet. The drains should be run to an atmospheric floor drain to prevent drain water from collecting on the floor around the cabinet. A length of 1/2" I.D. drain hose is shipped inside cabinet. Attach this hose to the open fitting of the tee with the supplied clamp and run to an atmospheric floor drain. A longer drain hose may be substituted as needed.

## ELECTRICAL INSTALLATION

Check the proposed external power outlet/supply to be used to ensure that the voltage, phase and current carrying capacity of the circuit from the electrical panel correspond to the requirements of the cabinet.

- The supply circuit to this cabinet must conform to NEC (National Electrical Code). Consult the cabinet Serial-Data plate for voltage, cycle, phase, and amp requirements before making connection.
- SUPPLY VOLTAGE SHOULD NOT VARY MORE THAN 5% FROM SERIAL PLATE RATINGS.
- DO NOT connect this equipment to a GFI (Ground Fault Interrupt) circuit.
- **Do not use an extension cord or any multi-outlet strip or plug.** Using such devices can lead to insufficient power and component failure, such as the compressor or starting components.
- If the power cord is damaged, it should be replaced immediately by an authorized service technician.

Be sure your unit is properly grounded. Use the 3-prong plug provided into a 3-prong grounded outlet. Unless the above grounding method is followed, you are not protected against severe or lethal shock in the event of a short circuit of an electrical component or wiring of the unit.

**⚠ WARNING** Avoid fire hazard or electric shock. Do not use an extension cord or an adapter plug. Do not remove any prong from power cord.

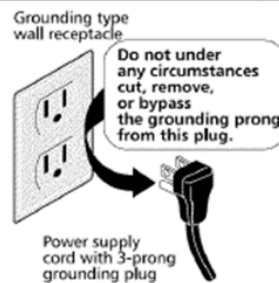

## OPERATION

The stability chambers are designed for use in a controlled environment. This unit has been designed for ambient conditions of 72°F with 50%RH at up to 2000-meter elevation.

These units employ a programmable controller to control the temperature and humidity settings. The controller, which is located on the canopy of the unit, is factory set for best performance across a broad range of settings. Adjustments may be made to optimize operation for a particular temperature or humidity setpoint. Refer to the next section for details on the operation of the controller.

Temperature control is achieved by balancing the cooling effect of the refrigeration system with electric heat. Heating and cooling may be varied in different ways to achieve temperature stability. The refrigeration system consists of the main cooling loop and the dehumidification loop, both tied to the single variable speed compressor. Two separate heater banks, located below the main evaporator coil and behind the main evaporator coil, receive independent proportional control signals that vary between full heat and no heat output. As a safety measure, a set of high-temperature safety switches are located near the heat source to interrupt power to the heater if the temperature exceeds 85°C. If the safety switches are tripped, power will automatically be restored to the heaters once the temperature near the heat source falls below 65°C.

Once temperature stability is achieved, the humidity control is enabled to allow for humidification or dehumidification as needed to maintain a certain humidity level. If measured air temperature within the chamber is not within range of setpoint (typically within 0.8°C), humidity control is disabled until the temperature is restored to within range of setpoint. Humidification is achieved via ultrasonic pucks, controlled independent of the heating or cooling conditions.

The refrigeration system is modified to service both cooling and dehumidification, either independently or simultaneously. Cooling is activated via the cooling solenoid valve, which opens to allow refrigerant to flow to the main evaporator coil. Dehumidification is activated via the dehumidification solenoid valve, which opens to send refrigerant to the dehumidification loop (aka rear coil). When the compressor is running, at least one solenoid must be open to allow a path for refrigerant to flow. The solenoids may be open simultaneously or switch back and forth to achieve the desired performance.

# PROGRAMMABLE CONTROLLER

## TABLE OF CONTENTS

<b>CONTROLLER OVERVIEW .....</b>	<b>13</b>
<b>STARTING UP AND OPERATING THE CONTROLLER .....</b>	<b>14</b>
SET POINTS .....	16
RAMP AND SOAK SCHEDULE .....	20
PARAMETERS .....	23
QUALITY CONTROL .....	30
ALARM TEST .....	31
ALARMS .....	32
USB PORT .....	33

## CONTROLLER OVERVIEW

### FRONT PANEL VIEW

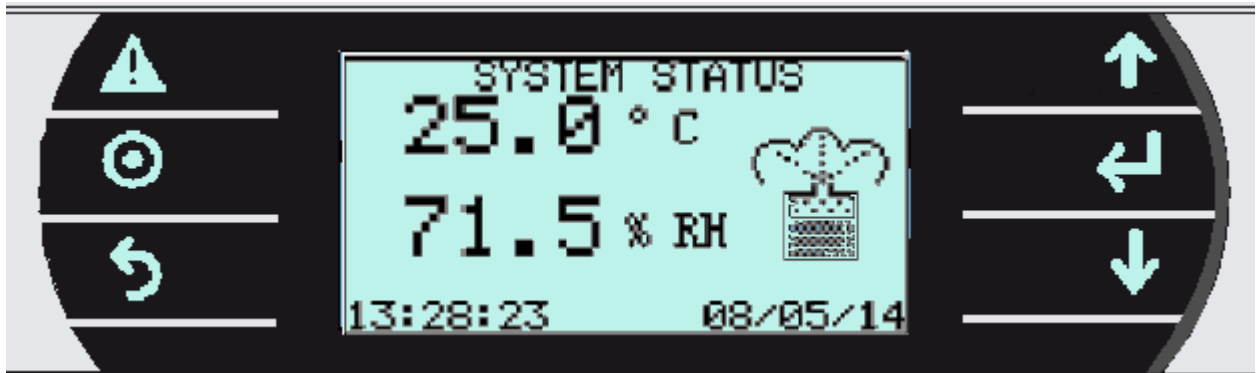

### KEY FUNCTIONS



**ALARM KEY:** Displays active alarms, alarm history, acknowledge alarms, and clear alarms. Back lit when an alarm is active.



**PROGRAM KEY:** Allows access to set points and main control parameters.



**ESCAPE KEY:** Returns to the main menu (SYSTEM STATUS).



**DOWN KEY:** Decreases parameter values, and scrolls through screens.



**ENTER KEY:** Moves the cursor between parameter fields and confirms the set data.



**UP KEY:** Increases parameter values and scrolls through screens.

## STARTING UP AND OPERATING THE CONTROLLER



Initial screen: Press  ENTER key to display.

KEY:  *ESCAPE*

Pressing the  **Escape** key will display the following screen. The SYSTEM STATUS screens are display only. To change set points, use the setup. To view the other SYSTEM STATUS screens, press the UP or Down Arrow keys.

Note: The main system status screen will change in appearance depending on what options are enabled in the control. The following three screens show what the main system status screen will look like with different options.



Atomizer on.



Dehumidification on.

This screen displays the product temperature, relative humidity, and current date and time.



```
AIR TEMP: 25.5°C
Comp: 94 Hz
HEATING: Bottm 39.9%
        Back 39.9%
DEHUMIDIFICATION ON
```

This screen shows the control probe reading, the resultant variable frequency which drives the compressor and hence the refrigeration, the percentage output of the electric heaters and the status of humidity control (humidification/dehumidification).

```
COMPRESSOR STATUS
AMBIENT TEMP: 24.8°C
Cool Enabled
COOLING ON
DEHUMID Enabled
```

This screen shows the ambient probe reading and the status of both the main and auxiliary refrigeration systems

```
CURRENT SETPOINTS
TEMPERATURE: 25.0°C
HUMIDITY: 50.0%RH
```

This screen displays the current set points.



KEY:  PROGRAM

Pressing the  Program key will display the following screen.

```
SETUP MENU
SETPOINTS >
PARAMETERS >
SENSOR TEST >
```

This screen allows access to the listed set up screens. Press the  Enter to move the cursor to the desired field and press the Up or Down Arrow key to select the screens of each group.



**Note: For all screens that allow values or parameters to be changed, navigation will follow this sequence:**

Press the  Enter key to move the cursor between data fields that may be set by the user. Use the Up or Down Arrow key to increase or decrease the value of the selected data field. When the correct value or selection is displayed press the  Enter key to confirm the selection, which moves the cursor will to the next field. When the cursor is in the upper left-hand corner, press the Up or Down Arrow key to scroll through the other screens within the menu or press the  Escape key to return to the System Status screen.

## SET POINTS

Note: If password protection is used, the following screen will be displayed before allowing access to the SET POINTS screens. On initial start-up there is no password protection. The passwords are set in the PARAMETERS group. If no password protection is used the "ENTER PASSWORD" screen will not be displayed.



Press the  Enter key to move the cursor to the four-digit password. Use the Up or Down Arrow key to increase or decrease the number. When the correct password is displayed press the  Enter key to enter the password. If the correct password was entered the corresponding Set Points screen will be displayed. If a wrong password was entered "WRONG PASSWORD" will be displayed on the bottom line. The password can be re-entered or press the  Escape key to return to the System Status screen.

SET POINTS: Screen 1

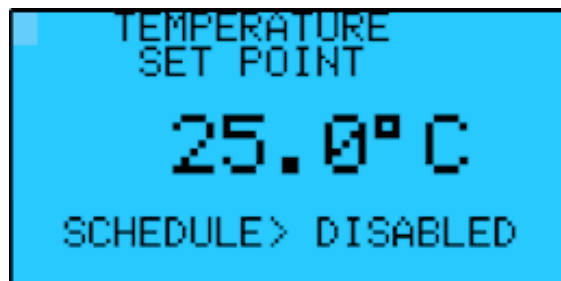

**Note: If the schedule is enabled, the temperature will not be displayed on this screen and must be set through the ramp and soak schedule. To disable the ramp and soak schedule press the ENT key to move the cursor to the schedule field. Use the Up or Down Arrow key to disable the schedule. Press the ENT key and the cursor will move to the upper left-hand corner and the set point value will be visible. A full explanation of the ramp and soak schedule follows.**

SET POINTS: Screen 2

Note: The following screen will only be visible if the humidity is enabled in the Parameter section.



SET POINTS: Screen 3



Factory Default Setting: High Alarm 75.0°C  
Factory Default Setting: Low Alarm 0.0°C  
Factory Default Setting: Alarm Delay 120 Sec

Note: The High and Low Air Temperature Alarms provide an early warning prior to the product temperature alarm. They should be set to allow the normal rise and fall of the air temperature during normal operation. High ambient temperature and heavy door use may require a longer Alarm Delay. The ALARM DELAY is the amount of time in seconds that the temperature must be above or below the alarm set point for the alarm to activate.

SET POINTS: Screen 4

Note: The following screen will only be visible if the Humidity is enabled in the Parameter section.



Factory Default Setting: High Alarm 100.0%  
Factory Default Setting: Low Alarm 1.0%  
Factory Default Setting: Alarm Delay 120 Sec

Note: The ALARM DELAY is the amount of time in seconds that the humidity level must be above or below the alarm set point for the alarm to activate.

SET POINTS: Screen 5

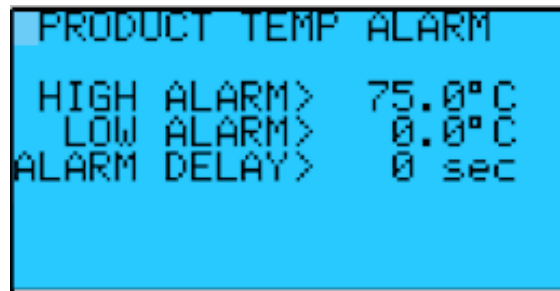

```
PRODUCT TEMP ALARM
HIGH ALARM> 75.0°C
LOW ALARM> 0.0°C
ALARM DELAY> 0 sec
```

Factory Default Setting: High Alarm 75.0°C  
Factory Default Setting: Low Alarm 0.0°C  
Factory Default Setting: Alarm Delay 0 Sec

Note: The ALARM DELAY is the amount of time in seconds that the temperature must be above or below the alarm set point for the alarm to activate.

SET POINTS: Screen 6

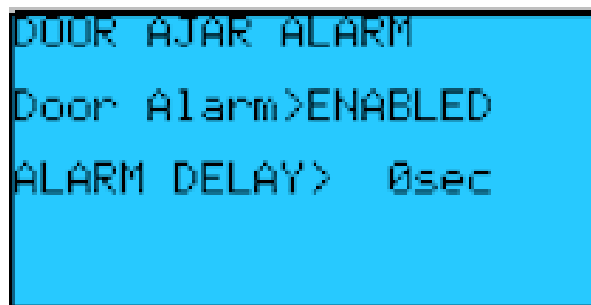

```
DOOR AJAR ALARM
Door Alarm>ENABLED
ALARM DELAY> 0sec
```

DOOR AJAR ALARM: Enables or disables the door ajar alarm.

DELAY: The amount of time in seconds that the door must be open before the alarm activates.

SET POINTS: Screen 7

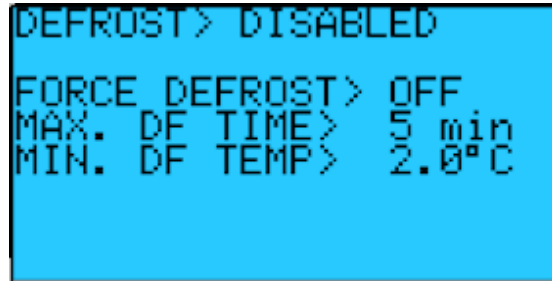

```
DEFROST > DISABLED
FORCE DEFROST > OFF
MAX. DF TIME > 5 min
MIN. DF TEMP > 2.0°C
```

Factory Default Setting: FORCE DEFFOST > OFF  
Factory Default Setting: MAX. DF TIME > 5min  
Factory Default Setting: MIN. DF TEMP > 2.0°C

Note: This setting will be applicable to cabinets which will maintain setpoints that may lead to frozen evaporator coils. DEFROST enables or disables the defrost function. FORCE DEFROST bypasses the schedule and puts the system in defrost mode. MAX. DF TIME is the duration of one defrost cycle. MIN DF TEMP is the temperature reading above which defrost will not be activated

SET POINTS: Screen 8

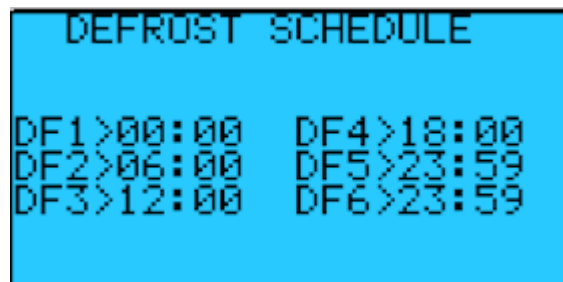

```
DEFROST SCHEDULE
DF1 > 00:00   DF4 > 18:00
DF2 > 06:00   DF5 > 23:59
DF3 > 12:00   DF6 > 23:59
```



Factory Default Setting: See above (4 defrosts, every 6 hours)

Note: This schedule will only apply if DEFROST is enabled.

## RAMP AND SOAK SCHEDULE

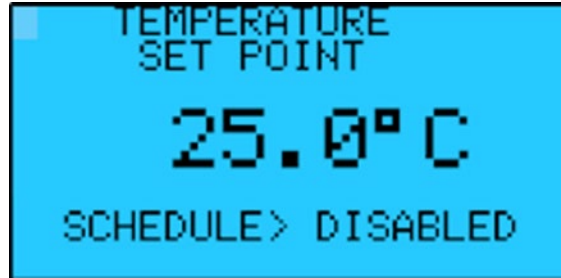
SET POINTS: Screen 1



Press the  Enter key to move the cursor to the schedule field. Use the Up or Down arrow key to enable the schedule. Press the  Enter key and the first of 21 Ramp and Soak screens will be displayed.

### RAMP & SOAK





Time

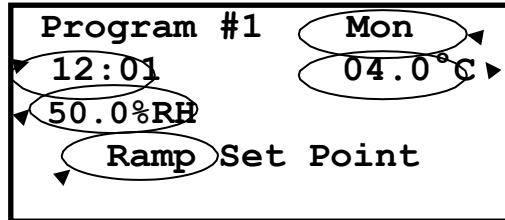

Humidity Set Point

Ramp/Hold:  
Ramp Set Point or  
Hold Set Point



Weekly/Daily:  
Daily, Mon, Tues,  
Wed, Thur, Fri,  
Sat, Sun.  
Temperature Set Point

Press the  Enter key and the cursor moves to the Day of the Week/Daily field. Use the Up or Down arrow key to select daily or the day of the week the schedule is to begin. Press the  Enter key and the cursor will move to the time field. Use the Up or Down arrow key to enter the desired time to change the set points. Press the  Enter key and the cursor will move to the temperature set point field. Use the Up or Down arrow key to enter the desired temperature set point. Press the  Enter key and the cursor will move to the humidity set point field (if activated). Use the Up or Down arrow key to enter the desired humidity set point. Press the  Enter key and the cursor will move to the light set point field (if activated). Use the Up or Down arrow key to enter the desired lighting set point.

Press the  Enter key and the cursor will move to the Ramp / Hold field. Use the Up or Down arrow key to select to Ramp the set point to the next scheduled set point or to Hold the set point until the next scheduled set point. Press the  Enter key and the cursor will move to the upper left-hand corner. Press the Down arrow key to go to the next schedule.

Note: If Daily is selected on the Program #1 screen programs 1 through 21 will repeat each day. Any unused programs will have to be turned off.



### **Ramp and Soak Example**

The following example will ramp from 4.0°C to 10.0°C every Monday from 06:00 to 12:00. The temperature will remain at 10.0°C until Wednesday at 06:00 when it will begin ramping the set point down to 4.0°C at 12:00 Wednesday. The set point will remain at 4.0°C until Friday at 06:00 when it will begin ramping the set point up to 10.0°C at 12:00 Friday. The set point will remain at 10.0°C until Sunday at 06:00 when it will begin ramping the set point down to 4.0°C at 12:00 Sunday. The temperature set point will remain at 4.0°C until the schedule repeats Monday at 06:00.



It is recommended to fill out the Ramp and Soak worksheet on page 26 of this manual before programming the ramp and soak functions of the controller.

<b>Program #</b>	<b>Daily/Weekly</b>	<b>Time</b>	<b>Temp.</b>	<b>Humidity</b>	<b>Lights</b>	<b>Ramp/Hold</b>
1	Mon.	6:00	4.0°C	N/A	N/A	Ramp
2	Mon.	12:00	10.0°C	N/A	N/A	Hold
3	Wed.	6:00	10.0°C	N/A	N/A	Ramp
4	Wed.	12:00	4.0°C	N/A	N/A	Hold
5	Fri.	06:00	4.0°C	N/A	N/A	Ramp
6	Fri.	12:00	10.0°C	N/A	N/A	Hold
7	Sun.	06:00	10.0°C	N/A	N/A	Ramp
8	Sun.	12:00	4.0°C	N/A	N/A	Hold
9	Off			N/A	N/A	
10	Off			N/A	N/A	
11	Off			N/A	N/A	
12	Off			N/A	N/A	
13	Off			N/A	N/A	
14	Off			N/A	N/A	
15	Off			N/A	N/A	
16	Off			N/A	N/A	
17	Off			N/A	N/A	
18	Off			N/A	N/A	
19	Off			N/A	N/A	
20	Off			N/A	N/A	
21	Off			N/A	N/A	

## PARAMETERS

Note: If the password protection is used the following screen will be displayed before allowing access to the PARAMETERS screens. On initial start-up there is no password protection. The passwords are set in the PARAMETERS group. If no password protection is used the “ENTER PASSWORD” screen will not be displayed.



Press the  Enter key to move the cursor to the four-digit password. Use the Up or Down Arrow key to increase or decrease the number. When the correct password is displayed press the  Enter key to enter the password. If the correct password was entered the corresponding screen will be displayed. If a wrong password was entered “WRONG PASSWORD” will be displayed on the bottom line. The password can be re-entered or press the  Escape key to return to the System Status screen.

PARAMETERS: Screen 1



PARAMETERS: Screen 2

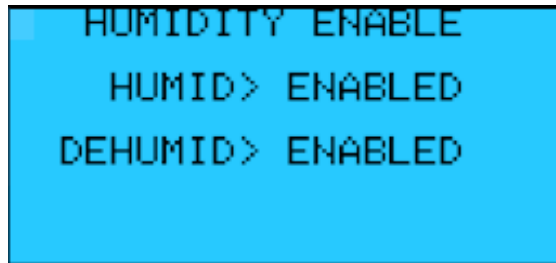

```
HUMIDITY ENABLE
HUMID > ENABLED
DEHUMID > ENABLED
```

Note: This setting allows the user to enable or disable humidification or dehumidification if needed. Both are enabled by default.

PARAMETERS: Screen 3

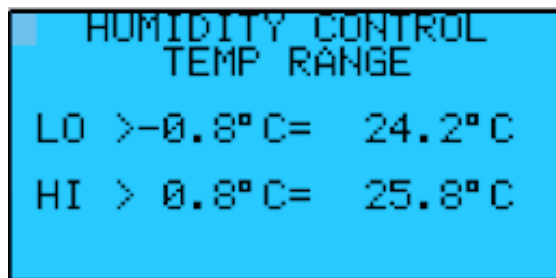

```
HUMIDITY CONTROL
TEMP RANGE
LO > -0.8°C = 24.2°C
HI > 0.8°C = 25.8°C
```

Factory Default Setting: Humidity Control Temp LO > -0.8°C  
Factory Default Setting: Humidity Control Temp HI > +0.8°C

Note: These settings define the temperature offset below (LO) or above (HI) the setpoint where humidification or dehumidification are enabled. Humidity control will not function when air temperature within the cabinet is outside of this range.

PARAMETERS: Screen 4

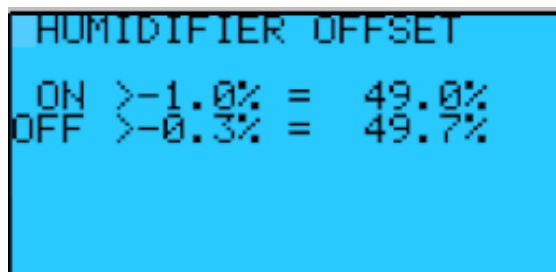

```
HUMIDIFIER OFFSET
ON > -1.0% = 49.0%
OFF > -0.3% = 49.7%
```

Factory Default Setting: ON > -1.0%  
Factory Default Setting: OFF > -0.3%

ON: Is the offset from the actual Humidity Set Point where the humidifier will turn on.  
OFF: Is the offset from the actual Humidity Set Point where the humidifier will turn off.

PARAMETERS: Screen 5

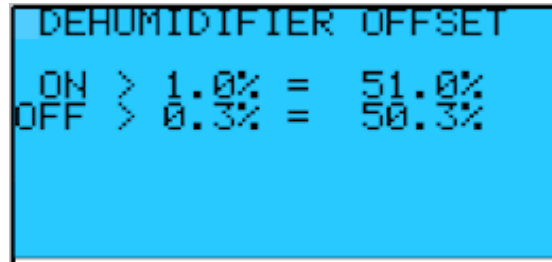

Factory Default Setting: ON> 1.0%  
Factory Default Setting: OFF> 0.3%

ON: Is the offset from the actual Humidity Set Point where the dehumidifier will turn on.  
OFF: Is the offset from the actual Humidity Set Point where the dehumidifier will turn off.

PARAMETERS: Screen 6

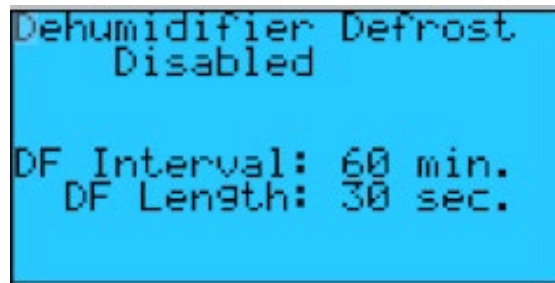

Factory Default Setting: DF Interval > 60 min  
Factory Default Setting: DF Length > 30 sec

DEFROST: Enables or disables the defrost cycle of the dehumidification evaporator coil.  
DF Interval: Amount of time, in minutes that the dehumidification coil must be active to initiate an off cycle defrost.  
DF Length: The length in seconds of the defrost cycle.

PARAMETERS: Screen 7



Factory Default Setting: TONE >  
CONSTANT  
Factory Default Setting: RING-BACK > 20  
min

TONE: The sound of the audible alarm can be any of these: constant, intermittent slow or intermittent fast  
RING-BACK: Time in minutes between dismissing an alarm and when it resounds if the alarm condition is still present

PARAMETERS: Screen 8



LEVEL 1: Password protection for the SET POINT and SENSOR TEST screens.  
LEVEL 2: Password protection for the PARAMETERS screens.

**IMPORTANT NOTE:** The use and selection of Passwords is RECOMMENDED to protect the system from intentional or inadvertent tampering. If the passwords are not utilized, there will not be password prompting during programming. This is very dangerous as the factory settings, designed to protect personnel and property, are left exposed to tampering

PARAMETERS: Screen 9



UNIT IDENT: Sets the unit identification for serial communications.  
BAUD RATE: Sets the Baud Rate for the serial communications. Baud rates supported 1200, 2400, 4800, 9600, & 19200.

PARAMETERS: Screen 10

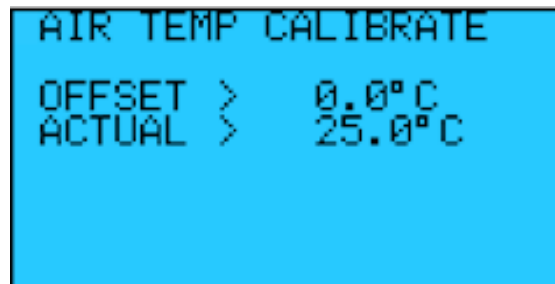

OFFSET: Allows calibration for the Air Temperature Sensor.  
ACTUAL: Displays the current sensor reading.

PARAMETERS: Screen 11

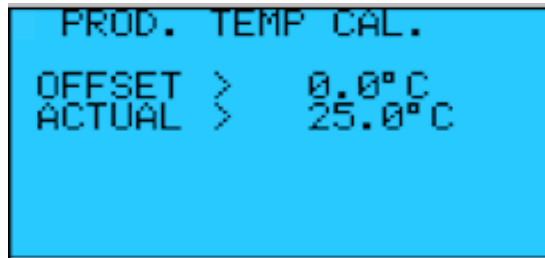

```
PROD. TEMP CAL.  
OFFSET > 0.0°C  
ACTUAL > 25.0°C
```

OFFSET: Allows calibration for the Product Temperature Sensor.  
ACTUAL: Displays the current sensor reading.

PARAMETERS: Screen 12

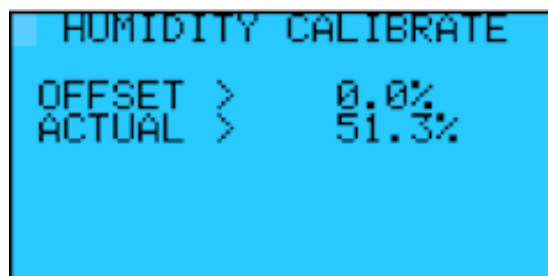

```
HUMIDITY CALIBRATE  
OFFSET > 0.0%  
ACTUAL > 51.3%
```

OFFSET: Allows calibration for the Humidity Sensor.  
ACTUAL: Displays the current sensor reading.

PARAMETERS: Screen 13

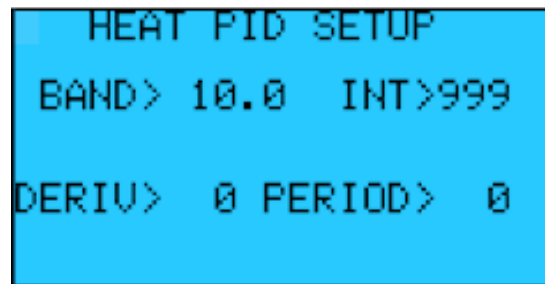

```
HEAT PID SETUP  
BAND > 10.0 INT > 999  
DERIV > 0 PERIOD > 0
```

HEAT PID BAND: Control band (°C) for the Heating PID. A band of 10.0 means the heat is varied proportionally between 5.0°C above and 5.0°C below the setpoint. Outside of this band, heating is at its maximum or minimum.

HEAT PID INTEGRAL: Integral time constant (sec.) for Heating PID. Larger values slow the integral adjustment of the PID, while smaller values speed up the integral adjustment. (0 = no integral)

HEAT PID DERIVATIVE: Derivative time constant (sec.) for Heating PID. Larger values slow the derivative adjustment, while smaller values speed up the derivative adjustment. (0 = no derivative)

HEAT PID PERIOD: Time period (milliseconds) that elapses between updating heat output. (0 = no delay between updates)

PARAMETERS: Screen 14

```
Cool PID SETUP
BAND> 10.0  INT>999
DERIV> 0 PERIOD> 0
```

**COOL PID BAND:** Control band (°C) for the variable frequency compressor. A band of 10.0 means the compressor frequency is varied proportionally between 5.0°C above and 5.0°C below the setpoint. Outside of this band, frequency is at its maximum or minimum.

**COOL PID INTEGRAL:** Integral time constant (sec.) for the variable frequency compressor. Larger values slow the integral adjustment of the PID, while smaller values speed up the integral adjustment. (0 = no integral)

**COOL PID DERIVATIVE:** Derivative time constant (sec.) for the variable frequency compressor. Larger values slow the derivative adjustment, while smaller values speed up the derivative adjustment. (0 = no derivative)

**COOL PID PERIOD:** Time period (milliseconds) that elapses between updating the variable frequency output

PARAMETERS: Screen 15

```
Cool Pulse SETUP
Cool pulse>DISABLED
C_pulse Duration>
C_pulse Interval>
```

**COOL PULSE ENABLE/DISABLE:** Enables or disables the refrigeration cycling when chasing a higher than average relative humidity and the main evaporator is required to achieve temperature stability

**COOL PULSE DURATION:** The length of the off time when cycling the refrigeration system to achieve high humidity

**COOL PULSE INTERVAL:** The length of time between each on-off cycle when pulsing is enabled



PARAMETERS: Screen 16

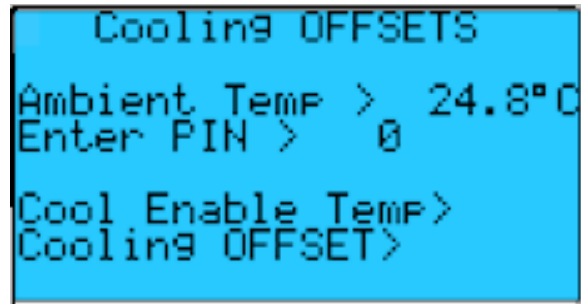

```
Cooling OFFSETS
Ambient Temp > 24.8°C
Enter PIN > 0
Cool Enable Temp >
Cooling OFFSET >
```

This configuration is enabled upon password entry and locked otherwise.

Ambient Range Cooling ENABLE TEMPERATURE: Used to set threshold for when compressor is continuously cooling. Above this temperature, continuous cooling is disabled.

Ambient Range Cooling OFFSET: The allowable window of increase in temperature before turning on the main coil when setpoint is close to ambient

PARAMETERS: Screen 17

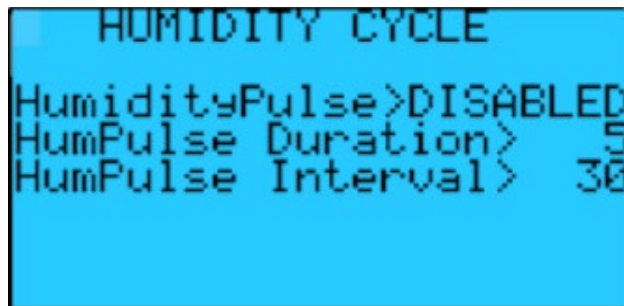

```
HUMIDITY CYCLE
HumidityPulse > DISABLED
HumPulse Duration > 5
HumPulse Interval > 30
```

HUMIDITY PULSE ENABLE/DISABLE: Enables or disables the humidifier cycling when there is little need to add humidity to attain the humidity setpoint

HUMIDITY PULSE DURATION: The length of the off time when cycling the humidifier to achieve humidity setpoint

HUMIDITY PULSE INTERVAL: The length of time between each on-off cycle when humidity pulsing is enabled

## **QUALITY CONTROL**

The following is a recommended procedure for quality control of this cabinet. If other regulations require control in excess of this procedure, the more stringent guidelines should apply.

### *ACTUAL TEMPERATURE*

The display temperatures should be validated on start-up and periodically thereafter to assure that the unit is performing to the requirements. Validation can be accomplished by utilizing a NIST (National Institute of Standards and Technology) traceable thermometer.



The air temperature can be validated by placing the thermometer on a shelf or drawer, so the thermometer is not in direct contact with any metal surfaces. The displayed Air Temperature should read within  $\pm 1^{\circ}\text{C}$  of the NIST Thermometer. If the displayed Air Temperature is out of range enter an offset in the Air Temperature Calibration screen.

Next place the NIST Thermometer in a medium that simulates the product being stored (such as water or a closed cardboard box). Allow the medium and thermometer temperature to equalize before comparing the displayed product temperatures and thermometer reading. The displayed Product Temperature should read within  $\pm 1^{\circ}\text{C}$  of the NIST Thermometer. If the displayed Product Temperature is out of range enter an offset in the Product Temperature Calibration screen.

## ALARM TEST

Note: If the password protection is used the following screen will be displayed before allowing access to the ALARM TEST screen. On initial startup there is no password protection the passwords are set in the PARAMETERS group. If no password protection is used the "ENTER PASSWORD" screen will not be displayed.



Press the  Enter key to move the cursor to the four-digit password. Use the Up or Down Arrow key to increase or decrease the number. When the correct password is displayed press the  Enter key to enter the password. If the correct password was entered the corresponding screen will be displayed. If a wrong password was entered "WRONG PASSWORD" will be displayed on the bottom line. The password can be re-entered or press the  Escape key to return to the System Status screen.

## ALARM TEST

The Alarm Test feature of this controller will test the High and Low Temperature Alarms for the two product temperature sensors.

P1 LO TEMP TEST: Upper product sensor low temperature alarm test.  
P1 HI TEMP TEST: Upper product sensor high temperature alarm test.

When the test is active the temperature will begin to rise for the high temperature alarm tests and fall for the low temperature alarm tests. The temperature will continue to rise or fall for three (3) minutes then the test will be stopped. When the temperature reaches the Alarm Set Point for the selected sensor the alarm will sound, and the display will show the alarm. The Alarm History Screen will log the temperature, time and date that the alarm occurred.

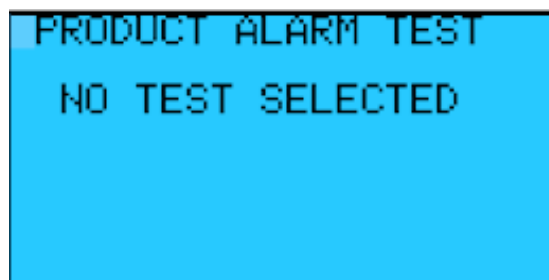

Press the ENT key to move the cursor to the NO TEST SELECTED data field. Use the Up or Down Arrow key to scroll through the tests. When the correct test is displayed press the ENT key to start the test. Press the ESC key to return to the System Status screen.

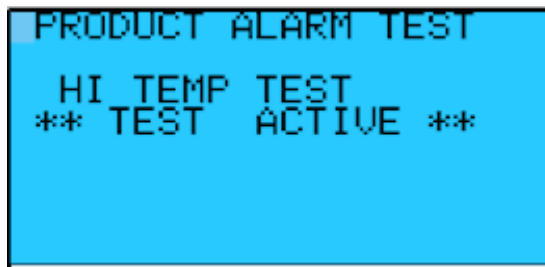

This screen will be displayed when a test is active. To end a test press the ENT key to move the cursor to the TEST data field and use the Up or Down Arrow key to scroll through the tests until “NO TEST SELECTED” is displayed. Press the ENT key to end the test.

## ALARMS

During normal operation, should an alarm occur, the ALARM button will **glow red** and an **audible buzzer** will sound to indicate the presence of the alarm. Pressing the ALARM button once will silence the buzzer for the period of time set for the RING BACK. If the alarm is still active after the RING BACK time has expired the buzzer will sound again. Pressing it again will bring up the first alarm screen. Successive presses of the ALARM button will bring up each alarm screen in sequence until the final screen indicating “NO MORE ALARMS, PRESS ENTER TO CLEAR ALARM”. Pressing the ENTER button on the final screen then returns you to the screen that was being displayed when the alarm sounded. Most alarms are self-explanatory.

During normal operation, when no alarms are active, pressing the ALARM button will display the Alarm History screen:



The ALARM HISTORY screen will display the last alarm that has occurred. The controller will store the last 100 alarms that have occurred. To view the Alarm History Log, press the ENT button to move the cursor to the alarm #. Using the UP and Down Arrow buttons scroll through the stored alarms.

Each alarm will display the date and time of the alarm along with the product temperature (P1) when the alarm occurred.

## USB PORT

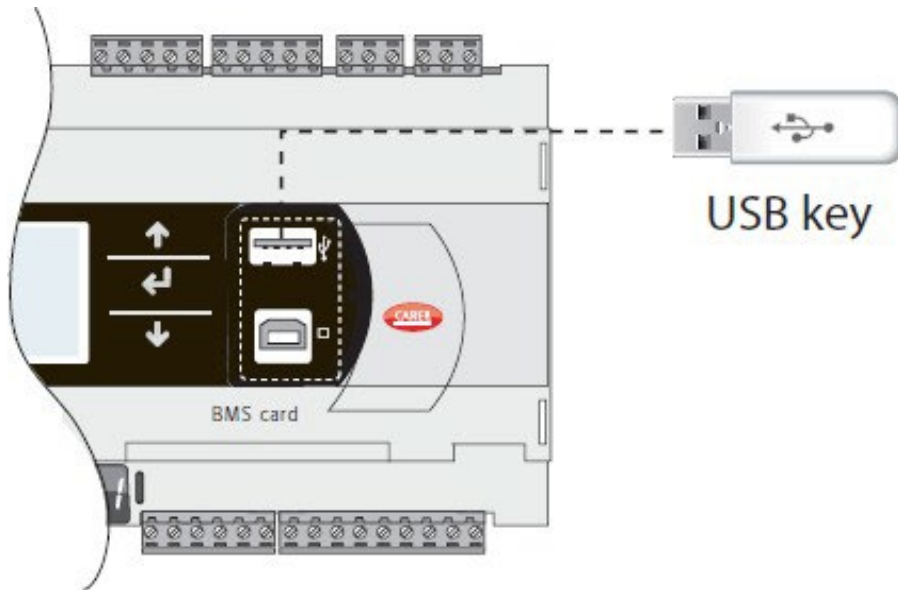

The USB port is intended for flash drives (USB key) only. Flash drive must be formatted as FAT32.

The USB port may be used to:

1. Download Application (re-program controller)
2. Upload Application (copy program to another controller)
3. Upload data files for troubleshooting or technical service.

Contact technical service for assistance using the USB port.

**Ramp and Soak Worksheet**

<b>Program #</b>	<b>Daily/ Day of Week</b>	<b>Time</b>	<b>Temp.</b>	<b>Humidity</b>	<b>Ramp/Hold</b>
1					
2					
3					
4					
5					
6					
7					
8					
9					
10					
11					
12					
13					
14					
15					
16					
17					
18					
19					
20					
21					

## MAINTENANCE



**Observe all Warning Labels. Disconnect power supply(s) to eliminate injury from electrical shock or moving parts when servicing equipment.**

### PERIODIC CLEANING

Disconnect power source, including optional duplex power cord if equipped, before servicing or cleaning.

- Never use abrasive cleaners or instruments (steel pads, wire brushes, etc.) on stainless steel interior or powder coated exterior
- Never use acid-based cleaners, which will damage the stainless finish. Warm soapy water is best, but if cleaning solution is required, use only alkaline based cleaners.
- Avoid chlorides during cleaning which could damage the stainless-steel finish. Chlorides are commonly found in hard water, salts, and household or industrial cleaners. If cleaners with chlorides are used, rinse with clean water and dry thoroughly.
- Gaskets should be cleaned only with warm soapy water. Cleaning products could damage gaskets or cause them to brittle over time. Never use tools which could cut or tear the gasket.
- Drain lines to evaporator pan and or floor drain should be inspected for blockage or leaks.

Monthly cleaning of the condenser will aid the heat transfer characteristics of the refrigeration system and increase its efficiency. Dust, dirt, and lint may accumulate on the fins of the condensing unit. This obstruction may affect the flow of air through the condenser, thereby lowering the efficiency of the system. A soft bristle can be used to loosen these particles that are attached to the fins so that they may be removed with a vacuum cleaner. Care must be taken not to bend the fins, which could restrict air flow.

**Important: Failure to keep the condenser coil clean and clear of obstructions could result in temperature loss and damage to the compressor.**

All moving parts have been permanently lubricated and will generally require no maintenance.

### HUMIDIFIER MAINTENANCE

#### PERIODIC CLEANING

In normal conditions, the tank and ultrasonic generators require periodic maintenance. Normal conditions would be up to 3000 hours if cleaned periodically, or if unit is not used for an extended period or if problems should occur.

**Monthly** or sooner depending on water quality and operational hours, no more than 250 hours completely drain and flush water from vaporization tank by turning blue valve.

**Yearly** or sooner depending on water quality and operational hours, no more than 1500 hours clean or replace ultrasonic discs and confirm proper operation of float valve.



**Disc replacement procedure:**

4. Disconnect humidifier from power
5. Turn off water supply
6. Completely drain water from vaporization tank by turning blue valve
7. Remove viewing ring and window by removing screws
8. Remove winding ring to expose ceramic disc
9. Replace disc (caution make sure gaskets are properly seated)
10. Reinstall viewing ring and window, turn water on and restore power

**Disabling the humidifier in the event of non-use:**

1. Turn off the water supply
2. Open blue drain valve
3. Disable humidity in parameters screen on controller

**Technical Service contact:**

Telephone: 1.800.648.4041 (Option 5)

Fax: 1.843.821.8051

**Replacement Parts contact:**

Telephone: 1.800.648.4041 (Option 4)

Fax: 1.843.821.8051

# MAINTENANCE SERVICE AND ANALYSIS GUIDE

## MALFUNCTION

## POSSIBLE CAUSE

## SOLUTION

Compressor will not start - no hum	<ol style="list-style-type: none"> <li>1. Service cord unplugged</li> <li>2. Overload tripped</li> <li>3. Control stuck open</li> <li>4. Wiring incorrect</li> </ol>	<ol style="list-style-type: none"> <li>1. Plug in service cord</li> <li>2. Determine reasons and correct</li> <li>3. Repair or replace</li> <li>4. Check wiring against the diagram</li> </ol>
Compressor will not start - hums but trips on overload protector	<ol style="list-style-type: none"> <li>1. Improperly wired</li> <li>2. Low voltage to unit</li> <li>3. Inverter malfunction</li> <li>4. Relay failing to close</li> </ol>	<ol style="list-style-type: none"> <li>1. Check wiring against the diagram</li> <li>2. Determine reason and correct</li> <li>3. Determine reason and replace</li> <li>4. Determine reason, correct or replace</li> </ol>
Compressor starts and runs, but short cycles on overload protector	<ol style="list-style-type: none"> <li>1. Low voltage to unit</li> <li>2. Overload defective</li> <li>3. Excessive head pressure</li> </ol>	<ol style="list-style-type: none"> <li>1. Determine reason and correct</li> <li>2. Check current, replace overload protector</li> <li>3. Check ventilation or restriction in refrigeration system</li> </ol>
Compressor operates long or continuously	<ol style="list-style-type: none"> <li>1. Short of refrigerant</li> <li>2. Control solenoid stuck</li> <li>3. Evaporator coil iced</li> <li>4. Restriction in refrigeration system</li> <li>5. Dirty condenser</li> </ol>	<ol style="list-style-type: none"> <li>1. Fix leak, add refrigerant</li> <li>2. Repair or replace</li> <li>3. Determine cause, defrost manually</li> <li>4. Determine location and remove restriction</li> <li>5. Clean condenser</li> </ol>
Compressor runs fine, but short cycles	<ol style="list-style-type: none"> <li>1. Overload protector</li> <li>2. Cold control</li> <li>3. Overcharge</li> <li>4. Air in system</li> <li>5. Undercharge</li> </ol>	<ol style="list-style-type: none"> <li>1. Check wiring diagram</li> <li>2. Differential too close - widen</li> <li>3. Reclaim and recharge</li> <li>4. Reclaim and recharge</li> <li>5. Fix leak, add refrigerant</li> </ol>
Inverter malfunction	<ol style="list-style-type: none"> <li>1. No Power</li> <li>2. Frequency input error</li> <li>3. Improper compressor wiring</li> </ol>	<ol style="list-style-type: none"> <li>1. Check power / ground wiring</li> <li>2. Check frequency at CCA</li> <li>3. Check compressor cable connections</li> </ol>
Refrigerated space too warm	<ol style="list-style-type: none"> <li>1. Control setting too high</li> <li>2. Refrigerant overcharge</li> <li>3. Dirty condenser</li> <li>4. Evaporator coil iced</li> <li>5. Not operating</li> <li>6. Air flow to condenser or evaporator blocked</li> </ol>	<ol style="list-style-type: none"> <li>1. Reset control</li> <li>2. Reclaim and recharge</li> <li>3. Clean condenser</li> <li>4. Determine reason and defrost</li> <li>5. Determine reason, replace if necessary</li> <li>6. Remove obstruction for free air flow</li> </ol>
Standard temperature system freezes the product	<ol style="list-style-type: none"> <li>1. Control setting is too low</li> <li>2. Control points stuck</li> </ol>	<ol style="list-style-type: none"> <li>1. Reset the control</li> <li>2. Replace the control</li> </ol>
Objectionable noise	<ol style="list-style-type: none"> <li>1. Fan blade hitting fan shroud</li> <li>2. Tubing rattle</li> <li>3. Vibrating fan blade</li> <li>4. Condenser fan motor rattles</li> <li>5. Worn fan motor bearings</li> </ol>	<ol style="list-style-type: none"> <li>1. Reform or cut away small section of shroud</li> <li>2. Locate and reform</li> <li>3. Replace fan blade</li> <li>4. Check motor bracket mounting, tighten</li> <li>5. Replace fan motor</li> </ol>
Failure to Heat	<ol style="list-style-type: none"> <li>1. Hi-limit switch tripped</li> <li>2. Incorrect setting</li> <li>3. Alarm enabled</li> </ol>	<ol style="list-style-type: none"> <li>1. Reduce temperature to reset hi-limit switch</li> <li>2. See control manual</li> <li>3. See control manual</li> </ol>
Humidity level not correct	<ol style="list-style-type: none"> <li>1. Water supply interrupted</li> <li>2. Incorrect control settings</li> <li>3. Piping not connected / sealed</li> <li>4. No power to humidifier</li> <li>5. Humidity range too high or low</li> </ol>	<ol style="list-style-type: none"> <li>1a. Check water supply</li> <li>1b. Clean Humidifier</li> <li>2. See control manual</li> <li>3a. Connect tubing</li> <li>3b. Seal joints</li> <li>4. Check power connections for humidifier</li> <li>5a. Modify humidity ON/OFF parameters</li> <li>5b. Modify dehumidification ON/OFF parameters</li> </ol>

# Stability Chamber Refrigeration Diagram (R600a)

## PIPING DIAGRAM

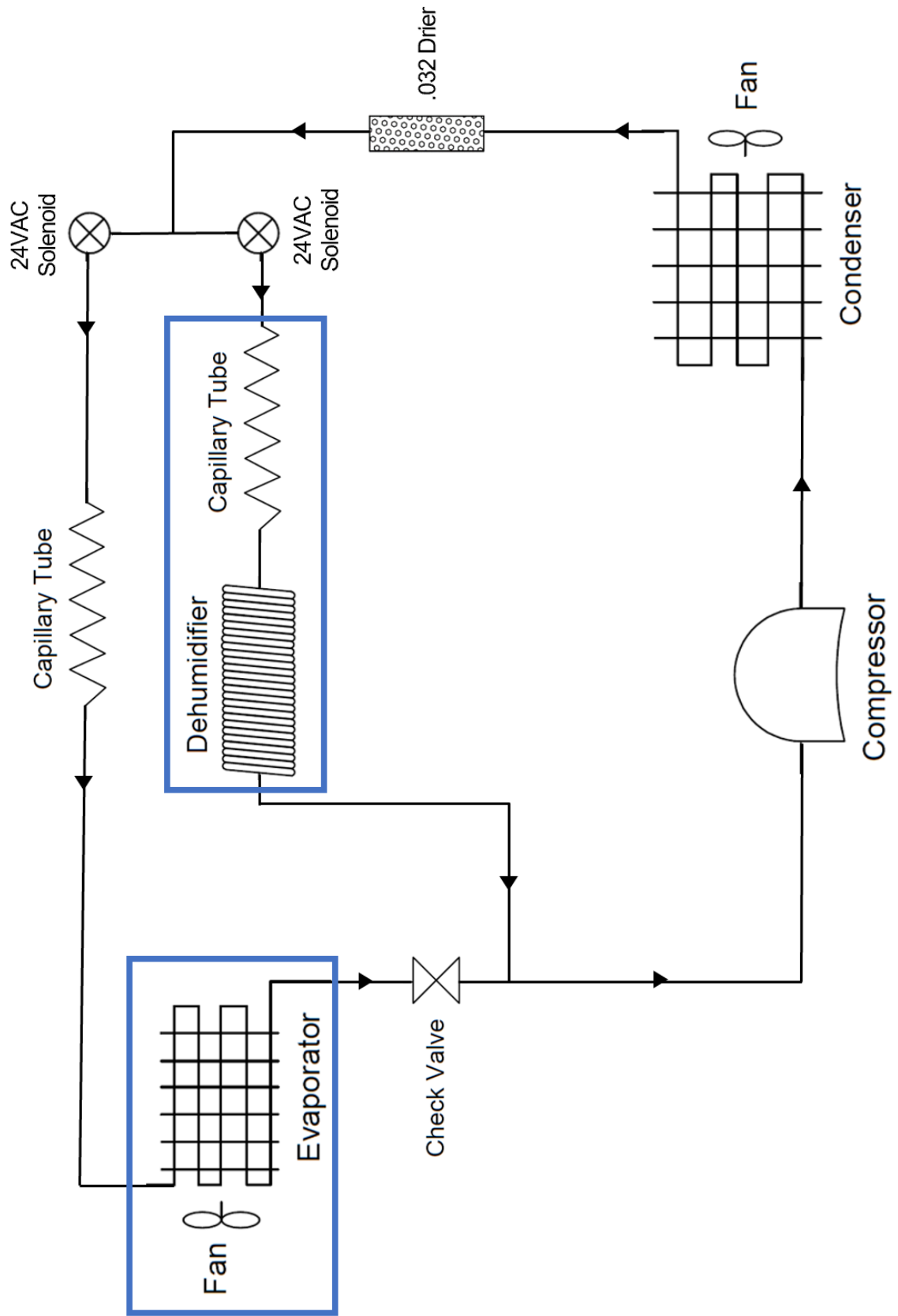

## FACTORY WARRANTY

Horizon Scientific, Inc. warrants to the original purchaser every new Horizon Scientific, Inc. refrigerated unit, the cabinet and all parts thereof, to be free from defects in material or workmanship, when such unit is installed, used, and maintained in accordance with provided instructions. The warranty period starts two weeks from the date of shipment from Horizon Scientific, Inc. This two-week period allows ample shipping time so that the warranty will go into effect at approximately the same time your equipment is delivered. Unless subject to prior written agreement with Horizon Scientific, Inc., this warranty does not allow for any warranty start deferment greater than two weeks from date of shipment due to a delayed installation and/or start-up. By purchasing any product from Horizon Scientific, Inc., you and any entity for which you are purchasing acknowledge and agree to every provision contained herein, and all other Notices and Terms provided to Purchaser by Horizon Scientific, Inc., which are hereby incorporated.

### FACTORY WARRANTY POLICY

Under this warranty, Horizon Scientific, Inc., through its authorized service organizations, will repair, or at its option, replace any part found to contain a manufacturing defect in material or workmanship without charge to the owner for parts and service labor. Replacement or repaired parts will be warranted for only the unexpired portion of the original warranty. Horizon Scientific, Inc. will not assume any shipping or cartage costs for parts under warranty. These costs shall be paid by the customer.

### ADDITIONAL COMPRESSOR WARRANTY

In addition to the standard warranty, Horizon Scientific, Inc. warrants its hermetically and semi-hermetically sealed compressors to be free from defects in both material and workmanship under normal use and service in addition to the standard warranty period. Compressors determined by Horizon Scientific, Inc. to have been defective within this extended time period will, at Horizon Scientific, Inc.'s option, be either repaired or replaced with a compressor or compressor parts of similar design and capacity.

The compressor warranty applies only to hermetically and semi-hermetically sealed parts of the compressor and does not apply to any other parts or components, including, but not limited to, cabinet, paint finish, temperature control, refrigerant, metering device, driers, motor starting equipment, fan assembly or any other electrical components.

Horizon Scientific, Inc.'s sole obligation under this warranty is limited to either repair or replacement of parts, subject to the additional limitations below.

This warranty neither assumes nor authorizes any person to assume obligations other than expressly covered by this warranty.

**NO CONSEQUENTIAL DAMAGES.** Horizon Scientific, Inc. is not responsible for economic loss; profit loss; or special, indirect or consequential damages, including without limitation, losses or damages arising from contents spoilage claims whether because of refrigeration failure, electrical failure, power failure, or compressor failure. HORIZON SCIENTIFIC, INC.'S MAXIMUM CUMULATIVE LIABILITY RELATIVE TO ALL CLAIMS AND LIABILITIES, INCLUDING OBLIGATIONS UNDER ANY INDEMNITY, WHETHER OR NOT INSURED, SHALL NOT EXCEED THE COST OF THE PRODUCT(S) GIVING RISE TO THE CLAIM OR LIABILITY.

**WARRANTY IS NOT TRANSFERABLE.** This warranty is not assignable and applies only

in favor of the original purchaser/user to whom delivered. Any such assignment or transfer shall void the warranties herein made and shall void all warranties, express or implied, including any warranty of merchantability of fitness for a purpose.

**NO IMPLIED WARRANTY OF MERCHANTABILITY OF FITNESS FOR A PARTICULAR PURPOSE.** There are no other warranties, express, implied, or statutory, except the standard warranty and the additional compressor warranty as described above. These warranties are exclusive and in lieu of all other warranties, including implied warranty and merchantability of fitness for a purpose. There are no warranties which extend beyond the description on the face hereof, whether based on contract, warranty, tort (including negligence), strict liability, indemnity, or any other legal theory, and whether arising out of warranties, representations, instructions, installations, or non-conformities from any cause. Purchaser further acknowledges that the purchase price of the Product reflects these warranty terms and remedies.

**ALTERATION, NEGLIGENCE, ABUSE, MISUSE, ACCIDENT, DAMAGE DURING TRANSIT OR INSTALLATION, FIRE, FLOOD OR OTHER EXTERNAL CAUSES.**

Horizon Scientific, Inc. is not responsible for the repair or replacement of any parts that Horizon Scientific, Inc. determines have been subjected after the date of manufacture to alteration, neglect, abuse, misuse, accident, damage during transit or installation, fire, flood or other external causes. It does not apply to defects resulting from failure to properly install, operate or maintain the product in accordance with the printed instructions provided, or damage caused by the storage of any corrosive material that comes in contact with the interior or exterior portions of the cabinet, or the use of spark producing equipment or containers (such as galvanized or carbonized steel containers) that come in contact with any interior portion of the cabinet.

**OUTSIDE U.S./CANADA.** This warranty does not apply to, and Horizon Scientific, Inc. is not responsible for, any warranty claims made on products sold or used outside the United States and Canada.

**CHOICE OF LAW/VENUE.** The laws of the State of South Carolina shall govern the validity, interpretation and enforcement of this warranty, regardless of conflicts of law principles. Purchaser agrees that proper venue for any action to enforce the terms of this warranty shall be the Dorchester County District Courts, South Carolina.

Purchaser submits the jurisdiction of such courts over the Purchaser and the subject matter of any such action. Any action for breach of these warranty provisions must be commenced within one (1) year after that cause of action has accrued.

**WARRANTY CLAIMS.** To obtain prompt warranty service, simply contact the manufacturer at 800-648-4041. Horizon Scientific, Inc.'s shipping records showing date of shipment shall be conclusive in establishing the warranty period. All claims should include model number of the refrigerator, the serial number of the cabinet, proof of purchase, date of installation, and all pertinent information supporting the existence of the alleged defect. Any repairs must be authorized by Horizon for the warranty to be honored.