

PHCbi

Operating Instructions

Ultra-Low Temperature Freezer

MDF-DU702VXC

MDF-DU502VXC



MDF-DU702VXC

Please read the operating instructions carefully before using this product, and keep the operating instructions for future use.

See page 58 for all model numbers.

CONTENTS

INTRODUCTION	3
PRECAUTIONS FOR SAFE OPERATION	4
LABELS ON UNIT	9
SYMBOLS ON UNIT	9
ENVIRONMENTAL CONDITIONS	10
FREEZER COMPONENTS	
Main body	11
LCD touch panel	13
Remote alarm terminal	15
Air intake port (Manual)	15
INSTALLATION SITE	16
INSTALLATION	17
START-UP PROCEDURE	19
DURING/AFTER POWER FAILURE	
Operation during power failure	20
Operation after recovery from power failure	20
BASIC OPERATION ON LCD TOUCH PANEL	21
BASIC PARAMETERS	
How to input numerical value and alphanumeric character	22
Setting Temperature, High Alarm and Low Alarm	24
Setting operation control mode	25
Setting key lock	26
Removing key lock	29
ALARM PARAMETERS	30
OPERATION/ALARM LOG	
Setting log interval	32
Displaying operation log	33
Exporting operation log	36
Displaying alarm log	39
Exporting alarm log	41
OTHER PARAMETERS	
Setting date and time	44
Setting brightness and sleep	45
ALARMS AND SELF-DIAGNOSIS	47
ROUTINE MAINTENANCE	
Cleaning the exterior, interior, and accessories	50
Cleaning of air intake port (Manual)	50
Defrosting of chamber	51
CALIBRATION	51
REPLACEMENT OF WORN-OUT PARTS	
Replacing the battery for power failure alarm	52
Replacing the battery for backup cooling kit	52
TROUBLESHOOTING	53
DISPOSAL OF UNIT	54
Recycle of battery	54
OPTIONAL COMPONENTS	
Temperature recorder	55
Small inner doors	55
Inventory rack	55
Back-up cooling kit	56
SPECIFICATIONS	57
PERFORMANCE	58
SAFETY CHECK SHEET	59

INTRODUCTION

- Read the operating instructions carefully before using the product and follow the instructions for safe operation.
- PHC Corporation takes no responsibility for safety if the product is not used as intended or is used with any procedures other than those given in the operating instructions.
- Keep the operating instructions in a suitable place so that they can be referred to as necessary.
- The operating instructions are subject to change without notice for improvement of performance or function.
- Contact our sales representative or agent if any page of the operating instructions is lost or the page order is incorrect, or if the instructions are unclear or inaccurate.
- No part of the operating instructions may be reproduced in any form without the express written permission of PHC Corporation.

IMPORTANT NOTICE

PHC Corporation guarantees this product under certain warranty conditions. However, please note that PHC Corporation shall not be responsible for any loss or damage to the contents of the product.

<Intended Use>

This equipment is designed for low temperature storage of biomedical samples.

PRECAUTIONS FOR SAFE OPERATION

It is imperative that the user complies with the operating instructions as they contain important safety advice.

Items and procedures are described so that you can use this unit correctly and safely. Following these precautions will prevent possible injury to the user and any other person.

Precautions are illustrated in the following way:

WARNING

Warning indicates a potentially hazardous situation which, if not avoided, could result in serious injury or death.

CAUTION

Failure to observe CAUTION signs could result in injury to personnel and damage to the unit and associated property.

Symbols have the following meanings:

 This symbol means caution.

 This symbol means an action is prohibited.

 This symbol means an instruction must be followed.



Be sure to keep the operating instructions in a place that is accessible to users of this unit.









For the State of California, USA Only:

This product contains a CR Coin Cell Lithium Battery which contains Perchlorate Material – special handling may apply. See www.dtsc.ca.gov/hazardouswaste/perchlorate.

PRECAUTIONS FOR SAFE OPERATION













WARNING

-  **Do not use the unit outdoors.** Exposure to rain may cause leakage and/or electric shock.
-  **Only qualified engineers or service personnel should install the unit.** Installation by unqualified personnel may cause electric shock or fire.

Install the unit in a location capable of bearing the total combined weight (product + optional accessories + stored items). **After installing the unit, be absolutely sure to take precautions to prevent the unit from falling over.** If the unit is installed in a location which is not strong enough or if the proper precautions are not taken, the unit may fall over and cause injuries.
-  **Do not install the unit where there are high levels of moisture or where it may be splashed with water.** Installing the unit where there are high levels of moisture or where it may be splashed with water may cause the insulation to deteriorate and give rise to leakage and/or electric shock.
-  **Do not install the unit in a location where flammable or volatile substances are present.** Installing the unit in a location where flammable or volatile substances are present may cause explosions and/or a fire.
-  **Do not install the unit in a location where corrosive gases such as acids are present.** Installing the unit in a location where corrosive substances are present may cause electrical components to corrode, leading to leakage and/or electric shock due to the deterioration of insulation resulting from corroded electrical components.
-  **Do not place this unit in a location where it is difficult to disconnect the power supply plug.** Failure to disconnect the power supply plug may cause fire in the event of a problem or malfunction.
-  **Be absolutely sure to earth (ground) the unit to prevent electric shock.** Failure to earth the product may give rise to electric shock. If necessary, ask a qualified contractor to do this work.
-  **Do not connect the earth wire to a gas pipe, water pipe or lightning rod when earthing the unit.** Earthing the unit improperly may give rise to electric shock.
-  **Connect the unit to a power source as indicated on the rating label attached to the unit.** Use of any other voltage or frequency other than that on the rating label may cause fire or electric shock.
-  **Never store volatile or flammable substances in this unit except in a sealed container.** Such substances may cause explosion or fire if they leak.
-  **Never insert metal objects such as pins and wires into any vent, gap, or outlet on the unit.** This may cause electric shock or injury by accidental contact with moving parts.

PRECAUTIONS FOR SAFE OPERATION

WARNING

-  **When handling harmful samples (for example, those which consist of toxic, pathogenic or radioactive substances), install the unit inside a designated isolation facility.** If the unit is installed in a location which is not an isolation facility, there may be detrimental effects on both people and the natural environment.
-  **Before proceeding with maintenance or checking the unit, set the power switch to OFF, and disconnect the power supply plug.** Performing the work while power is still flowing to the product or while the power supply plug is still connected may give rise to electric shock and/or injury.
-  **Do not touch any electrical parts (such as power supply plug) or operate switches with a wet hand.** This may cause electric shock.
-  **Wear protective gloves and mask during maintenance.** Touching or inhaling chemicals or aerosols from around the unit may be detrimental to health.
-  **Never splash water directly onto the unit** as this may cause electric shock or short circuit.
-  **Never put containers with liquid on top of the unit** as this may cause electric shock or short circuit if the liquid is spilled.
-  **Never damage the power supply cord or power supply plug (by breaking, adapting, placing near a source of heat, bending with force, twisting, pulling, adding weight, or binding).** A damaged power supply cord or power supply plug may cause electric shock, short circuit, or fire
-  **Never disassemble, repair, or modify the unit yourself.** A high-voltage area is located inside the unit. Any work carried out by unauthorized personnel may result in electric shock. Contact our sales representative or agent for maintenance or repair.
-  **Make sure the power supply plug is pushed fully in.** Faulty insertion of the power supply plug may cause electric shock or fire due to generation of heat. Never use a damaged power supply plug or loose power outlet
-  **Disconnect the power supply plug if there is anything wrong with the unit.** Continued abnormal operation may cause electric shock or fire.
-  **Grip the power supply plug when disconnecting the power supply cord from the outlet.** Pulling the power supply cord may cause electric shock or short circuit.
-  **Remove dust from the power supply plug periodically.** Dust on the power supply plug may cause insulation failure due to moisture and thus cause a fire. Disconnect the power supply plug and wipe it with a dry cloth

PRECAUTIONS FOR SAFE OPERATION

WARNING

 **Disconnect the power supply plug before moving the unit.** Take care not to damage the power supply cord. A damaged power supply cord may cause electric shock or fire.

 **Disconnect the power supply cord when the unit is not in use for long periods.** Keeping the unit connected may cause electric shock, leakage, or fire due to the deterioration of insulation.

 If the unit is to be stored unused in an unsupervised area for a long period, **ensure that children do not have access and that doors cannot be closed completely.**

 **Ask a qualified contractor to carry out disassembly and disposal of the unit.** Leaving the unit in a location that can be accessed by third parties may result in unexpected accidents (e.g. the unit may be used for unintended purposes).

 **Do not leave the plastic bags used for packing in a place where they can be reached by small children** as this may result in unexpected accidents such as suffocation.

 **Never replace the battery for the power-failure alarm yourself.** Only qualified engineers or service personnel should replace the battery.

 **When moving the unit, be sure to take precautions to prevent it from falling over.** Moving the unit with too much force may cause it to fall over, possibly resulting in injury. A qualified individual must be assigned to supervise the safe movement and relocation of the unit.

 **Install the unit in a well-ventilated (airy) location to prevent the accumulation of flammable refrigerant.** The flammable refrigerant may cause fire if it leaks.

 **Never damage the chamber wall or pipework in the chamber when removing frost.** The refrigerant is flammable and may cause a fire if it leaks.







 **Flammable and explosive product.** The unit contains flammable refrigerant. Be sure to follow the below instructions when servicing or recycling.

- Well ventilate the room to prevent refrigerant accumulation.
- Keep fire away when the refrigerant is contained in the product.
- Do not damage or break the pipework.

 As with any equipment that uses CO₂ gas, there is a likelihood of oxygen depletion in the vicinity of the equipment. It is important that you assess the work site to ensure there is suitable and sufficient ventilation. If lack of ventilation is suspected, then other methods of ensuring a safe environment must be considered. These may include atmosphere monitoring systems and warning devices with alarms.

PRECAUTIONS FOR SAFE OPERATION





CAUTION

-  **Never install the unit in a location where corrosive materials such as sulphur compounds are likely to be generated (e.g. near a drainage facility).** Corrosion of the copper pipes may result in the deterioration and consequently the failure of the cooling unit.
-  **This unit must be plugged into a dedicated circuit protected by branch circuit breaker.**
-  **Use a dedicated power source as indicated on the rating label attached to the unit.** A multiple-tap may cause fire resulting from abnormal heating.
-  **Do not climb on top of the unit or put any objects on the unit.** Falling from the unit may cause injury; falling objects may cause damage to the unit.
-  **Never store corrosive substances such as acids or alkalis in this unit except in a sealed container.** These may be harmful to your health and may cause corrosion of internal components or electrical parts.
-  **Check the settings when restarting operation after a power failure or after turning the power off.** The settings may have changed as a result of stopping the unit. Stored items inside the unit may be adversely affected when operation is resumed if the settings have changed.
-  **To ensure the safety of the service engineer, submit a safety check sheet with the required items filled out.** This is provided as the photocopyable “Safety Check Sheet” at the end of these operating instructions

LABELS ON UNIT

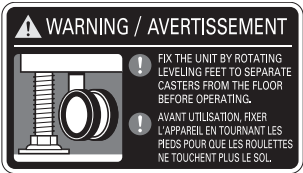

<Labels applied to the unit>

To avoid accidents, users are advised to read carefully the hazard labels found at key locations on the interior and exterior of the unit.

Possible Danger	Warning/Caution Type Location of Danger	Warning/Caution Label	Description of Danger
Personal injury Sample damage	Frostbite Rise in chamber temperature Interior		To prevent frostbite, wear protective gloves when handling frozen items in the chamber. Too much frost may cause chamber temperature rise resulting from incomplete door close.
Sample damage	Chamber temperature Interior		Always use the outer door latch when closing the outer door. Improper closure may cause the temperature to rise in the chamber.
Personal injury	Bruise or fracture Exterior		When the casters are raised from the surface of the floor, the unit is secured. If they are left touching the floor, the unit may inadvertently move out of position when its door is opened or closed. It may cause injury.
Damage of outer door latch	Negative pressure release Interior		Ice should be removed from the air intake port using the designated frost removal stick.
Personal injury	Flammable and explosive product Exterior, Interior		This product contains flammable refrigerant. Be sure to follow the instructions on the warning label when servicing or recycling.

SYMBOLS ON UNIT

The following symbols are attached to the unit. The table describes the meaning of the symbols.

	This symbol is attached to covers that access high-voltage electrical components to prevent electric shock. Only a qualified engineer or service personnel should be allowed to open these covers.
	This symbol indicates that caution is required. Refer to product documentation for details.
	This symbol indicates an earth.
	This symbol means "ON" for a power switch.
○	This symbol means "OFF" for a power switch.

ENVIRONMENTAL CONDITIONS

This equipment is designed to be safe at least under the following conditions (based on the IEC 61010-1):

- Indoor use;
- Altitude up to 2000 m;
- Temperature 5 °C to 40 °C;
- Maximum relative humidity 80 % for temperature up to 31 °C decreasing linearly to 50 % relative humidity at 40 °C;
- Mains supply voltage fluctuations up to ± 10 % of the nominal voltage;
- Transient overvoltages up to the levels of OVERVOLTAGE CATEGORY II;
- Temporary OVERVOLTAGES occurring on the mains supply;
- Applicable pollution degree of the intended environment (POLLUTION DEGREE 2 in most cases);

FREEZER COMPONENTS

Main body

The model below is the MDF-DU702VXC. However, the MDF-DU502VXC is also equivalent structures.

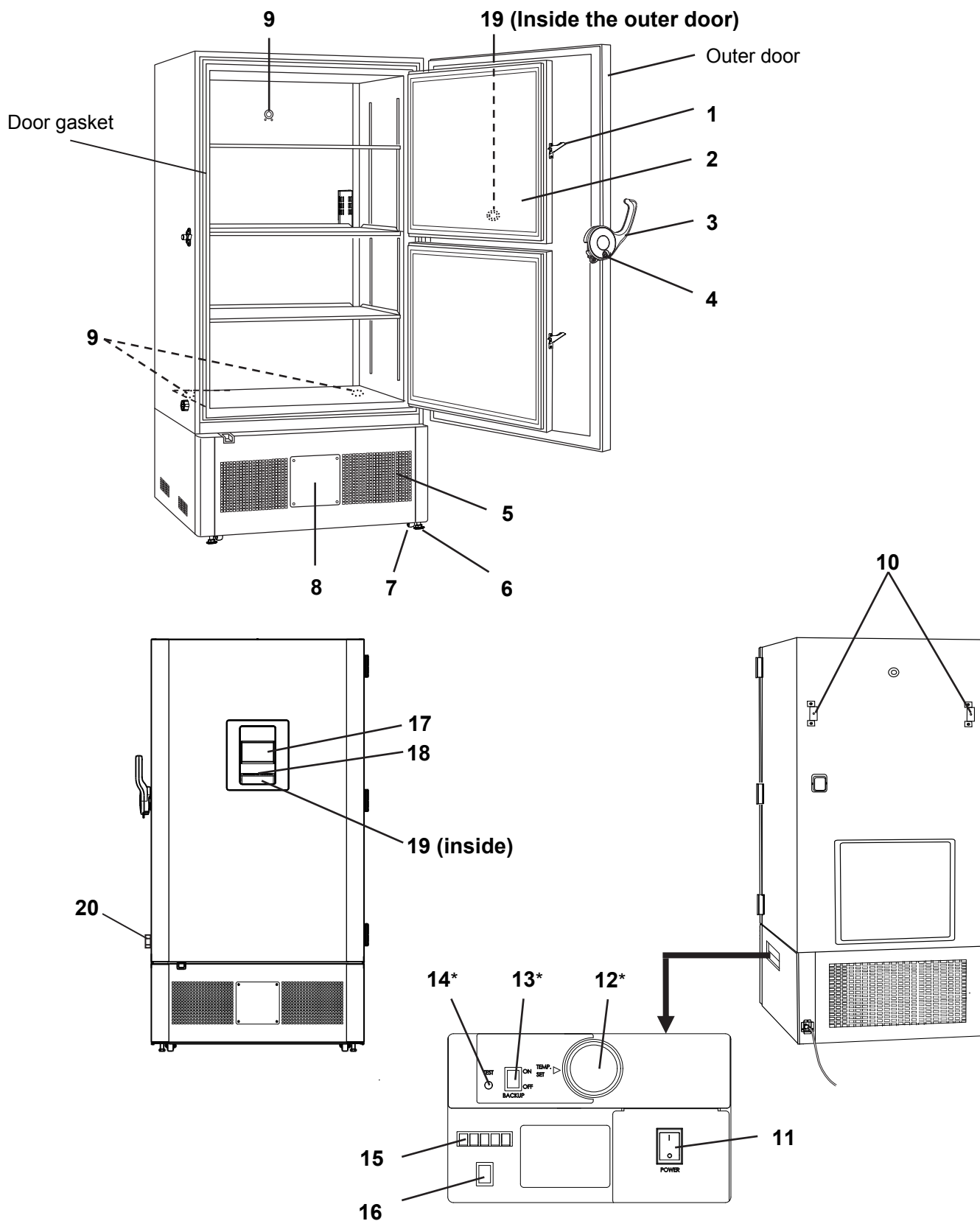

* When an optional backup cooling kit is installed.

FREEZER COMPONENTS

- 1. Inner door latch:** Always lock the inner door latch when the inner door is closed.
- 2. Inner door:** This prevents cold air from escaping when the outer door is opened. Always be sure to close the inner door securely before closing the outer door. The inner door can be removed for cleaning or defrosting [page 51].
- 3. Outer door latch:** When closing the outer door push the latch until the latch is locked in place. Provision has been made for use of an additional padlock (not included).
- 4. Keyhole:** Turn clockwise to 180° with a key and the outer door is securely locked.
- 5. Air intake vent (grille):** Do not block this vent to keep the proper cooling performance.
- 6. Leveling feet:** These are screw bolts used to install and fix the unit. Adjust the height of the leveling feet by turning the screw bolts until 2 front casters are away from the floor.
- 7. Caster:** 4 casters are provided to facilitate moving of the cabinet. For the installation, adjust the leveling feet so that the front 2 casters cannot contact with the floor.
- 8. Space for temperature recorder:** A temperature recorder (optional) can be mounted here so that the chamber temperature can be recorded automatically [page 55].
- 9. Access port (rear and bottom):** These ports are used to pass the sensor or cable of measuring equipment, the sensor of a temperature recorder (optional), or the nozzle of a back-up cooling kit (optional) to the chamber.
- 10. Fixture (on back side):** Use the fixtures and secure the unit to a wall with a strong rope or chain [page 17].
- 11. Power switch:** This is the power switch of the unit. (ON="I",OFF="O")
- 12. Temperature setting knob (TEMP. SET)*:** It is the knob which adjusts injection set temperature of the backup cooling kit [page 56].
- 13. Backup power switch (BACK UP)*:** Power switch of the backup cooling kit [page 56].
- 14. Backup test switch (TEST)*:** It is the switch to confirm that the backup cooling kit can inject liquid CO₂ [page 56].
- 15. Remote alarm terminal:** A remote alarm device (separately available) can be connected to this terminal. The remote alarm relays the alarm to an operator in a remote location if the unit is unattended [page 15].
- 16. Battery switch:** This is an ON-OFF switch for the battery for the power-failure alarm. Always turn this switch on when the unit is operating to ensure that the power-failure alarm is working. Turn this switch off when the unit is not used for a long period in order to protect the battery.
- 17. LCD touch panel:** See pages 13 - 14.
- 18. USB port:** Insert USB memory to export operations and alarms log [pages 36 - 43].
Note: It is impossible to use USB memory which is required password input.
- 19. Air intake port (Auto):** This operates automatically when the outer door is closed. The outer door can be opened easily because this port intakes the outer air and the pressure difference between the chamber and outside is deleted. During the operation of this port, the suction noise arises, but this is not a malfunction.
- 20. Air intake port (Manual):** Adjust the pressure difference inside and outside the chamber manually to open the outer door smoothly [page 15].

* When an optional backup cooling kit is installed.

FREEZER COMPONENTS

LCD touch panel

The following display (called the Top screen) will appear when the power switch is turned ON.

Note: It takes approximately 20 seconds until Top screen is displayed.

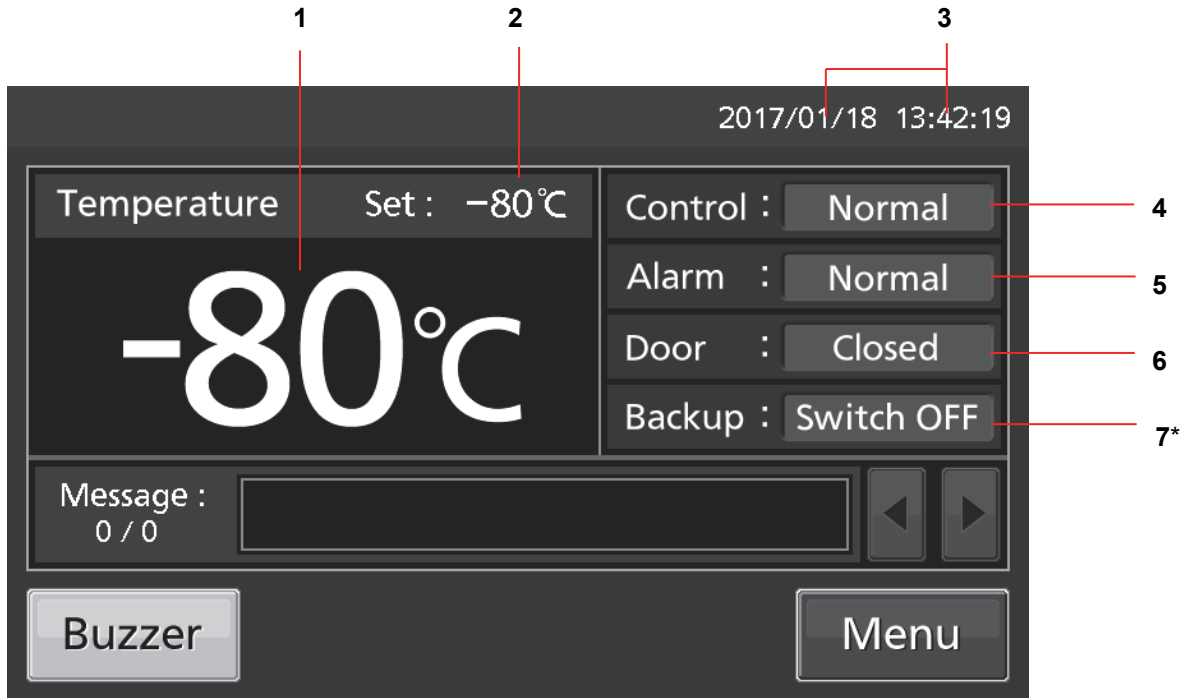

1. Present temperature display field: The current chamber temperature is displayed.

Note: An integer rounded off below a decimal point is displayed.

2. Set temperature value display field: The set value of chamber temperature is displayed. Default setting: -80 °C.

3. Present date/time display field: Normally, this indicator shows date and time. The date and time is simply set when the freezer is shipped from the factory [page 44].

4. Control display: The present operation control mode is displayed [pages 25 - 26 for setting].

Normal control: "Normal" is displayed.

Eco control: "ECO" is displayed.

5. Alarm display: Refer to pages 47 – 48.

Normal condition: "Normal" is displayed.

Alarm-activated, buzzer-delayed: "Alarm" is displayed alternately in normal characters and reverse video.

Alarm-activated, buzzer-sounding: "Warning" is displayed alternately in normal characters and reverse video.

6. Door (opening/closing) display:

Open: "Open" is displayed alternately in normal characters and reverse video.

Close: "Closed" is displayed.

7. Backup display*: (It is displayed only when an optional backup cooling kit is installed) ON/OFF of the backup power switch is displayed [page 56].

ON: "Switch ON" is displayed.

OFF: "Switch OFF" is displayed.

* When an optional backup cooling kit is installed.

FREEZER COMPONENTS

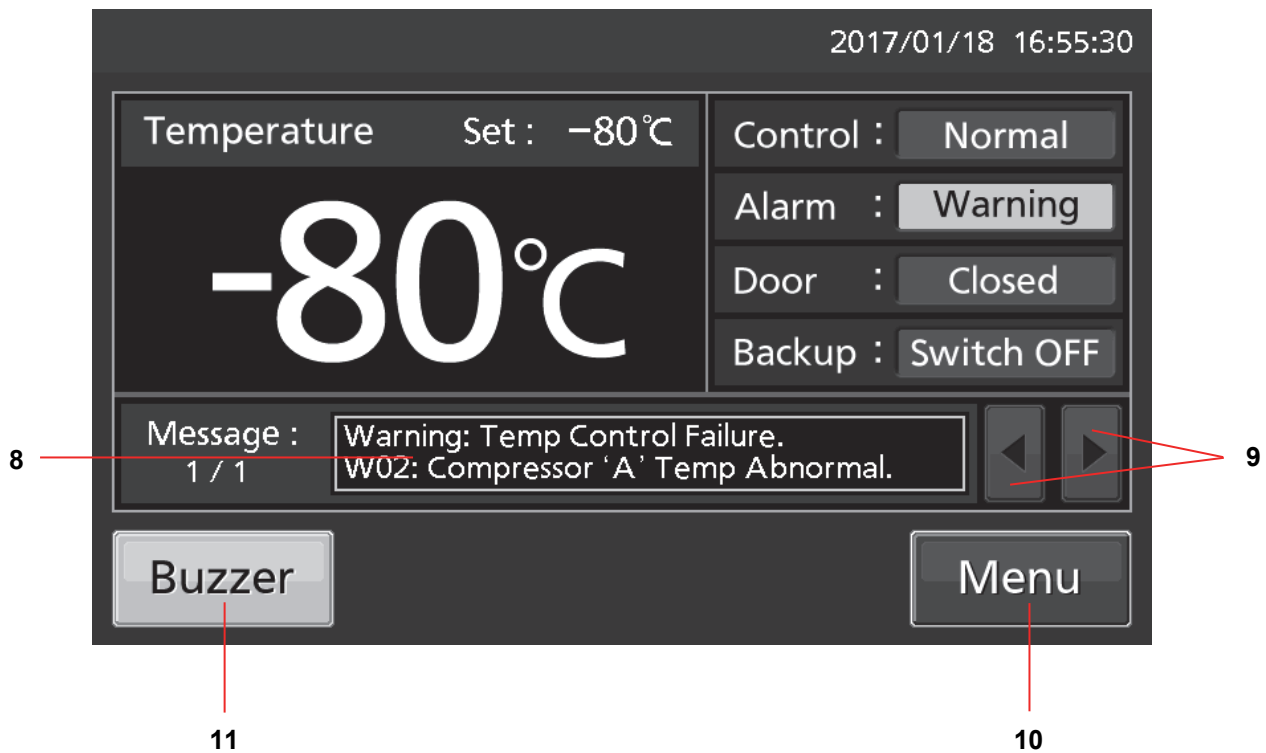

8. Message display field: The information of the operation monitor system, alarms or status are displayed when fault occurs [pages 47 - 48].

9. Message select key: When there are a number of alarm, status or information of the operation monitor system, the message on the screen is changeable.

10. Menu key: Press this key to lead the Menu screen. It is possible to set various setting on the Menu screen [page 21].

11. Buzzer key: Press this key to silence the buzzer. However, when the ring back is ON, the buzzer will sound again when the ring back passed and the alarm state still continues [pages 30 - 31 and 49].

FREEZER COMPONENTS

Remote alarm terminal

The alarm of this unit can be informed at a remote location from this unit by connecting the external alarm device to the remote alarm terminals. For the type and behavior of remote alarm output [pages 47 - 48].

The terminal of the remote alarm is installed at the right side of the unit (See the figure on the point). The alarm is outputted from this terminal. Contact capacity is DC 30 V, 2 A.

When Buzzer key is pressed, the behavior of the remote alarm is showed in Table.1.

Note:

- In the door alarm, the remote alarm does not work [page 48]
- It is recommended to use standard signal and interface cables with a maximum length of 30 meters.

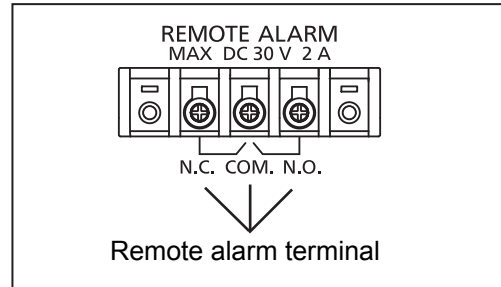

Table 1 The behavior of the remote alarm when pressing Buzzer key

Remote Alarm setting [pages 30 – 31]	Connecting terminal	Normal condition	Abnormal condition (Including in the cases of power outage and of where the power plug is pulled out.)	
			When pressing Buzzer key	
ON: Non-interlock with Buzzer key	COM.-N.C.	Close	Open	Open (Maintain in abnormality)
	COM.-N.O.	Open	Close	Close (Maintain in abnormality)
OFF: Interlock with Buzzer key	COM.-N.C.	Close	Open	Close (Return to normal)
	COM.-N.O.	Open	Close	Open (Return to normal)

Air intake port (Manual)

The difference in pressure inside and outside of the chamber is adjusted automatically to open the outer door smoothly.

However, if the door becomes heavy and difficult to open, follow the procedure below.

1. Turn the cap on the left side counterclockwise about two laps.
(Or remove the cap.)
2. Allow about twenty seconds before open the outer door.
3. Close (or replace) the cap when the door operation is completed.

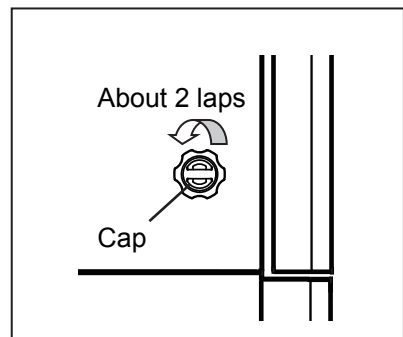

Remove the cap on the air intake port and check for the frost inside the air intake port.

If excessive frost has built up in the air intake port, remove with a "Stick for air intake port cleaning" [page 50].

⚠ CAUTION

For removing the frost in the air intake port, do not use a tool with sharp edge such as a knife or a screw driver.

INSTALLATION SITE

This unit must be installed in a location which meets all the conditions described below.

✧ If the unit is installed in a location which does not meet the conditions, its specified performance may not be achieved or malfunctions and accidents may occur.

■ A location not exposed to direct sunlight

Avoid any location which is exposed to direct sunlight. Installing the unit in a location exposed to direct sunlight may reduce its cooling performance.

■ A well-ventilated (airy) location

In order to ensure ventilation, leave clearances of at least 10 cm around the unit (at the left, right, top and back). Blocking the ventilation may reduce the unit's cooling performance or cause malfunctions.

■ A location away from sources of heat

Avoid any location which is close to a major source of heat (such as a heater or boiler). Installing the unit near a major source of heat may reduce the unit's cooling performance.

■ A location with minimal changes in temperature

Avoid any location where the ambient temperature is subject to sudden changes. If the unit is installed in a location where the ambient temperature is subject to sudden changes, it will not be possible to achieve a stable cooling performance.

■ A flat surface where the floor is also capable of bearing the total combined weight (product + optional accessories + stored items)

Install the unit on a flat surface which is even and which is capable of bearing the total combined weight (product + optional accessories + stored items). If the unit is installed where the surface is uneven or where the unit will be inclined at an angle, the unit will be unstable, and accidents or injuries may occur and/or unnecessary vibration or noise may be generated.

■ A location with minimal humidity

Install the unit in a location where the relative humidity is less than 80 %R.H. Installing the unit in a very humid location may cause earth faults and/or electric shock.

■ A location free of flammable or corrosive gases

Avoid any location exposed to flammable or corrosive gases. Flammable or corrosive gases can cause explosions and/or a fire. Furthermore, corrosion of the electrical parts may cause the insulation to be reduced and result in earth faults and/or electric shock.

■ A location where nothing can fall onto the unit

Avoid locations where objects may fall onto the unit. Objects falling and hitting the unit may cause it to break down or fail.

INSTALLATION

When installing the unit, follow the steps below to secure the unit properly, and also be absolutely sure to earth the unit.

✧In addition, install an earth leakage circuit breaker (on the unit's power supply side), which is mandatory under the applicable laws and regulations.

1. Preparations after unpacking

Remove all the tape used to secure the doors and interior parts, and leave the doors open for a short while for ventilation.

If any surfaces of the outer cabinet are dirty, wipe the surface using a cloth moistened with a diluted neutral dish-washing detergent.

✧Using an undiluted solution of detergent may cause the unit's plastic areas to crack. Follow the directions on the detergent for details of dilution.

✧After wiping the unit using the diluted detergent, be absolutely sure to wipe the surfaces with a cloth dipped in clean water to remove traces of the detergent. After this, be absolutely sure to wipe the surfaces with a dry cloth, allowing the surfaces of the outer cabinet to dry out completely, and then proceed with the installation.

Note:

Remove the cable tie that bands the power supply cord. Prolonged contact with the tie may cause corrosion of the cord coating.

2. Securing and levelling the unit using the levelling feet

Rotate the front levelling feet clockwise until the casters are raised 5 mm to 10 mm above the floor surface. (Fig. 1) In addition, rotate the levelling feet slightly clockwise or anticlockwise, and adjust them so that the unit is completely level.

✧When the casters are raised from the floor surface, the unit will be secured. If they are left touching the floor, the unit may accidentally move when its door is opened or closed.

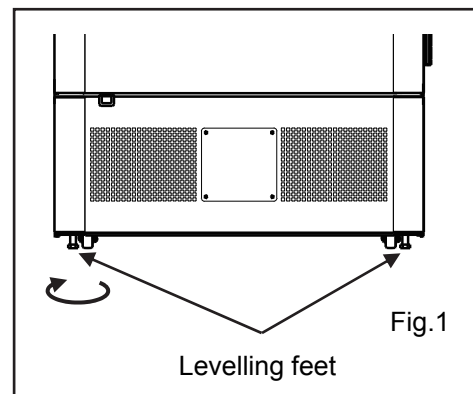

3. Securing the unit by using the fixtures

Use the fixtures on the rear panel of the unit, and secure the unit to a wall with a strong rope or chain. (Fig. 2)

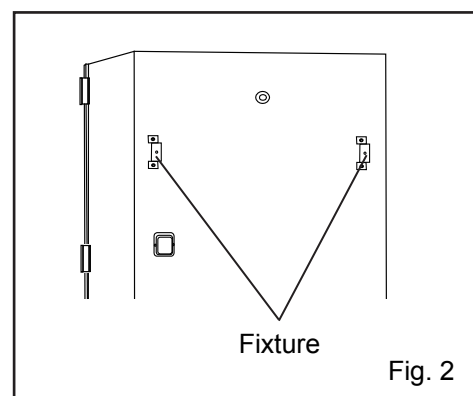

INSTALLATION

4. Preventing electric shock by earthing the unit

When installing the unit, be absolutely sure to earth (ground) it. Earthing is necessary to prevent electric shock resulting from deterioration of electrical insulations

✧ This unit comes with a 3-pin plug having one earth pin. Earthing work is not required in the case of a 3-pin power outlet equipped with an earth contact.

✧ If the power outlet is not a 3-pin outlet equipped with an earth contact, ask a qualified contractor to do the earthing work.

5. Setting up the shelves

Three shelves are packaged at the bottom of the chamber. Set the shelves firmly in place on the shelf stoppers at the standard locations. (Fig. 3)

6. Installing an earth leakage circuit breaker

Install an earth leakage circuit breaker (on the unit's power supply side), which is mandatory under the applicable laws and regulations.

✧ Contact our sales representative or agent to arrange the installation of an earth leakage circuit breaker.

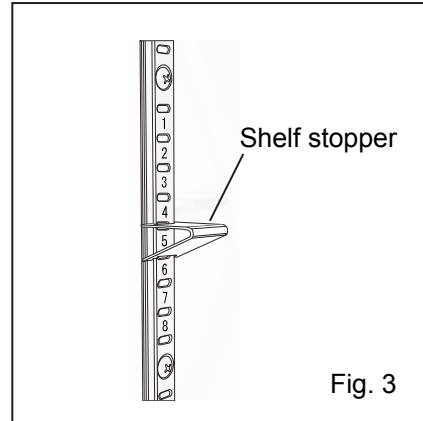

START-UP PROCEDURE

Follow this procedure for the initial operation of the unit and for consequent operations (after temporary stoppage for cleaning, maintenance or moving).

✧After a power failure, the unit will restart operation automatically with the same settings as before the power failure. [page 20],

1. Check that the following switches are turned off: [power switch, battery switch, switch of the optional back-up cooling kit (if installed)].

2. Connect the power supply cord to the dedicated power source with the appropriate rating with the chamber empty.

3. Turn ON the power switch to start operation of the unit.

4. Turn on the battery switch.

Note: When the battery switch for power failure alarm is OFF, "S20: Battery Inactive, SW may be OFF." is displayed in the message display field. By turning ON the battery switch for power failure alarm, this message disappears.

5. Set the desired chamber temperature [page 24].

✧The factory setting of chamber temperature is -80 °C.

6. Using the temperature display, check that the chamber temperature has cooled to the set temperature.

✧Check that the chamber temperature falls to the set temperature when the start-up after cleaning, maintenance or moving.

7. Turn on the switch of the optional back-up cooling kit (if installed).

8. Do the alarm test. Make sure that the buzzer sounds by pressing Buzzer key for 5 seconds. Press Buzzer key again to stop the buzzer and the alarm test finishes.

9. Press the test switch of the optional back-up cooling kit (if installed) to check it is working.

10. Gradually place the material inside the chamber.

✧Putting a large amount of material into the chamber at one time causes the temperature to rise.

11. Set the alarm temperature [pages 24 – 25] and the buzzer suspended period [pages 30 - 31], lock the menu setting [pages 26 - 28], and set the compressor delay [page 26], and door alarm delay [pages 30 - 31] as required.

Note:

- When closing the outer door push the latch until the latch is locked in place. Insufficient pushing can lead to temperature rise in the chamber.
- In case some optional inventory racks are in the chamber, be careful not to drop inventory rack when pulling out it.

DURING/AFTER POWER FAILURE

Operation during power failure

When the battery switch for power failure is ON, during a power failure the behavior of this unit is as follows.

- The power failure alarm is activated [page 47].

Press Buzzer key to silence the buzzer of the power failure alarm. In case the ring back is turned ON, buzzer sounds again when a power failure still continues after ring back set time passed [page 31].

- LCD touch panel is turn OFF [page 47].

By touching the LCD touch panel, it lights in the set brightness for 5 seconds.

- The High/Low Alarm is ready to activate during a power failure [pages 24 - 25 and 47].

An alarm message is displayed on the message display field. Alarm display, the buzzer and the remote alarm (although it is of the power failure alarm) are already activated.

- The clock function does not stop.

- Operation log data and alarm log data during a power failure is saved.

Note: When the capacity of the battery for power failure alarm is flat during a power failure, subsequent operation log data and alarm log data is not saved.

Operation after recovery from power failure

The set value is memorized by nonvolatile memory. Accordingly, the chamber resumes the operation with setting before power failure.

Note:

- It may take up to 1 minute until the LCD touch panel lights after recovery from power failure.
- All products start at the same time as the recovery from the power failure, so that, the temporary voltage drop may have a bad influence on the starting of this unit. To prevent this situation, set the appropriate compressor delay time of this unit [pages 25 - 26].

Although the power failure alarm is canceled at the recovery of the power failure, in order to remind that power failure had happened, buzzer is sounding and "Alarm" is displayed alternately in normal characters and reverse video in the alarm display [page 49]. By pressing Buzzer key, the alarm display returns to "Normal" and the buzzer stops.

Note: It is possible to confirm the past alarms in the "Displaying alarm log" [pages 39 - 40].

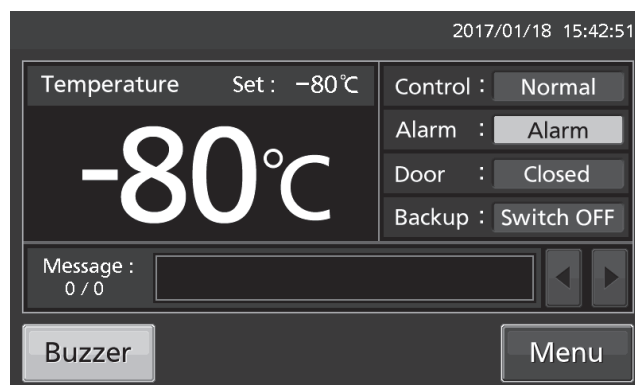

BASIC OPERATION ON LCD TOUCH PANEL

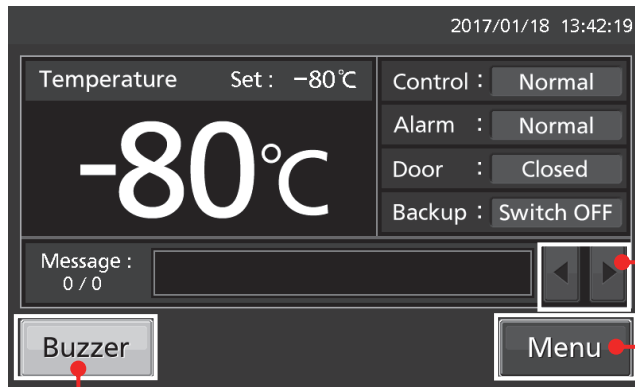

- ◆ Message select key: (Operate) Changing some messages
- ◆ Buzzer key: (Operate) Silencing the buzzer (Alarm is not canceled except for some alarms; page 49)

● Operation from Menu key

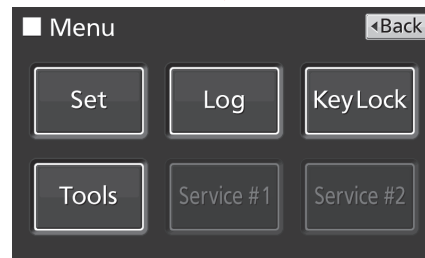

Menu screen		Page																																														
◆ Set	<table border="1"> <tr> <td>◆ Temp. Setting screen</td> <td>(Setting)</td> <td>Temp., High Alarm, Low Alarm</td> <td>24~25</td> </tr> </table>	◆ Temp. Setting screen	(Setting)	Temp., High Alarm, Low Alarm	24~25																																											
◆ Temp. Setting screen	(Setting)	Temp., High Alarm, Low Alarm	24~25																																													
◆ Log	<table border="1"> <tr> <td>◆ Log screen</td> <td></td> <td></td> <td></td> </tr> <tr> <td> ◆ Chart</td> <td> <table border="1"> <tr> <td>◆ Chart screen</td> <td></td> <td></td> <td></td> </tr> <tr> <td> ◆ Actual Temp.</td> <td>(Display)</td> <td>Chamber temp. log graph (can be exported)</td> <td>33~35</td> </tr> <tr> <td> ◆ Door Opening</td> <td>(Display)</td> <td>Door opening log graph (can be exported)</td> <td>33~35</td> </tr> </table> </td> <td></td> </tr> <tr> <td> ◆ Data Export</td> <td> <table border="1"> <tr> <td>◆ Export screen</td> <td></td> <td></td> <td></td> </tr> <tr> <td> ◆ Actual Temp.</td> <td>(Export)</td> <td>Chamber temperature log</td> <td>36~38</td> </tr> <tr> <td> ◆ Door Opening</td> <td>(Export)</td> <td>Door opening log</td> <td>36~38</td> </tr> <tr> <td> ◆ Setting</td> <td>(Setting)</td> <td>Log interval, Unique ID</td> <td>32~33</td> </tr> <tr> <td> ◆ Alarm</td> <td>(Display)</td> <td>Alarm log (can be exported)</td> <td>39~40</td> </tr> <tr> <td> ◆ Alarm Export</td> <td>(Export)</td> <td>Alarm log</td> <td>41~42</td> </tr> </table> </td> <td></td> </tr> </table>	◆ Log screen				◆ Chart	<table border="1"> <tr> <td>◆ Chart screen</td> <td></td> <td></td> <td></td> </tr> <tr> <td> ◆ Actual Temp.</td> <td>(Display)</td> <td>Chamber temp. log graph (can be exported)</td> <td>33~35</td> </tr> <tr> <td> ◆ Door Opening</td> <td>(Display)</td> <td>Door opening log graph (can be exported)</td> <td>33~35</td> </tr> </table>	◆ Chart screen				◆ Actual Temp.	(Display)	Chamber temp. log graph (can be exported)	33~35	◆ Door Opening	(Display)	Door opening log graph (can be exported)	33~35		◆ Data Export	<table border="1"> <tr> <td>◆ Export screen</td> <td></td> <td></td> <td></td> </tr> <tr> <td> ◆ Actual Temp.</td> <td>(Export)</td> <td>Chamber temperature log</td> <td>36~38</td> </tr> <tr> <td> ◆ Door Opening</td> <td>(Export)</td> <td>Door opening log</td> <td>36~38</td> </tr> <tr> <td> ◆ Setting</td> <td>(Setting)</td> <td>Log interval, Unique ID</td> <td>32~33</td> </tr> <tr> <td> ◆ Alarm</td> <td>(Display)</td> <td>Alarm log (can be exported)</td> <td>39~40</td> </tr> <tr> <td> ◆ Alarm Export</td> <td>(Export)</td> <td>Alarm log</td> <td>41~42</td> </tr> </table>	◆ Export screen				◆ Actual Temp.	(Export)	Chamber temperature log	36~38	◆ Door Opening	(Export)	Door opening log	36~38	◆ Setting	(Setting)	Log interval, Unique ID	32~33	◆ Alarm	(Display)	Alarm log (can be exported)	39~40	◆ Alarm Export	(Export)	Alarm log	41~42		
◆ Log screen																																																
◆ Chart	<table border="1"> <tr> <td>◆ Chart screen</td> <td></td> <td></td> <td></td> </tr> <tr> <td> ◆ Actual Temp.</td> <td>(Display)</td> <td>Chamber temp. log graph (can be exported)</td> <td>33~35</td> </tr> <tr> <td> ◆ Door Opening</td> <td>(Display)</td> <td>Door opening log graph (can be exported)</td> <td>33~35</td> </tr> </table>	◆ Chart screen				◆ Actual Temp.	(Display)	Chamber temp. log graph (can be exported)	33~35	◆ Door Opening	(Display)	Door opening log graph (can be exported)	33~35																																			
◆ Chart screen																																																
◆ Actual Temp.	(Display)	Chamber temp. log graph (can be exported)	33~35																																													
◆ Door Opening	(Display)	Door opening log graph (can be exported)	33~35																																													
◆ Data Export	<table border="1"> <tr> <td>◆ Export screen</td> <td></td> <td></td> <td></td> </tr> <tr> <td> ◆ Actual Temp.</td> <td>(Export)</td> <td>Chamber temperature log</td> <td>36~38</td> </tr> <tr> <td> ◆ Door Opening</td> <td>(Export)</td> <td>Door opening log</td> <td>36~38</td> </tr> <tr> <td> ◆ Setting</td> <td>(Setting)</td> <td>Log interval, Unique ID</td> <td>32~33</td> </tr> <tr> <td> ◆ Alarm</td> <td>(Display)</td> <td>Alarm log (can be exported)</td> <td>39~40</td> </tr> <tr> <td> ◆ Alarm Export</td> <td>(Export)</td> <td>Alarm log</td> <td>41~42</td> </tr> </table>	◆ Export screen				◆ Actual Temp.	(Export)	Chamber temperature log	36~38	◆ Door Opening	(Export)	Door opening log	36~38	◆ Setting	(Setting)	Log interval, Unique ID	32~33	◆ Alarm	(Display)	Alarm log (can be exported)	39~40	◆ Alarm Export	(Export)	Alarm log	41~42																							
◆ Export screen																																																
◆ Actual Temp.	(Export)	Chamber temperature log	36~38																																													
◆ Door Opening	(Export)	Door opening log	36~38																																													
◆ Setting	(Setting)	Log interval, Unique ID	32~33																																													
◆ Alarm	(Display)	Alarm log (can be exported)	39~40																																													
◆ Alarm Export	(Export)	Alarm log	41~42																																													
◆ Key Lock	<table border="1"> <tr> <td>◆ Key Lock screen</td> <td>(Setting)</td> <td>Key lock ON/OFF, password</td> <td>26~29</td> </tr> </table>	◆ Key Lock screen	(Setting)	Key lock ON/OFF, password	26~29																																											
◆ Key Lock screen	(Setting)	Key lock ON/OFF, password	26~29																																													
◆ Tools	<table border="1"> <tr> <td>◆ Tools screen</td> <td></td> <td></td> <td></td> </tr> <tr> <td> ◆ Operation Setting</td> <td>(Setting)</td> <td>Eco operation ON/OFF, comp. delay time</td> <td>25~26</td> </tr> <tr> <td> ◆ Alarm Setting</td> <td>(Setting)</td> <td>Alarm delay, ring back, remote alarm etc.</td> <td>30~31</td> </tr> <tr> <td> ◆ DAQ Setting</td> <td></td> <td>Do not press (It is not possible to set.)</td> <td></td> </tr> <tr> <td> ◆ Date & Time</td> <td>(Setting)</td> <td>Date, time</td> <td>44</td> </tr> <tr> <td> ◆ Brightness/Sleep</td> <td>(Setting)</td> <td>Brightness, sleep ON/OFF etc.</td> <td>45~46</td> </tr> </table>	◆ Tools screen				◆ Operation Setting	(Setting)	Eco operation ON/OFF, comp. delay time	25~26	◆ Alarm Setting	(Setting)	Alarm delay, ring back, remote alarm etc.	30~31	◆ DAQ Setting		Do not press (It is not possible to set.)		◆ Date & Time	(Setting)	Date, time	44	◆ Brightness/Sleep	(Setting)	Brightness, sleep ON/OFF etc.	45~46																							
◆ Tools screen																																																
◆ Operation Setting	(Setting)	Eco operation ON/OFF, comp. delay time	25~26																																													
◆ Alarm Setting	(Setting)	Alarm delay, ring back, remote alarm etc.	30~31																																													
◆ DAQ Setting		Do not press (It is not possible to set.)																																														
◆ Date & Time	(Setting)	Date, time	44																																													
◆ Brightness/Sleep	(Setting)	Brightness, sleep ON/OFF etc.	45~46																																													

BASIC PARAMETERS

How to input numerical value and alphanumeric character

On each screen in the LCD touch panel, it may be necessary to input numerical value or alphanumeric characters.

•When inputting numerical value

1. By pressing numeric input box, numeric input window is displayed.

Numeric input box

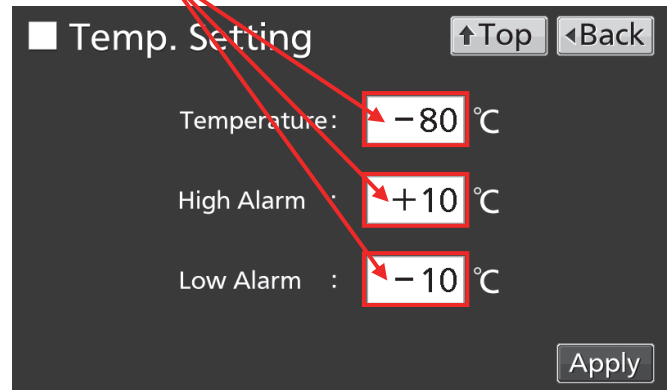

2. Press Numeric key or Up/Down key to input numerical value, and press OK key.

Numeric input window

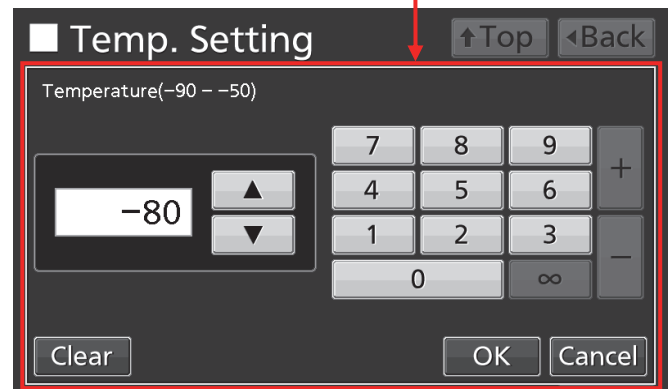

•Key description

- Numeric key (0~9): Input numerical value.
- Up/Down key (▲/▼): Increases or decreases the numerical value displayed in the numeric input box.
- Clear key: Deletes the numerical value displayed on the numeric input box.
- Cancel key: Stops inputting on the numeric input box and closes the input window.

Note: Up/Down key may not be displayed.

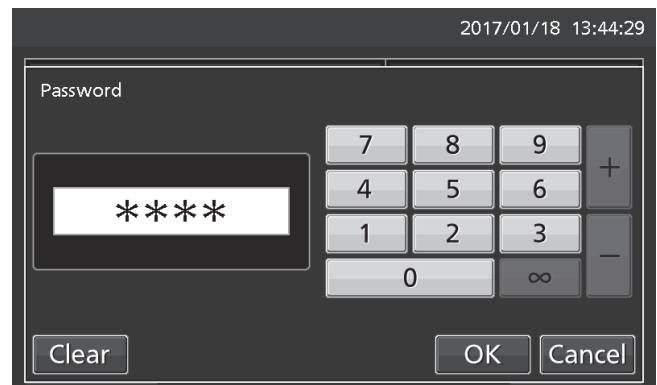

BASIC PARAMETERS

•When inputting alphanumeric characters

1. By pressing alphanumeric input box, alphanumeric input window is displayed.

Alphanumeric input box

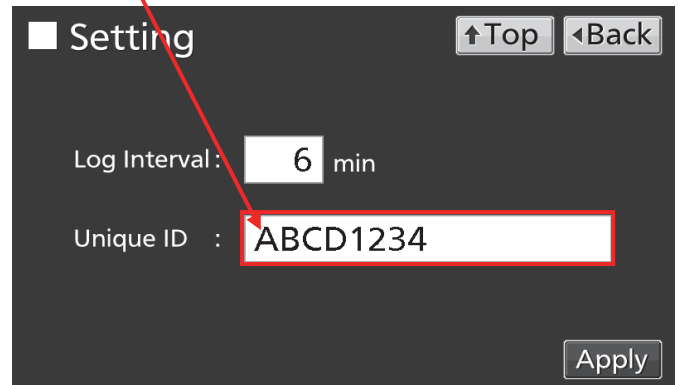

2. Press alphabetic key and numeric key to input alphanumeric characters, and press OK key.

Alphanumeric input window



•Key description

- Alphabetic key (A~Z, Space): Input alphabetic characters or spaces.
- Numeric key (0~9): Input numerical values.
- UC/LC key (A↔a): Change UC/LC of alphabetic key.
- Left/Right key (◀/▶): Move the cursor to left/right.
- Delete key: Delete an alphanumeric character on the left side of the cursor.
- Cancel key: Stops inputting on the alphanumeric input box and closes the alphanumeric input window.

Note: While the alphanumeric input window is open, it is not possible to operate Top key and Back key.

[Auto return function]

When there is no key operation for about 90 seconds on the screen excluding the top screen: Exit the setting mode and return to the top screen.

< When the sleep function is on >

When there is no key operation for about 90 seconds without alarm / error after sleep state: Exit the setting mode and return to the top screen.

BASIC PARAMETERS

Setting Temperature, High Alarm and Low Alarm

Set the Temperature, High Alarm and Low Alarm for normal operation according to the following procedure. The unit automatically starts operation using these settings after power-on.

1. Press Menu key to lead the Menu screen.

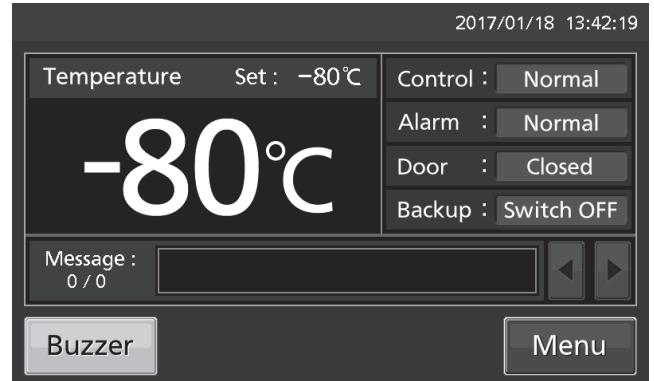

2. Press Set key to lead the Temp. Setting screen.

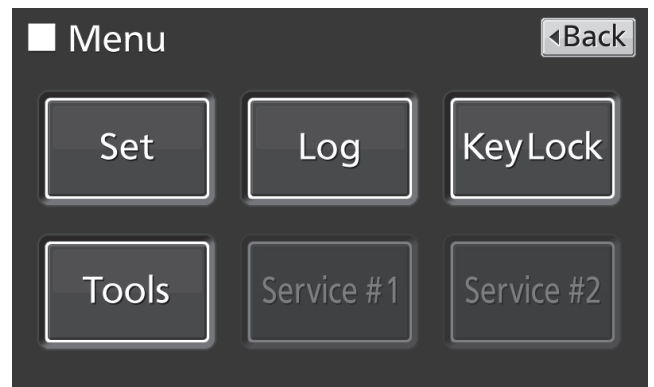

3. Input each parameter. Press Apply key to save the input value. The display returns to the Menu screen.

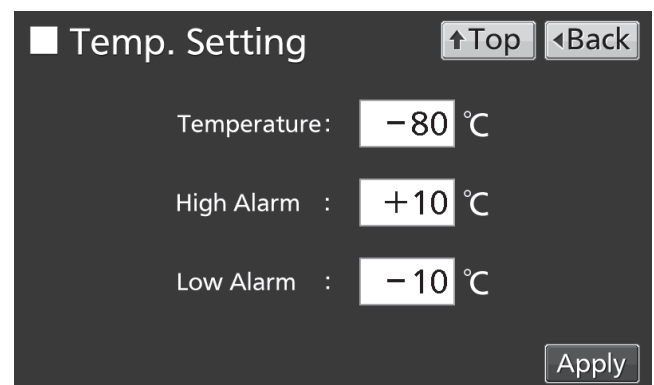

●Each parameter setting

• Temperature: Set value of chamber temperature.

Settable range: -90 °C~-50 °C, Control range: -86 °C~-50 °C, factory setting: -80 °C.

• High Alarm: When the chamber temperature exceeds the High Alarm set temperature (= the set temperature + the set value of High Alarm)*, the High Alarm is activated.

Settable range: +5 °C~+40 °C, factory setting: +10 °C.

• Low Alarm: When the chamber temperature falls below the Low Alarm set temperature (= the set temperature - the set value of Low Alarm)*, the Low Alarm is activated.

Settable range: -40 °C~-5 °C, factory setting: -10 °C.

BASIC PARAMETERS

* The current chamber temperature is the value rounded off below a decimal point, so the High/Low Alarm may be activated when the value of the current chamber temperature is equal to the High/Low Alarm set temperature.

4. On the Menu screen, press Back key to return to the Top screen.

Setting operation control mode

1. Press Menu key to lead the Menu screen.

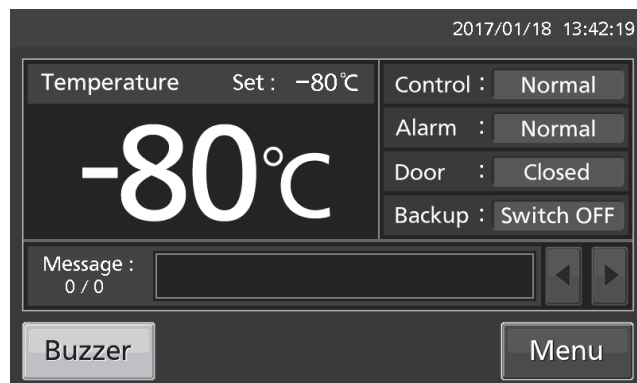

2. Press Tools key to lead the Tools screen.

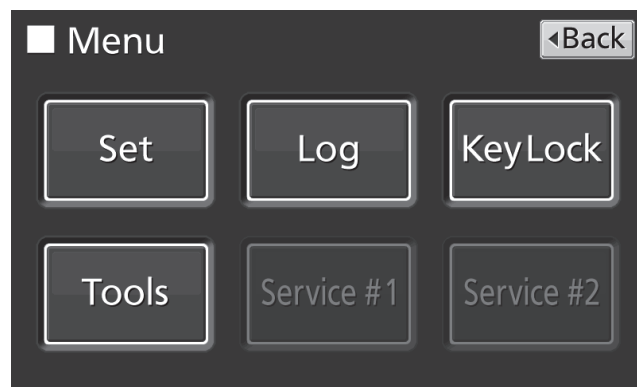

3. Press Operation Setting key to lead the Operation Setting screen.

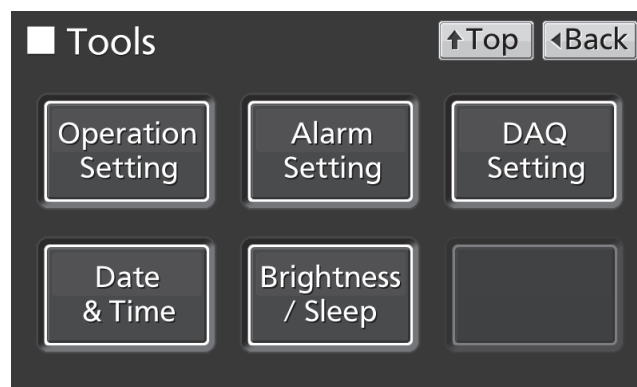

BASIC PARAMETERS

4. Input each parameter. Press Apply key to save the input value and setup. The display returns to the Tools screen.

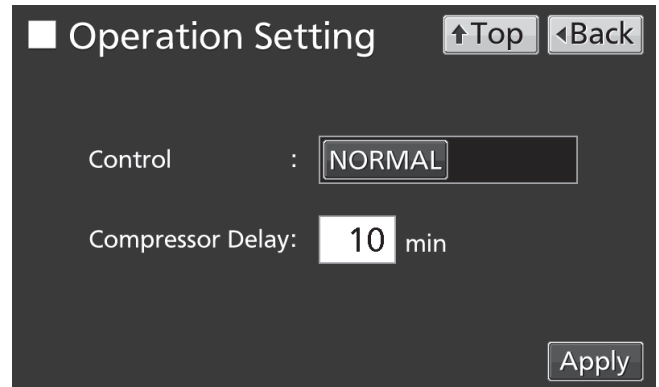

•Each setting

• Control:

Choose the operation control mode between the NORMAL (normal control) or the ECO (eco control). By holding the Control slide key and sliding it right, operation control mode is changed to ECO. Factory setting: NORMAL.

• Compressor Delay:

The time from turning ON this unit until starting its compressor. This unit is required a large electric power at the moment its compressor starts. When some units are in a same room, set so as to be shifted to each other the compressor delay times, to prevent the simultaneous start of all compressors after power failure. Settable range: 3 minutes~15 minutes, factory setting: 3 minutes.

Note: This unit has two compressor A and B. The compressor whose cumulative operating time is shorter than the other one, starts first, after 1 minute the other starts.

5. Press Top key to return to the Top screen.

Setting key lock

1. Press Menu key to lead the Menu screen.

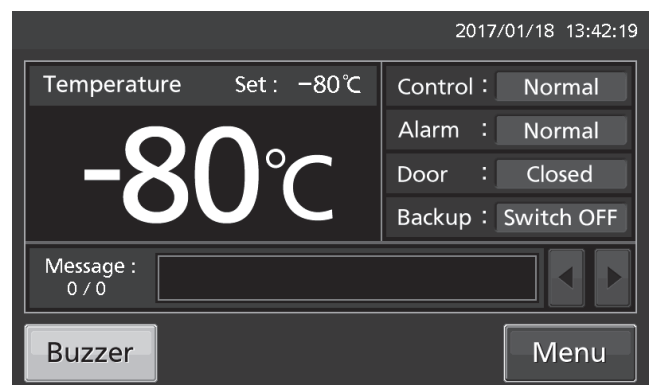

2. Press Key Lock key to lead the Key Lock screen.

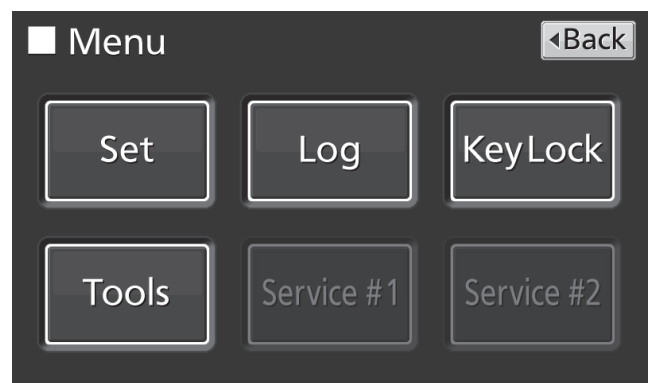

BASIC PARAMETERS

3. On the Key Lock screen, it is possible to set each setting of key lock.

- Key Lock: By holding Key Lock slide key and sliding it to the right, Key Lock turns to ON.

- Password #1: The number (Max. 6 digits) inputted here are registered the release password of Key Lock.

- Confirm Password #1:

To prevent erroneous input, input the same password as Password #1 input box. When inputting different password, Notice dialog box is displayed. Press OK key and input the correct password.

- By pressing Apply key, Key Lock turns to ON, password #1 is saved, and Confirm dialog box is displayed.

Yes: On the Key Lock screen, it is possible to set the release password #2.

No: The display returns to the Menu screen. Select [No] when it is no need to set the password #2.

Note: Two release passwords of Key Lock are settable. To release it, you can unlock by entering one of the passwords.

4. Set the password #2.

- Password #2: The number (Max. 6 digits) inputted here are registered the release password of Key Lock.

- Confirm Password #2:

To prevent erroneous input, input the same password as Password #2 input box. When inputting different password, Notice dialog box is displayed. Press OK key and input the correct password.

- By pressing Apply key, the password #2 is saved and Information dialog box is displayed.

The screenshot shows the 'Key Lock' screen with a title bar containing 'Key Lock', '↑Top', and '◀Back' buttons. Below the title bar, there are three rows of settings: 'Key Lock' with a toggle switch set to 'ON', 'Password #1' with an empty input field, and 'Confirm Password #1' with an empty input field. An 'Apply' button is located at the bottom right of the screen.

The screenshot shows the 'Key Lock' screen with a 'Notice' dialog box overlaid. The dialog box has a title bar 'Notice' and contains the text: 'The passwords do not match. Please retype in both boxes.' Below the text is an 'OK' button. The 'Apply' button from the background screen is visible at the bottom right.

The screenshot shows the 'Key Lock' screen with a 'Confirm' dialog box overlaid. The dialog box has a title bar 'Confirm' and contains the text: 'Key Lock Password #1 has been set. Are you sure to set Password #2?' Below the text are 'Yes' and 'No' buttons. The 'Apply' button from the background screen is visible at the bottom right.

The screenshot shows the 'Key Lock' screen with a title bar containing 'Key Lock', '↑Top', and '◀Back' buttons. Below the title bar, there are two rows of settings: 'Password #2' with an empty input field and 'Confirm Password #2' with an empty input field. An 'Apply' button is located at the bottom right of the screen.

BASIC PARAMETERS

5. On the Information screen, press OK key to return to the Menu screen.

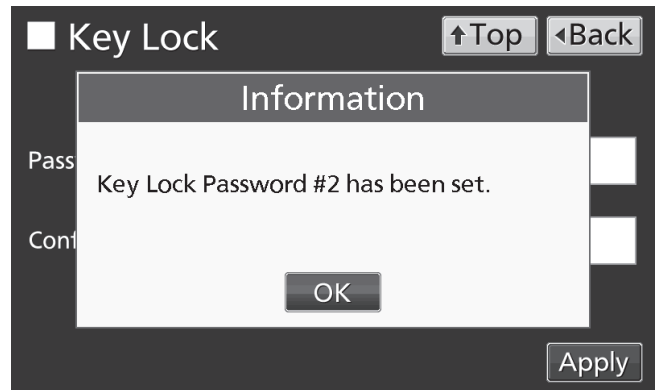

6. On the Menu screen, press Back key to return to the Top screen.

Note: Manage the release password of Key Lock properly.

•Operation for Keylock-ON

• When pressing Menu key, Password input box is displayed, and input of the release password of Key Lock is required. If two passwords are registered, you can unlock by entering one of the passwords.

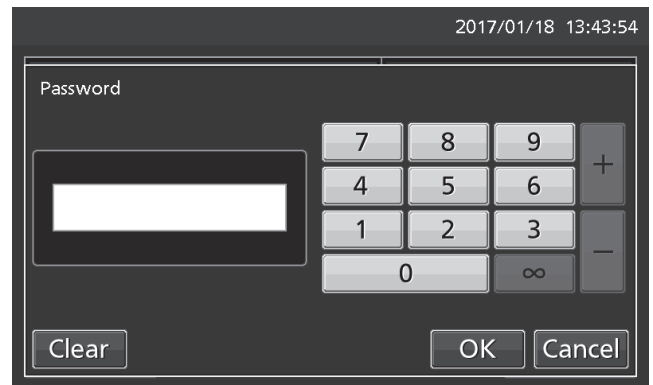

• When the inputted password is incorrect, Notice dialog box is displayed. Press OK key, and then input the correct password.

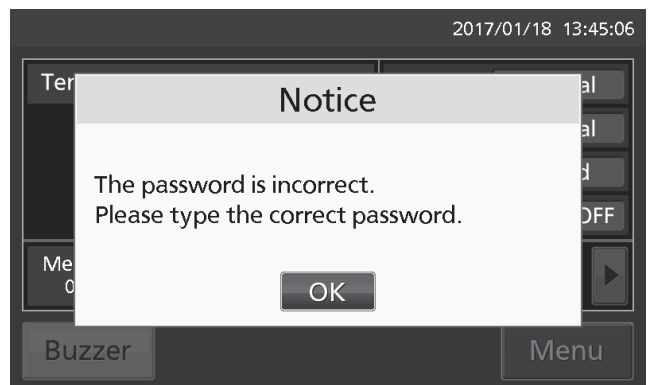

BASIC PARAMETERS

Removing key lock

1. By pressing Menu key, the Password input window is displayed.

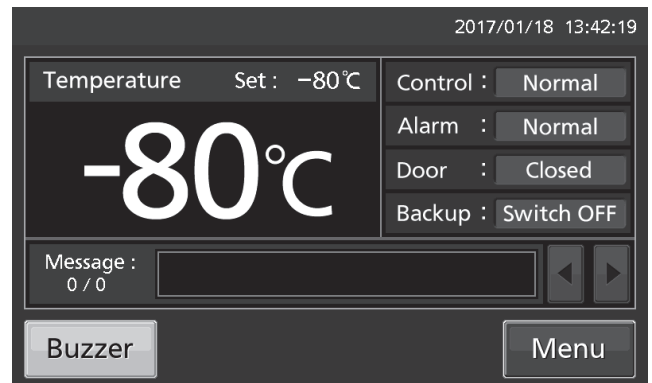

2. On Password input box, input the set release password (#1 or #2) of Key Lock, and press OK key to lead the Menu screen.



3. Press Key Lock key to lead the Key Lock screen.

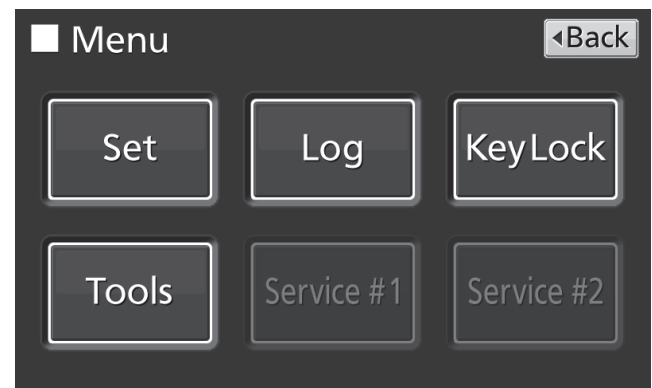

4. On the Key Lock screen, by holding Key Lock slide key and sliding to the left, change to OFF. Press Apply key to turn the key lock OFF. The display returns to the Menu screen.

Note: The release password of key Lock is deleted.

5. On the Menu screen, press Back key to return to the Top screen.

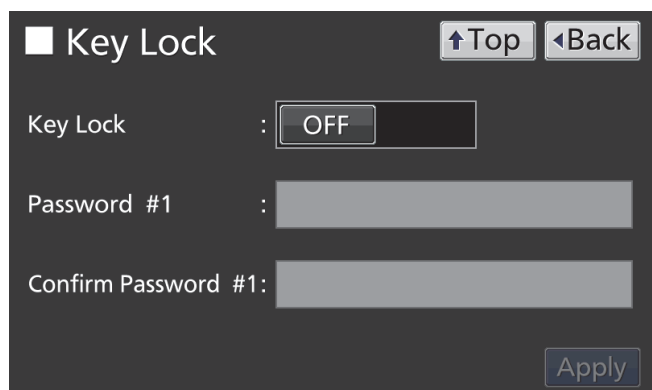

ALARM PARAMETERS

1. Press Menu key to lead the Menu screen.

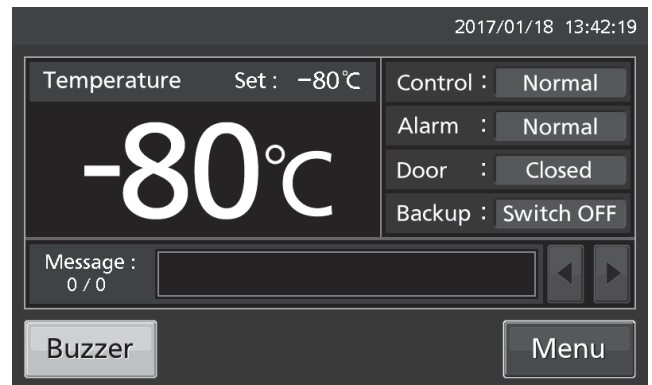

2. Press Tools key to lead the Tools screen.

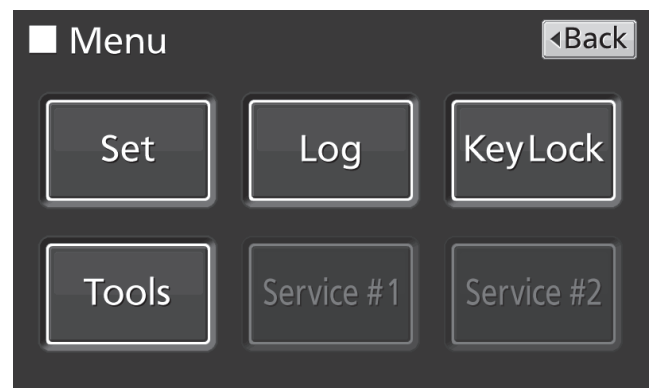

3. Press Alarm Setting key to lead the Alarm Setting screen.



ALARM PARAMETERS

4. On the Alarm Setting screen, it is possible to set each setting. Press Apply key to save the input value and setup. The display returns to the Tools screen.

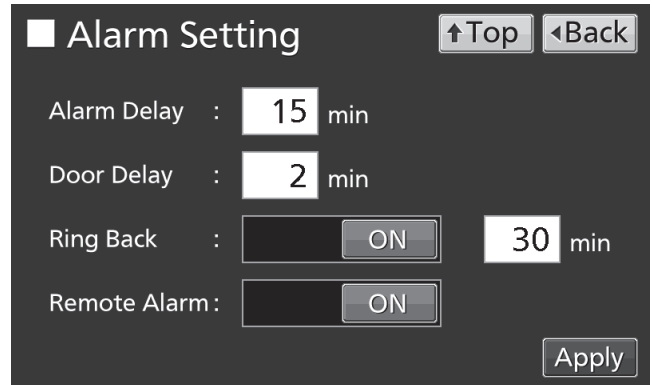

- Each setting
- Alarm Delay:

The function is that when the unit is in the alarm state of High Alarm or Low Alarm, the alarm buzzer will sound after the alarm delay set time passed.

Settable range: 0 minute~15 minutes, factory setting: 15 minutes.

Note: When the unit is recovered from the alarm state within the alarm delay time, the buzzer does not sound after the elapse of the alarm delay.

- Door Delay:

The function is that when the unit is in the alarm state of door, the alarm buzzer will sound after the alarm delay set time passed. Settable range: 0 minute~15 minutes, factory setting: 2 minutes.

Note: When the unit is recovered from the alarm state within the door alarm delay time, the buzzer does not sound after the elapse of the door alarm delay.

- Ring Back:

The function is that the alarm buzzer sounds again when the alarm state still continues after the ring back set time passed even though the alarm buzzer was stopped by pressing Buzzer key. By holding and sliding Ring Back slide key to the right, the Ring Back is turned to ON.

Settable range: 1 minute~99 minutes, factory setting: 30 minutes.

Note: At Door alarm, the alarm is not re-activated because the alarm itself is deactivated by pressing Buzzer key [page 49].

- Remote Alarm:

The function is that the remote alarm is continued even though the buzzer is stopped by pressing Buzzer key. By holding and sliding Remote Alarm slide key to the right, the Remote Alarm is turned to ON (not in conjunction with Buzzer key). Factory setting: ON.

5. Press Top key to return to the Top screen.

- At the alarm state

• While the unit's alarm is being activated and the buzzer is being sounding, the buzzer is silenced by pressing Buzzer key. For the behavior at the time of pressing Buzzer key and the re-activation of alarm, under each setting condition, refer to Table 2-3 on page 49.

Resolve the cause of the alarm in reference to pages 47 - 49 because the alarm itself is not deactivated by pressing Buzzer key except for some alarms.

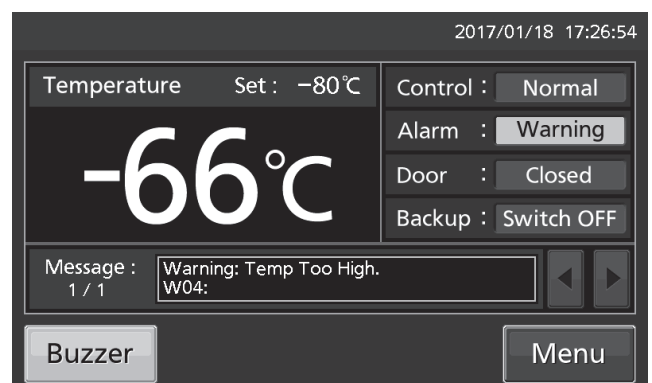

OPERATION/ALARM LOG

Setting log interval

The unit is equipped with a function of saving operation log data (chamber temperature and open/close state of door).

Note: When the battery switch for power failure alarm is ON, operation log is saved during a power failure.

Use the following procedure to set the log interval (interval of acquiring the operation log).

1. Press Menu key to lead the Menu screen.

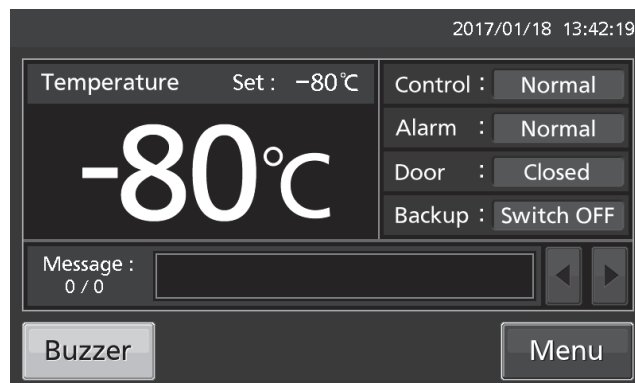

2. Press Log key to lead the Log screen.

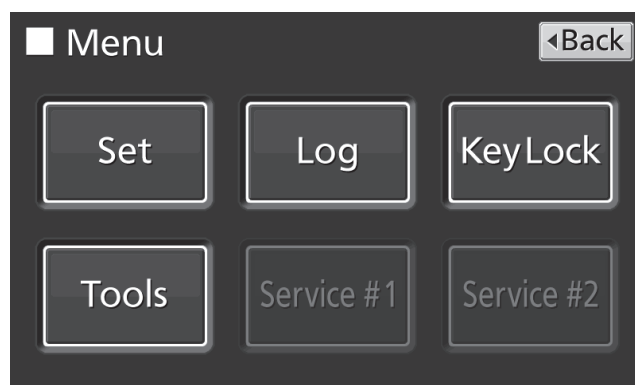

3. Press Setting key to lead the Setting screen.



OPERATION/ALARM LOG

4. On the Setting screen, input Log Interval. Press Apply key to save the input value. The display returns to the Log screen.

Settable range: 2 minutes~30 minutes.

Factory setting: 6 minutes.

Note: Only an even number can be inputted. When inputting an odd number and when pressing OK key in the numeric input window, it changes to an even number which is 1 smaller than that.

Note: It is possible to register 8-digit alphanumeric characters as the Unique ID [page 38].



Note: Relation between log interval and the estimated amount of data that can be saved

Log interval=2 minutes: Approx. 46 days

Log interval=6 minutes: Approx. 135 days

Log interval=30 minutes: Approx. 664 days

When saving data more than the above, and the data is overwritten and the old data is deleted.

5. Press Top key to return to the Top screen.

Displaying operation log

Operation log saved in the freezer can be displayed graphically on the LCD touch panel.

1. Press Menu key to lead the Menu screen.

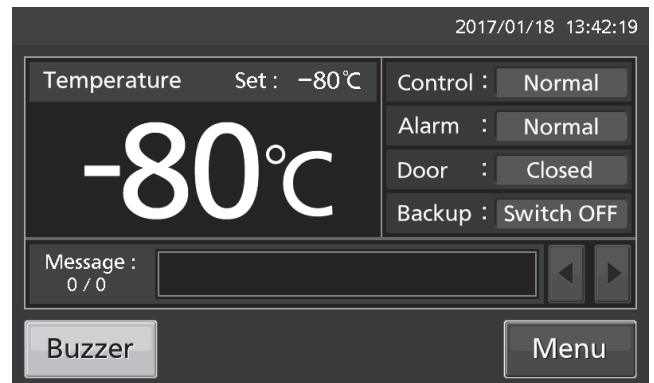

2. Press Log key to lead the Log screen.

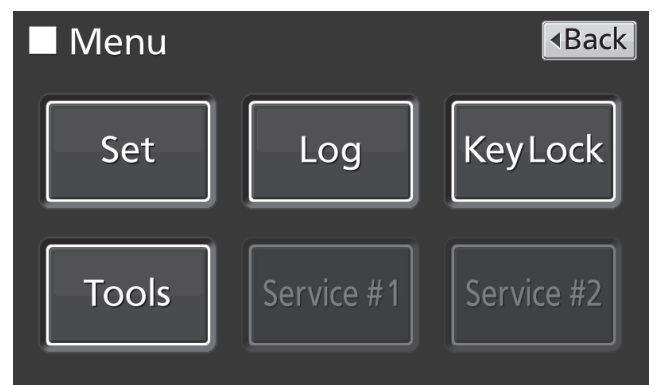

OPERATION/ALARM LOG

3. Press Chart key to lead the Chart screen.



4. On the Chart screen, input the date (year / month / day) of the operation log you want to display graphically.

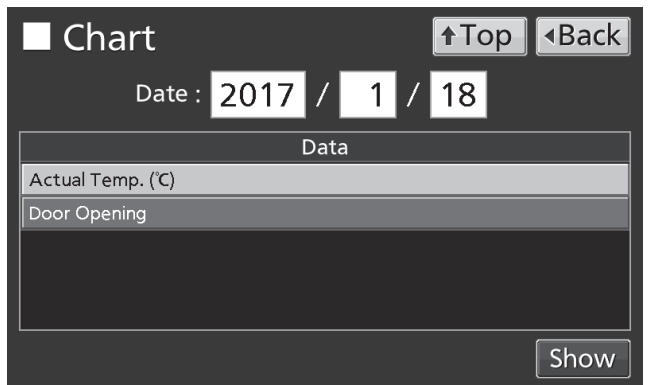

5. On the Chart screen, by pressing Show key after pressing the item you want to display graphically, the graph of each operation log is displayed.

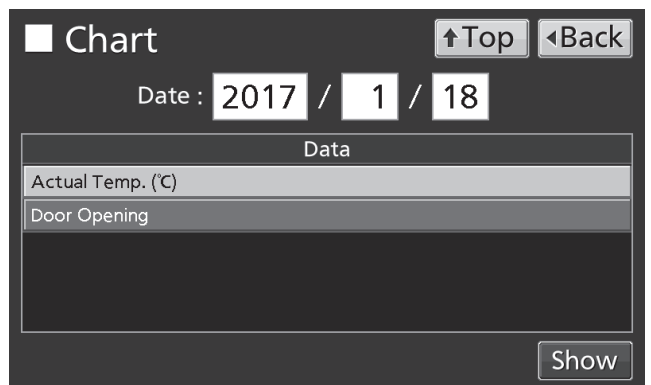

- Actual Temp.:
Chamber temperature log graph
(Go to procedure 6)
- Door Opening:
Open/close state of door log graph
(Go to procedure 7)

6. Actual Temp. log graph is displayed.

- Press Back key to return to the Chart screen.
- Press Top key to return to the Top screen.

To previous day To next day

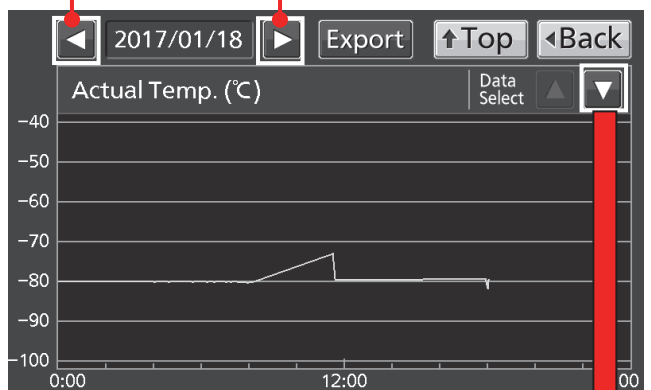

To Door Opening log

OPERATION/ALARM LOG

7. Door Opening log graph is displayed.

- Press Back key to return to the Chart screen.
- Press Top key to return to the Top screen.

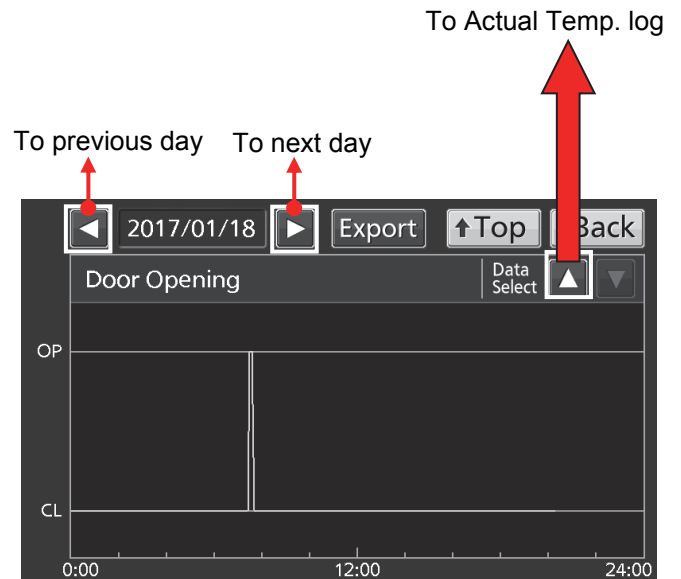

• On the Chart screen of procedure 6 or 7 log data can be exported in CSV format to the USB memory inserted into the USB port.

8. Insert the USB memory into the USB port.

Note: It is not possible to use a USB memory with security functions that requires entering password.

9. Press Export key.

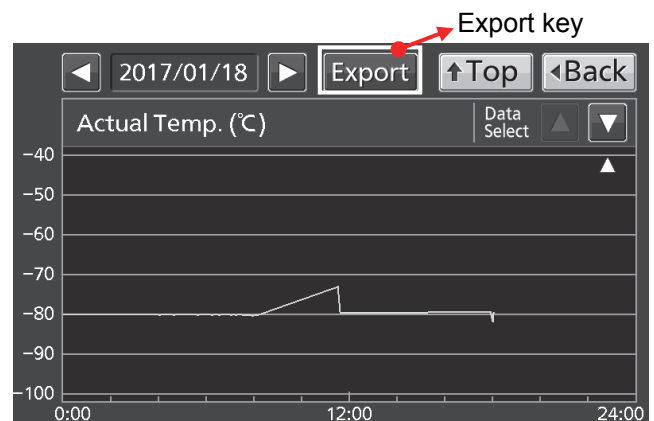

10. When the export is complete, Information dialog box is displayed. Press OK key. Refer to pages 37 and 38 for the details about abnormal export or exported file name.

11. Press Top key to return to the Top screen.

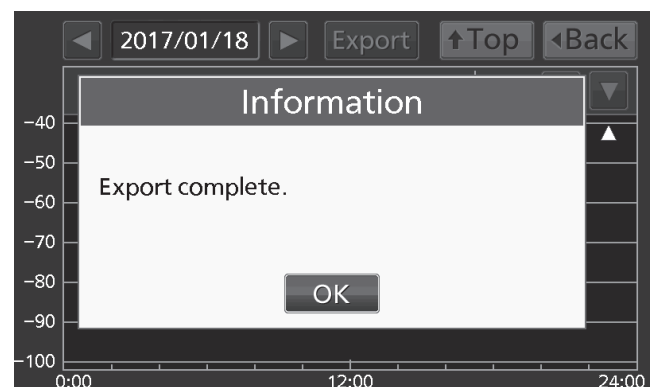

OPERATION/ALARM LOG

Exporting operation log

Operation log data saved in the freezer can be exported in CSV format to the USB memory inserted into the USB port.

1. Insert the USB memory into the USB port.

Note: It is not possible to use a USB memory with security functions that requires entering password.

2. Press Menu key to lead the Menu screen.

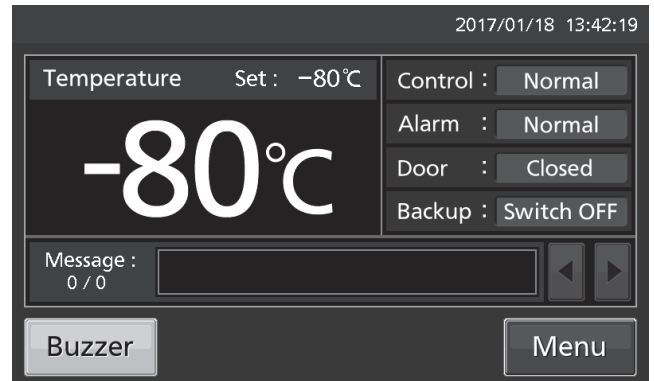

3. Press Log key to lead the Log screen.

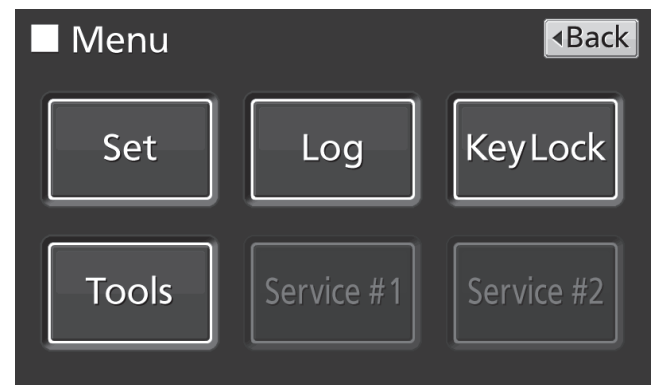

4. Press Data Export key to lead the Export screen.



OPERATION/ALARM LOG

5. On the Export screen, select the time period you want to export.

- To export the saved operation log data over the entire period, press All radio button.

- To export the operation log data of a specified date, press 1 Day radio button and input the date (year / month / day) of the operation log data you want to export.

Note: The error of about 1 minute may be observed during a month. Refer to page 44 for the procedure of setting time.

6. On the Export screen, select the type of operation log data you want to export.

- To export all types of operation log data, press All Ch key.

- To export only operation log data you want to export, select operation log data you want to export, and then press Selected Ch key.

- Actual Temp.: Chamber temperature log data

- Door Opening: Open/close state of outer door log data

Note: When no USB memory is inserted into the USB port, Notice dialog box is displayed. Press OK key, and then insert a USB memory into the USB port.

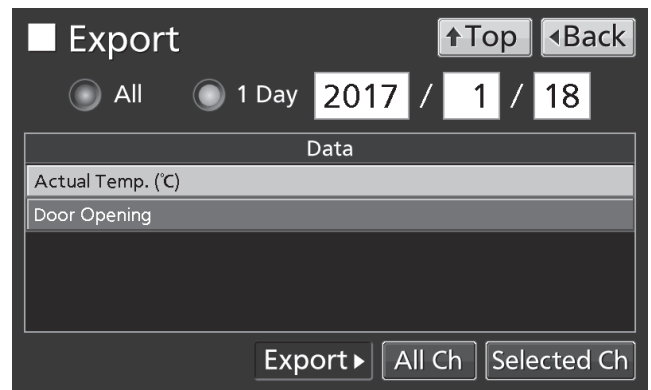
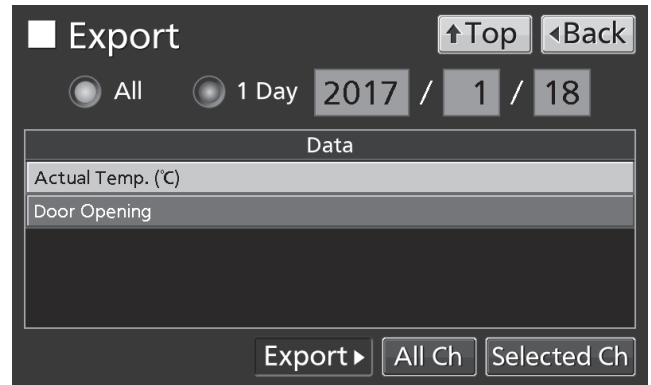

OPERATION/ALARM LOG

Note: When the specified operation log data does not exist, Notice dialog box is displayed. Press OK key, and then re-specified according to procedure 5 and 6.

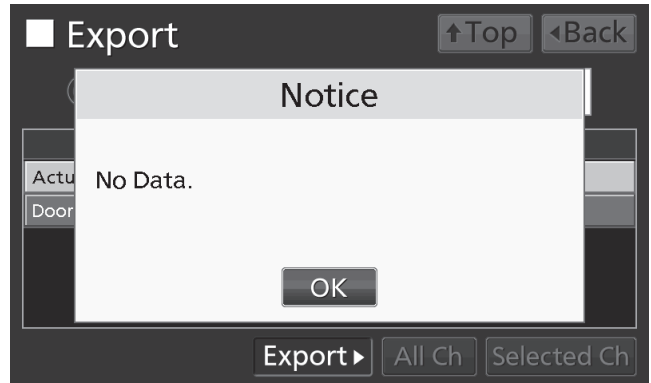

7. When the export is complete, Information dialog box is displayed. Press OK key.

Note: Even after the export of operation log data is complete, operation log data saved in the unit are not deleted.

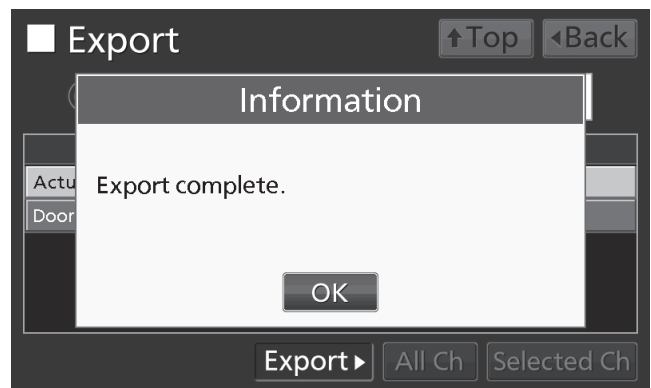

8. Remove the USB memory from the USB port.

Note:

- The log folder is created in the USB memory, and the exported file is saved in it in CSV format. The exported file name is in date (8 digits) - type of data format.

(e.g.) When exporting all types of data using All (from Jan. 1st, 2017 to Oct. 1st, 2017):

20170101-20171001_AllCh.csv

20170101-20171001_Door.csv

(e.g.) When exporting Actual Temp. using 1 Day (Jan. 1st, 2017):

20170101_Temp.csv

◇ If the file name is duplicated, A sequential number such as "-1" is added to the end of the file name to be output later.

- On the beginning of the exported file, product name ("MDF-DU502VX" or "MDF-DU702VX") is written. However when the Unique ID is registered [page 33], product name and Unique ID (8-digit) are written.

(e.g.) When "RoomA001" is set as the Unique ID of MDF-DU502VX:

MDF-DU502VX, RoomA001

9. Press Top key to return to the Top screen.

OPERATION/ALARM LOG

Displaying alarm log

The unit is equipped with a function of saving alarm log data (Max. 256 logs).

Note:

- When saving alarm logs more than 257, the oldest alarm log is deleted, and then overwritten.
- When the battery switch for power failure alarm is ON, operation log is saved during a power failure.

Alarm log saved in the freezer can be displayed graphically on the LCD touch panel.

1. Press Menu key to lead the Menu screen.

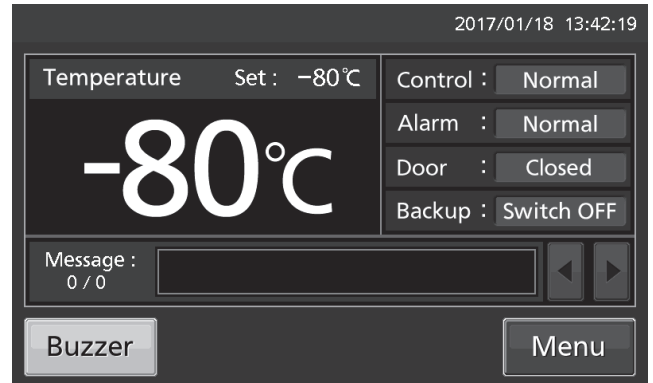

2. Press Log key to lead the Log screen.

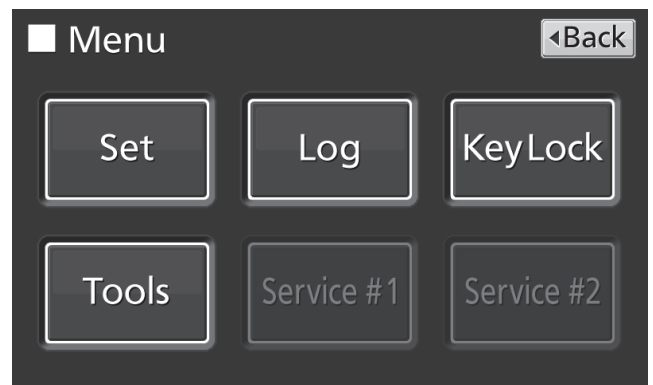

3. Press Alarm key to lead the Alarm screen.



OPERATION/ALARM LOG

4. On the Alarm screen, the newest 7 days' alarm logs (containing that day) are displayed.

Note: When the number of applicable alarm log is 6 or more, by pressing the top (▲) or the bottom (▼) log, the log table currently displayed scrolls and hidden alarm logs can be seen.

- Press Back key to return to the Log screen.
- Press Top key to return to the Top screen.

5. On the Alarm screen, by inputting days into the Last XX Days input box, alarm logs for specified days (containing that day) are displayed.

Settable range: 1 day~45 days.

Note: The error of about 1 minute may be observed during 1 month. Refer to page 44 for the procedure of setting time.

- Press Back key to return to the Log screen.
- Press Top key to return to the Top screen.

• On the Alarm screen of procedure 4 or 5, alarm log data can be exported in CSV format to the USB memory inserted into the USB port.

6. Insert the USB memory into the USB port.

Note: It is not possible to use a USB memory with security functions that requires entering password.

7. Press Export key.

8. When the export is complete, Information dialog box is displayed. Press OK key. Refer to pages 42 and 43 for the details about abnormal export or exported file name.

9. Press Top key to return to the Top screen.

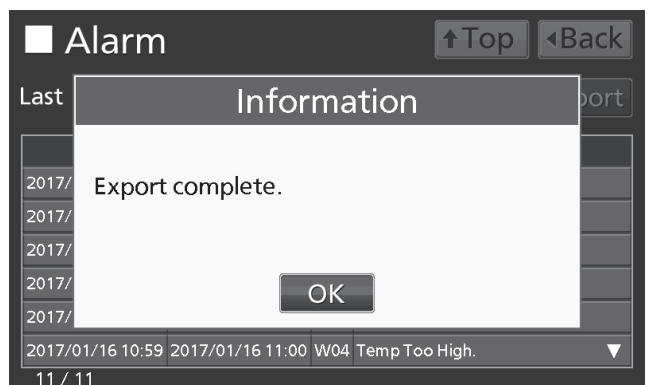
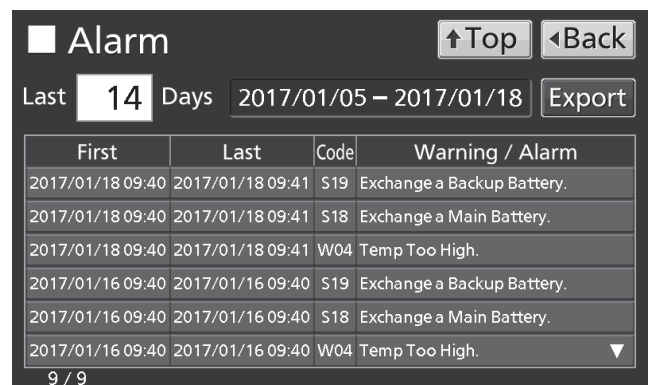
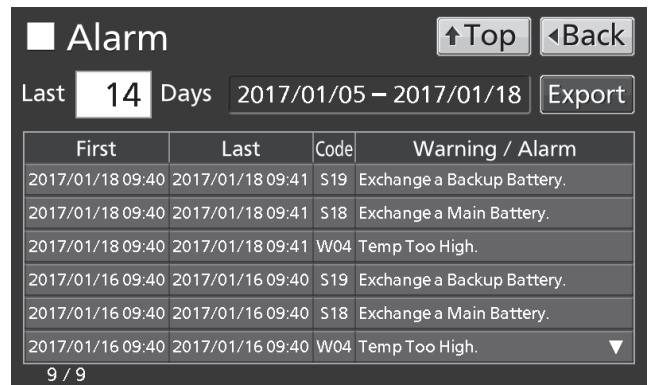
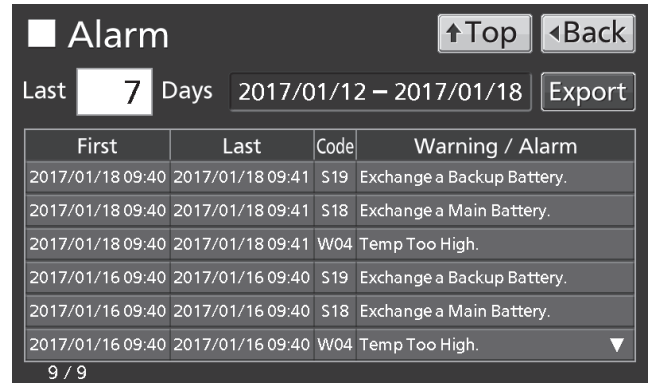

OPERATION/ALARM LOG

Exporting alarm log

It is possible to export saved alarm log data to a USB memory inserted in the USB port by CSV format.

1. Insert a USB memory in the USB port.

Note: It is not possible to use a USB memory with security functions that requires entering password.

2. Press Menu key to lead the Menu screen.

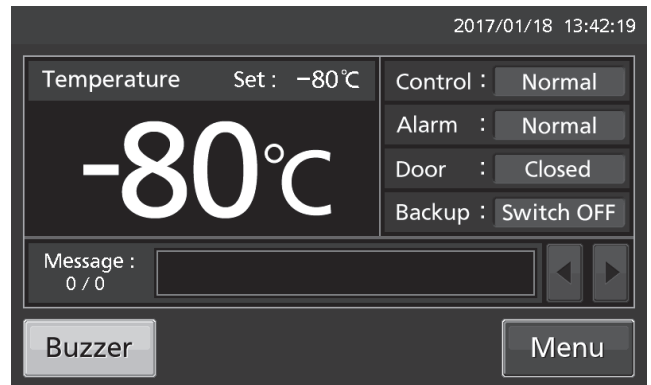

3. Press Log key to lead the Log screen.

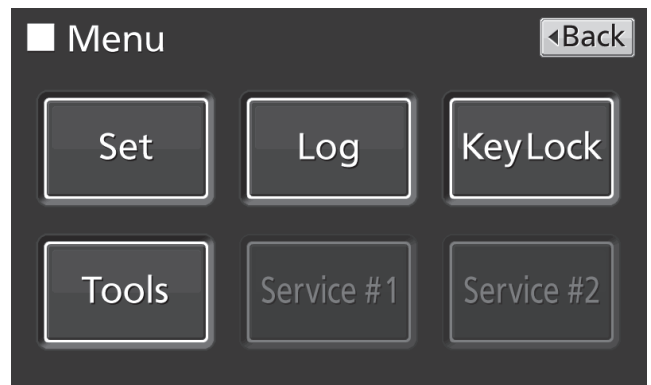

4. Press Alarm Export key to lead Alarm Export screen.



OPERATION/ALARM LOG

5. On the Alarm Export screen, select the period to export.

- To export the saved alarm log data over the entire period, press All radio button.
- To export the alarm log data for the specified days (The newest period containing that day), press Last XX Days radio button and input days. Settable range: 1 day~45 days.

Note: The error of about 1 minute may be observed during 1 month. Refer to page 44 for the procedure of setting time.

6. Press Export key.

Note:

- When USB memory is not inserted in the USB port, Notice dialog box is displayed. Press OK key and insert an USB memory into the USB port.

- When alarm log data does not exist in the specified days, Notice dialog box is displayed. Press OK key and specify days again as shown in the procedure 5.

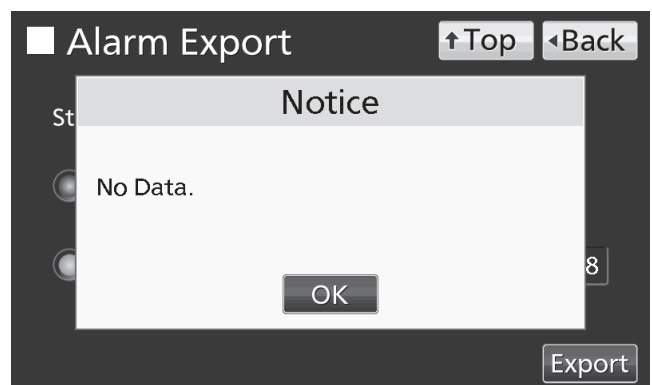
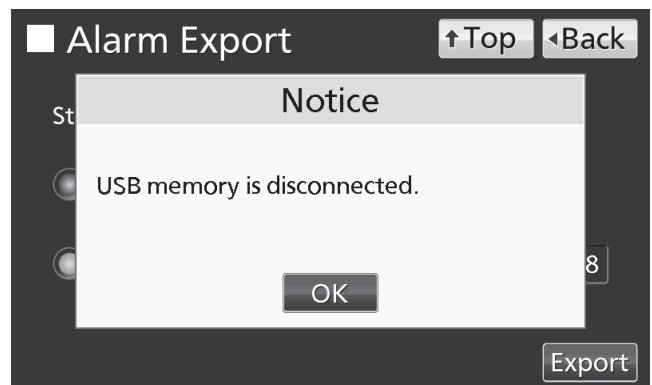

OPERATION/ALARM LOG

7. Even after completion the export of alarm log data, Information dialog box is displayed. Press OK key.

Note: After completing the export of alarm log data, alarm log data saved at unit is not deleted.

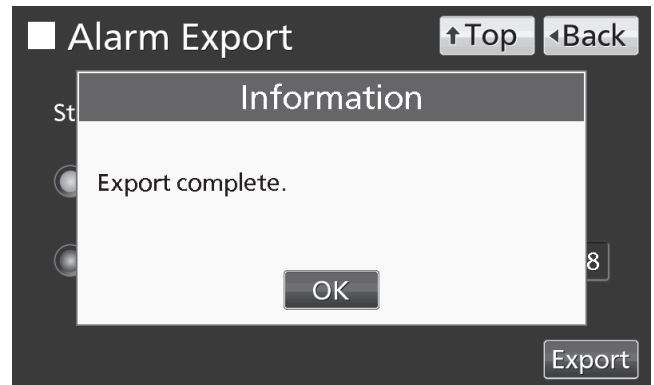

8. Remove a USB memory from the USB port.

Note: A log folder is created in a USB memory, and an exported data file is saved in the log folder by CSV format.

Exported file name; The first date during exported period (8 digits) + the last date (8 digits) + AlarmLog Example) When exporting alarm log data for 7 days on January 7, 2017;

20170101-20170107_AlarmLog.csv

✧ If the file name is duplicated, A sequential number such as "-1" is added to the end of the file name to be output later.

9. Press Top key to return to the Top screen.

OTHER PARAMETERS

Setting date and time

1. Press Menu key to lead the Menu screen.

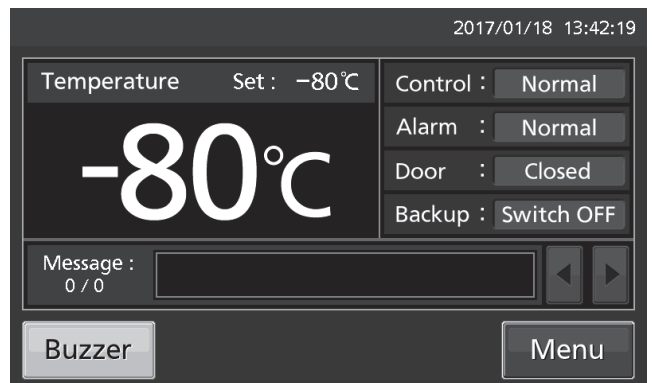

2. Press Tools key to lead the Tools screen.

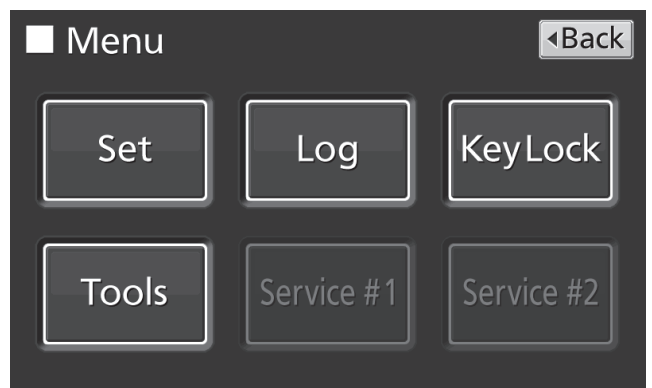

3. Press Date & Time key to lead the Date & Time screen.



4. On the Date & Time screen, input the present date and time. Press Apply key to save the input value. The display returns to the Tools screen.

Note:

- 24-hour clock.
- It is recommended to set the time periodically since the error of about 1 minute may be observed during a month.

5. Press Top key to return to the Top screen.

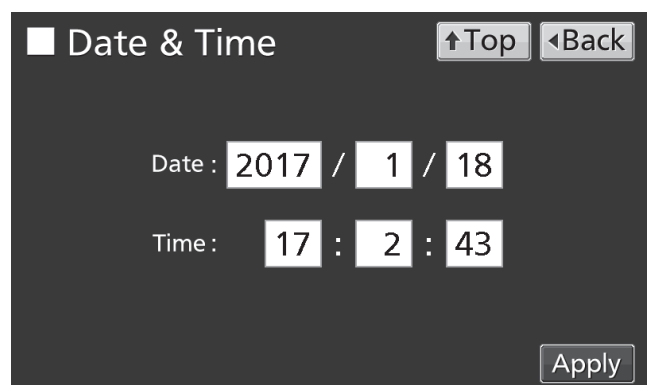

OTHER PARAMETERS

Setting brightness and sleep

1. Press Menu key to lead the Menu screen.

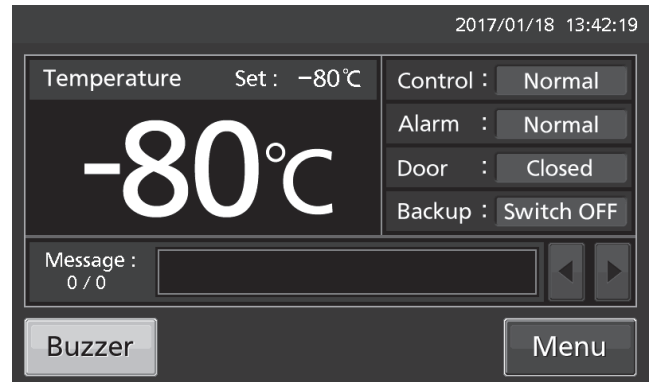

2. Press Tools key to lead the Tools screen.

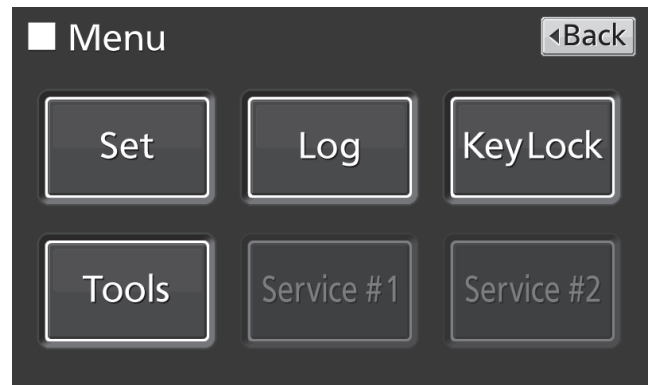

3. Press Brightness/Sleep key to lead the Brightness/Sleep screen.



4. On the Brightness/Sleep screen, each setting of brightness and sleep is available. Press Apply key to save the input value and setup. The display returns to the Tools screen.

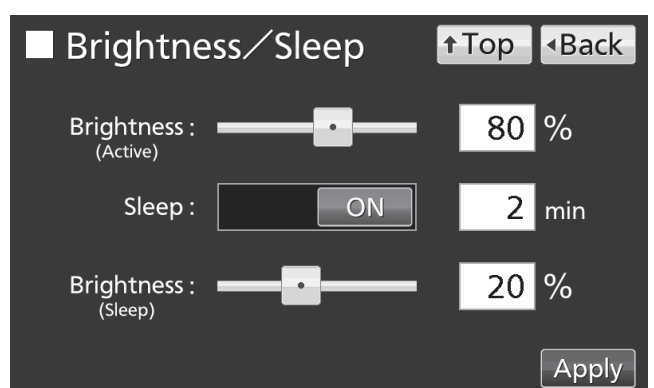

OTHER PARAMETERS

- Each setting

- Brightness(Active):

Brightness of LCD touch panel of the usual state. Adjust Brightness(Active) slide bar or input set value into the Brightness(Active) input box. Settable range: 50~100, factory setting: 80.

- Sleep:

The function is that the brightness of LCD touch panel is lowered to save electricity, when there is no key operation during set time.

By holding the Sleep slide key and sliding it right, the Sleep function is turned to ON. Input the set value of time to change the Sleep state. Settable range: 1 minute~5 minutes, factory setting: 2 minutes.

Note: It is not possible to operate any key in the Sleep state. By touching the LCD touch panel, the Sleep state is released and the LCD touch panel returns to the usual state. Under this condition, key operations are available.

- Brightness(Sleep):

Brightness of LCD touch panel of the Sleep state. Adjust Brightness(Sleep) slide bar or input set value into the Brightness(Sleep) input box. Settable range: 0~50, factory setting: 20.

5. Press Top key to return to the Top screen.

ALARMS AND SELF-DIAGNOSIS

Warning: The cooling performance is significantly reduced. The chamber temperature may get higher considerably. Take some precautions for the storage items immediately (transferring the storage items to another freezer or placing of dry ice wrapped in newspaper in the chamber) except when the cause is clear and the chamber temperature can be recovered soon.
Contact our sales representative or agent after turning off the power switch.

LCD touch panel Message display field	Situation	Buzzer	Remote alarm	Alarm & safety
Warning: Temp Control Failure. W01: Power Failure.	The battery switch for power failure alarm is ON, and under any of the following conditions. •During a power failure •Power switch is OFF •Power supply cord is disconnected.	Intermittent tone	Alarm mode	Power failure alarm
Warning: Temp Control Failure. *1 W02: Compressor 'A' Temp Abnormal.	Compressor 'A' Temp Abnormality.			Compressor 'A' Temp Abnormality *1
Warning: Temp Control Failure. *1 W03: Compressor 'B' Temp Abnormal.	Compressor 'B' Temp Abnormality.			Compressor 'B' Temp Abnormality *1
Warning: Temp Too High. W04	If the chamber temperature exceeds the set temp. + the set value of High Alarm.			High Alarm
Warning: Temp Too Low. W05	If the chamber temperature falls below the set temp. - the set value of Low Alarm.			Low Alarm
Warning: Temp Control Failure. *3 W08: Temperature Controller Failure.	When communication between LCD touch panel and control substrate is died out or unstable.	—	—	Communication error
Warning: Temp Control Failure. *2 W09: Temperature Sensor Error.	If the thermal sensor is disconnected.	Intermittent tone	Alarm mode	Temperature Sensor disconnected *2
Warning: Temp Control Failure. *2 W10: Temperature Sensor Error.	If the thermal sensor is short-circuited.			Temperature Sensor short-circuited *2
Warning: Temp Control Risk. W11: Compressor 'A' Control Failure.	Compressor 'A' does not start-up. Or, diagnostic sensor failure.	—	—	A Compressor Start-up failure.
Warning: Temp Control Risk. W12: Compressor 'B' Control Failure.	Compressor 'B' does not start-up. Or, diagnostic sensor failure.	—	—	B Compressor Start-up failure.
Warning: Temp Control Risk. W13: Compressor 'A' Control Failure.	Compressor 'A' does not stop. Or, diagnostic sensor failure.	—	—	A Compressor Stop failure.
Warning: Temp Control Risk. W14: Compressor 'B' Control Failure.	Compressor 'B' does not stop. Or, diagnostic sensor failure.	—	—	B Compressor Stop failure.

*1: The compressor stops in the case of W02 or W03.

*2: The compressor runs continuously in the case of W09 or W10.

The compressor stop has a priority over the continuous running if the above two errors come up at one time.

*3: The chamber temperature is not displayed in the case of W08

Alarm: Cooling performance may decline and the temperature of the chamber may rise. Wait for the recovery of chamber temperature if the temperature change is temporary resulting from user operation. For other cases, failure or chamber temperature rise may cause if this status continues.

Take some precautions for the storage items (transferring the storage items to another freezer or placing of dry ice wrapped in newspaper in the chamber).

Contact our sales representative or agent.

LCD touch panel Message display field	Situation	Buzzer	Remote alarm	Alarm & safety
Alarm: Temp Too High. A04	If the chamber temperature exceeds the set temp. + the set value of High Alarm.	Intermittent tone	—	High Alarm
Alarm: Temp Too Low. A05	If the chamber temperature falls below the set temp. - the set value of Low Alarm.			Low Alarm
Alarm: Temp Control Risk. A06: Cooling Circuit 'A' Abnormal.	The performance of the cooling circuit "A" gets worse.			Cooling circuit abnormality
Alarm: Temp Control Risk. A07: Cooling Circuit 'B' Abnormal.	The performance of the cooling circuit "B" gets worse.			
Alarm: Temp Control Risk. A08: Fan Motor 'A' Abnormal.	Fan motor "A" failure.			Fan Motor 'A' Abnormality
Alarm: Temp Control Risk. A09: Fan Motor 'B' Abnormal.	Fan motor "B" failure.			Fan Motor 'B' Abnormality

ALARMS AND SELF-DIAGNOSIS

Status: There is a possibility of failure other than the cooling performance. The chamber temperature is under control. The alarm may not be triggered in the case of any failure if this status continues
Contact our sales representative or agent.

LCD touch panel Message display field	Situation	Buzzer	Remote alarm	Alarm & safety
Status: Temp Control Risk. *4 S01: Cooling Circuits Overload.	When the chamber temp. does not reach the set temp. for approx. 5 days or more.	—		Overload operation *4
Status: Temp Under Control. *5 S02: Ambient Temp Abnormal.	When the ambient temp. is over 35 °C or lower than 0 °C.			Abnormal ambient temperature *5
Status: Temp Under Control. S03: Air Intake Port Heater Failure.	Heater failure.	Intermittent tone		Air Intake Port Heater Failure
Status: Temp Under Control. S04: Compressor Sensor 'A' Error.	Compressor sensor 'A' is disconnected.	Intermittent tone		Compressor Sensor 'A' disconnected
Status: Temp Under Control. S05: Compressor Sensor 'A' Error.	When the compressor sensor 'A' is short-circuited.			Compressor Sensor 'A' short-circuited
Status: Temp Under Control. S06: Compressor Sensor 'B' Error.	Compressor sensor 'B' is disconnected.			Compressor Sensor 'B' disconnected
Status: Temp Under Control. S07: Compressor Sensor 'B' Error.	When the compressor sensor 'B' is short-circuited.			Compressor Sensor 'B' short-circuited
Status: Temp Under Control. S08: Thermocouple 'A' Abnormal.	Diagnostic sensor failure.			Thermocouple 'A' Abnormality
Status: Temp Under Control. S09: Thermocouple 'B' Abnormal.	Diagnostic sensor failure.			Thermocouple 'B' Abnormality
Status: Temp Under Control. S14: Ambient Temp Sensor Error.	If the ambient temp. sensor is disconnected.			Ambient Temp Sensor disconnected
Status: Temp Under Control. S15: Ambient Temp Sensor Error.	If the ambient temp. sensor is short-circuited.			Ambient Temp Sensor short-circuited
Status: Temp Under Control. S16: Main Battery Charging Failure.	When the battery voltage does not increase after certain period.			Main Battery Charging Failure
Status: Temp Under Control. S17: Backup Battery Charging Failure.				Backup Battery Charging Failure
Status: Temp Under Control. S18: Exchange a Main Battery.	When the cumulative operating time exceeds about 3 years.	Intermittent tone (After door delay time has elapsed.)		Battery for power failure alarm replacement
Status: Temp Under Control. S19: Exchange a Backup Battery.	When about 3 years passed after installing backup cooling kit.			Battery for backup cooling kit replacement
Status: Temp Under Control. S20: Battery Inactive, SW may be OFF.	When the battery switch for power failure alarm is OFF.			Battery switch check
Door Open.	When door is open.			Door alarm

*4: In the case of S01, check the following:

- (1) There are too many items stored inside the chamber at a time.
- (2) The door is frequently opened. The door seal is damaged.
- (3) The set chamber temperature is higher than -80 °C.

*5: Check the air conditioning at the installation site in the case of S02.

The ambient temperature should be 5 °C~30 °C.

ALARMS AND SELF-DIAGNOSIS

•Table 2~3 show the behavior of the alarm (buzzer) and Ring Back function when pressing Buzzer key.

Table 2 In the cases of other than the door alarm.

Remote Alarm setting	Ring Back setting	Buzzer from unit		Remote Alarm	
		When pressing Buzzer key	When the Ring Back set time passes	When pressing Buzzer key	When the Ring Back set time passes
ON: Non-interlock with Buzzer key	ON	OFF (Alarm is not canceled)	ON	ON	ON (Under continuation)
	OFF		OFF		
OFF: Interlock with Buzzer key	ON		ON	OFF (Alarm is not canceled)	
	OFF		OFF		

Note: Resolve the cause of the alarm in reference to pages 47 - 48 because the alarm itself is not deactivated by pressing Buzzer key.

Table 3 In the cases of the door alarm.

Remote Alarm setting	Ring Back setting	Buzzer from unit		Remote Alarm setting
		When pressing Buzzer key	When the Ring Back set time passes	
ON: Non-interlock with Buzzer key	ON	OFF (Alarm is canceled)	OFF (Alarm is already canceled)	OFF
	OFF			
OFF: Interlock with Buzzer key	ON			
	OFF			

•Table 4 shows the situation after being canceled the High/Low Alarm and recovery from a power failure with no operation.

Table 4 The situation after being canceled the High/Low Alarm and recovery from a power failure with no operation

Canceled alarm	LCD touch panel		Buzzer	Remote alarm	Safety operation
	Message display field	Alarm display			
High Alarm Low Alarm	—	“Alarm” is displayed alternately in normal characters and reverse video	Intermittent tone	—	—
Power failure alarm	—	“Alarm” is displayed alternately in normal characters and reverse video	Intermittent tone	—	—

Note: By pressing Buzzer key, the alarm display returns to “Normal” and buzzer stops.

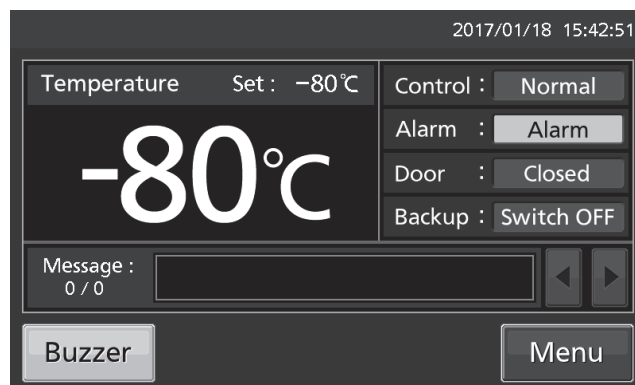

ROUTINE MAINTENANCE

Cleaning the exterior, interior, and accessories

Use a dry cloth to wipe down the outside and inside of the unit and all accessories. If the outside panels are dirty, clean them with a diluted neutral dish-washing detergent.

Wipe off condensation from the exterior of the cabinet with a dry, soft cloth.

◇ Using an undiluted solution of detergent may cause the unit's plastic areas to crack. Follow the directions on the detergent for details of dilution.

◇ After the wiping the cabinet or accessories with a diluted detergent, be absolutely sure to wipe the surfaces with a cloth dipped in clean water to remove traces of the detergent. After this, be absolutely sure to wipe the surfaces with a dry cloth.

<Important>

- Do not use a brush, an acid, a thinner, laundry soap, a powder detergent, or boiling water for cleaning. These may cause damage to painted surfaces or cause perishing of plastic and rubber components. Moreover, do not wipe plastic and rubber components with a volatile material.
- In order to maintain the unit's intended level of performance, always replace accessories that have been removed for cleaning.

Cleaning of air intake port (Manual)

Using the cap for air vent is likely to build a frost in/around the air intake port. Clean it in the case shown below.

Condition	Check / Remedy
When frost and ice can be seen in the air intake port.	The pipe of the air intake port is thrust with a stick for air intake port cleaning of the accessories, and frost is taken.
The outer door does not open even if the cap of the air intake port is opened.	The pipe of the air intake port is thrust with a stick for air intake port cleaning of the accessories, and frost is taken.
Frost and ice can be seen in the chamber.	Frost and ice inside the chamber are taken with scraper of the accessories.



WARNING

For removing the frost in the air intake port, do not use a tool with sharp edge such as a knife or a screw driver.

ROUTINE MAINTENANCE

Defrosting of chamber

Frost may accumulate near the top of the chamber, near the door in the chamber, or near the air intake port (Auto). Excessive accumulation of frost is likely to create gaps between the door and the door gasket, which can reduce the cooling performance. Remove the frost from the chamber and the inner door with the scraper enclosed with the unit. Use the following procedure for defrosting when excessive frost builds up in the chamber.

Note:

Do not use tool with a sharp edge (such as a knife or screw-driver) to remove the frost.

1. Turn off the switch for the back-up cooling kit (if installed).
2. Take out all contents from the freezer and transfer them to another freezer or a container which is refrigerated by liquid carbon dioxide or dry ice.
3. Turn off the power switch and battery switch of the freezer.
4. Open the outer door and inner door. Remove the inner door by lifting up as shown in the figure.
5. Leave the freezer in this state until the frost in the chamber melts.
6. Wipe up the water that accumulates at the bottom of the chamber with a dry cloth.
7. After cleaning the chamber, replace the inner door and start up the unit according to the procedure on page 19.
8. Check that the chamber temperature reaches the set temperature and then replace the contents.
9. Turn on the switch for the back-up cooling kit (if installed).

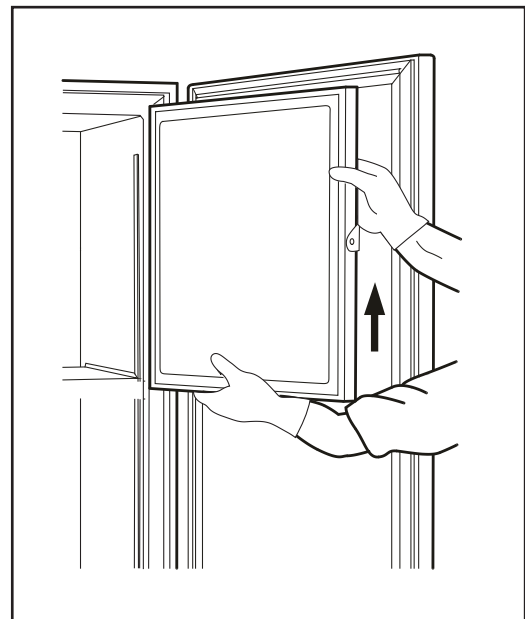

⚠ WARNING

Always wear gloves when mounting and/or removing the inner door to prevent injury.

CALIBRATION

During continuous operation, the following service tasks must be performed:

- Perform a temperature calibration at least once a year.

For temperature calibration, contact our sales representative or agent.

REPLACEMENT OF WORN-OUT PARTS

Replacing the battery for power failure alarm

Replace the battery for power failure alarm about every 3 years. Contact our sales representative or agent for the replacement of battery when “S18: Exchange a Main Battery.” is displayed in the message display field.

- ✧The replacement of the battery for power failure alarm is a paid service.
- ✧The alarm function (message display, sound of buzzer and remote alarm) will not operate when the battery for power failure alarm is flat.
- ✧“W01: Power Failure.” is displayed and the buzzer sounds by the battery for power failure alarm.



WARNING

The replacement of the battery for power failure alarm should be executed by a qualified engineer or service personnel only. ➤ The replacement of the battery for power failure alarm involves the risk of electric shock.

«Important» The used battery is a recyclable resource. Do not dispose of the battery. Always follow the procedure for recycling.

Replacing the battery for backup cooling kit

Replace the battery for backup cooling kit about every 3 years. Contact our sales representative or agent for the replacement of battery when “S19: Exchange a Backup Battery.” is displayed in the message display field.

- ✧The replacement of the battery for backup cooling kit is a paid service.
- ✧The backup cooling kit will not operate when the battery for backup cooling kit is flat.
- ✧When the chamber temperature rises, the backup cooling kit is activated by the battery for backup cooling kit even during a power failure. The regular replacement of the battery for backup cooling kit is important to prevent the rise of chamber temperature in the case of unexpected situation.



WARNING

The replacement of the battery for backup cooling kit should be executed by a qualified engineer or service personnel only. ➤ The replacement of the battery for backup cooling kit involves the risk of electric shock.

«Important» The used battery is a recyclable resource. Do not dispose of the battery. Always follow the procedure for recycling.

TROUBLESHOOTING

If the unit malfunctions, check out the following before calling for service.

<Attention>

If the malfunction is not resolved after checking the following items or if the malfunction is not shown in the table below, contact our sales representative or agent.

Malfunction	Check/Remedy
Nothing operates even when the power supply plug is plugged in	<ul style="list-style-type: none"> <input type="checkbox"/> The unit is not connected to the power supply properly. <input type="checkbox"/> The capacity and voltage of the power supply is not sufficient. <input type="checkbox"/> There is a power failure. <input type="checkbox"/> The circuit breaker on the supply circuit is activated. <input type="checkbox"/> The fuse on the supply circuit is blown.
The compressor does not operate at all when turning ON the power switch. (LCD touch panel is turned ON)	<ul style="list-style-type: none"> <input type="checkbox"/> The capacity of power supply is not sufficient. When the capacity of power supply is not sufficient to start the compressor, compressor may not start.
The alarm is activated during operation	<ul style="list-style-type: none"> <input type="checkbox"/> The chamber temperature setting has been changed. <input type="checkbox"/> The door has been kept open for a long time. <input type="checkbox"/> Containers with a high temperature (load) have been put in the chamber.
Excessive noise	<ul style="list-style-type: none"> <input type="checkbox"/> The floor is not stable. <input type="checkbox"/> The installation site is not level. <input type="checkbox"/> The freezer is tilted. <input type="checkbox"/> The cabinet is touching the surrounding wall.
The chamber does not get cold enough	<ul style="list-style-type: none"> <input type="checkbox"/> Warm material has been put in the chamber. <input type="checkbox"/> The door is frequently opened. <input type="checkbox"/> The set value of the chamber temperature is lower than -86 °C. The temperature settable range is between -90 °C~-50 °C. However, the temperature control range is between -86 °C~-50 °C. <input type="checkbox"/> The unit is in direct sunlight. <input type="checkbox"/> The ventilation around the unit is blocked. <input type="checkbox"/> There is a nearby heat source. <input type="checkbox"/> The ambient temperature is too high. <input type="checkbox"/> There are too many items stored inside the chamber. <input type="checkbox"/> The access port is not covered. <ul style="list-style-type: none"> → The access port should be covered with insulation and rubber caps when not in use. <input type="checkbox"/> The door seal is damaged. <ul style="list-style-type: none"> → If it is damaged, contact our sales representative or agent for replacement. <input type="checkbox"/> A foreign substance is located between door gaskets.
The outside of the unit is wet with dew.	<p>In case of sultriness or bad location, the exterior of the unit may be wet with dew. Under a high humidity environment, the cold exterior of the unit condenses the moisture in the air, so that it is not malfunction. Wipe the dew with a dry cloth.</p>
Noisy in motor sound or flowing liquid.	<p>On the characteristics of the cooling circuit, the sound of motor or flowing refrigerant may be heard during operation. Especially a few hours after starting operation, the sound of compressor or flowing refrigerant may be loud, however it is a normal operation.</p>

Note:

- Keep an electric product which emits an electromagnetic wave away from this unit. A noise from an electromagnetic wave may cause malfunction to this unit.

DISPOSAL OF UNIT

Before disposing the unit with biohazardous danger, decontaminate the unit to the extent possible by the user.

WARNING

If the unit is to be stored unused in an unsupervised area for an extended period **ensure that children do not have access and doors cannot be closed completely.**

The disposal of the unit should be accomplished by appropriate personnel. Always remove doors to prevent accidents such as suffocation.

Recycle of battery

(Only for USA and CANADA)

A sealed lead acid battery that is recyclable powers the product you have purchased. At the end of its useful life, under various state and local laws, it is illegal to dispose of this battery into your municipal waste stream. Please call 1-800-SAV-LEAD for information on how to recycle this battery.

L'appareil que vous vous êtes procuré est alimenté par une batterie au plomb étanche. Après la fin de la vie utile de la batterie, en vertu de diverses réglementations gouvernementales et locales, il est illégal de l'éliminer avec les déchets domestiques ordinaires. Pour des renseignements sur le recyclage de la batterie, veuillez composer le 1-800-SAV-LEAD.



Pb

- USE THE SPECIFIED CHARGER.



- Label indication is obliged to comply with Taiwanese battery regulation.

(Apenas para a Brasil)



CHUMBO

Baterias de chumbo – ácido:

Atenção sobre a bateria:

- Após o uso, a bateria deverá ser devolvida à rede de assistência técnica ou revendedores para ser encaminhada ao fabricante ou importador. (Resolução CONAMA ns° 401)
- **Riscos a saúde:** O contato com os componentes químicos internos desta bateria pode causar danos a saúde.
- **Riscos ao meio-ambiente:** A destinação final inadequada pode poluir águas e solo.
- **Composição básica:** Chumbo, ácido sulfúrico diluído e plástico.

OPTIONAL COMPONENTS

Temperature recorder

The chamber temperature can be recorded and checked by installing an optional temperature recorder MTR-85H or MTR-G85C.

✧Contact our sales representative or agent for the purchase of temperature recorder.

Main specifications of temperature recorder

	MTR-85H	MTR-G85C
Recording range	-100 °C~+50 °C	-100 °C~+40 °C
Feed speed of recording paper	2-month/batch	1-day/1 turn, 7-day/1 turn 32-day/1 turn changeable
Recording paper	Strip type	Circular type
Power source	Dry cell	Supplied from the unit

✧For the installation of temperature recorder MTR-85H, an optional recorder fixing MDF-S3085 and recorder sensor cover MTR-DU700SF is necessary.

✧For the installation of temperature recorder MTR-G85C, an optional recorder sensor cover MTR-DU700SF is necessary.

Small inner doors

For MDF-DU502VX, small inner doors (MDF-5ID4 (4 doors), MDF-5ID5 (5 doors)) are available as an optional component.

For MDF-DU702VX, small inner doors (MDF-7ID4 (4 doors), MDF-7ID5 (5 doors)) are available as an optional component.

For the installation, contact our sales representative or agent.

Note:

✧The cooling performance stated on page 58 cannot be guaranteed when the small inner doors are installed.

Cooling performance : -82 °C at the center of the chamber (ambient temperature; 30 °C, no load)

✧For stable long-term use, we recommend setting it to + 5 °C degrees from the minimum attained temperature.

✧If you attach the small inner doors (MDF-5ID5, MDF-7ID5), you can not use the inventory racks (IR-224U, IR-316U).

Inventory rack

Optional inventory racks (IR-224U, IR-316U) are useful to store important items in the chamber effectively. When these racks are used, it is necessary to change the location of the shelves.

✧Contact our sales representative or agent to arrange purchase of an inventory rack.

OPTIONAL COMPONENTS

Back-up cooling kit

By installing an optional backup cooling kit MDF-UB7 and a liquid CO₂ cylinder, liquid CO₂ injection into the chamber prevent to rise the chamber temperature for a few hours, even when this unit stops operation by a power failure and so on.

↔Contact our sales representative or agent for the purchase of backup cooling kit.

WARNING

As with any equipment that uses CO₂ gas, there is a likelihood of oxygen depletion in the vicinity of the equipment. It is important that you assess the work site to ensure there is suitable and sufficient ventilation. If restricted ventilation is suspected, then other methods of ensuring a safe environment must be considered. These may include atmosphere monitoring and warning devices.

The injection set temperature of the backup cooling kit can be set by the temperature setting knob [page 12]. Since the control method of injection is ON/OFF type, the actual injection temperature deviates from the injection set temperature.

Note:

- Set the injection set temperature of the backup cooling kit to 10 °C higher than the set temperature. Otherwise, continuous injection of liquid CO₂ may reduce the retention time of liquid CO₂ cylinder.
- When the injection set temperature of the backup cooling kit is -70 °C;
ON: -67 °C~-65 °C, OFF: -75 °C~-74 °C.

The behavior of the backup cooling kit

Backup power switch [Page 12]	Backup display [Page 13]	Condition of the backup cooling kit	Chamber temperature	Liquid CO ₂
ON	Switch ON	Ready to inject	Less than the injection set temperature of the backup cooling kit.	Does not inject
			The injection set temperature of the backup cooling kit or higher.	Injects
OFF	Switch OFF	Not ready to inject (Not ready to activate the backup test switch)	Less than the injection set temperature of the backup cooling kit.	Does not inject
			The injection set temperature of the backup cooling kit or higher.	

- Duration of backup cooling:
MDF-DU502VXC:Approx. 10 hours, MDF-DU702VXC:Approx. 9 hours,
(ambient temp.; 30 °C, set temp.; -70 °C, no load, liquid CO₂ gas cylinder of 30 kg)

SPECIFICATIONS

Product name	Ultra-Low Temperature Freezer MDF-DU502VXC	Ultra-Low Temperature Freezer MDF-DU702VXC
External dimensions	W790 mm x D882 mm x H1993 mm	W1030 mm x D882 mm x H1993 mm
Internal dimensions	W630 mm x D600 mm x H1400 mm	W870 mm x D600 mm x H1400 mm
Effective capacity	528 L	729 L
Exterior	Painted steel	
Interior	Painted steel	
Outer door	Painted steel	
Inner door	2 doors	
Shelf	Stainless steel, 3 shelves (adjustable) Inner dimension; W615 mm x D534 mm Load; 50 kg/shelf	Stainless steel, 3 shelves (adjustable) Inner dimension; W855 mm x D534 mm Load; 50 kg/shelf
Access port	Inner diameter: 17 mm, 3 locations (back x 1, bottom x 2)	
Insulation	Rigid polyurethane foamed-in place + Vacuum insulation panel	
Compressor	A compressor; Output; 1100 W B compressor; Output; 1100 W	
Evaporator	(Both A and B) Tube on sheet type	
Condenser	(Both A and B) Finless tube type	
Refrigerant	(Both A and B) HFC mixed refrigerant	
Temperature controller	Microcomputer control system	
Temperature display	LCD Digital display	
Thermal sensor	Platinum resistance (Pt 1000 Ω)	
Alarm	High Alarm, Low Alarm, Power failure alarm, Door alarm, Remote alarm	
Remote alarm contact	Allowable contact capacity: DC 30 V, 2 A *1	
Battery	Lead storage battery, DC 6 V, 7200 mAh, Auto-recharge	
Weight	294 kg	338 kg
Voltage booster	Built-in	
Accessories	1 set of key, 1 scraper, 1 stick for air intake port cleaning	
Optional component	Temperature recorder (MTR-85H, MTR-G85C) Recorder fixing (MDF-S3085; MTR-85H) Recorder sensor cover (MTR-DU700SF) Backup cooling kit (MDF-UB7); For Liquid CO ₂	
	Small inner door (MDF-5ID4, MDF-5ID5)	Small inner door (MDF-7ID4, MDF-7ID5)
	Drawers (MDF-50R)	—
	Storage rack (MDF-70SC) Inventory rack (IR-224U, IR-316U) Interface board (MTR-L03) *1, *2; For LAN Interface board (MTR-480) *1, *2; For RS-232C/RS-485	

*1: It is recommended to use standard signal and interface cables with a maximum length of 30 meters.

*2: For the data acquisition system MTR-5000 user only. Contact our sales representative or agent for purchase.

Note:

- Design or specifications are subject to change without notice.
- Refer to the updated catalogue when ordering an optional component.

PERFORMANCE

Product name	Ultra-Low Temperature Freezer MDF-DU502VXC	Ultra-Low Temperature Freezer MDF-DU702VXC
Model number	MDF-DU502VXC-PA	MDF-DU702VXC-PA
Cooling performance	-86 °C at the center of the chamber (ambient temperature; 30 °C, no load)*	
Temperature settable range	-90 °C to -50 °C	
Temperature control range	-86 °C to -50 °C (ambient temperature; 30 °C, no load)	
Rated voltage	AC 220 V	
Rated frequency	60 Hz	
Rated power consumption	1310 W (Max.1750 W)	1290 W (Max.1670 W)
Noise level	52 dB [A] (background noise; 20 dB)	
Maximum pressure	3100 kPa	3280 kPa
Usable environment condition	Temperature; 5 °C to 30 °C Humidity; equal or less than 80 %R.H.	

* Maximum cooling performance.

The chamber temperature can be reached at -86 °C at ambient temperature 30 °C with no load.

PHC Corporation

1-1-1 Sakada, Oizumi-machi, Ora-gun, Gunma 370-0596, Japan

© PHC Corporation 2018

Printed in Japan
LDCL045700-0
S0418-0