

PHCbi

Operating Instructions

CO₂ Incubator

MCO-80ICL



For Research Use Only.

This product is for research use only.

Not for clinical diagnosis or treatment of humans or animals.

Please read the operating instructions carefully before using this product, and keep the operating instructions for future use.

See page 39 for model number.

CONTENTS

INTRODUCTION	2
PRECAUTIONS FOR SAFE OPERATION	3
LABELS ON UNIT.....	7
ENVIRONMENTAL CONDITIONS	8
INCUBATOR COMPONENTS.....	9
Control panel and keypad	12
Remote alarm terminal.....	14
INSTALLATION SITE	15
INSTALLATION	16
Connection of CO ₂ gas cylinder	17
CAUTIONS FOR USING EQUIPMENT IN CHAMBER	18
PREVENT CONTAMINATION.....	19
CAUTIONS FOR CULTURE.....	20
START-UP OF UNIT.....	21
SETTING OF CHAMBER TEMPERATURE AND CO ₂ DENSITY	22
KEY LOCK FUNCTION	25
ALARMS & SAFETY FUNCTIONS.....	26
SETTING OF ALARM RESUME TIME.....	28
Operation after power failure.....	28
ROUTINE MAINTENANCE	29
Sterilizing of chamber and attachments.....	29
Filling water reservoir	31
CALIBRATION	
Temperature calibration	32
CO ₂ calibration	33
TROUBLESHOOTING.....	34
DISPOSAL OF UNIT.....	35
AUTOMATIC CO ₂ CYLINDER CHANGEOVER.....	36
AUTO WATER SUPPLY SYSTEM.....	37
SPECIFICATIONS	38
PERFORMANCE	39
SAFETY CHECK SHEET	40

INTRODUCTION

- Read the operating instructions carefully before using the Product and follow the instructions for safety operation.
- PHC Corporation disavows any responsibility for safety if the Product is used for other than the intended use or used with any procedures other than those given in the operating instructions.
- Keep the operating instructions in a suitable place so that it can be referred to as necessary.
- The contents of the operating instructions are subject to change without notice for improvement of performance or functions.
- Contact our sales representative or agent if any page of the operating instructions is lost or the page order is incorrect.
- Contact our sales representative or agent if any point in the operating instructions is unclear or if there are any inaccuracies.
- No part of the operating instructions may be reproduced in any form without the expressed written permission of PHC Corporation.

IMPORTANT NOTICE

PHC Corporation guarantees this product under certain warranty conditions. However, please note that PHC Corporation shall not be responsible for any loss or damage to the contents of the product.

<Intended Use>

This equipment is designed for cell and tissue culture for laboratory use.

PRECAUTIONS FOR SAFE OPERATION

It is imperative that the user complies with the operating instructions as it contains important safety advice.

Items and procedures are described so that you can use this unit correctly and safely. If the precautions advised are followed, this will prevent possible injury to the user and any other person.

Precautions are illustrated in the following way:



WARNING

Failure to observe WARNING signs could result in a hazard to personnel possibly resulting in serious injury or death.

CAUTION

Failure to observe CAUTION signs could result in injury to personnel and damage to the unit and associated property.

Symbol shows;

-  This symbol means caution.
-  This symbol means an action is prohibited.
-  This symbol means an instruction must be followed.

Be sure to keep the operating instructions in a place accessible to users of this unit.

WARNING

As with any equipment that uses CO₂ gas, there is a likelihood of oxygen depletion in the vicinity of the equipment. It is important that you assess the work site to ensure there is suitable and sufficient ventilation. If restricted ventilation is suspected, then other methods of ensuring a safe environment must be considered. These may include atmosphere monitoring and warning devices.

PRECAUTIONS FOR SAFE OPERATION

USA Only (Model with a lamp): This product has a lamp that contains mercury. Disposal may be regulated in your community due to environmental considerations. For disposal or information, please visit PHC website: <https://www.phchd.com>.

Contains mercury / Contenu avec mercure

For more information on safe handling procedures, the measures to be taken in case of accidental breakage and safe disposal options visit:

ec.gc.ca/mercure-mercury/.















Dispose of or recycle in accordance with applicable laws.

Pour plus de renseignements sur les procédures de manutention sécuritaire, les mesures à prendre en cas de bris accidentel et les options d'élimination sécuritaire visitez:

ec.gc.ca/mercure-mercury/.







Mettez au rebut ou recyclez conformément aux lois applicables.

WARNING







-  **Do not use the unit outdoors.** Current leakage or electric shock may result if the unit is exposed to rain water.
-  **Only qualified engineers or service personnel should install the unit.** The installation by unqualified personnel may cause electric shock or fire.
-  **Install the unit on a sturdy floor and take an adequate precaution to prevent the unit from turning over.** If the floor is not strong enough or the installation site is not adequate, this may result in injury from the unit falling or tipping over.
-  **Never install the unit in a humid place or a place where it is likely to be splashed by water.** Deterioration of the insulation may result which could cause current leakage or electric shock.
-  **Never install the unit in a flammable or volatile location.** This may cause explosion or fire.
-  **Never install the unit where acid or corrosive gases are present** as current leakage or electric shock may result due to corrosion.
-  **Always ground (earth) the unit to prevent electric shock.** If the power supply outlet is not grounded, it will be necessary to install a ground by qualified engineers.
-  **Never ground the unit through a gas pipe, water main, telephone line or lightning rod.** Such grounding may cause electric shock in the case of an incomplete circuit.
-  **Connect the unit to a power source as indicated on the rating label attached to the unit.** Use of any other voltage or frequency other than that on the rating label may cause fire or electric shock.
-  **Never store volatile or flammable substances** in this unit if the container cannot be sealed. These may cause explosion or fire.
-  **Do not insert metal objects such as a pin or a wire into any vent, gap or any outlet on the unit.** This may cause electric shock or injury by accidental contact with moving parts.
-  **Use this unit in safe area when treating the poison, harmful or radiate articles.** Improper use may cause bad effect on your health or environment.
-  **Turn off the power switch (if provided) and disconnect the power supply to the unit prior to any repair or maintenance** of the unit in order to prevent electric shock or injury.
-  **Do not touch any electrical parts (such as power supply plug) or operate switches with a wet hand.** This may cause electric shock.

PRECAUTIONS FOR SAFE OPERATION

WARNING





-  **Ensure you do not inhale or consume medication or aerosols** from around the unit at the time of maintenance. These may be harmful to your health.
-  **Never splash water directly onto the unit** as this may cause electric shock or short circuit.
-  **Never put containers with liquid on the unit** as this may cause electric shock or short circuit when the liquid is spilled.
-  **Never bind, process, or step on the power supply cord, or never damage or break the power supply plug.** A broken power supply cord or plug may cause fire or electric shock.
-  **Do not use the power supply cord if its power supply plug is loose.** Such power supply cord may cause fire or electric shock.
-  **Never disassemble, repair, or modify the unit yourself.** Any such work carried out by an unauthorized person may result in fire, or electric shock or injury due to a malfunction.
-  **Disconnect the power supply plug if there is something wrong with the unit.** Continued abnormal operation may cause electric shock or fire.
-  **When removing the power supply plug from the power supply outlet, grip the power supply plug,** not the cord. Pulling the cord may result in electric shock or fire by short circuit.
-  **Disconnect the power supply plug** before moving the unit. Take care not to damage the power supply cord. A damaged cord may cause electric shock or fire.
-  **Disconnect the power supply plug when the unit is not used for long periods.** Keeping the connection may cause electric shock, current leakage, or fire due to the deterioration of insulation.
-  **If the unit is to be stored unused in an unsupervised area for an extended period, ensure that children do not have access and that doors cannot be closed completely.**
-  **The disposal of the unit should be accomplished by appropriate personnel.** Remove doors to prevent accidents such as suffocation.
-  **Do not put the packing plastic bag within reach of children** as suffocation may result.
-  **Do not position this unit and the other unit so that it is difficult to operate the disconnection of the power supply plug.** Failure to disconnect the power supply plug may cause fire if there is something wrong with the unit.

CAUTION

-  This unit must be plugged into a dedicated circuit protected by branch circuit breaker.
-  Use a dedicated power source as indicated on the rating label attached to the unit. A multiple-tap may cause fire resulting from abnormal heating.
-  **Never store corrosive substances such as acid or alkali** in this unit if the container cannot be sealed. These may cause corrosion of inner components or electric parts.
-  **Check the setting when starting up of operation after power failure or turning off of power switch.** The stored items may be damaged due to the change of setting.
-  **Be careful not to tip over the unit** during movement to prevent damage or injury.
-  **Prepare a safety check sheet** (copy the last page) when you request any repair or maintenance for the safety of service personnel.

LABELS ON UNIT

Some warning and/or caution labels are attached on the unit. Following shows the description of such labels.

	This label is on the cover in which the electrical components of high voltage are enclosed to prevent the electric shock. The cover should be removed by a qualified engineer or a service personnel only.
	This symbol means UV caution.
	This symbol means attention or refer to document.
	This symbol means hot surface.
	This symbol means earth.
	This symbol means power switch "ON".
○	This symbol means power switch "OFF".

ENVIRONMENTAL CONDITIONS

This equipment is designed to be safe at least under the following conditions (based on the IEC 61010-1):

- Indoor use;
- Altitude up to 1000 m;
- Temperature 5 °C to 40 °C;
- Maximum relative humidity 80 % for temperature up to 31 °C decreasing linearly to 50 % relative humidity at 40 °C;
- Mains supply voltage fluctuations up to ± 10 % of the nominal voltage;
- Transient overvoltages up to the levels of OVERVOLTAGE CATEGORY II;
- Temporary OVERVOLTAGES occurring on the mains supply;
- Applicable pollution degree of the intended environment (POLLUTION DEGREE 2 in most cases);

INCUBATOR COMPONENTS

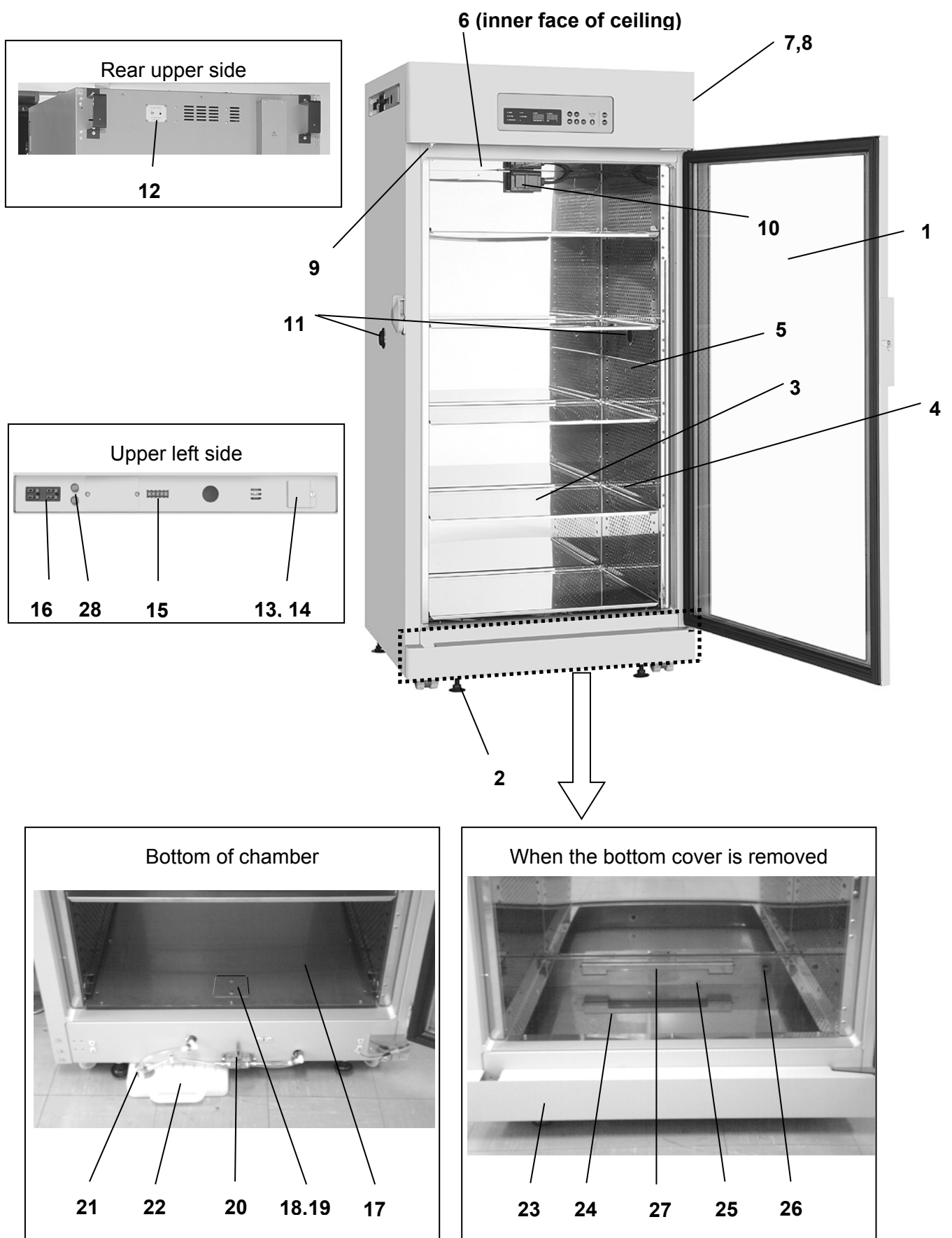

INCUBATOR COMPONENTS

- 1. Outer door:** Sticks to frame with magnetic seal. Door heater is installed in the door panel. The door window is double glass.
- 2. Leveling foot:** Screw type for adjusting the height. Adjust the foot so that the unit can be level.
- 3. Tray:** Can be pulled toward you. Make sure to set the bottom tray to the bottom position of side duct with tray support (This may cause condensation on bottom cover by varying air flow inside chamber).
- 4. Tray support:** Can be removed by lifting the front side and pulling toward you.
- 5. Side duct:** Flow path for circulating air. Removable.
- 6. Fan (behind of ceiling)**
- 7. Sample air outlet:** This also functions as an internal gas outlet. Normally, cover this outlet with the sample air outlet cap.
- 8. Sample air outlet cap:** Always attach this cap except at the time of using of sample air outlet.
- 9. Door switch:** Detects the door opening/closing and stops the circulating fan and electromagnetic valve for CO₂ when door is open. UV lamp is also deactivated by door opening (when an optional UV system set MCO-80UVS is installed).
- 10. Inside power outlet:** AC 115 V and up to 3 A in total. It is possible to use on the condition that inner temperature below 40 °C and humidity below 50%R.H. When humidifying chamber, bottom cover must be placed properly. At the first time to operate, press the reset button between two inside power outlets.
- 11. Access port:** When not in use, cap them with two attached silicon caps on outside.
- 12. Connecting port for CO₂ gas pipe (rear side):** When an optional component MCO-80GC (gas auto changer) is installed, both A and B are available. If MCO-80GC is not used, only A is available. Refer to page 17 for gas cylinder connection. Ensure that the gas pressure is set at 0.1 MPa(G) (1.0 kgf/cm²(G), 14.5 psi(G)). Refer to page 36 for gas auto changer.
- 13. Power switch:** Main switch of the unit (ON-"I", OFF-"O"). Also functions as an over-current breaker.
- 14. Power switch cover:** Power switch is covered by a power switch cover to prevent the accidental push. To turn on or off the switch, remove a power switch cover by loosening the screw.
- 15. Remote alarm terminal:** Refer to page 14.
- 16. Outer power outlet:** AC 115 V, and up to 3 A in total.
- 17. Bottom cover:** Prevents UV light being exposed to the chamber. Lift to remove for cleaning. See page 29 for details.
- 18. Water supply inlet cover:** When filling the water reservoir, remove a screw and rotate the cover.
- 19. Water supply inlet:** Usually closed with water supply inlet cover.
- 20. Drain cock:** Open the drain cock to drain water from the water reservoir.
- 21. Drain outlet:** Insert the drain outlet into the attached drain tank installed under the unit.
- 22. Drain tank**
- 23. Front panel lower cover:** Detach it when draining water from the water reservoir. See to page 29 for details.

24. Water reservoir: Use sterile distilled water of approximately 20 L to fill the water reservoir.

25. Water level sensor for water reservoir: Detects the water level in the water reservoir.

26. Auto water supply inlet: When an optional component MCO-80AS (auto water supply system) is installed, water is supplied from here.

27. UV lamp (option)

28. Fuse: upper: for inside power outlet 125 V, 3.15 A. Normal blow type.

lower: for outer power outlet 125 V, 1 A. Normal blow type.

INCUBATOR COMPONENTS

Control panel and keypad

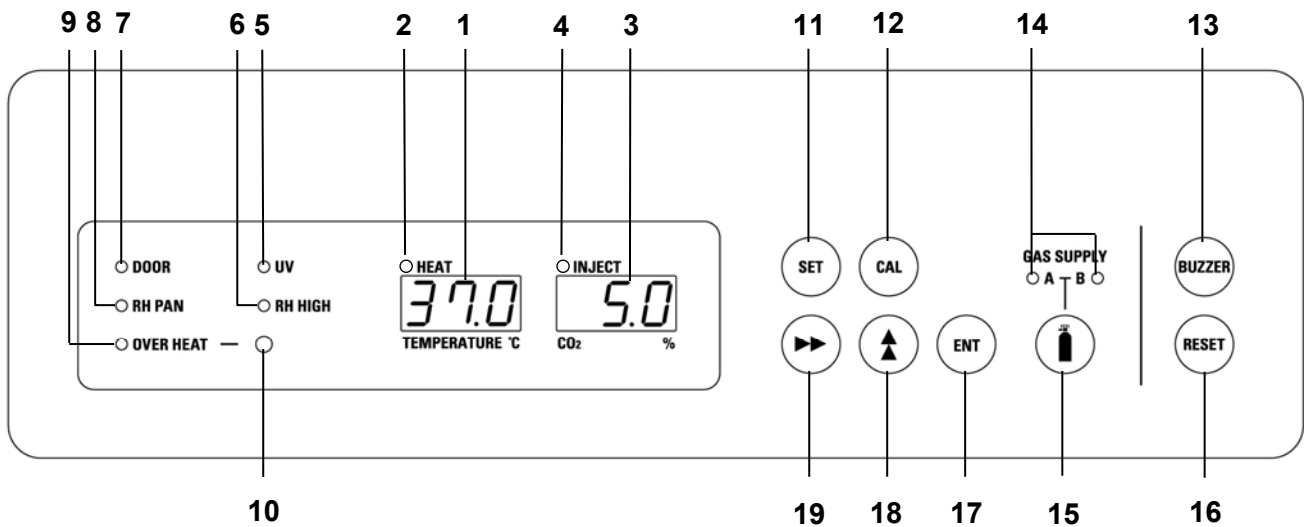

- 1. Digital temperature indicator (TEMPERATURE °C):** Normally, this indicator shows the chamber temperature. In the setting mode, it shows the set value of the chamber temperature. If the self diagnostic function detects any abnormality, an error code will be displayed.
- 2. Heater lamp (HEAT):** This lamp lights when the heater is energized.
- 3. Digital CO₂ density indicator (CO₂ %):** Normally, this indicator shows the CO₂ concentration in the chamber. In the setting mode, it indicates the set value of the CO₂ concentration.
- 4. CO₂ inject lamp (INJECT):** This lamp lights when CO₂ gas is being injected.
- 5. UV indicator (UV):** This lamp lights when the UV lamp is ON [when an optional component MCO-80UVS (UV system set) is installed]. The blink of this indicator recommends the replacement of UV lamp.
- 6. High humidity mode indicator (RH HIGH):** This lamp lights when the high humidity mode is activated. See page 23 for changing to the high humidity mode.
- 7. Door lamp (DOOR):** This lamp lights when the outer door is open.
- 8. Water level alarm lamp (RH PAN):** This lamp blinks when the water in the water reservoir is less than approximately 5 L.
- 9. Over heat lamp (OVER HEAT):** This lamp lights when the chamber temperature reaches the upper limit set value. It starts to blink when the chamber temperature is back in below the upper limit set value.
- 10. Upper limit regulator:** This regulator is used to set the upper temperature limit.
- 11. Set key (SET):** Pressing this key to enter the setting mode, and the digits to be set will blink.
- 12. Calibration key (CAL):** By pressing this key for approximately 5 seconds, the unit enters calibration function mode.
- 13. Alarm buzzer stop key (BUZZER):** Press this key to silence the buzzer when the alarm operates and the buzzer sounds.
- 14. CO₂ gas supply line indicator (A/B):** The lamp for the supply line currently in use lights up provided that MCO-80GC gas auto changer is installed.
- 15. CO₂ gas supply line switching key :** This key to select CO₂ gas supply line is available only when a gas auto changer MCO-80GC (option) is installed. When one CO₂ cylinder is empty, the CO₂ is supplied by the other cylinder automatically.

16. Upper limit alarm reset key (RESET): Press this key while the over heat lamp blinks to reset the alarm.

17. Enter key (ENT): Pressing this key memorizes the set value in the controller.

18. Numerical value shift key (▲): Pressing this key in the setting mode causes the numerical value to shift. In key lock mode, pressing this key makes key lock ON or OFF.

19. Digit shift key (▶▶): Pressing this key in the setting mode causes the changeable digit to shift. Pressing this key more than 5 seconds enters key lock mode. See page 25 for the key lock.

INCUBATOR COMPONENTS

Remote alarm terminal

The remote alarm terminal is located at the upper left side of the unit.

The remote alarm terminal is a contact output.

Normal : Open between COM to N.O.
Close between COM to N.C.

Abnormal: Open between COM to N.C.
Close between COM to N.O.

Contact capacity : DC 30 V, 2 A

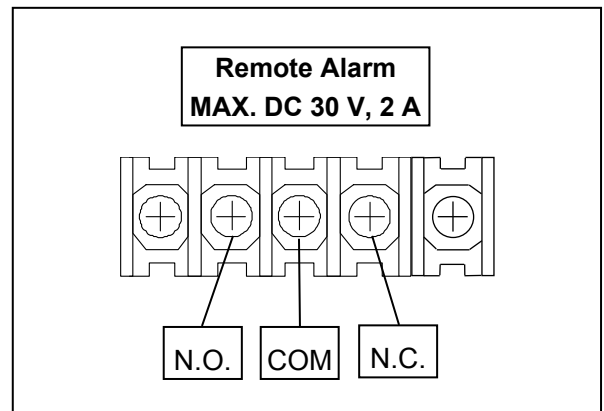

Note:

- When the power switch is OFF or the power failure condition, the contact output between COM to N.O. is CLOSE (the contact output between COM to N.C. is OPEN).
- The remote alarm cannot be silenced by pressing the alarm buzzer stop key (BUZZER) since the remote alarm is not conjunct with the alarm buzzer stop key (BUZZER).

INSTALLATION SITE

To operate this unit properly and to obtain maximum performance, install the unit in a location with the following conditions:

■ **A location not subjected to direct sunlight**

Do not install the unit under direct sunlight. Installation in a location subjected to direct sunlight cannot obtain the intended performance.

■ **A location with clean air and adequate ventilation** (Small and sealed room is not recommended.)

 **WARNING**

Ventilate a room air occasionally when using CO₂ gas for control. The gas density will increase in an enclosed small room and high level of gas density can be hazardous to health. In addition, avoid inhaling the chamber air directly when opening the door if CO₂ gas is used.

Si l'appareil est utilisé dans un endroit restreint, le niveau de la densité CO₂ de l'air peut s'élever et peut être nocif aux humains. Évitez d'aspirer l'air provenant de l'intérieur de l'appareil quand vous ouvrez la porte.

■ **A location away from heat generating sources**

Avoid installing the unit near heat-emitting appliances such as a heater or a boiler etc. Heat can decrease the intended performance of the unit.

■ **A location with a sturdy and level floor**

Always install the unit on a sturdy and level floor. The uneven floor or tilted installation may cause failure or injury. Install the unit in stable condition to avoid the vibration or noise. Unstable condition may cause vibration or noise.

 **WARNING**

Install the unit on a sturdy floor. If the floor is not strong enough or the installation site is not adequate, this may result in injury from the unit falling or tipping over.

Select a level and sturdy floor for installation. This precaution will prevent the unit from tipping. Improper installation may result in water spillage or injury from the unit tipping over.

■ **A location not prone to high humidity**

Install the unit in the ambient of 80% R.H. or less humidity. Installation under high humidity may cause current leakage or electric shock.

 **WARNING**

Do not use the unit outdoors. Current leakage or electric shock may result if the unit is exposed to rain water.

Never install the unit in a humid place or a place where it is likely to be splashed by water. Deterioration of the insulation may result which could cause current leakage or electric shock.

■ **A location without flammable or corrosive gas**

Never install the unit in a flammable or volatile location. This may cause explosion or fire or may result in the current leakage or electric shock by the corrosion of the electrical components.

■ **5°C higher than the ambient temperature**

The chamber temperature must be at least 5 °C higher than the ambient temperature. For example, the chamber temperature is set to 37 °C, the ambient temperature must be less than 32 °C. Keep the ambient temperature in adequate range.

INSTALLATION SITE

■ Altitude up to 1000 m

It is necessary to replace the outer glass door with specific one when the unit is used at an altitude of 1000 m or higher. If the unit needs to be airfreighted, consult with our sales representative or agent.

INSTALLATION

1. Remove the packaging materials and tapes

Remove all transportation packaging materials and tapes. Open the doors and ventilate the unit. If the outside panels are dirty, clean them with a thinned neutral detergent and wipe it up with a wet cloth.

Note:

Remove the cable tie banding the power supply cord. Prolonged banding may cause the corrosion of the cord coating.

2. Adjust the leveling feet

Extend the leveling feet by rotating them counterclockwise to contact them to the floor. Ensure the unit is level.

3. Fix the unit

Two fixtures are attached to the rear of the frame. Fix the frame to the wall with these hooks and rope or chain.

4. Ground (earth)

WARNING

Use a power supply outlet with ground (earth) to prevent electric shock. If the power supply outlet is not grounded, it is necessary to install a ground by qualified engineers.

Never ground the unit through a gas pipe, water main, telephone line or lightning rod. Such grounding may cause electric shock in the case of an incomplete circuit.

● **If not used**

When the unit is not used, drain the water in the water reservoir and remove any moisture in the chamber completely. Check that the chamber is completely dry before closing the door.

● **Before moving the unit**

Empty the water reservoir completely before moving the unit. Spilled or splashed water may cause current leakage or electric shock.

Connection of CO₂ gas cylinder

WARNING

Check the gas type and ensure that it is fit for the purpose. Make sure that all pipes are connected correctly and are not liable to become disconnected. Ensure that the gas pressure is set at the specified value. Improper connection of the gas pipe or use of incorrect gas pressure may result in leakage of CO₂ gas. Elevated level of CO₂ gas can be hazardous to health and may lead to asphyxiation and risk of death.

Use a liquefied CO₂ gas cylinder, not a siphon (dip tube) type. The CO₂ gas should be 99.5 % or more pure.

1. Use a gas regulator rated at 25 MPa(G) (250 kgf/cm²(G), 3600 psi(G)) on the primary side and 0.2 MPa(G) (2.0 kgf/cm²(G), 30 psi(G)) on the secondary side with flow rate of 77 L/min.
2. Using the gas supply pipe provided, connect the gas regulator to the connecting port for CO₂ gas pipe located at the rear upper side of the CO₂ incubator.
3. Set the CO₂ pressure on the secondary side to 0.1 MPa(G) (1.0 kgf/cm²(G), 14.5 psi(G)) (at gas injection). Excessive pressure may cause disconnection of internal pipes inside the CO₂ incubator which will result in leakage of CO₂ gas into the atmosphere. Elevated level of CO₂ gas can be hazardous to health and may lead to asphyxiation and risk of death. The repair of the incubator will be necessary if the internal pipe is disconnected.
4. Check that no gas is leaking at any point where the pipe connects with the gas regulator or the CO₂ incubator.

Note:

- Refer to “Procedure for replacement of gas cylinder” enclosed with the unit at the time of replacement.
- The incubator, including the gas supply pipes and services must be examined at frequent intervals to ensure they are safe. Ensure that items such as pipes are replaced if there is any sign of deterioration.

CAUTIONS FOR USING EQUIPMENT IN CHAMBER

- **Use the inner outlet for an equipment used in the chamber**

For power source of a heat emitting equipment used in the chamber such as a shaker or a bottle roller, use the electrical outlet equipped in the product. In case of that the chamber temperature rises too much due to this heat emission, when it reaches the preset temperature of over heating protection, electricity through the outlet is cut automatically to avoid over heating in the chamber. For this reason, avoid using equipment in the chamber that take power source from any other than the outlet equipped in the product, since it may be dangerous.

- **If there is too much heat emission from the equipment in the chamber**

The chamber temperature may deviate very much from the setting temperature when a heat generator (heater, motor, etc.) of the equipment is energized in the chamber.

- **When operating an equipment in the chamber, use at "No humidifying mode" (refer to page 23).**

High humidity may cause a failure, a current leakage or a fire to an equipment in the chamber.

- **When operating an equipment in the chamber, make sure there is no water in the water reservoir.**

PREVENT CONTAMINATION

To prevent contamination of the chamber, select an appropriate location for installation as well as the complete disinfection of the chamber components.

- **Avoid hot and humid location**

Avoid location with high temperature and/or humidity as the presence of bacteria in the air is greater than in normal environment.

- **Avoid drafty location and location with many passers-by**

Avoid locations near doors, air conditioners, fans, etc., where slight breezes can facilitate the entry of bacteria into the chamber.

- **Installation in a sterile room**

To get the cultivation more efficiently, install the unit in a sterile room.

- **Use clean containers**

The contamination is mainly caused by the containers such as Petri dishes or bottles stored in the chamber. Always keep the containers clean.

- **Always keep the chamber clean**

The condensation may be caused on the inside of the door by spilled water from water reservoir or opening of outer door for long period. Wipe off the condensation completely with a sterile dry gauze. Especially when the culture medium is spilled, clean and disinfect the chamber immediately. Refer to page 29 "Routine maintenance" for details.

- **Keep the inside panels dry**

To protect the inside of the unit from contamination, the inside panels should always be kept dry. If water is spilled from a water reservoir or if the door is kept open for a long period, condensation will form on the panels, allowing germs to breed. In such a case, wipe away the water with a dry sterile gauze. Particularly, if the medium is spilled, wipe it up immediately and sterilize the area.

- **Fill the water reservoir with sterile distilled water**

Always use sterile distilled water of approximately 20 L to fill the water reservoir. The water level alarm lamp (RH PAN) on the control panel blinks when the amount of water is less than approximately 5 L. Refill the sterile distilled water to the water reservoir when the water level alarm lamp (RH PAN) blinks. Note that when low temperature water is poured, the chamber temperature drops significantly. Clean the water reservoir once a month.

- **Do not place the unit in the direct air flow from an air conditioning system**

Cool air from an air conditioning system may cause condensation and lead to possible contamination.

CAUTIONS FOR CULTURE

- **Do not subject to direct air flow**

Do not allow the air for air conditioning to hit the unit or door directly. Direct hit may cause condensation or contamination.

- **Tray**

Make sure to set the bottom tray to the bottom position of side duct with tray support. This may cause condensation on bottom cover by varying air flow inside chamber.

- **Do not block holes on the side duct with the culture vessels.**

When storing cultures in the chamber, take care not to block holes on the side duct with the Petri dishes or roller-bottle racks to allow adequate air circulation. Blockage of holes may result in uneven temperature distribution and CO₂ concentration in the chamber.

- **Stored materials**

Never place acid or alkaline materials or materials that release corrosive gas in the chamber. Such materials can cause failure resulting from discoloration or corrosion.

- **Open/close the doors gently**

Ensure you close the doors gently. Robust closing may cause spillage of medium, incomplete closing, or damage of gasket.

- **Fix the tray supports and trays securely**

Incomplete installation may cause injury or damage.

- **Never lean or press on the glass.**

Intentional force may cause injury if the glass breaks.

- **Do not lean on the door**

This may cause injury, current leakage, or electric shock if the unit tips over or door drops out.

- **Alarm**

Always investigate the cause and fix the alarm condition immediately when the alarm is activated. Refer to page 26 for alarm details.

START-UP OF UNIT

When start the test operation or the operation, follow these steps as below.

1. Install the unit referring to “INSTALLATION” on page 16.
2. Remove all transportation packaging materials and tapes. Then clean and sterilize the chamber and internal attachments. Refer to “Sterilizing of chamber and attachment” on page 29.
3. Place the drain tank under the unit. Insert a drain outlet into the hole of drain tank.
4. Fill the water reservoir with sterile distilled water of about 20 L. (Refer to page 31)
5. Turn on the power switch located on the upper left side of the unit.

CAUTION

Do not put the packing plastic bag within reach of children as suffocation may result.



SETTING OF CHAMBER TEMPERATURE AND CO₂ DENSITY

Table below shows the basic procedure for setting the chamber temperature and CO₂ density. The upper limit alarm temperature setting is also shown in the table. Perform key operations in the sequence indicated in the table. The example in the table is based on the assumption that the desired temperature is 37 °C and CO₂ density is 5 %. Adjustment of the upper limit regulator should be executed after the chamber temperature reaches the stable condition.

Note: The unit is set at the factory so that the chamber temperature is 37 °C and CO₂ control is 0 %.

Allow at least 4 hours until the next setting after setting of desired chamber temperature and setting CO₂ density to 0 %, at the time of first start-up or start-up after no use for long term.

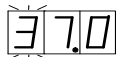
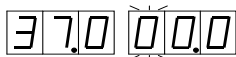
Basic operation sequence (Example: Chamber temperature; 37 °C, CO₂ density; 5 %)

	Description of operation	Key operated	Indication after operation
1	Turn the power switch ON.	----	The current chamber temperature is displayed in temperature indicator.
2	Press set key.	SET	The left digit blinks. 
3	By pressing digit shift key and numerical value shift key, set the figure to 37.0.	▶▶	When pressed, the changeable digit is shifted.
		▲	When pressed, the figure of settable digit changes.
4	Press enter key.	ENT	Set temperature is memorized. Left digit in digital CO ₂ density indicator blinks. 
5	By pressing digit shift key and numerical value shift key, set the figure to 05.0.	▶▶	When pressed, the changeable digit is shifted.
		▲	When pressed, the figure of settable digit changes. 
6	Press enter key.	ENT	Set CO ₂ density is memorized.
7	(Executed after the chamber temperature reaches the stable condition) Adjust upper limit regulator so that the alarm temp. is 1 °C higher than chamber temperature.		In digital CO ₂ density indicator, HI is displayed. In digital temperature indicator, upper limit temp. is displayed. The upper limit temp. can be changed by turning upper limit regulator.
8	Press enter key.	ENT	This is the end of set mode and the indicators display current temperature and CO ₂ density.

Note:

- In each set mode, if the change of the setting is not necessary, pressing set key (SET) skips to next set mode.
- When the CO₂ density is set to 00.0, the control is OFF regardless of chamber density.
- The upper limit temperature set value will change when the regulator is turned even if the unit is not in set mode, because the alarm circuit is an independent circuit.
- In each set mode, the indicator returns to the current temperature and CO₂ density display mode automatically when 90 seconds has passed without any key operation.
- Do not use Calibration key (CAL) on the control panel under normal conditions. Pressing calibration key (CAL) leads the calibration mode. Incorrect operation may cause interferences in the basic functions of the unit. When the calibration mode is activated by mistake, remain untouched any keys for 90 seconds to automatically restore the current value indication mode.

This product usually operates in approximately 80 %R.H. setting. For approximately 90 %R.H. operation, the high humidity mode needs to be set (the normal mode is set as default setting at the factory). Table.1 shows the procedure to set the high humidity mode. Table.2 shows the procedure to set of the no humidifying mode which doesn't humidify at all.

F26	Mode	Function
000	No humidifying mode	No humidifying
001	Normal mode	Inner humidity 80 %R.H.
002	High humidity mode	Inner humidity 90 %R.H.

Table.1 High humidity mode setting procedure

	Description of operation	Key operated	Indication after operation
1		-----	The current chamber temperature is displayed.
2	Press calibration key for 5 seconds.	CAL	The left digit on the digital temperature display blinks.
3	By pressing digit shift key and numerical value key, set the figure to F26.		When pressed, the settable digit is shifted.
			When pressed, the figure of settable digit changes.
4	Press enter key.	ENT	The current set value is displayed in digital CO ₂ density indicator. The right digit blinks.
5	By pressing numerical value key, set the value to 002.		When pressed, the figure of the right digit changes.
6	Press enter key.	ENT	Set value is memorized. The current chamber temperature is displayed.

Table.2 No humidifying mode setting procedure

	Description of operation	Key operated	Indication after operation
1		-----	The current chamber temperature is displayed.
2	Press calibration key for 5 seconds.	CAL	The left digit on the digital temperature display blinks.
3	By pressing digit shift key and numerical value key, set the figure to F26.		When pressed, the settable digit is shifted.
			When pressed, the figure of settable digit changes.
4	Press enter key.	ENT	The current set value is displayed in digital CO ₂ density indicator. The right digit blinks.
5	By pressing numerical value key, set the value to 000.		When pressed, the figure of the right digit changes.
6	Press enter key.	ENT	Set value is memorized. The current chamber temperature is displayed.

Note:

- In the no humidifying mode, the water level sensor function is cancelled (Water level alarm lamp (RH PAN) does not light).
- In each setting mode, if the change of the setting is not necessary, pressing set key (SET) skips to next setting mode.

SETTING OF CHAMBER TEMPERATURE AND CO₂ DENSITY

- In each setting mode, the indicator returns to the current temperature and CO₂ density display mode automatically when 90 seconds has passed without any key operation.
- Do not use the calibration key (CAL) on the control panel when the unit is under normal conditions. The unit enters calibration mode by pressing this key. Wrong key operation may affect the basic performance. When the unit enters calibration mode by mistake, wait for 90 seconds without any key operation until the control panel returns to chamber temperature display mode.

CAUTION

When operating in the no humidifying mode, drain all the water from the water reservoir. Remains of water may result in increasing humidity in chamber to about 80%R.H.

KEY LOCK FUNCTION

This unit is provided with a key lock function. When the key lock is ON, change of temperature or CO₂ density setting through the key pad is not available.

Note: The factory default setting value is OFF(L0).

Display	Mode	Function
	Key lock is OFF	Enable to change of temperature and CO ₂ setting
	Key lock is ON	Disable to change of temperature or CO ₂ setting

Procedure for key lock setting (change from key lock OFF to key lock ON)

	Description of operation	Key operated	Indication after operation
1		----	The current chamber temperature and CO ₂ density are displayed.
2	Press digit shift key for 5 seconds.		L0 is displayed in the digital temperature indicator.
3	Press numerical value shift key and scroll the figure to 1.		When pressed, the figure of settable digit changes.
4	Press enter key.	ENT	The key lock is set to ON. The current chamber temperature is displayed.

Note:

- The key lock function is available for temperature and CO₂ density setting.
- To cancel the key lock, set to L0 in the above procedure.

ALARMS & SAFETY FUNCTIONS

This unit has the alarms and safety functions shown in the table below, and also self diagnostic functions.

Alarms and safety functions

Alarm & Safety	Situation	Indication	Buzzer	Safety operation
Upper limit temperature alarm	If the chamber temperature exceeds the upper limit alarm temperature set value.	Over heat lamp lights. E12 or E16 and chamber temperature are displayed alternately.	Continuous tone	Heater OFF Remote alarm
Automatic set temperature alarm	If the chamber temperature deviates from the set temperature by ± 1.0 °C or more.	All digits on the digital temperature indicator blink.	Intermittent tone with 15 minutes delay.	Remote alarm with 15 minutes delay
Automatic set CO ₂ density alarm	If the chamber CO ₂ density deviates from the set value by ± 1.0 % or more.	All digits on the digital CO ₂ density indicator blink.	Intermittent tone with 15 minutes delay.	Remote alarm with 15 minutes delay
Auto-return	When there is no key pressing in each setting mode for 90 seconds.	Normal display mode.	-----	The setting mode is canceled.
Key lock	When the key lock is "ON".	-----	-----	The setting is disabled.
Automatic calibration function	Normally, the zero point of the CO ₂ sensor is calibrated every 4 hours (or very 10 minutes for the first hour after switch ON), using the atmosphere as the gas to be calibrated.	The decimal point (period) on the digital CO ₂ density indicator blinks.	----	----
CO ₂ gas cylinder empty	If the CO ₂ density does not increase when the gas valve is opened.	E01 is displayed alternately with the temperature on the digital temperature indicator.	Intermittent tone	Remote alarm
Gas line changeover	When the gas supply line is switched. (only when MCO-80GC is installed)	E01 is displayed alternately with the temperature on the digital temperature indicator. Gas supply line indicator blinks.	Intermittent tone	Gas supply line is altered. Remote alarm
Chamber temperature sensor abnormality	If the temperature sensor is disconnected.	E05 is displayed alternately with the temperature on the digital temperature indicator.	Intermittent tone	Heater OFF Remote alarm
	If the temperature sensor is short circuited.	E06 is displayed alternately with the temperature on the digital temperature indicator.		
Sensor box temperature sensor abnormality	If the sensor box temperature sensor is disconnected.	E07 is displayed alternately with the temperature on the digital temperature indicator.	Intermittent tone	CO ₂ valve close. Remote alarm
	If the sensor box temperature sensor is short circuited.	E08 is displayed alternately with the temperature on the digital temperature indicator.		
Ambient temperature sensor abnormality	If the ambient temperature sensor is disconnected.	E09 is displayed alternately with the temperature on the digital temperature indicator.	Intermittent tone	Remote alarm
	If the ambient temperature sensor is short circuited.	E10 is displayed alternately with the temperature on the digital temperature indicator.		
CO ₂ sensor abnormality	If the output voltage of the CO ₂ sensor is abnormal.	E11 is displayed alternately with the temperature on the digital temperature indicator.	Intermittent tone	CO ₂ valve close. Remote alarm
Main heater abnormality	If the upper limit alarm temperature alarm operates, or if the main heater or the main heater relay is open circuit.	E12 is displayed alternately with the temperature on the digital temperature indicator.	Intermittent tone	Remote alarm
Bottom heater abnormality	If the bottom heater or the bottom heater relay goes open circuit.	E13 is displayed alternately with the temperature on the digital temperature indicator.	Intermittent tone	Remote alarm

Alarm & Safety	Situation	Indication	Buzzer	Safety operation
Door heater abnormality	If the door heater or the door heater relay goes open circuit.	E14 is displayed alternately with the temperature on the digital temperature indicator.	Intermittent tone	Remote alarm
Sensor box heater abnormality	If the sensor box heater or the sensor box relay goes open circuit.	E15 is displayed alternately with the temperature on the digital temperature indicator.	Intermittent tone	Remote alarm
Disconnection of sensor for each heater	If the relay of main heater, bottom heater or sensor box heater goes open circuit.	E16 is displayed alternately with the temperature on the digital temperature indicator.	Intermittent tone	Remote alarm
Air pump (for sample air or auto-zero) failure	If the air pump (sampling or auto zero) does not operate, or if there is something wrong in the gas piping.	E17 is displayed alternately with the temperature on the digital temperature indicator.	Intermittent tone	Remote alarm
Low humidifying water	If the water in the water reservoir is about 5 L.	Water level alarm lamp blinks.	-----	Bottom heater OFF
UV lamp failure	[when MCO-80UVS is installed] When the UV lamp does not light in 30 seconds after the door is closed.	E18 is displayed alternately with the temperature on the digital temperature indicator.	Intermittent tone	Remote alarm
Flange heater abnormality	If the flange heater or the flange heater relay goes open circuit.	E19 is displayed alternately with the temperature on the digital temperature indicator.	Intermittent tone	Remote alarm
Glass frame heater abnormality	If the glass frame heater or the glass frame heater relay goes open circuit.	E20 is displayed alternately with the temperature on the digital temperature indicator.	Intermittent tone	Remote alarm
Water sensor (level) abnormality	If the water sensor of water level goes open circuit or short circuit.	E21 is displayed alternately with the temperature on the digital temperature indicator.	Intermittent tone	Bottom heater OFF Remote alarm
Water sensor (standard temperature) abnormality	If the water sensor of standard temperature goes open circuit or short circuit.	E22 is displayed alternately with the temperature on the digital temperature indicator.	Intermittent tone	Bottom heater OFF Remote alarm
Door alarm	When the outer door is open.	Door lamp lights.	-----	Fan stops.

- The buzzer can be canceled by pressing the alarm buzzer stop key (BUZZER), but the remote alarm cannot be silenced.
- Once upper limit temperature alarm is activated, the over heat lamp will remain blinking even after the temperature is resumed. Press the upper limit alarm reset key (RESET) to cancel the lighting.
- E01 is cleared automatically when the gas is connected correctly and the buzzer is silenced with the alarm buzzer stop key (BUZZER). When MCO-80GC is installed, press the alarm buzzer stop key (BUZZER) to silence the alarm after changeover of gas supply line.
- When any of the error from E05 to E17 (except for upper limit temperature alarm activating situation of E12, E13, and E14) is displayed, consult with our sales representative or agent.

SETTING OF ALARM RESUME TIME





The buzzer is silenced by pressing alarm buzzer stop key (BUZZER) on the control panel during alarm condition.

The buzzer will be activated again after certain suspension if the alarm condition is continued. The suspension time can be set by following the procedure shown in the table below.

The example in the table is based on the assumption that the desired duration is 20 minutes.

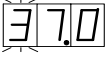
Note: The factory default setting value is 30 minutes duration.

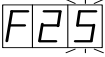
Table Changing procedure for alarm resume time (Ex: change from 30 minutes to 20 minutes)

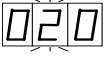
	Description of operation	Key operated	Indication after operation
1		----	The current chamber temperature is displayed.
2	Press calibration key for 5 seconds.		The left digit blinks. 
3	Set the figure to F25 with the digit shift key and numerical value shift key.		The settable digit is shifted.
			When pressed, the figure of settable digit changes. 
4	Press enter key.	ENT	The current setting is displayed in digital CO ₂ density indicator. The middle digit blinks. 
5	Set the figure to 020 with the numerical value shift key.		When pressed, the figure of settable digit changes. 
6	Press enter key.	ENT	The setting is memorized and the current chamber temperature is displayed.

- The settable alarm resume time are 0, 10, 20, 30, 40, 50, or 60 minutes (The setting is 000, 010, 020, 030, 040, 050 or 060 respectively). The buzzer would not reset if the resume time is set in 000.
- The set mode returns to the temperature display mode automatically when 90 seconds has passed without any key operation. In this case, any setting before pressing enter key is not memorized.

WARNING

Do not use calibration key (CAL) on the control panel in normal use. Pressing this key leads the calibration mode. Wrong key operation affects the basic performance. Never touch any other keys on the control panel in the event of pressing calibration key (CAL) accidentally. After about 90 seconds, the unit returns to chamber temperature display mode automatically.

Operation after power failure

The set value is memorized by nonvolatile memory. Accordingly, the incubator resumes the operation with setting before power failure.

ROUTINE MAINTENANCE

WARNING

Always disconnect the power supply to the unit prior to any repair or maintenance of the unit in order to prevent electric shock or injury.

The water level sensor periodically generates heat at around 70 °C that may be cause of burn injury.

Ensure you do not inhale or consume medication or aerosols from around the unit at the time of maintenance. These may be harmful to your health.

CAUTION

Always put on dry gloves to protect hands at the time of maintenance. Failure to use gloves may result in cuts or abrasions from any sharp edges or corners.

Do not put too much force for cleaning of the water level sensor, wipe it off lightly.

Sterilizing of chamber and attachments

When the chamber of the unit is contaminated, the chamber and internal attachments should be cleaned and sterilized as follows.

Note:

Take care not to damage the UV lamp (when an optional UV system set MCO-80UVS is installed) or water level sensor at the time of removal or replacement of attachments.

Do not clean the inside of the unit with a solution of sodium hypochlorite or other halogen-based solution because this may cause corrosion of metal surfaces.

1. Turn off power switch of the unit.
2. Open the outer door, and take out all trays and tray supports from the chamber. See Fig.1.
3. Remove screws of the ceiling panel consisting of two panels and remove them. See Fig.2.
4. Lift the bottom cover from the pins to remove the bottom cover. See Fig.3.

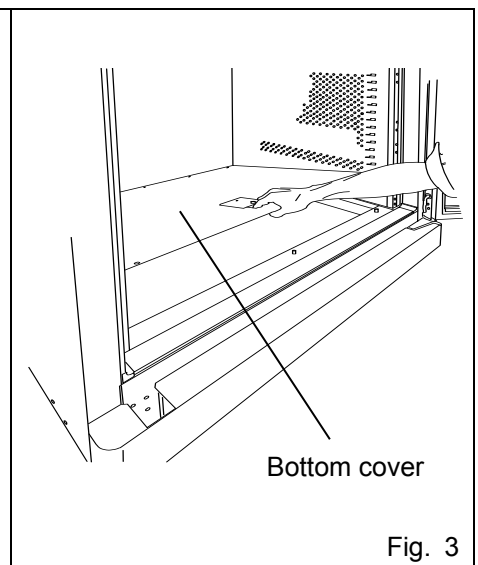
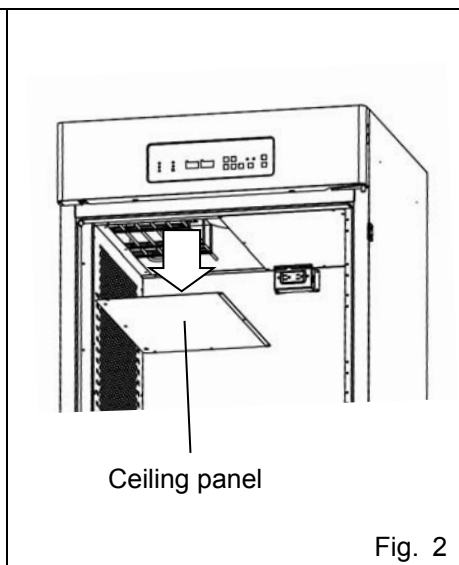
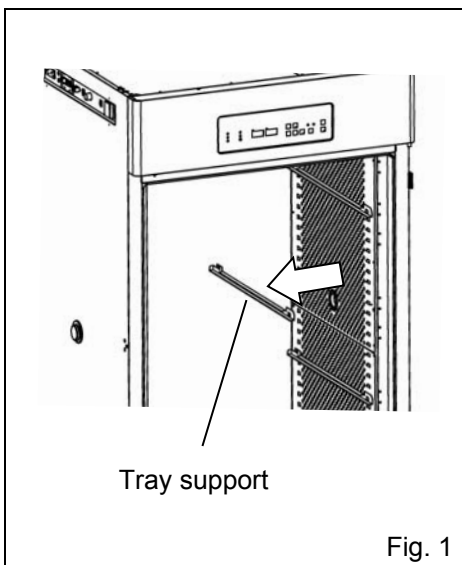

ROUTINE MAINTENANCE

5. Remove screws of the side ducts to dismount four side ducts. See Fig.4.

6. Remove screws at the lower both side to remove the front panel lower cover (Fig.5). Open the drain cock to drain all humidifying water, and it will drain through the drain outlet (Fig.6). Wipe off remained water with a dry gauze.

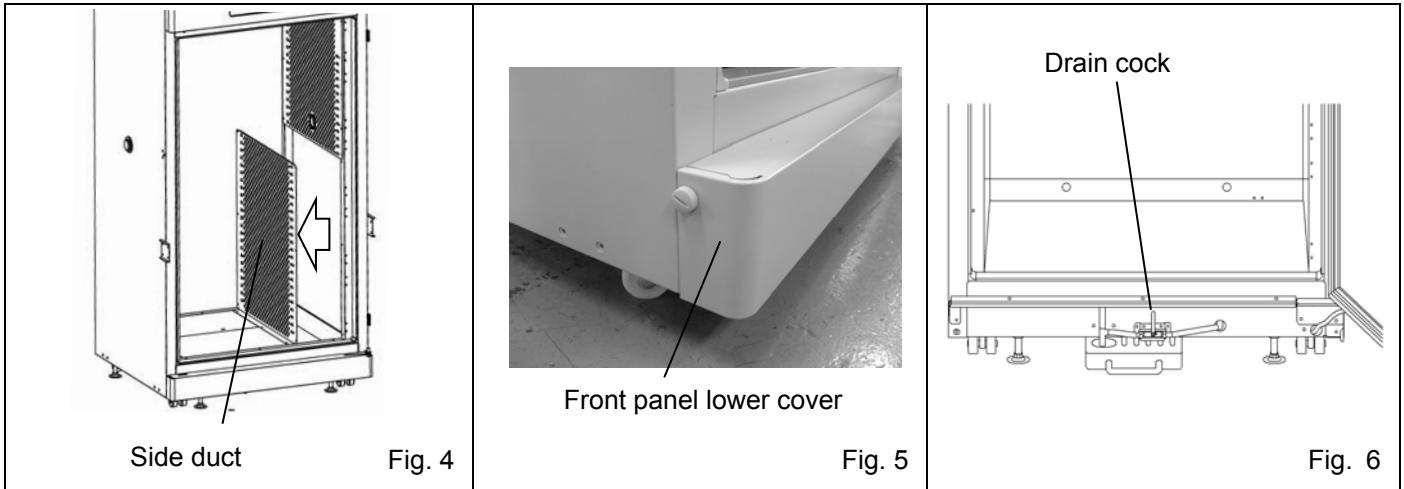

7. Clean all the attachments with neutral detergent and then rinse away the detergent with distilled water.

8. Wipe the attachments with a gauze containing alcohol for sterilization and then wipe off with a dry gauze.

9. Wipe the inside wall of the chamber and water reservoir with a gauze containing alcohol for sterilization and then wipe off with a dry gauze.

10. Wipe the water level sensor with a gauze containing alcohol for sterilization and then wipe off with a dry gauze. Care should be taken not to stress the water level sensor.

11. Replace all attachments in the chamber with the reversed order mentioned above.

12. When operating in the normal mode or the high humidity mode, fill the water reservoir with sterile distilled water. See page 31. If operating in the no humidifying mode, do not supply any water into the water reservoir.

Note:

- As shown in the fig.7, set the trays with the edge bent downwardly positioned at the front. Improper setting may cause tilted or unstable condition.

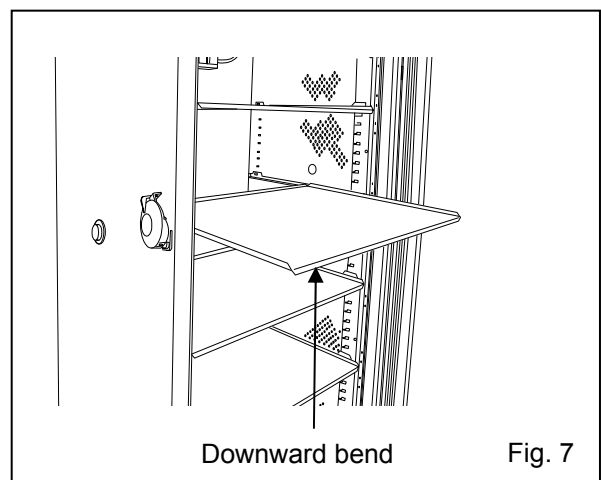

Filling water reservoir

To fill the water reservoir, do the following:

1. Open the outer door and remove the lowest tray. See Fig.1.
2. Remove a screw in front side and rotate the water supply inlet cover to open the water supply inlet. See Fig.2.
3. When there is no water in the water reservoir (for example, first time to operate), add approximately 20 L of preheated sterile distilled water at 37 °C. When the water level alarm lamp (RH PAN) is blinking, add approximately 15 L of preheated sterile distilled water at 37 °C. See Fig.3. It might take approximately 2 minutes until the lamp goes off.
4. Make sure the water level alarm lamp (RH PAN) on the control panel does not blink.
5. Rotate back the water supply inlet cover and tighten the removed screw.
6. Put the lowest tray back in place and close the outer door.

Note:

- Add sterile distilled water as water for humidifying. The ion exchange water is not fit to use.
- The sterile water filled in the water reservoir should be pre-heated at 37 °C. Cold water lowers the chamber temperature and humidity.

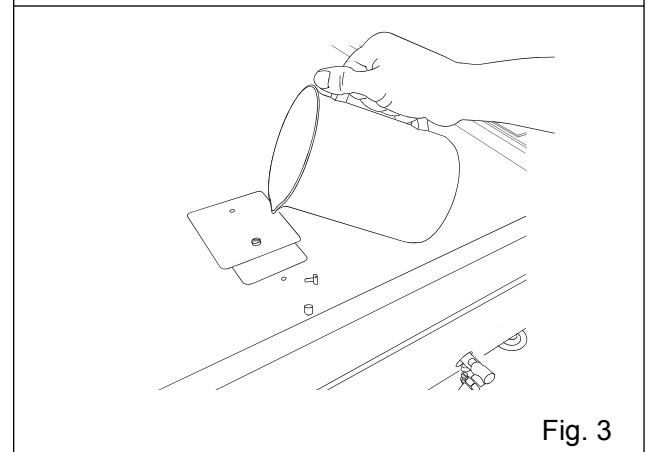
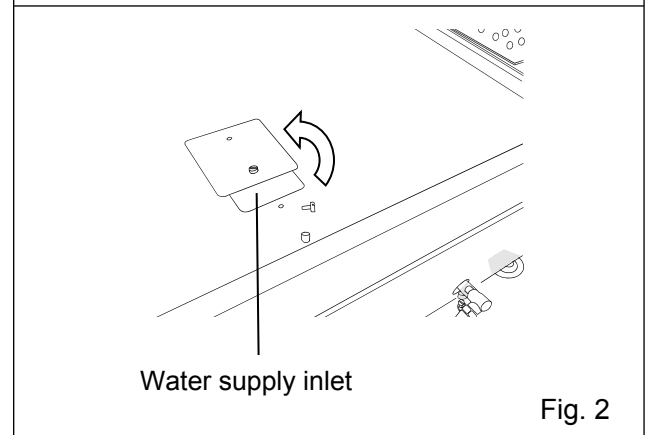
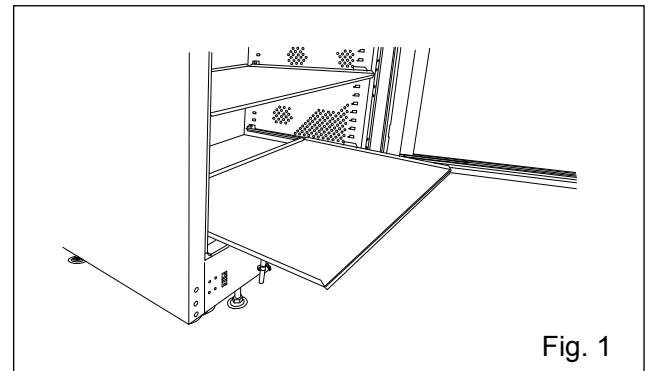

CALIBRATION

Temperature calibration

1. Press the calibration key (CAL) for approximately 5 seconds.
2. The third digit of the digital temperature indicator flashes, and the digital CO₂ density indicator goes out.
3. Set the present correct temperature with the digit shift key (▶▶) and numerical value shift key (▲), then press the enter key (ENT).
4. The unit automatically reverts to the display mode.

[Example]

If the displayed chamber temperature is 37.0 °C (set value) and the actual temperature is 36.8 °C.

1. Press the calibration key (CAL) for about 5 seconds.
2. The "3" on the digital temperature indicator flashes, and the digital CO₂ density indicator goes out.
3. Adjust the set value to the actual value of 36.8°C with the digit shift key (▶▶) and numerical value shift key (▲), then press enter key (ENT).
4. The unit automatically reverts to the display mode.

Note:

It is important to accurately measure the temperature inside the unit when performing temperature calibration. Particularly, the temperature gauge used must have an accuracy of 0.5 Class or better. The temperature must be measured at several points.

The temperature setting must not change by more than ± 1.0 °C during calibration. If it exceeds this, an error tone is emitted, the input data is ignored, and the unit reverts to the display mode. Consequently, if it is necessary to change the temperature by more than 1.0 °C, perform calibration in several stages over a period of time.

CO₂ calibration

Span setting

Span setting should be done under stable condition of temperature, humidity, and CO₂ density.

1. Press the calibration key (CAL) for about 5 seconds.
2. The third digit on the digital temperature indicator flashes, and the digital CO₂ density indicator goes out.
3. Press the calibration key (CAL) once again.
4. The third digit on the digital CO₂ density indicator flashes, and the digital temperature indicator goes out.
5. Set the present correct CO₂ density with the digit shift key (▶▶) and numerical value shift key (▲), then press the enter key (ENT).
6. The unit automatically reverts to the display mode.

Note:

This calibration is available when the setting of CO₂ density is 2 % or more.

[Example]

For an internal CO₂ density of 5.0 % (setting) and a measured value of 4.5 %.

1. Press the calibration key (CAL) for about 5 seconds.
2. The third digit on the digital temperature indicator flashes, and the digital CO₂ density indicator goes out.
3. Press the calibration key (CAL) once again.
4. The third digit on the digital CO₂ density indicator flashes, and the digital temperature indicator goes out.
5. Set the present correct CO₂ density (4.5 %) with the digit shift key (▶▶) and numerical value shift key (▲), then press the enter key (ENT).
6. The unit automatically reverts to the display mode.

TROUBLESHOOTING

If the unit malfunctions, check out the following before calling for service.

Malfunction	Check/Remedy
The unit does not operate at all.	<ul style="list-style-type: none"> • The unit is not plugged correctly into a power outlet. • The circuit breaker at the power source is active or a power failure has occurred.
The key operation is disable	<ul style="list-style-type: none"> • The key lock function is set in ON mode.
If the alarm function and the buzzer operates	<p>[At the beginning of operation]</p> <ul style="list-style-type: none"> • The chamber temperature is not equal to the set value. • The chamber CO₂ density is not equal to the set value. <ol style="list-style-type: none"> a. The secondary pressure of the gas regulator is not equal to the set value (0.1 MPa(G), 1.0 kgf/cm²(G), 14.5 psi(G)). b. The tube is not connected securely between the gas regulator and the unit. <p>[During operation]</p> <ul style="list-style-type: none"> • The upper limit alarm temperature is not set at least 1 °C higher than the set chamber temperature. • The set temperature value was changed, or the door was left open for a long period. Or a low temperature load was placed inside the unit. In this case, if the unit is left as it is, the alarm will eventually clear itself. • The gas tube has slipped off or the gas leaks. • The set value of the gas density was changed. • The gas cylinder is empty. Check the primary pressure of the CO₂ cylinder once a week. (The primary pressure of less than 3.8 MPa(G) (38 kgf/cm²(G), 551.1 psi(G)) means a little gas in the cylinder. Replace the cylinder soon.) • While an equipment are operated in chamber. (Generation of heat by the equipment raises temperature in chamber)
If the chamber temperature is not equal to the set temperature	<ul style="list-style-type: none"> • The ambient temperature must always be at least 5 °C less than the set temperature.
If the gas density does not coincide with the set value	<ul style="list-style-type: none"> • The secondary pressure is not set to 0.1 MPa(G) (1.0 kgf/cm²(G), 14.5 psi(G)). • The gas tube is clogged or chinked.
If the chamber humidity does not rise	<ul style="list-style-type: none"> • The water reservoir is not filled with sterile distilled water. (Always use sterile distilled water.) • The no humidifying mode is set.
If the CO ₂ consumption is too much	<ul style="list-style-type: none"> • The door is opened frequently. • There is any gas leakage at the connection or pin hole on the tube. It is recommended to replace the tube once a year. • An access port is opened.
If normal cultivation cannot be done and chamber gas density is suspect	<ul style="list-style-type: none"> • The environment around the unit is not normal. The source of the contaminated gas is nearby. • The unit is installed in an enclosed space.
If it takes much time to recover the gas density	<ul style="list-style-type: none"> • HEPA filter is provided in the gas piping. If it takes much time to recover the gas density even though the gas pressure is normal, it may be that dust on the HEPA filter prevents the gas flow. Consult the our sales representative or agent.
If CO ₂ gas is not injected	<ul style="list-style-type: none"> • The CO₂ injection system is ON-OFF controlled and injects gas intermittently when the set density is close. Injection might stop for 15 seconds but it is not abnormal.

Note:

If the malfunction is not eliminated after checking the chart in the preceding page, or the malfunction is not shown in the chart, contact our sales representative or agent.

DISPOSAL OF UNIT

 **WARNING**

If the unit is to be stored unused in an unsupervised area for an extended period **ensure that children do not have access and doors cannot be closed completely.**

The disposal of the unit should be accomplished by appropriate personnel. Always remove doors to prevent accidents such as suffocation.

AUTOMATIC CO₂ CYLINDER CHANGEOVER

Gas auto changer (MCO-80GC) is available as an optional accessory. This system switches the gas supply line when one CO₂ gas cylinder is empty.

Note: The installation of MCO-80GC should be implemented by a qualified service personnel.

After attachment of MCO-80GC, do the following:

1. Connect a CO₂ gas pipe to port A and B respectively. A connecting port for CO₂ gas pipe is located on the upper back of the unit. (See page 9).
2. Connect a CO₂ gas cylinder provided with a gas regulator to each gas pipe. See page 17, for the connection of the gas cylinder.
3. Open the valve of each gas cylinder.
4. Check that the CO₂ gas supply line indicator on the control panel is lit by pressing the CO₂ gas supply line switching key.
5. Select a CO₂ gas supply line (A or B).
6. When one cylinder is empty, the indicator blinks, buzzer sounds, and "E01" and current chamber temperature are displayed alternately on the digital temperature indicator while the gas supply line is switched to other one. To silence the buzzer, press the alarm buzzer stop key (BUZZER).
7. Replace the empty CO₂ gas cylinder.

Note: Exercise caution when handling empty CO₂ gas cylinders as some gas can be still be left in the cylinder.

This system MCO-80GC detects that no more CO₂ gas exists in a cylinder when the CO₂ density in the chamber is not increased for a while after opening of CO₂ gas valve in the unit and switches the gas supply line. The switching of supply line can be caused by some other reasons; blocking or restricting of gas tube, reduction of CO₂ gas pressure, or improper opening o
If the unit malfunctions, check out the following before calling for service.





AUTO WATER SUPPLY SYSTEM

Auto water supply system (MCO-80AS) is available as an optional accessory.

This system kit supplies water from its tank automatically when the water level alarm lamp(RH PAN) blinks due to decrease the water in the water reservoir.

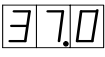
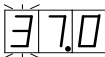
For starting to use auto water supply system, it is necessary to set F26 : 001 or 002 (refer to page 23), and F27 :001. Following procedure is the setting of F27.

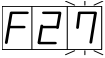
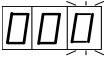
F27	Function
000	Automatic water supply OFF (default)
001	Automatic water supply ON

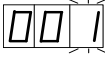
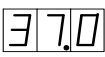
	Description of operation	Key operated	Indication after operation
1		----	The current chamber temperature is displayed. 
2	Press calibration key for 5 seconds.	CAL	The third digit on the digital temperature display is flashed. 
3	Set the figure to F27 with the digit shift key and numerical value shift key.		When pressed, the settable digit is shifted.
			When pressed, the figure of settable digit changes. 
4	Press enter key.	ENT	The current set value is displayed on the digital CO ₂ density indicator. The first digit is flashed. 
5	Set the figure to 001 with the numerical value shift key.		When pressed, the figure of the first digit changes. 
6	Press enter key.	ENT	Set value is memorized. The current chamber temperature is displayed. 

- When the water in the water reservoir decreases less than approximately 5 L, water is supplied little by little to prevent the water temperature from dropping rapidly. (The water supply valve is opened and closed repeatedly.)

- Automatic water supply stops its operation while the outer door is open.

- If the water supply tank becomes empty or the connection to the incubator is released, the automatic water supply operation is finished and doesn't restart automatically. Water level alarm lamp (RH PAN) will remain blinking though the buzzer is not activated.

To restart the automatic water supply, refill the tank (Capacity:20 L) and do either (1) or (2) below.

(1) If you want to minimize the impact on the chamber temperature.

Press alarm buzzer stop key (BUZZER). By pressing this key, the automatic water supply will start operating again. In this case, water is supplied little by little to minimize the change of the chamber temperature.

(2) If you want to refill the water reservoir in a short time.

Turn off the power switch once and turn on again.

The water reservoir is refilled rapidly by automatically keeping the water supply valve open for 2 minutes after the 2 minutes water level checking has been finished. In this case, water supply is completed in a short time but the chamber temperature will be temporarily dropped.

SPECIFICATIONS

Product name	CO ₂ Incubator MCO-80ICL
External dimensions	W986 mm x D853 mm x H2,040 mm (without caster; H1,975 mm)
Internal dimensions	W806 mm x D693 mm x H1,524 mm
Interior volume	851 L
Exterior	Painted steel
Interior	Stainless steel containing copper
Outer door	Double glass with door heater Outer door latch
Tray	5 trays made of stainless steel containing copper W776 mm x D659 mm x H10 mm, Maximum load; 30 kg/tray
Access port	Inner diameter; 40 mm, Two locations, each on both sides
Insulation	Slab board
Heater	Main heater: 600 W, Water reservoir heater: 211 W, Door frame heater: 125 W, Flange heater: 250 W, Glass heater: 150 W
Humidifying system	Normal mode: Natural evaporation with humidifying water High humidity mode: Heated evaporation with humidifying water
Temperature controller	PID control system
Temperature display	Digital display
CO ₂ controller	PID control system
CO ₂ density display	Digital display
Air circulation	Fan assisted
Air filter	0.3 µm, Efficiency; 99.97 % or more
Water level sensor	Thermal type
Alarm	High/Low temperature alarm, CO ₂ density alarm, Upper limit temperature alarm Door alarm
Remote alarm contact	Allowable contact capacity: DC 30 V, 2 A
CO ₂ inlet connection	4 mm to 6 mm diameter tube
CO ₂ inlet pressure	0.1 MPa(G) (1.0 kgf/cm ² (G), 14.5 psi(G))
Accessories	5 trays, 5 sets of tray support, 1 gas tube, 2 tube bands, 1 drain tank (6.5 L)
Power source	Single phase, 110 V-120 V, 60 Hz
Inside power outlet	Two sockets (Up to 3 A in total) Use condition: Inner temperature below 40 °C and humidity below 50%R.H.
Outer power outlet	Two sockets (Up to 1 A in total)
Weight	275 kg
Optional accessory	Gas auto changer (MCO-80GC) Tray (MCO-80ST) Same tray as the attached one including 2 tray supports Roller bottle rack mount (MCO-80RBS) Small door (MCO-80ID), UV system set (MCO-80UVS), Auto water supply system (MCO-80AS), Interface board (MCO-420MA, USA only), Interface board (MTR-480)*, Interface board (MTR-L03)*

*Only for the Data acquisition system MTR-5000 user.

Note: Refer to the updated catalog when ordering an optional component.

Designs and specifications are subject to change without notice.

PERFORMANCE

Product name	CO ₂ Incubator MCO-80ICL
Model number	MCO-80ICL-PA
Temperature control range	Ambient temperature +5 °C to 50 °C (ambient temperature; 20 °C to 35 °C)
Temperature distribution	±0.5 °C (ambient temperature; 25 °C, setting; 37 °C, 5 %, no load)
Temperature variation	±0.1 °C (ambient temperature; 25 °C, setting; 37 °C, 5 %, no load)
CO ₂ control range	0 % to 20 %
CO ₂ variation	± 0.15% (ambient temperature; 25°C, setting; 37°C, 5%, no load)
Chamber humidity	Normal mode; Over 80 %R.H. High humidity mode; Over 90 %R.H.
Maximum heat emission	6307 kJ/h
Usable environment condition	Temperature; 20 °C to 35 °C, Humidity; equal or less than 80 %R.H. (The designed performance may not be obtained when the ambient temperature is less than 20 °C)
Noise level	33 dB (A scale)
Maximum power consumption	1840 W
Total maximum current	AC 110 V-120 V, 60 Hz
	16.0 A

Note: All data above is based on our measuring method..

 **CAUTION**

**Please fill in this form before servicing.
Hand over this form to the service engineer to keep for his and your safety.**

Safety check sheet

1. Incubator contents :

- Risk of infection: Yes No
Risk of toxicity: Yes No
Risk from radioactive sources: Yes No

(List all potentially hazardous materials that have been stored in this unit.)

Notes :

2. Contamination of the unit

Unit interior

- No contamination Yes No
Decontaminated Yes No
Contaminated Yes No

Others:

3. Instructions for safe repair/maintenance/disposal of the unit

- a) The unit is safe to work on Yes No
b) There is some danger (see below) Yes No

Procedure to be adhered to in order to reduce safety risk indicated in b) below.

Date :

Signature :

Address, Division :

Telephone :

Product name : CO ₂ incubator	Model No. MCO-	Serial number :	Date of Installation :
---	-------------------	-----------------	------------------------

Please decontaminate the unit yourself before calling the service engineer.

PHC Corporation

1-1-1 Sakada, Oizumi-machi, Ora-gun, Gunma 370-0596, Japan

© PHC Corporation 2018

Printed in Japan
LDCL041600-0
S0418-0