

PHCbi

Operating Instructions

O₂/CO₂ Incubator

MCO-50M



Please read the operating instructions carefully before using this product, and keep the operating instructions for future use.

See page 96 for model number.

CONTENTS

INTRODUCTION	4
PRECAUTIONS FOR SAFE OPERATION.....	5
SYMBOLS ON INCUBATOR	10
ENVIRONMENTAL CONDITIONS	11
INCUBATOR COMPONENTS	12
Unit	12
Control panel	14
Remote alarm terminal	15
INSTALLATION.....	16
Installation site	16
Installation.....	17
Connecting a CO ₂ gas cylinder	19
Connecting N ₂ /O ₂ gas cylinders	21
BEFORE STARTING OPERATION.....	22
Initial cleaning method.....	22
Removing inner attachments.....	23
Installing inner attachments.....	25
Filling the humidifying pan	26
FOR OPTIMAL CULTIVATION	27
Precautions for cultures.....	27
Preventing contamination	28
CORRECT OPERATION	29
HOME SCREEN	30
MENU SCREEN	32
BASIC PARAMETERS	34
Setting temperature	34
Setting CO ₂ gas	35
Setting CO ₂ density	36
Setting O ₂ gas.....	37
Setting O ₂ density	38
Setting high limit temperature alarm.....	39
Automatic N ₂ (O ₂) gas cylinder switching	40
Manual N ₂ (O ₂) gas supply line A/B switching	41
OPERATION/ALARM LOG.....	42
Displaying operation log	42
Exporting operation log.....	45
Setting log interval	47
Setting Unique ID	48
Displaying alarm log	49
Exporting alarm log.....	50
KEY LOCK FUNCTION	52
Setting key lock	52
Cancelling key lock.....	53

CONTENTS

ELECTRIC LOCK (OPTION).....	54
Setting door lock.....	54
Setting door lock delay time	55
Specifying the method to unlock the outer door	56
Unlocking the outer door with a User ID.....	57
Unlocking the outer door during a power outage or malfunction.....	57
Registering user ID/password	58
Deleting User IDs	60
ALARM PARAMETERS.....	61
Setting temperature alarm.....	61
Setting temperature alarm delay	62
Setting CO ₂ density alarm	63
Setting CO ₂ density alarm delay.....	64
Setting O ₂ density alarm.....	65
Setting O ₂ density alarm delay	66
Setting door alarm delay.....	67
Setting ring back delay	68
Setting remote alarm	69
UV LAMP (OPTION).....	70
Using UV lamp.....	70
Setting UV lamp ON period	71
UV lamp life indication.....	72
Automatic extension of UV lamp ON period.....	73
Lighting UV lamp for 24 hours.....	74
GAS AUTO CHANGER (OPTION).....	75
Connecting CO ₂ gas cylinders.....	75
Automatic CO ₂ gas supply line switching	75
Manual CO ₂ gas supply line A/B switching.....	77
OTHER PARAMETERS.....	78
Setting date display format.....	78
Setting date	79
Setting time.....	80
Setting keypad clicking sound	81
H ₂ O ₂ DECONTAMINATION (OPTION).....	82
H ₂ O ₂ decontamination	82
ALARMS, SAFETY, AND SELF-DIAGNOSIS.....	86
ROUTINE MAINTENANCE	90
TROUBLESHOOTING.....	91
DISPOSAL OF UNIT.....	93
SPECIFICATIONS.....	94
PERFORMANCE.....	96
SAFETY CHECK SHEET	97

INTRODUCTION

- Read the operating instructions carefully before using the product and follow the instructions for safe operation.
- PHC Corporation takes no responsibility for safety if the product is not used as intended or is used with any procedures other than those given in the operating instructions.
- Keep the operating instructions in a suitable place so that they can be referred to as necessary.
- The operating instructions are subject to change without notice for improvement of performance or function.
- Contact our sales representative or agent if any page of the operating instructions is lost or the page order is incorrect, or if the instructions are unclear or inaccurate.
- No part of the operating instructions may be reproduced in any form without the express written permission of PHC Corporation.

IMPORTANT NOTICE

PHC Corporation guarantees this product under certain warranty conditions. However, please note that PHC Corporation shall not be responsible for any loss or damage to the contents of the product.

<Intended Use>

This equipment is designed for providing an environment with controlled temperature, CO₂, O₂, N₂ and elevated humidity for the development of ova or embryos at or near physiological conditions.

PRECAUTIONS FOR SAFE OPERATION

It is imperative that the user complies with the operating instructions as they contain important safety advice.

Items and procedures are described so that this unit can be used correctly and safely. Following these precautions will prevent possible injury to the user and any other person.

Precautions are illustrated in the following way:



WARNING

Warning indicates a potentially hazardous situation which, if not avoided, could result in serious injury or death.

CAUTION

Failure to observe CAUTION signs could result in injury to personnel and damage to the unit and associated property.

Symbols have the following meaning;

-  This symbol means caution.
-  This symbol means an action is prohibited.
-  This symbol means an instruction must be followed.

WARNING

As with any equipment that uses CO₂ gas, there is a likelihood of oxygen depletion in the vicinity of the equipment. It is important that you assess the work site to ensure there is suitable and sufficient ventilation. If restricted ventilation is suspected, then other methods of ensuring a safe environment must be considered. These may include atmosphere monitoring and warning devices.

USA Only (Model with a lamp): This product has a lamp that contains mercury. Disposal may be regulated in your community due to environmental considerations. For disposal or information, please visit PHC website: <https://www.phchd.com>.

Contains mercury / Contenu avec mercure

For more information on safe handling procedures, the measures to be taken in case of accidental breakage and safe disposal options visit:
ec.gc.ca/mercure-mercury/.
Dispose of or recycle in accordance with applicable laws.

Pour plus de renseignements sur les procédures de manutention sécuritaire, les mesures à prendre en cas de bris accidentel et les options d'élimination sécuritaire visitez:
ec.gc.ca/mercure-mercury/.
Mettez au rebut ou recyclez conformément aux lois applicables.













For the State of California, USA Only:

This product contains a CR Coin Cell Lithium Battery which contains Perchlorate Material – special handling may apply. See www.dtsc.ca.gov/hazardouswaste/perchlorate.

Be sure to keep the operating instructions in a place that is accessible to users of this unit.















PRECAUTIONS FOR SAFE OPERATION

WARNING

-  **Do not use the unit outdoors.** Exposure to rain may cause leakage and/or electric shock.
-  **Only qualified engineers or service personnel should install the unit.** The installation by unqualified personnel may cause electric shock or fire.
-  **Install the unit in a location capable of bearing the total combined weight (product + optional accessories + stored items). After installing the unit, be absolutely sure to take precautions to prevent the unit from falling over.** If the unit is installed in a location which is not strong enough or if the proper precautions are not taken, the unit may fall over and cause injuries.
-  **Do not install the unit where there are high levels of moisture or where it may be splashed with water.** Installing the unit where there are high levels of moisture or where it may be splashed with water may cause the insulation to deteriorate and give rise to leakage and/or electric shock.
-  **Do not install the unit in a location where flammable or volatile substances are present.** Installing the unit in a location where flammable or volatile substances are present may cause explosions and/or a fire.
-  **Do not install the unit in a location where corrosive gases such as acids are present.** Installing the unit in a location where corrosive substances are present may cause electric components to corrode, leading to leakage and/or electric shock due to the deterioration of insulation resulting from corroded electrical components.
-  **Do not place this unit in a location where it is difficult to disconnect the power supply plug.** Failure to disconnect the power supply plug may cause fire in the event of a problem or malfunction.
-  **Be absolutely sure to earth (ground) the unit in order to prevent electric shock.** Failure to earth the product may give rise to electric shock. If necessary, ask a qualified contractor to do this work.
-  **Do not connect the earth wire to a gas pipe, water pipe, or lightning rod when earthing the unit.** Earthing the unit improperly may give rise to electric shock.
-  **Connect the unit to a power source as indicated on the rating label attached to the unit.** Use of any other voltage or frequency other than that on the rating label may cause fire or electric shock.
-  **Never store volatile or flammable substances in this unit except in a sealed container.** Such substances may cause explosion or fire if they leak.
-  **Never insert metal objects such as pins and wires into any vent, gap or outlet on the unit.** This may cause electric shock or injury by accidental contact with moving parts.
-  **When handling harmful samples (for example, those which consist of toxic, pathogenic, or radioactive substances), install the unit inside a designated isolation facility.** If the unit is installed in a location which is not an isolation facility, there may be detrimental effects on both people and the natural environment.













PRECAUTIONS FOR SAFE OPERATION

WARNING

-  **Before proceeding with maintenance or checking of the unit, set the power switch to OFF and disconnect the power supply plug.** Performing the work while power is still flowing to the product or while the power-supply plug is still connected may give rise to electric shock and/or injury.
-  **Do not touch any electrical parts (such as power supply plug) or operate switches with a wet hand.** This may cause electric shock.
-  **Wear protective gloves and mask during maintenance.** Touching or inhaling chemicals or aerosols from around the unit may be detrimental to health.
-  **Never splash water directly onto the unit** as this may cause electric shock or short circuit.
-  **Never put containers with liquid on top of the unit** as this may cause electric shock or short circuit if the liquid is spilled.
-  **Never damage the power supply cord or power supply plug (by breaking, adapting, placing near a source of heat, bending with force, twisting, pulling, adding weight, or binding).** A damaged power supply cord or power supply plug may cause electric shock, short circuit, or fire.
-  **Do not use the supplied power cord for other electrical equipment.** Such power supply cord may cause fire or electric shock.
-  **Never disassemble, repair, or modify the unit yourself.** A high-voltage area is located inside the unit. Any work carried out by an unauthorized personnel may result in electric shock. Contact our sales representative or agent for maintenance or repair.
-  **Make sure the power supply plug is pushed fully in.** Faulty insertion of the power supply plug may cause electric shock or fire due to generation of heat. Never use a damaged power supply plug or loose power outlet.
-  **Disconnect the power supply plug if there is anything wrong with the unit.** Continued abnormal operation may cause electric shock or fire.
-  **Grip the power supply plug when disconnecting the power supply cord from the outlet.** Pulling the power supply cord may cause electric shock or short circuit.
-  **Remove dust from the power supply plug periodically.** Dust on the power supply plug may cause insulation failure due to moisture and thus cause a fire. Disconnect the power supply plug and wipe it with a dry cloth.
-  **Disconnect the power supply plug** before moving the unit. Take care not to damage the power supply cord. A damaged cord may cause electric shock or fire.
-  **Disconnect the power supply cord when the unit is not in use for long periods.** Keeping the unit connected may cause electric shock, leakage, or fire due to the deterioration of insulation.
-  **If the unit is to be stored unused in an unsupervised area for a long period, ensure that children do not have access and that doors cannot be closed completely.**













PRECAUTIONS FOR SAFE OPERATION

WARNING

-  **Ask a qualified contractor to carry out disassembly and disposal of the unit.** Leaving the unit in a location that can be accessed by third parties may result in unexpected accidents (e.g. the unit may be used for unintended purposes).
-  **Do not leave the plastic bags used for packing in a place where they can be reached by small children** as this may result in unexpected accidents such as suffocation.
-  **Use the reagent specified by our company for H₂O₂ decontamination.** Using a different H₂O₂ solution may result in explosion or damage to the incubator.
-  When performing H₂O₂ decontamination, **securely close the internal and external doors.** Failure to do so may be harmful to health due to leakage of H₂O₂ gas.
-  During H₂O₂ decontamination, **plug the access hole with the silicon cap that is provided.** Failure to do so may be harmful to health due to leakage of H₂O₂ gas.
-  **Always use the removal power supply cord that is provided.** Other power supply cord may cause electric shock or fire.
-  When using CO₂/N₂ gas for control, **make sure that there is adequate ventilation.** Using CO₂/N₂ gas in a small room without adequate ventilation may cause gas poisoning or oxygen deprivation. In addition, when opening the incubator doors, do not directly inhale the air in the chamber.
-  When connecting a gas cylinder to the incubator, **confirm the gas type. Confirm that the connections are secure and that no gas will leak. Be sure to use the specified pressure.** Using an incorrect gas or pressure may result in explosion or fire, or in gas poisoning or oxygen deprivation due to gas leak.
-  O₂ gas increases the susceptibility of substances to burn. Take care of the handling of flame in a room where the incubator is installed.
-  **Install the incubator in a location with adequate ventilation.** If adequate ventilation cannot be provided, then install an alarm system using CO₂ and O₂ densitometers.
-  **Do not look directly at UV light.** UV light is harmful to the eyes.
-  Never start H₂O₂ decontamination when “Warning: UV Bulb Life” is displayed in the message display area. The UV resolve is not sufficient.
-  **Do not use the unlock key to unlock the outer door during H₂O₂ decontamination or during H₂O₂ gas resolve by UV.** Doing so may cause harm to health from H₂O₂ gas leakage.





PRECAUTIONS FOR SAFE OPERATION

CAUTION

-  This unit must be plugged into a dedicated circuit protected by branch circuit breaker.
-  Use a dedicated power source as indicated on the rating label attached to the unit. A multiple-tap may cause fire resulting from abnormal heating.
-  **Never store corrosive substances such as acid or alkali** in this unit if the container cannot be sealed. These may cause corrosion of inner components or electric parts.
-  **Check the setting when starting up of operation after power failure or turning off of power switch.** The stored items may be damaged due to the change of setting.
-  **Be careful not to tip over the unit** during movement to prevent damage or injury.
-  **Prepare a safety check sheet** (copy the last page) when you request any repair or maintenance for the safety of service personnel.
-  **Wear rubber gloves when handling the H₂O₂ reagent.** Direct contact with the H₂O₂ reagent may result in inflammation of the skin.
-  H₂O₂ decontamination can be performed only for the chamber and chamber attachments with standard specifications, and not for any other objects.
-  **Perform H₂O₂ decontamination with the chamber attachments arranged as specified by our company.** Arranging them in a different way may result in insufficient decontamination.
-  After H₂O₂ decontamination has been completed, **wear rubber gloves and use a non-woven cloth to wipe off the residual H₂O₂ fluid from the bottom of the chamber, any objects that were decontaminated, and the bottoms of ducts.**
-  **Do not climb on top of the incubator or place any object on it.** By doing so you may damage the incubator or knock it over, which may result in injury.
-  **Wear rubber gloves when performing maintenance on the chamber.** Failure to wear gloves may result in cuts or abrasions from sharp edges or corners.
-  **Do not damage the glass or give it a shock.** The Inner door in the O₂/CO₂ Incubator are tempered glass, but they can be broken or cause injury if they are used incorrectly.

SYMBOLS ON INCUBATOR

The following symbols are attached to the incubator:

	Attached to covers that access high-voltage electrical components to prevent electric shock. Only a qualified engineer or service personnel should be allowed to open these covers.
	Indicates an ultraviolet light (UV) caution.
	Indicates that caution is required. Refer to precautions for safe operation for details.
	Indicates a hot surface.
	Indicates an earthing.
	Indicates "ON" for a power switch.
○	Indicates "OFF" for a power switch.

ENVIRONMENTAL CONDITIONS

This equipment is designed to be safe at least under the following conditions (based on the IEC 61010-1):

- Indoor use;
- Altitude up to 2,000 m;
- Temperature 5 °C to 40 °C;
- Maximum relative humidity 80 % for temperature up to 31 °C decreasing linearly to 50 % relative humidity at 40 °C;
- Mains supply voltage fluctuations up to ± 10 % of the nominal voltage;
- Transient overvoltages up to the levels of OVERVOLTAGE CATEGORY II;
- Temporary OVERVOLTAGES occurring on the mains supply;
- Applicable pollution degree of the intended environment (POLLUTION DEGREE 2 in most cases);

INCUBATOR COMPONENTS

Unit

Appearance

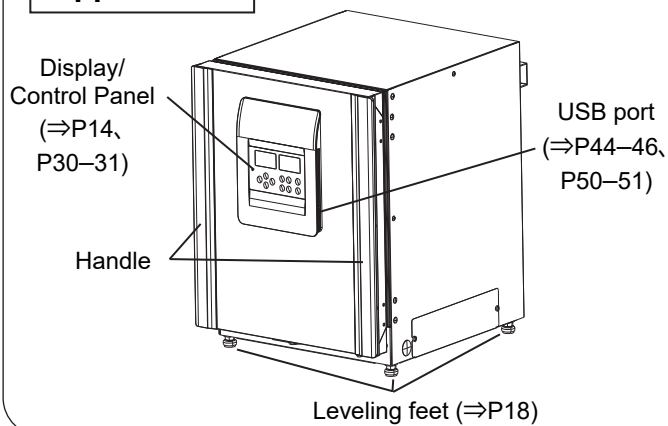

Back side

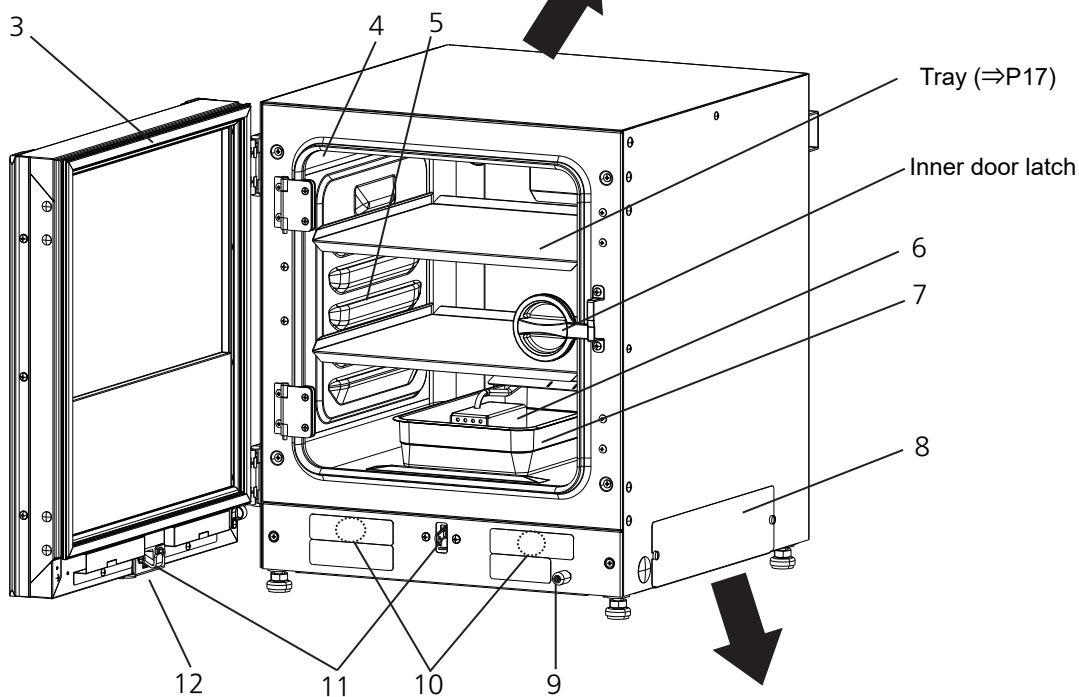
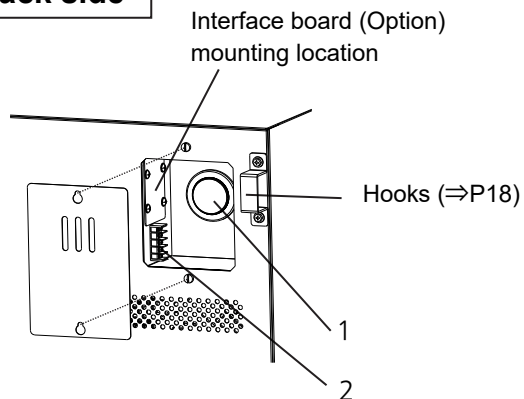

Inside

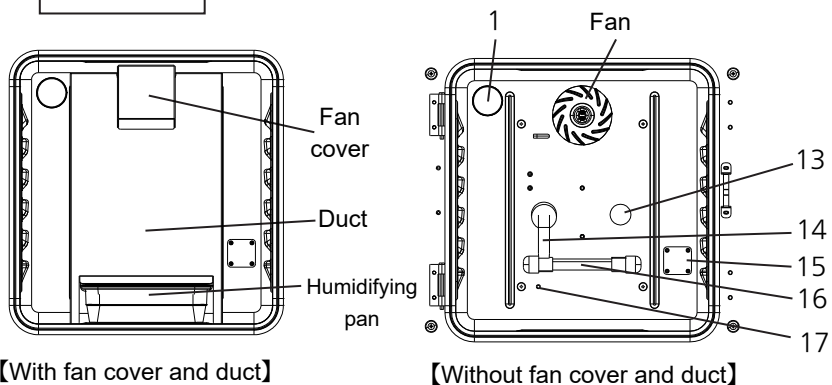

Lower right side

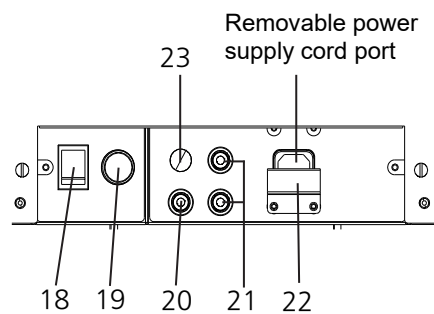

INCUBATOR COMPONENTS

- 1. Access port:** Used when routing cables such as the sensor cable of a measurement instrument into the chamber. Place the silicon caps on both the outside and inside of the port when the port is not used.
- 2. Remote alarm terminal:** An external alarm unit is connected to this terminal for transferring the alarm to a remote location. Refer to page 15.
- 3. Outer door:** The outer door is held to the frame with the magnetic seal. The door heater is installed in the door panel. The direction of the door opening is reversible. Contact our sales representative or agent to change the door hinge from left to right or vice versa.
- 4. Inner door:** The inner door is made of tempered glass. Do not subject the glass to excessive impact.
- 5. Tray catches:** Trays are inserted to fit these concave parts on the chamber walls.
- 6. Gas injection nozzle (Accessory):** Refer to page 17 for installation.
- 7. Humidifying pan (Accessory):** Fill with sterile distilled water.
- 8. Switch cover:** Prevents shutting down of the unit in case of accidental pressing of the main power switch.
- 9. Sample air outlet:** This also functions as an internal gas outlet. In normal use, cover this outlet with the sample air outlet cap.
- 10. Door switch (Beneath the label):** Detects the opening/closing status of the outer door. When the door is open, the electromagnetic valve for CO₂ is closed, the fan is stopped, and the UV lamp^{*1} is turned off.
- 11. Electric lock^{*2}:** Electric lock is the lock function that automatically locks the outer door when a set amount of time has elapsed after closing the outer door (refer to pages 54-60).
- 12. Key hole^{*2}:** Hole for the key to unlock the outer door when locked by the electric lock.
- 13. CO₂ sensor:** This sensor measures CO₂ density. Handle with care. Refer to page 22.
- 14. Humidity control bar:** Reduces condensation in the unit caused by the external environment and frequent door openings.
- 15. Position to mount the H₂O₂ decontamination connector:** Position to mount the optional H₂O₂ decontamination connector. Refer to page 82.
- 16. UV lamp^{*1}:** This UV lamp does not generate ozone. For replacement, contact our sales representative or agent.
- 17. Gas injection port:** N₂ gas (O₂ gas) is injected from here when controlling O₂ density. For faster recovery of humidity in the chamber, connect the gas injection port and the gas injection nozzle using the gas injection nozzle tube. Refer to page 17 for installation.
- 18. Power switch:** Main switch for the incubator (ON-"I", OFF-"O"). It also functions as an overcurrent breaker.
- 19. Glow starter^{*1}:** Starts the glow for the UV lamp.
- 20. Connecting port A for CO₂ gas pipe:** Refer to page 19 - 20 for gas cylinder connection.
- 21. Connecting port A/B for N₂ gas (O₂ gas) pipe:** Refer to page 21 for gas cylinder connection.
- 22. Power supply cord cover plate (Accessory):** Prevents the power supply cord from being disconnected.
- 23. Connecting port B for CO₂ gas pipe:** When the optional MCO-50GC gas auto-changer is installed, both ports A and B are available. Refer to pages 75 – 77.

*1: When an optional UV system set MCO-170UVS is installed.

*2: When an optional Electric lock MCO-170EL is installed.

INCUBATOR COMPONENTS

Control panel



When sterilizing and cleaning the control panel, follow the precautions below.

- (1) Do not spray liquid on the control panel directly.
- (2) When sterilizing and cleaning, wipe the surface using a piece of gauze moistened with a proper amount of disinfectant (the amount that cannot form droplets).

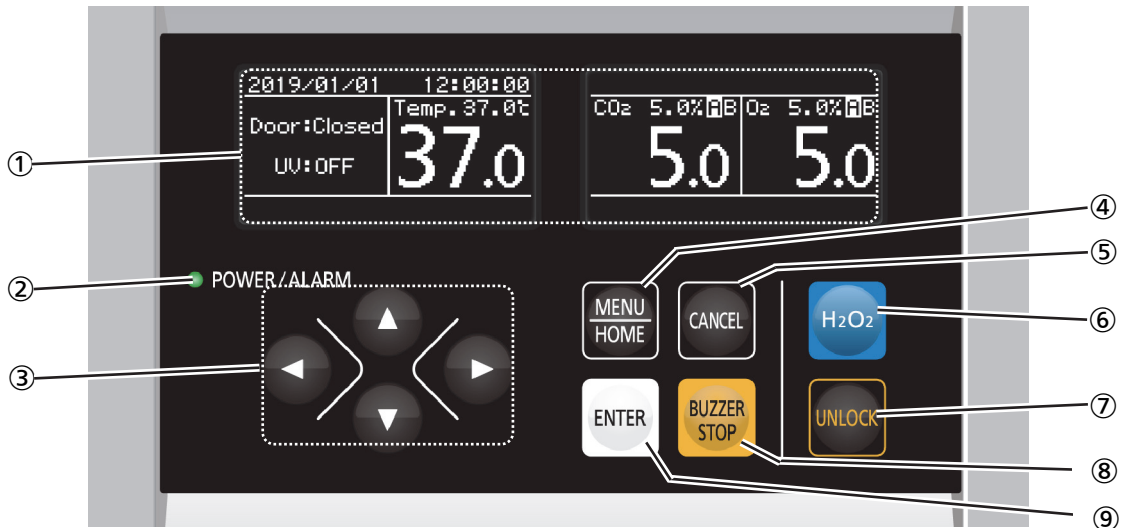

① OLED (Organic Light Emitting Diode) display

Current chamber temperature, CO₂ density, and O₂ density, as well as menu screen and input screens etc. are displayed.

② POWER/ALARM indicator

In normal operation, the green LED lamp lights up, and during alarm condition, the red LED lamp blinks to indicate alarm.

③ Up/down/left/right keys (△▽◀▶)

These keys can move the cursor in the screens other than the home screen.

④ Menu key (MENU/HOME)

On the “home screen”: pressing this key leads the menu screen. It is possible to set various setting on the menu screen.

On the screen “other than the home screen”: pressing this key leads the home screen.

⑤ Cancel key (CANCEL)

On the setting screen, pressing this key switches to the screen of one level up.

⑥ H₂O₂ key (H₂O₂)*¹

This key initiates H₂O₂ decontamination (refer to pages 82–85).

⑦ Unlock key (UNLOCK)*²

This key can unlock the outer door when it is auto-locked by the electric lock (refer to pages 56–57).

⑧ Buzzer stop key (BUZZER STOP)

Pressing this key stops the buzzer.

However, when the ring back is ON, the buzzer will sound again if the alarm state still continues and preset amount of time has elapsed after the BUZZER STOP key was pressed. Refer to pages 68 and 86–90.

Note: You cannot silence the buzzer for the high limit temperature alarm.

⑨ Enter key (ENTER)

Press this key to select the menu item or to accept the values set during the setting procedures.

*1: When the optional UV system set MCO-170UVS, H₂O₂ generator MCO-50HP, H₂O₂ decon kit MCO-50HB and electric lock MCO-170EL are all installed.

*2: When the optional Electric lock MCO-170EL is installed.

INCUBATOR COMPONENTS

Remote alarm terminal

The alarm of this product can be transferred to a remote location by connecting the external alarm unit to the remote alarm terminal. For the behaviour of remote alarm output, refer to pages 86–90.

The terminal of the remote alarm is provided at the back upper right of the unit (see the right figure). The alarm is output from this terminal. Contact capacity is DC 30 V, 2 A.

Table 1 shows the behaviour of the remote alarm when the BUZZER STOP key is pressed.

Notes:

- The door alarm does not work remotely. Refer to pages 89 and 90.
- Wiring of the remote alarm should be performed by qualified service personnel.
- It is recommended to use standard signal and interface cables with a maximum length of 30 meters.

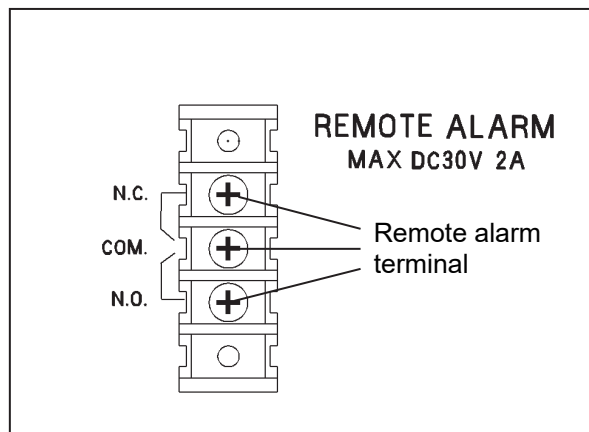

Table 1. Behaviour of remote alarm when pressing BUZZER STOP key

Remote Alarm setting (Refer to pages 61–69)	Connecting terminal	Normal condition	Abnormal condition (Including during the power outage and when power supply cord is disconnected)	
			When pressing the BUZZER STOP key	
ON: Remote alarm setting not linked with BUZZER STOP key	COM.-N.C.	Close	Open	Open (still abnormal) *1
	COM.-N.O.	Open	Close	Close (still abnormal) *1
OFF: Remote alarm setting linked with BUZZER STOP key	COM.-N.C.	Close	Open	Close (Return to normal)
	COM.-N.O.	Open	Close	Open (Return to normal)

*1: In the case of Err01, Err02, Err11, Err12, and Err18, the condition returns to normal.

INSTALLATION

Installation site

For correct operation of the incubator, install it in a location with the following conditions.

- **Normal air environment**

Install the incubator in an environment with normal air.

- **Do not expose to direct sunlight**

Do not install the incubator in a location where it will be exposed to direct sunlight. If the incubator is operated in direct sunlight, performance will be adversely affected.

- **Separate from heat sources**

Do not install the incubator near significant heat sources, such as heaters, boilers, ovens, or autoclaves. Heat will adversely affect the performance of the incubator.

- **Ambient temperature at least 5 °C lower than set temperature**

The control temperature of the incubator is at least 5 °C higher than the ambient temperature. For example, if the chamber is controlled at 37 °C, the ambient temperature must be 32 °C or less. Do not allow the ambient temperature to become too high.

- **Strong and level floor**

Select a site with a strong and level floor. If the floor is uneven or the installation is not level, the incubator will be unstable and this may cause accident or injury. To avoid vibration and noise, always make sure that the installation is stable. An unstable surface may result in vibration or noise.

- **Separate from vibration products**

Do not install the incubator near vibration products. Vibration may cause culture failure.

- **Low humidity**

Select a site with a relative humidity of 80 %R.H. or lower. Using the incubator in high humidity may result in current leakage or electric shock.

- **No inflammable or corrosive gas**

Never install the incubator in a location where it will be exposed to inflammable or corrosive gas. Doing so may result in explosion or fire. In addition, insulation may deteriorate due to corrosion of protective casing, resulting in current leakage or electric shock.

- **No falling objects**

Do not install the incubator in a location where there is the possibility of objects falling from above. Doing so may result in damage or accident.

INSTALLATION

Installation

1. Remove the packing tape and clean up.

Remove all the tapes securing the doors and the inner attachments. Open the doors to ventilate the chamber for a while. If the outer panels are dirty, use a cloth to wipe them with a diluted neutral detergent (Undiluted detergent can damage the plastic components. For the dilution, refer to the instructions on the detergent).

Wipe off the residual detergent with a piece of gauze moistened with water and then wipe off any moisture with a dry cloth.

Note: Remove the cable tie around the power supply cord to prevent corrosion of the cord coating.

2. Remove inner attachments.

(1) Lift the fan cover and pull it toward you to remove it (Fig. 1).

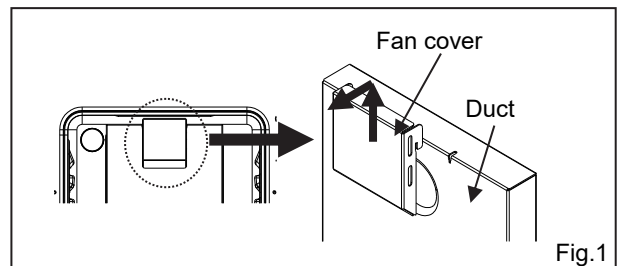

(2) Lift the duct and remove it from the inner pins (Fig. 2).

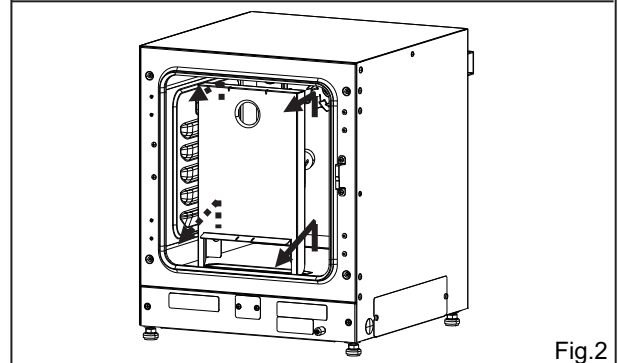

3. Connect the gas injection nozzle.

When controlling O₂ density in the chamber, connect the gas injection nozzle to the gas injection port by using the included gas injection nozzle tube (Fig. 3).

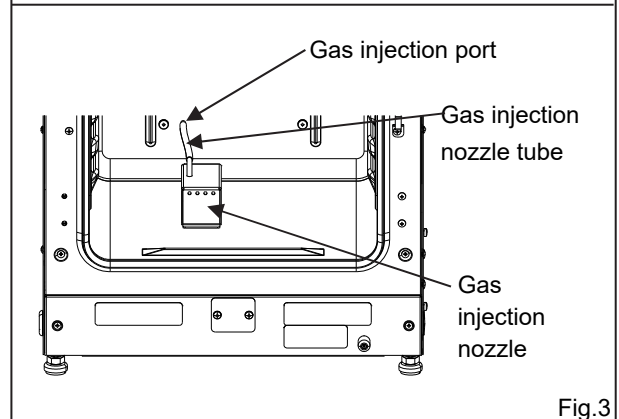

4. Install inner attachment.

(1) Install the duct removed in the above (2) of step 2.

Note: When installing the duct, make sure that the four pins are inserted into the four holes of the duct.

(2) Install the fan cover removed in the above (1) of step 2.

Note: When installing the fan cover, make sure that two upper hooks are inserted into the duct holes.

(3) Install the humidifying pan (Fig. 4).

(4) Install the two trays (Fig. 4).

Note: Position the trays with the front edge bent down.

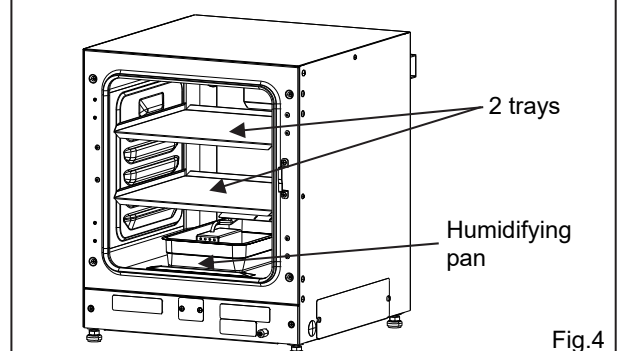

INSTALLATION

5. Adjust the leveling feet.

Adjust the leveling feet by turning them anticlockwise until the incubator is level (Fig. 5).

Note: Incubating on a sloping tray may adversely affect the cultivation.

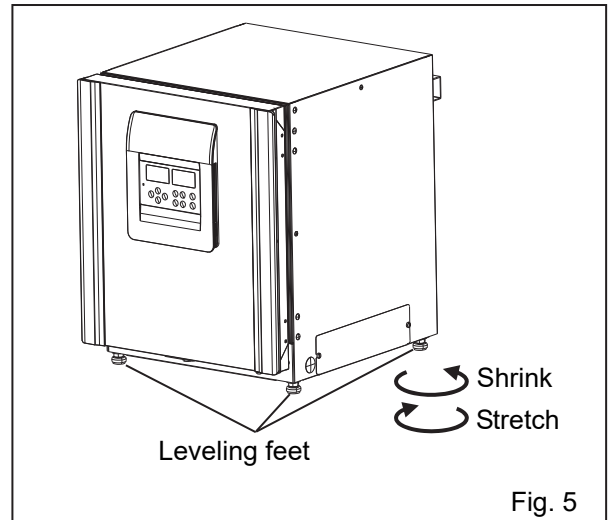

6. Earth the incubator.

Earth the incubator during installation to prevent electric shock. If there is no earth wire at the location, consult with qualified service personnel.

Notes:

• When an earth must be installed

If an earthed 3-pole outlet is not available, then an earth must be installed. Consult with qualified service personnel.

• Installing an earth fault circuit breaker

If you must use the incubator in a moist or humid location, then it is recommended that an earth fault circuit breaker be installed in the power supply circuit (i.e., the power supply at the incubator). Have the circuit breaker installed by qualified service personnel.

7. In case of double stack or triple stack

For stacking the incubators surely, refer to the procedure included with the optional double stacking bracket MCO-170PS or the stacking plate MCO-50SB.

Notes:

• When stacking incubators, fix the upper incubator to the wall by passing a wire or chain through the hooks on the back side of the unit to prevent falling over (Fig. 6).

• When stacking our other CO₂ incubator or O₂/CO₂ incubator with this product (double-stacking or triple-stacking), the brackets/plates to be used vary depending on the combination. Refer to tables 10 and 11 on page 95.

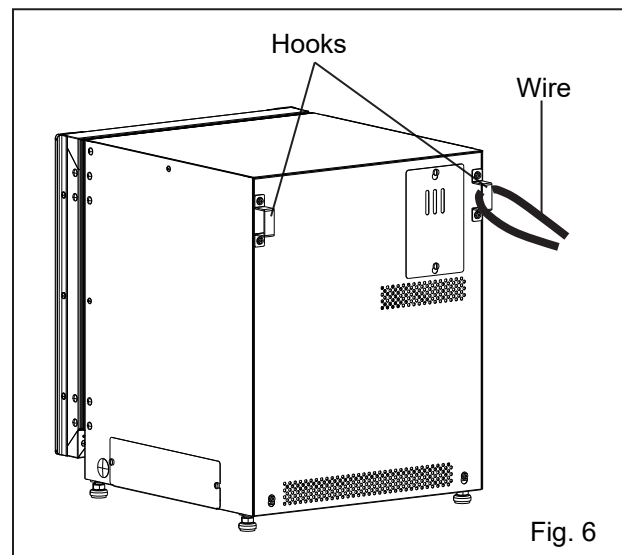

Notes:

• When the incubator is not in use

Empty the water from the humidifying pan and remove moisture from the chamber. Make sure that the chamber is completely dry before closing the doors. Failure to do so may result in damage.

• Before moving the incubator

Before moving the incubator, empty the water from the humidifying pan, disconnect the power supply plug from the outlet, and make sure that the power supply cord will not be damaged. Failure to do so may result in electric shock or fire.

INSTALLATION

Note: Before connecting a CO₂ gas cylinder, read the precautions for safe operation on pages 5–9.

Connecting a CO₂ gas cylinder

1. Prepare a CO₂ gas cylinder and attach the optional gas regulator MCO-010R.

Notes:

- Use a liquefied-CO₂ gas cylinder (at least 99.5 % pure). The siphon (dip tube) type cannot be used.
- When MCO-010R is not available, attach a gas regulator rated at 25 MPa(G) (250 kgf/cm²(G), 3,600 psi(G)) for the primary side, and 0.25 MPa(G) (2.5 kgf/cm²(G), 36 psi(G)) for the secondary side.

2. Connect the connecting port A for the CO₂ gas pipe and the gas regulator for the CO₂ gas cylinder using the included gas tube. When CO₂ gas auto-changer MCO-50GC (optional) is installed, refer to page 75 for the connection.

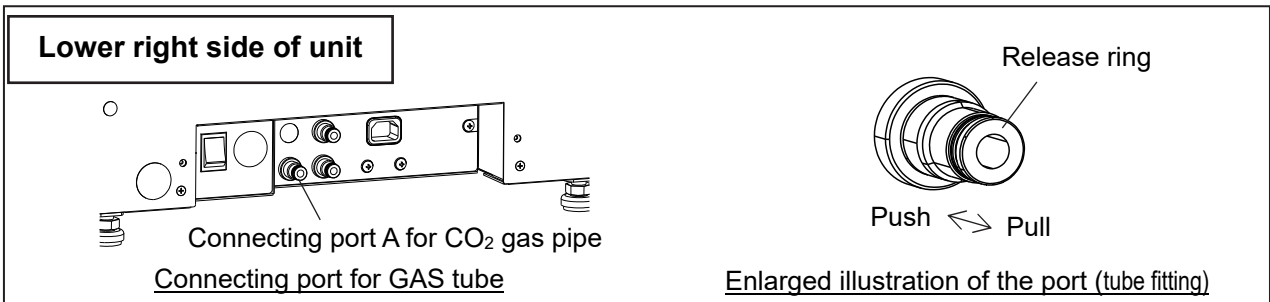

Notes:

- This product employs a tube fitting. Refer to the following steps to attach and remove the tube.
 - (1) Attaching the tube
Insert the tube all the way to the end so that the tube is secured by the inner locking hook and sealed with elastic sleeve around it.
* In order to make sure that the tube is securely attached, pull the tube after connection. If the tube comes off, pull the release ring, and then reconnect the tube and check if it does not become detached.
 - (2) Removing the tube
Disconnect the tube while pressing on the release ring to remove the tube.
- Connecting to the gas regulator (MCO-010R)

<When connecting to the joint for the gas regulator tube>

 - (1) Attach the conversion joint that came with the incubator unit to the gas tube.
 - (2) Connect between the joints using the connection tube, and then secure the connection with the tube bands.

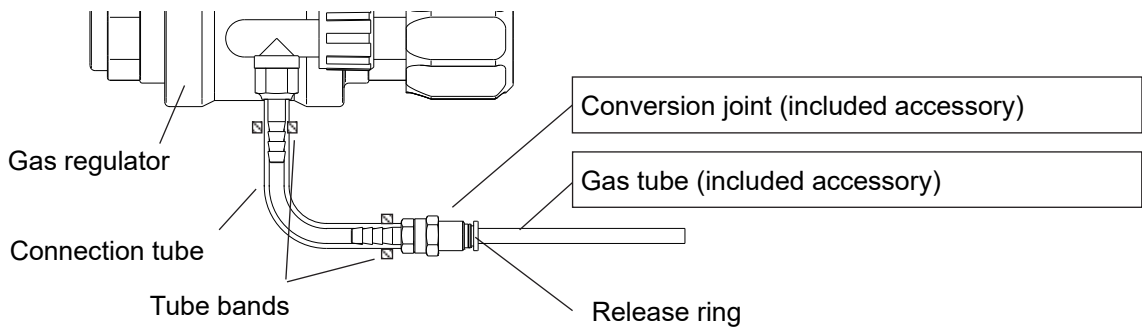

Preparation of parts (Reference)	Connection tube: φ6 inner diameter/soft polyurethane tube Tube bands
----------------------------------	---

INSTALLATION

<When using the tube fitting>

- (1) Remove the hose joint from the gas regulator.
- (2) Attach the conversion bush using the packing or seal tape and then, attach the tube fitting.
- (3) Connect the gas regulator and the incubator using the gas tube that came with the incubator unit.

Note: Wind the seal tape around the thread part only. Make sure that the seal tape does not stick out of the thread.

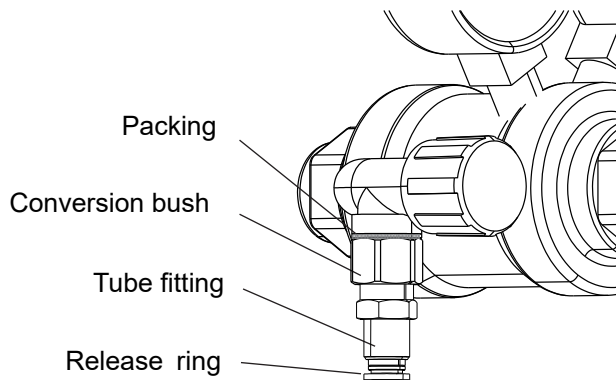

Preparation of parts (Reference)	Tube fitting: female straight, adaptive tube OD6mm, Rc1/8 Conversion bush: bush A M12x1, R1/8 Packing: 6A (ID13mm x OD18mm) or seal tape
----------------------------------	--

Note: If the CO₂ gas is supplied to multiple O₂/CO₂ incubators from a single gas cylinder, a CO₂ solid will be formed in the gas regulator. Then, the gas regulator safety valve will actuate and there may be an explosive sound.

3. After connecting the gas tube, make sure that no gas is leaking (ex. by using a gas leak detector spray).

4. Set the CO₂ gas on the secondary side to 0.03 MPa(G)–0.1 MPa(G) (0.3 kgf/cm²(G)–1 kgf/cm²(G), 4.4 psi(G)–14.5 psi(G)) for gas injection. Recommended pressure: 0.03 MPa(G) (0.3 kgf/cm²(G), 4.4 psi(G)).

Note: Do not set the pressure on the secondary side too high. As the pressure increases, the CO₂ gas density will vary widely. Excessive pressure may cause gas supply lines inside the incubator to come loose, which may result in gas poisoning or oxygen deprivation due to leaking gas. If gas lines come loose, the incubator must be repaired.

5. When there is no CO₂ gas left and the CO₂ gas empty alarm is activated, replace the empty gas cylinder.

Note: When the optional gas auto-changer MCO-50GC is installed, it automatically switches the empty CO₂ gas supply line to the other. Refer to pages 75–76.

Notes:

- The gas lines connected to the incubator will degrade over time. If any deterioration or abnormalities are found during inspection, replace the lines immediately.
- Close the valve of the CO₂ gas cylinder when the CO₂ gas is not in use.

INSTALLATION

Note: Before connecting N₂ gas cylinders (or O₂ gas cylinders), read the precautions for safe operation on pages 5–9.

Connecting N₂/O₂ gas cylinders

Depending on the setting of O₂ density, the N₂ or O₂ gas cylinder should be selected. The selection is as follows:

- When the setting of O₂ density is 18 % or less: N₂ gas
- When the setting of O₂ density is 22 % or more: O₂ gas

O₂ density in the atmosphere is about 20 %. For the control of O₂ density in the chamber, O₂ gas is diluted by N₂ gas when the setting of O₂ density is less than that of the atmosphere. On the contrary, O₂ gas is added when the setting of O₂ density is more than that of the atmosphere.

1. Prepare two N₂ gas cylinders (or two O₂ gas cylinders) and attach optional gas regulators MCO-010R to each cylinder.

Note: When MCO-010R is not available, attach a gas regulator rated at 25 MPa(G) (250 kgf/cm²(G), 3,600 psi(G)) for the primary side, and 0.25 MPa(G) (2.5 kgf/cm²(G), 36 psi(G)) for the secondary side.

2. Connect the connecting port A for the N₂/O₂ gas pipe and the gas regulator of the N₂ gas cylinder A (or the O₂ gas cylinder A) using the included gas tube.

3. Using the gas tube provided, connect the connecting port B for the N₂/O₂ gas pipe and the gas regulator of the N₂ gas cylinder B (or the O₂ gas cylinder B).

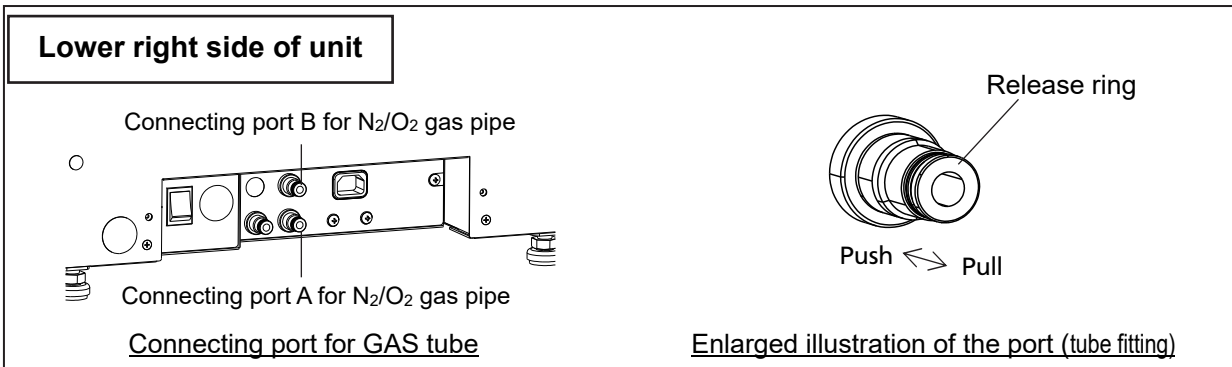

Notes:

- The type of gas from the two gas cylinders must be the same one. It is not possible to use an N₂ gas cylinder and an O₂ gas cylinder simultaneously.
- For connecting/removing the tube and for connecting to the gas regulator MCO-010R, refer to pages 19-20.

4. After connecting the gas tube, make sure that no gas is leaking (ex. by using a gas leak detector spray).

5. Set the N₂ gas (or the O₂ gas) on the secondary side to 0.05 MPa(G)–0.1 MPa(G) (0.5 kgf/cm²(G)–1 kgf/cm²(G), 7.3 psi(G)–14.5 psi(G)) for gas injection.

Recommended pressure: 0.05 MPa(G) (0.5 kgf/cm²(G), 7.3 psi(G)).

Note: Do not set the pressure on the secondary side too high. As the pressure increases, the O₂ gas density will vary widely. Excessive pressure may cause gas supply lines inside the incubator to come loose, which may result in fire or oxygen deprivation due to leaking gas. If gas lines come loose, the incubator must be repaired.

6. When there is no N₂ gas (O₂ gas) left, the incubator automatically switches the empty N₂ gas (O₂ gas) supply line to the other.

Note: The gas lines connected to the incubator will degrade over time. If any deterioration or abnormalities are found during inspection, replace the lines immediately.

BEFORE STARTING OPERATION

Initial cleaning method

Before using the incubator for the first time, always thoroughly clean the chamber, inner attachments and humidifying pan (accessory) to remove dirt (tape residue, oil, etc.). Cleaning the chamber and humidifying pan is essential to ensure the utmost performance of the incubator. Use the following steps to properly clean the incubator.

1. Remove the inner attachments, referring to “Removing inner attachments” on pages 23-24.
2. Put on rubber gloves, and then disinfect the surface of the rubber gloves with alcohol for disinfection.
3. Thoroughly wipe clean the inner walls of the chamber, the inner attachments, the temperature sensor, the humidity control bar, and the UV lamp using gauze moistened with a proper amount*¹ of alcohol for disinfection (Fig. 1). Make sure to take particular care in cleaning corners and joints of the product.
4. Thoroughly wipe clean the inner door, inner door packing, and handles using gauze moistened with a proper amount*¹ of alcohol for disinfection.
5. Thoroughly wipe clean the removed inner attachments using gauze moistened with a proper amount*¹ of alcohol for disinfection, and then reinstall the inner attachments correctly and securely, referring to “Installing inner attachments” on page 25.
6. Thoroughly wipe clean the surface of the humidifying pan (accessory) using gauze moistened with a proper amount*¹ of alcohol for disinfection.

*¹ The amount that cannot form droplets on the surface.

Note: The most effective procedure to prevent contamination is to clean each part with a cloth or sponge moistened with a neutral cleaning solvent diluted to 5% or less, and then wipe down each part with gauze moistened with distilled water. You can also use autoclave sterilization (121°C for 20 minutes) for the silicon caps of the measurement ports (2 pcs) and the fan.

Do not use acidic, alkaline or chlorine solvents or disinfectants. Use of these solutions may cause discoloration, corrosion or rust.

Be careful that solutions such as alcohol for disinfection do not come in contact with the ① CO₂ sensor, ② fan motor shaft bearing, ③ CO₂ gas injection port, ④ temperature sensor, ⑤ chamber sample air measurement port, ⑧ O₂ gas injection port, and ⑨ inner sample air access port. Furthermore, do not clean the ⑥ humidity control bar and the ⑦ UV lamp using cleaning solvents. Use of these solutions may cause damage. (Fig. 2)

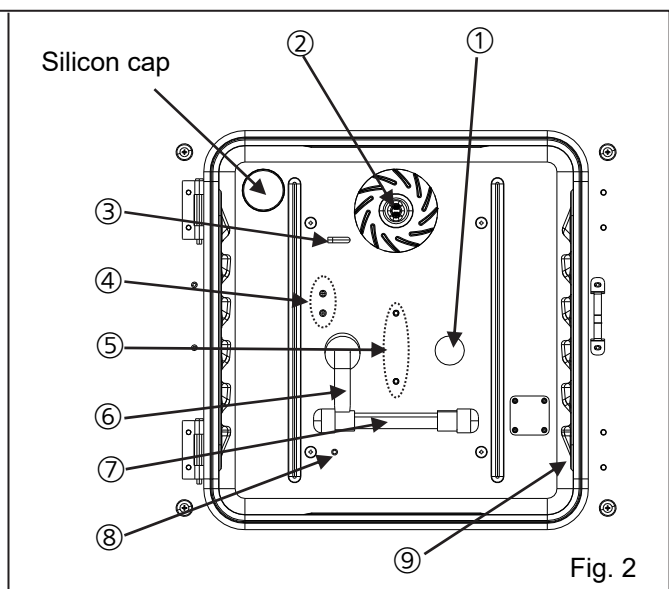
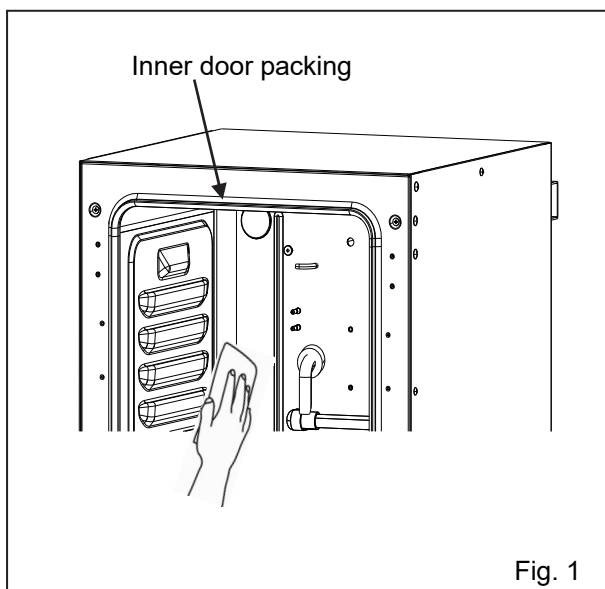

BEFORE STARTING OPERATION

Removing inner attachments

Remove the inner attachments through the following procedure.

Be careful not to damage the UV lamp in the duct (When an optional UV system set MCO-170UVS is installed).

1. Turn OFF the power to the incubator.
2. Open the outer and inner doors and pull out all the trays (Fig.1).

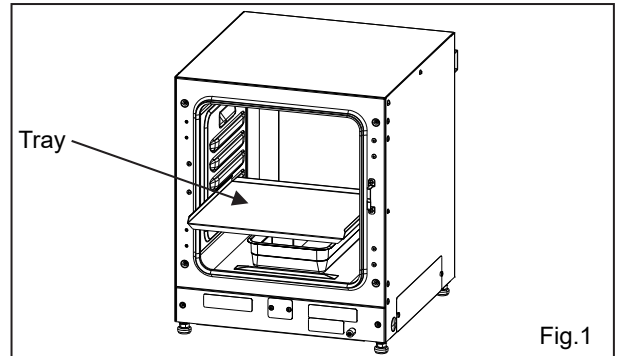

3. Lift the fan cover and pull it toward you to remove it (Fig.2).

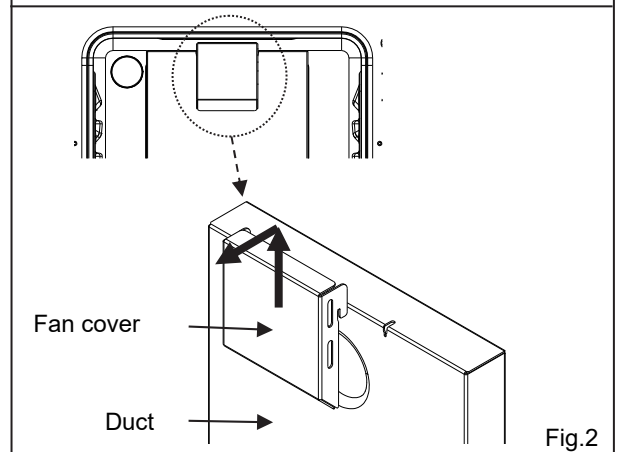

4. Lift the duct and remove it from the inner pins (Fig.3).

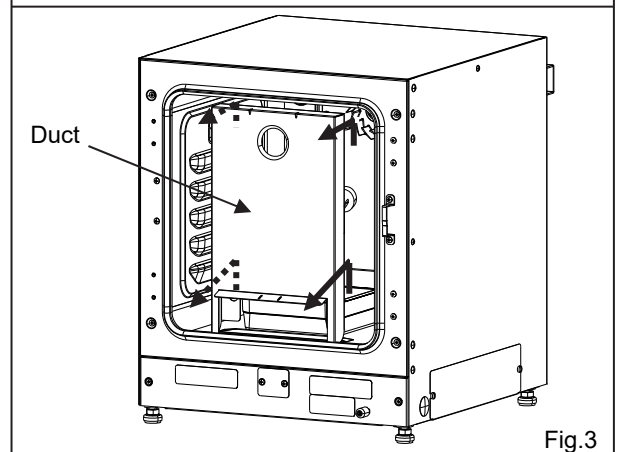

5. Pull out the humidifying pan (Fig. 4)

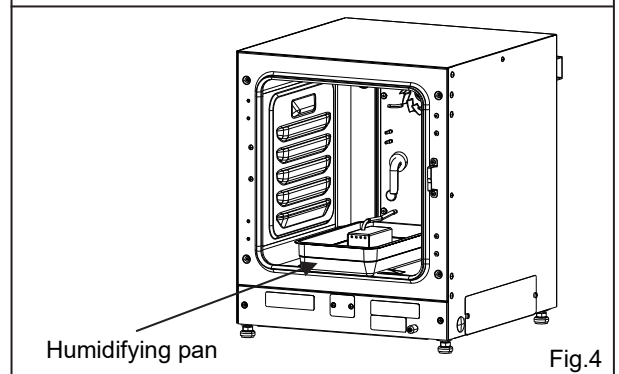

BEFORE STARTING OPERATION

6. Pull out the gas injection nozzle and gas injection nozzle tube (Fig.5).

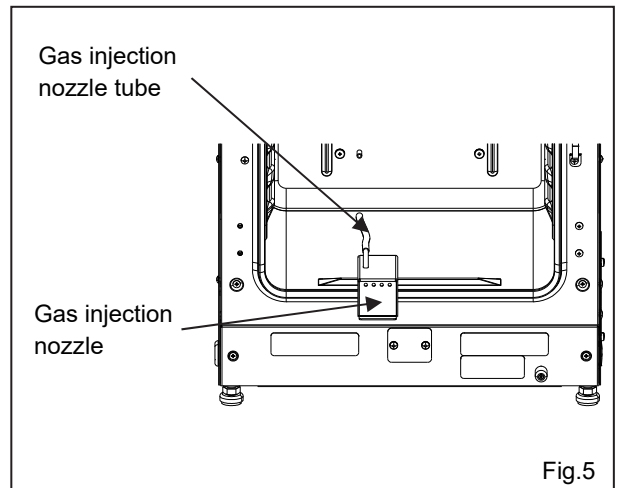

Fig.5

7. Pull out the fan (Fig. 6).

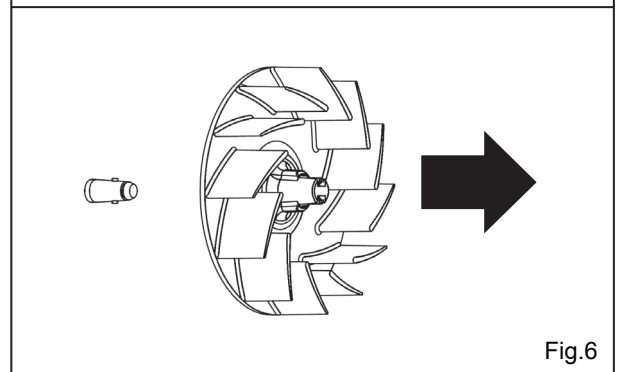

Fig.6

8. Remove the silicon caps for the access port from the interior and exterior (Fig.7 and Fig.8).

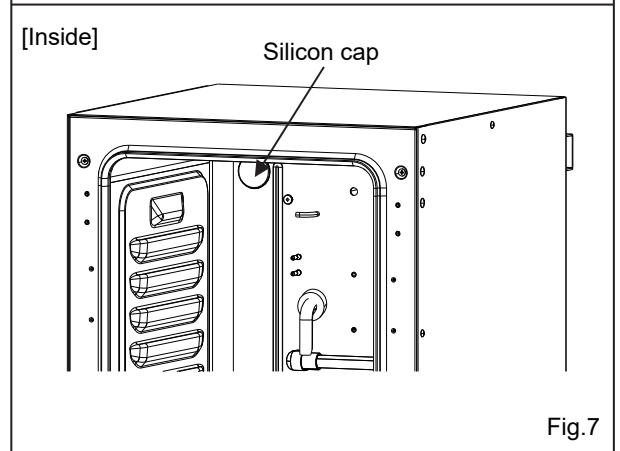

Fig.7

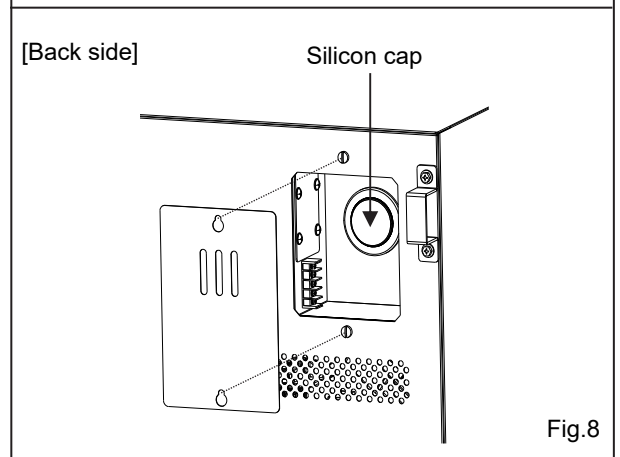

Fig.8

BEFORE STARTING OPERATION

Installing inner attachments

To reinstall all the attachments, perform the procedure in reverse order from step 8 on page 24.

If the attachments are not inserted deep enough, the intended wind velocity performance cannot be achieved, and it may cause culture failure or insufficient decontamination.

Note: When installing the fan, attach it to the motor shaft securely. Manually turn the fan lightly to check that it does not touch the rear wall and pull the fan lightly to check that it is firmly secured (Fig. 1).

Note: When installing the duct, check that 4 pins (Figure below ➡) are securely attached in the 4 holes of the duct (Fig. 2).

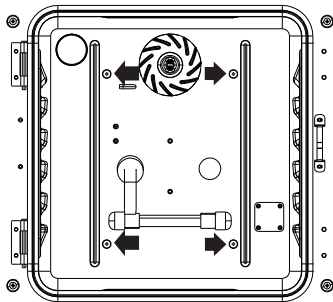

Note: When attaching the fan cover, check that two hooks on the top of the fan cover are securely inserted in the duct holes (Fig. 3).

Note: Position the tray with the front edge bent down (Fig. 4).

1. Position the center hole of the fan over the projection of the motor shaft and push it fully in.

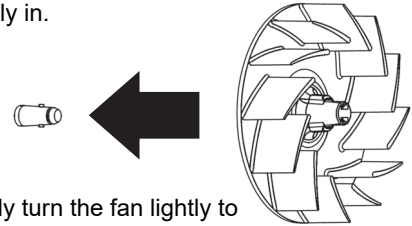

2. Manually turn the fan lightly to check that it does not touch the rear wall.

3. Pull the fan lightly to check that it does not come off.

Fig. 1

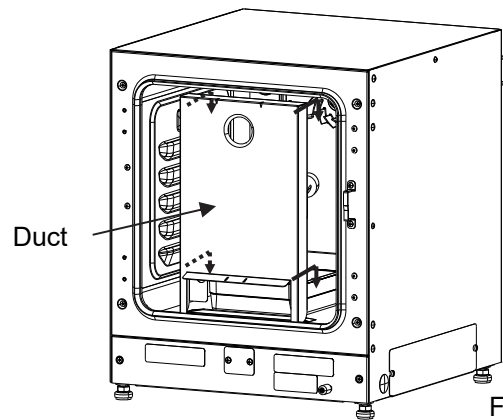

Fig. 2

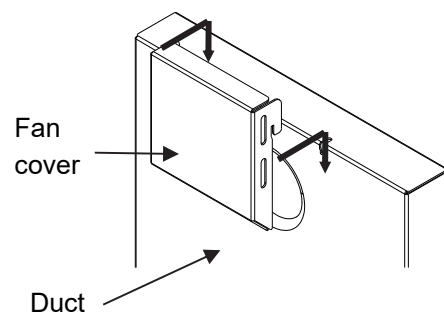

Fig. 3

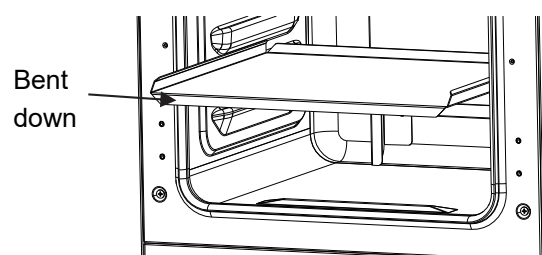

Fig. 4

BEFORE STARTING OPERATION

Filling the humidifying pan

Use the following procedure to fill the humidifying pan with water or to replace water in it.

1. Pull out the humidifying pan (Fig. 1).

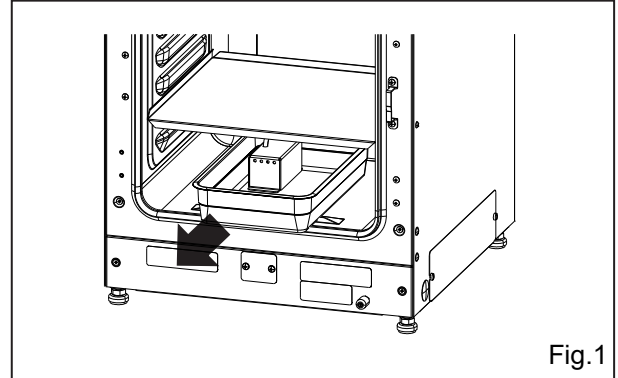

Fig.1

2. Dispose of the remaining water and clean the humidifying pan with a diluted detergent. Then rinse it thoroughly with distilled water and wipe it using alcohol for disinfection.

3. Wipe all moisture from the bottom of the chamber.

4. Return the humidifying pan to the chamber and pour sterile distilled water (approx. 1.5 L, preheated to 37 °C) (Fig. 2).

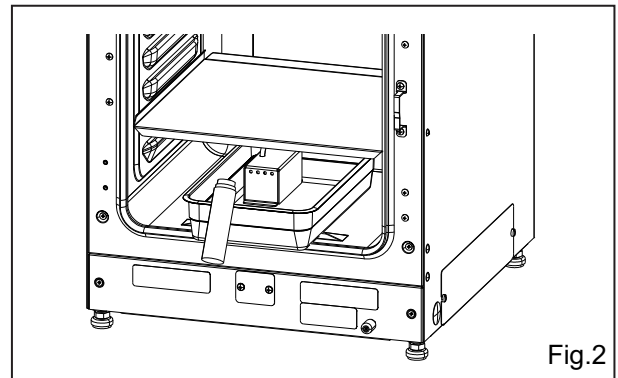

Fig.2

5. Place the humidifying pan flush against the rear wall in the chamber, and close the inner and outer doors.

Notes:

- Operation without water in the humidifying pan may temporarily increase the chamber temperature, resulting in higher temperature than the set temperature.
- Preheat the water to 37 °C. Adding cool water will lower the temperature and humidity in the chamber.
- Install the humidifying pan in a longitudinal direction with its shorter side placed at the back.
- Refill the humidifying pan with water promptly when the volume of water decreases.
- Mixing any reagent into the water for humidifying may have an adverse effect on the cultivation. Do not add any reagent to the water particularly when using the UV lamp since the UV light may cause the mixture to deteriorate.
- After cleaning, change the water in the humidifying pan. The alcohol may influence the correct control of the operation.
- The humidity control bar in the duct is always kept in low temperature and the moisture in the chamber is recondensed. Slide the humidifying pan down right under the humidity control bar, otherwise the recondensed water droplets will fall directly to the bottom of the chamber and form a pool.
- When the pooled water evaporates, it may leave a white mark on the bottom. This is not abnormal. Wipe it off with a piece of gauze or unwoven cloth moistened with alcohol for disinfection. If the mark cannot be removed, scrub it off using a cleansing cream.

FOR OPTIMAL CULTIVATION

Precautions for cultures

- **Leave space between culture containers.**

Always leave space for ventilation between culture containers (petri dishes, flasks, etc.). Inadequate spacing may result in uneven temperature distribution, CO₂ gas density, and O₂ gas density.

- **Do not place harmful materials in the chamber.**

Never place samples that release acidic, alkaline, or corrosive gas into the chamber. Doing so may cause damage resulting from discoloration or corrosion.

- **Close the inner door.**

Always close the inner door before closing the outer door. Failure to close the inner door will adversely affect performance even if the outer door is closed.

- **Open and close the doors gently.**

Closing the doors forcefully may cause spillage of the culture medium, incomplete door closing, or damage to the gasket. Also, before opening the inner door, check through the glass to confirm that the UV lamp is OFF (When an optional UV system set MCO-170UVS is installed).

- **Be careful when closing the outer door.**

Use the handle when closing the outer door. Not doing so may cause injury by getting fingers caught in the door. Do not lean on the outer door. Doing so may result in injury from the outer door coming loose or the incubator falling over, or may cause current leakage or electric shock.

- **Be careful of the inside of the outer door.**

The inside of the outer door may become hot.

- **Avoid using excessive force on the inner door.**

Do not put your hand on the glass, poke it with sharp objects, or apply strong force. Doing so may result in injury from breaking the glass.

- **Check the cause of any alarm buzzer.**

If an alarm buzzer sounds while the incubator is in use, check the cause of the alarm immediately. For details on what may cause an alarm buzzer to sound, refer to pages 86–89.

- **Vibration of a shaker.**

When incubators are stacked, operation of a shaker in one chamber of the O₂/CO₂ incubator may adversely affect the other incubator.

FOR OPTIMAL CULTIVATION

Preventing contamination

To prevent contamination of the chamber, select a suitable installation site.

- **Avoid locations with high temperatures or humidity** where the air may contain more microorganisms.
 - **Do not place the incubator near doors, air conditioners, fans, etc,** where draughts and passage of people may increase the risk of microorganisms entering the chamber.
 - **If possible, use a cleanroom.**
 - **Use clean containers.** Dirty containers are the greatest cause of contamination for cultures. Be careful not to get containers or trays dirty when taking them in and out.
 - **Keep the chamber clean.** Wipe off any fingerprints. If water spills from the humidifying pan, or if the doors are left open for a long time, condensation may form on the inside of the doors. Wipe off condensation with a piece of dry sterile gauze. In particular, if the culture medium is spilled, clean and disinfect the chamber immediately.
 - **Use sterile distilled water in the humidifying pan and change it once a week.** Do not use ultrapure water, which may cause red rust-like particles in the humidifying pan. Clean the humidifying pan once a month.
 - **Keep the incubator out of direct airflows from air conditioners or fans.** Cool airflow from an air conditioner may cause condensation and lead to possible contamination.
- * Condensation caused by the installation environment may be improved by changing the setting of the unit. Contact our sales representative or service personnel.

CORRECT OPERATION

Use the following procedure to start trial operation or actual operation of the incubator.

1. Install the incubator correctly, referring to pages 16–21.
2. Remove the packing materials from the chamber and inner attachments. Then, clean and disinfect the chamber and all the inner attachments, referring to page 22.
3. Add approximately 1.5 L of sterile distilled water to the humidifying pan (refer to page 26).
4. Connect the removable power supply cord to the port on the lower right side.
5. Connect the removable power supply cord to the outlet.
6. Turn ON the power switch on the lower right side of the incubator.
7. Attach the power supply cord cover plate, and then fix the switch cover.

Note: Use the power supply cord included with this product. Do not use other power supply cord. The included removable power supply cord is only for this product. Never use it for any other products.

HOME SCREEN

The display consists of two parts (right side and left side).

When the power is switched ON, the screen called "home screen" that shows the internal temperature, CO₂ density, O₂ density etc. is displayed.

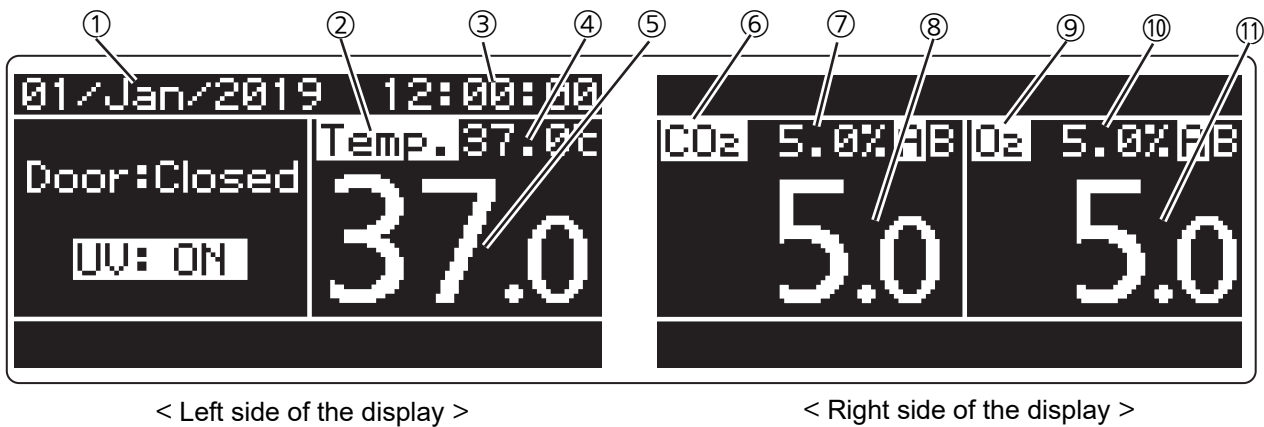

① Date display area

Displays the current date (see pages 78–79 for setting instructions).

② Heating indicator

Highlighted when the heater is on.

③ Time display area

Displays the current time (see page 80 for setting instructions).

④ Set temperature display area

Displays the value set for the temperature in the chamber (see page 34 for setting instructions).

⑤ Current temperature display area

Displays the current temperature value in the chamber. It blinks when the current value of the internal temperature exceeds the set temperature warning range.

⑥ CO₂ gas injection indicator

Highlighted when CO₂ gas is being injected into the chamber.

⑦ Set CO₂ density level display area

Displays the set CO₂ density in the chamber (see page 36 for setting instructions).

If the CO₂ gas control is set to OFF, it displays "OFF".

⑧ Current CO₂ density display area

Displays the current CO₂ density value in the chamber. The value is not displayed if the CO₂ control setting is set to OFF.

It blinks if the CO₂ control is set to ON and the current CO₂ density in the chamber deviates from the CO₂ control range.

⑨ O₂ gas injection indicator

Highlighted when O₂ gas (N₂ gas) is being injected into the chamber.

⑩ Set O₂ density level display area

Displays the set O₂ density in the chamber (see page 38 for setting instructions).

If the O₂ control is set to OFF, it displays "OFF".

⑪ Current O₂ density display area

Displays the current O₂ density value in the chamber. It is not displayed if the O₂ control is set to OFF.

It blinks if the O₂ control is set to ON and the current O₂ density in the chamber deviates from the O₂ control set range.

HOME SCREEN

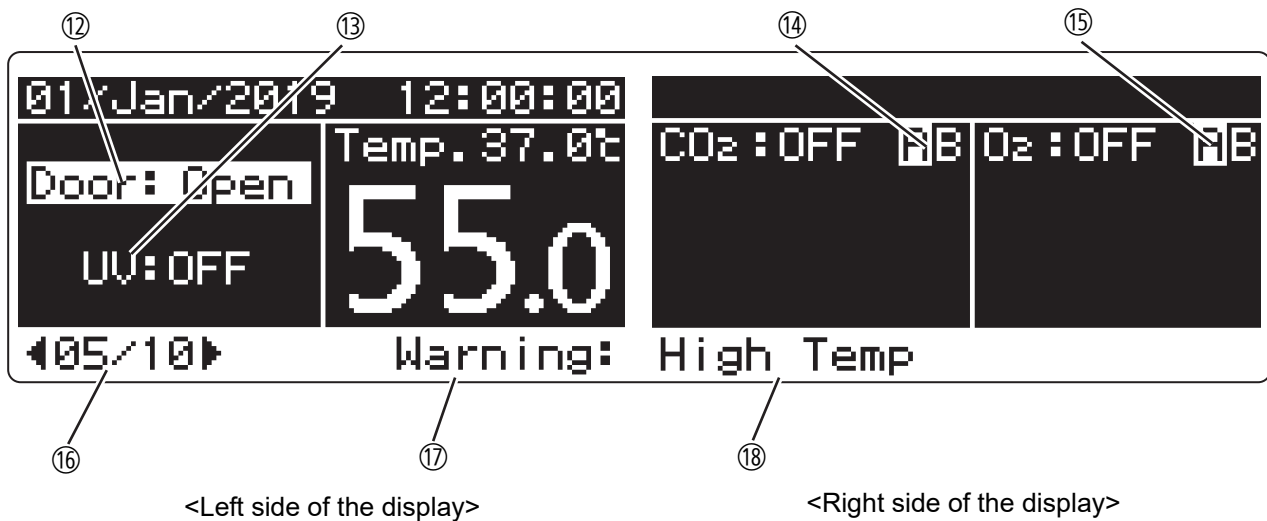

⑫ Outer door status display area

Open: "Door:Open" is highlighted.
 Closed: "Door:Closed" is displayed.
 Locked: "Door:Lock" is displayed. *1

⑬ UV lamp status display area

This area is available when the optional UV lamp is used.
 When UV lamp is ON: "UV:ON" is highlighted.
 When UV lamp is OFF: "UV:OFF" is displayed.

⑭ CO₂ gas supply line indicator A and B

When the optional gas auto changer is used, the CO₂ gas supply line (CO₂ gas pipe connection port) currently in use is highlighted.
 It blinks when the CO₂ cylinder is empty (see pages 75–76 for reference).

⑮ O₂ gas (N₂ gas) supply line indicator A and B

The O₂ gas (N₂ gas) supply line (O₂ gas pipe connection port) currently in use is highlighted.
 It blinks if the O₂ cylinder (N₂ cylinder) is empty (see page 40 for reference).

⑯ Message count display area

When the total number of messages is 1 or more, the number is displayed.
 The display shows the "message number currently displayed in the screen/total number of the messages".
 When the left/right marks (◀▶) are displayed, you can see the other messages using the left and right keys.

⑰ Error/warning display area

Displays the current error/warning (see pages 86–89).
 If there is an error: "Err XX" (XX is the error code) will be displayed.
 If there is a warning: "Warning" will be displayed.

⑱ Message display area

Error/warning/other message is displayed (see pages 86–89).

Notes:

When the unit meets the following all conditions, the display automatically starts scrolling from right to left.

- Not in an alarm condition (no error messages are displayed).
- The display areas for temperature, CO₂ density, and O₂ density are not blinking.
- The outer door is closed.
- No keys have been pressed for 30 seconds or more.

Scrolling can be stopped in either one of the following conditions.

- In an alarm condition (error messages are displayed).
- Either of the current temperature, CO₂ density, and O₂ density display area is blinking.
- The outer door is opened.
- Any key is pressed.

*1: When an optional UV system set MCO-170EL is installed.

MENU SCREEN

While the home screen is displayed, pressing the menu key (MENU/HOME) displays the Menu screen on the left side. The Menu screen consists of the following items:

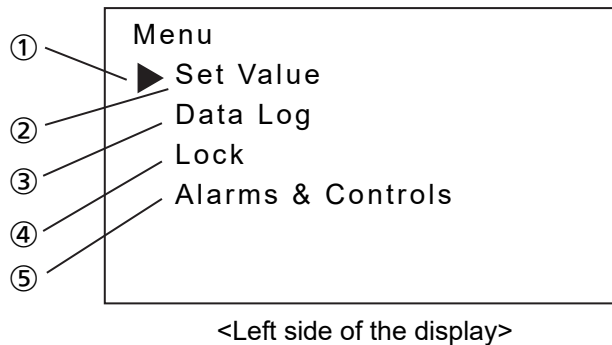

① Cursor

Used when selecting the menu items. You can move the cursor using the up and down keys (Δ ∇).

② Chamber temperature/CO₂ density/O₂ density/high limit temperature alarm setting

Select to change the settings of the chamber temperature/CO₂ density/O₂ density/high limit temperature alarm. Move the cursor to this item and press the enter key (ENTER) to go to the setting screen.

③ Log display/output

Select this when displaying various log data on the screen or to export it to a USB flash drive. Move the cursor to this item and press the enter key (ENTER) to go to the Data Log screen.

④ Key lock/Door lock*¹ settings

Select this when changing key lock/Door lock settings. Move the cursor to this item and press the enter key (ENTER) to go to the Lock screen.

✧The key lock can be set to prevent the setting from being incorrectly changed. If set to ON, the settings cannot be changed even if the keys on the control panel are pressed.

⑤ Alarm settings and other settings

Select for changing alarm settings or other settings. Move the cursor to this item and press the enter key (ENTER) to go to the Alarms & Controls screen.

*1: When an optional Electric lock MCO-170EL is installed.

MENU SCREEN

Following shows the screen display and function at each screen under Menu level.

Note: The unit will return from setting mode to the home screen automatically after 90 seconds if no key is operated (auto-return function). In this case, the setting is not changed.

Screen	Function	Page
Set Value screen		
Temperature	(Setting) chamber temperature	34
CO ₂ ON/OFF	(Setting) CO ₂ gas control mode	35
CO ₂ Setting	(Setting) CO ₂ density	36
O ₂ ON/OFF	(Setting) O ₂ gas control mode	37
O ₂ Setting	(Setting) O ₂ density	38
Overtemp	(Setting) high limit temperature alarm	39
Data Log screen		
Data Log Chart	(Display) operation log graph (can be exported)	42–44
Data Log Export	(Export) operation log	45–46
Data Log Setting	(Setting) log interval, Unique ID	47–48
Alarm	(Display) alarm log	49
Alarm Export	(Export) alarm log	50–51
Lock screen		
Keypad Lock	(Setting) Key lock ON/OFF, password	52–53
Door Lock* ¹	(Setting) Door lock ON/OFF, password	54–60
Alarms & Controls screen		
Temp/Gas Alarm Set screen		
Temp Alarm	(Setting) temperature alarm	61
Temp Alarm Delay	(Setting) temperature alarm delay	62
CO ₂ Alarm	(Setting) CO ₂ density alarm	63
CO ₂ Alarm Delay	(Setting) CO ₂ density alarm delay	64
O ₂ Alarm	(Setting) O ₂ density alarm	65
O ₂ Alarm Delay	(Setting) O ₂ density alarm delay	66
Other Alarm Set screen		
Door Alarm Delay	(Setting) door alarm delay	67
Ring Back Delay	(Setting) ring back delay	68
Remote Alarm	(Setting) remote alarm	69
UV Setting* ²		
UV Lighting Time	(Setting) UV lamp ON period	71
UV Life Counter	(Display) UV lamp life indication	72
Auto-Extended Time	(Display) Automatic extension of UV lamp ON period	73
UV 24h Mode Start	(Setting) Lighting UV lamp for 24 hours	74
Gas Supply Setting		
CO ₂ Supply* ³	(Setting) Manual CO ₂ gas supply line A/B switching	77
N ₂ /O ₂ Supply	(Setting) Manual N ₂ /O ₂ gas supply line A/B switching	41
Date & Time screen		
Date Format	(Setting) date display format	78
Date	(Setting) date	79
Time	(Setting) time	80
Keypad Click Set screen		
Keypad Click Set	(Setting) keypad clicking sound	81
DAQ Setting screen* ⁴	Don't push (Only for MTR-5000 user)	—
Calibration screen* ⁵	Don't push (Qualified engineer only)	—

*1: When an optional Electric lock MCO-170EL is installed.

*2: When an optional UV system set MCO-170UVS is installed.

*3: When an optional gas auto changer MCO-50GC is installed.

*4: Only when using an optional software product Data acquisition system MTR-5000.

*5: Service key is not available. (Qualified engineer only)

BASIC PARAMETERS

Setting temperature

The chamber temperature during the normal operation of the incubator can be set as follows. The incubator automatically starts operation using these settings after power-on.

- Settable range: 0.0 °C – 50.0 °C
- Factory setting: 37.0 °C

1. On the home screen, press the menu key (MENU/HOME).

▶ The left side of the display changes to the Menu screen.

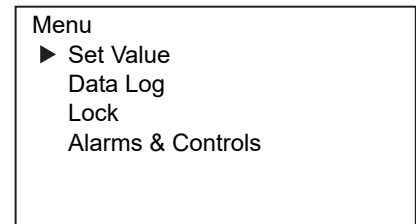

<Left side of the display> [Fig. 1]

2. When the cursor on the menu screen is on Set Value [Fig. 1], press the enter key (ENTER).

▶ The display changes to the Set Value screen.

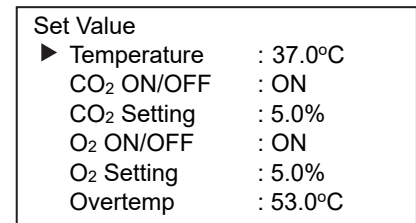

<Left side of the display> [Fig. 2]

3. When the cursor on the Set Value screen is on Temperature [Fig. 2], press the enter key (ENTER).

▶ The right side of the display changes to the Temperature screen, and the current set value (37.0) is displayed [Fig. 3].

4. Move the cursor using the left/right keys (◀▶) and select the digit you want to change, and then use the up/down keys (▲▼) to change the number.

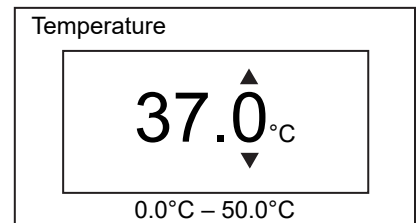

<Right side of the display> [Fig. 3]

5. Press the enter key (ENTER).

▶ The value is confirmed and the display returns to the Set Value screen.

*If the entered setting value is out of the settable range, the following message is displayed on the right side of the display. Press any key on the control panel to change to the Temperature screen [Fig. 3].

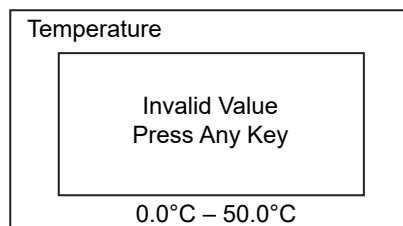

<Right side of the display>

6. Press the menu key (MENU/HOME) to display the home screen.

◇The display returns to the home screen automatically when 90 seconds has passed without any key operation.

BASIC PARAMETERS

Setting CO₂ gas

The CO₂ gas control mode during the normal operation of the incubator can be set as follows. The incubator automatically starts operation using these settings after power-on.

- Setting values: ON or OFF
- Factory setting: OFF

1. On the home screen, press the menu key (MENU/HOME).
▶ The left side of the display changes to the Menu screen.

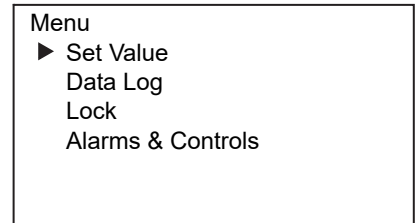

<Left side of the display> [Fig. 1]

2. When the cursor on the menu screen is on Set Value [Fig. 1], press the enter key (ENTER).

▶ The display changes to the Set Value screen.

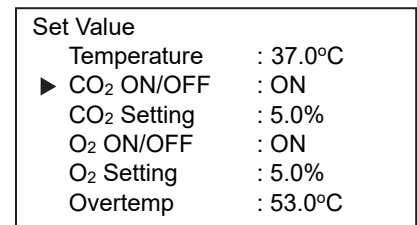

<Left side of the display> [Fig. 2]

3. On the Set Value screen, move the cursor to CO₂ ON/OFF [Fig. 2] using the up/down keys (△▽), and press the enter key (ENTER).

▶ The left side of the display changes to the CO₂ ON/OFF screen, and the current set value (ON) is displayed [Fig. 3].

4. Use the up/down keys (△▽) to change the control setting value.

◇ Each time the up/down key is pressed the value changes between ON and OFF.

5. Press the enter key (ENTER).

▶ If it is set to ON: the value is confirmed and the display changes to the CO₂ Setting screen.

If it is set to OFF: the value is confirmed and the display changes to the Set Value screen.

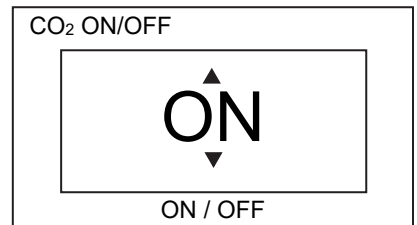

<Right side of the display> [Fig. 3]

6. Press the menu key (MENU/HOME) to display the home screen.

◇ The display returns to the home screen automatically when 90 seconds has passed without any key operation.

BASIC PARAMETERS

Setting CO₂ density

The CO₂ density during the normal operation of the incubator can be set as follows. The incubator automatically starts operation using these settings after power-on.

- Settable range: 0.0 % – 20.0 % (When the setting is 0.0 %, the CO₂ ON/OFF becomes “OFF”)
- Factory setting: OFF

Note: When operating the incubator for the first time or after not using it for an extended period of time, set the chamber temperature to the desired temperature and set CO₂ ON/OFF and O₂ ON/OFF to “OFF”, then operate it for at least about 4 hours until the chamber temperature and the CO₂/O₂ sensors become stable. After that, change the setting to the desired CO₂ density.

1. On the home screen, press the menu key (MENU/HOME).

▶ The left side of the display changes to the Menu screen.



<Left side of the display> [Fig. 1]

2. When the cursor on the menu screen is on Set Value [Fig. 1], press the enter key (ENTER).

▶ The display changes to the Set Value screen.

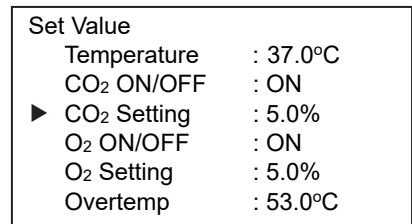

<Left side of the display> [Fig. 2]

3. On the Set Value screen, move the cursor, to CO₂ Setting [Fig. 2] using the up/down keys (△▽), and press the enter key (ENTER).

▶ The right side of the display changes to the CO₂ Setting screen, and the current setting value (05.0) is displayed [Fig. 3].

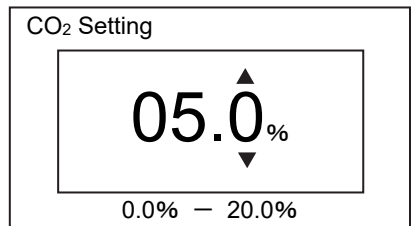

<Right side of the display> [Fig. 3]

4. Move the cursor using the left/right keys (◀▶) and select the digit you want to change, and then use the up/down keys (△▽) to change the number.

5. Press the enter key (ENTER).

▶ The value is confirmed and the display returns to the Set Value screen.

*If the entered setting value is out of the settable range, the following message is displayed on the right side of the display. Press any key on the control panel to change to the CO₂ Setting screen [Fig. 3].

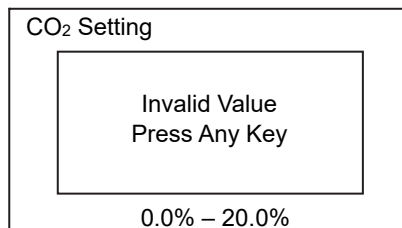

<Right side of the display>

6. Press the menu key (MENU/HOME) to display the home screen.

✧The display returns to the home screen automatically when 90 seconds has passed without any key operation.

BASIC PARAMETERS

Setting O₂ gas

The O₂ gas control mode during the normal operation of the incubator can be set as follows. The incubator automatically starts operation using these settings after power-on.

- Setting values: ON or OFF
- Factory setting: OFF

1. On the home screen, press the menu key (MENU/HOME).

▶ The left side of the display changes to the Menu screen.



<Left side of the display> [Fig. 1]

2. When the cursor on the menu screen is on Set Value [Fig. 1], press the enter key (ENTER).

▶ The display changes to the Set Value screen.

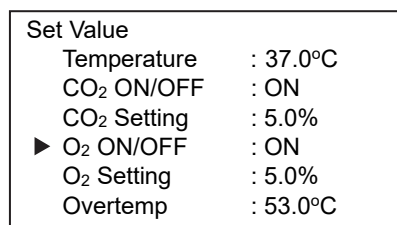

<Left side of the display> [Fig. 2]

3. On the Set Value screen, move the cursor to O₂ ON/OFF [Fig. 2] using the up/down keys (△▽), and press the enter key (ENTER).

▶ The left side of the display changes to the O₂ ON/OFF screen, and the current set value (ON) is displayed [Fig. 3].

4. Use the up/down keys (△▽) to change the control setting value.

◇ Each time the up/down key is pressed the value changes between ON and OFF.

5. Press the enter key (ENTER).

▶ If it is set to ON: the value is confirmed and the display changes to the O₂ Setting screen.

If it is set to OFF: the value is confirmed and the display changes to the Set Value screen.

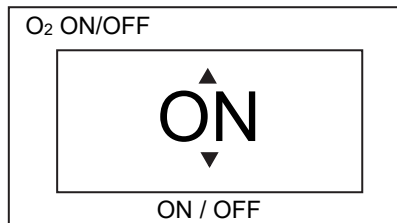

<Right side of the display> [Fig. 3]

6. Press the menu key (MENU/HOME) to display the home screen.

◇ The display returns to the home screen automatically when 90 seconds has passed without any key operation.

BASIC PARAMETERS

Setting O₂ density

The O₂ density during the normal operation of the incubator can be set as follows. The incubator automatically starts operation using these settings after power-on.

- Settable range: 1.0 % – 18.0 %, 22.0 % – 80.0 %
- Factory setting: OFF

Note: When operating the incubator for the first time or after not using it for an extended period of time, set the chamber temperature to the desired temperature and set CO₂ ON/OFF and O₂ ON/OFF to “OFF”, then operate it for at least about 4 hours until the chamber temperature and the CO₂/O₂ sensors become stable. After that, change the setting to the desired O₂ density.

1. On the home screen, press the menu key (MENU/HOME).
▶ The left side of the display changes to the Menu screen.
2. When the cursor on the menu screen is on Set Value [Fig. 1], press the enter key (ENTER).
▶ The display changes to the Set Value screen.
3. On the Set Value screen, move the cursor, to O₂ Setting [Fig. 2] using the up/down keys (△▽), and press the enter key (ENTER).
▶ The right side of the display changes to the O₂ Setting screen, and the current setting value (05.0) is displayed [Fig. 3].
4. Move the cursor using the left/right keys (◀▶) and select the digit you want to change, and then use the up/down keys (△▽) to change the number.
5. Press the enter key (ENTER).
▶ The value is confirmed and the display returns to the Set Value screen.

*If the entered setting value is out of the settable range, the following message is displayed on the right side of the display. Press any key on the control panel to change to the O₂ Setting screen [Fig. 3].

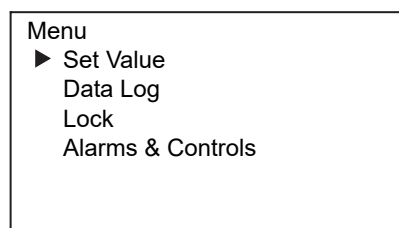

<Left side of the display> [Fig. 1]

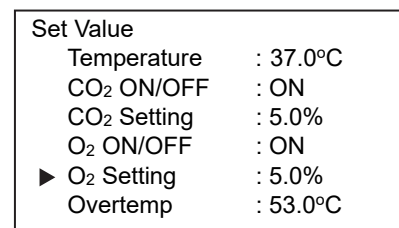

<Left side of the display> [Fig. 2]

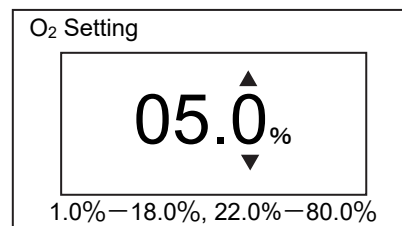

<Right side of the display> [Fig. 3]

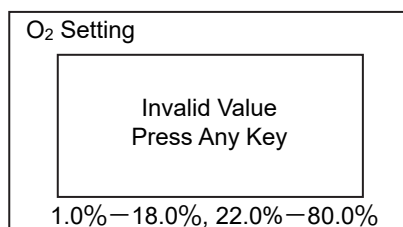

<Right side of the display>

6. Press the menu key (MENU/HOME) to display the home screen.
◇The display returns to the home screen automatically when 90 seconds has passed without any key operation.

BASIC PARAMETERS

Setting high limit temperature alarm

The high limit temperature alarm is different from the temperature alarm (page 61), and it is independent temperature alarm. When the chamber temperature exceeds the temperature set for the high limit temperature alarm, this alarm activates.

The high limit temperature for the normal incubator operation can be set as follows. The incubator automatically starts operation using these settings after power-on.

- Settable range: 20.0 °C – 53.0 °C
- Factory setting: 53.0 °C

Notes:

- Set the temperature of the high limit temperature alarm after the chamber temperature becomes stable at the set value.
- Set the high limit temperature alarm to at least 1 °C higher than the temperature set for the chamber.

1. On the home screen, press the menu key (MENU/HOME).

- ▶ The left side of the display changes to the Menu screen.

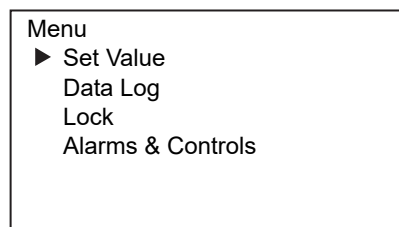

<Left side of the display> [Fig. 1]

2. When the cursor on the Menu screen is on Set Value [Fig. 1], press the enter key (ENTER).

- ▶ The display changes to the Set Value screen.

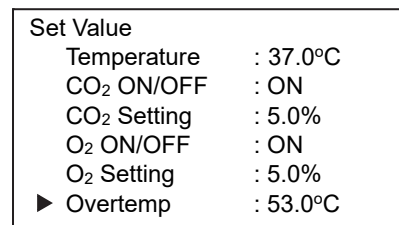

<Left side of the display> [Fig. 2]

3. On the Set Value screen, move the cursor to Overtemp [Fig. 2] using the up/down keys (Δ / ∇), and press the enter key (ENTER).

- ▶ The right side of the screen changes to the Overtemp screen, and the current setting value (53.0) is displayed [Fig.3].

4. Move the cursor using the left/right keys (\triangleleft / \triangleright) and select the digit you want to change, and then use the up/down keys (Δ / ∇) to change the number.

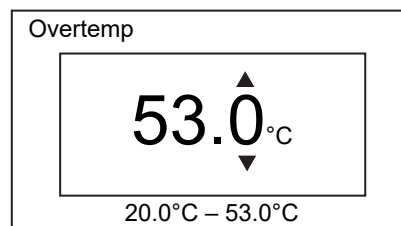

<Right side of the display> [Fig. 3]

5. Press the enter key (ENTER).

- ▶ The value is confirmed and the display returns to the Set Value screen.

*If the entered setting value is out of the settable range, the following message is displayed on the right side of the display: Press any key on the control panel to change to the Overtemp screen [Fig. 3].

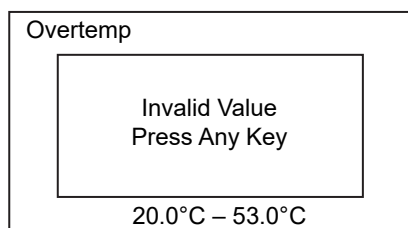

<Right side of the display>

6. Press the menu key (MENU/HOME) to display the home screen.

- ◇ The display returns to the home screen automatically when 90 seconds has passed without any key operation.

BASIC PARAMETERS

Automatic N₂ (O₂) gas cylinder switching

By using this function, the empty N₂ gas (O₂ gas) cylinder can be automatically switched to the other one, when the N₂ gas (O₂ gas) cylinder being used becomes empty.

1. When N₂/O₂ gas is remaining in N₂/O₂ gas cylinder A, the unit operates using N₂/O₂ gas supplied from N₂/O₂ gas cylinder A (Situation 1 in table 2).
2. When N₂/O₂ gas cylinder A is empty, the level of O₂ density in the unit is on the increase/decrease because N₂/O₂ gas is not supplied into the unit even though the N₂/O₂ gas valve in the unit is open (Situation 2 in table 2).
3. When the Situation 2 continues for 2 to 3 minutes, N₂/O₂ gas supply line is automatically switched assuming the N₂/O₂ gas cylinder to be empty. At this time, N₂/O₂ gas cylinder empty alarm is activated, the buzzer sounds, and N₂/O₂ gas supply indicator A is displayed in reverse video and blinks (Situation 3 in table 2).
4. Press the BUZZER STOP key to stop the N₂/O₂ gas cylinder empty alarm. The gas supply indicator A stops blinking (Situation 4 in table 2).
5. Replace the empty N₂/O₂ gas cylinder A with a new one immediately after the Situation 4 (Situation 5 in table 2).
6. When the N₂/O₂ gas cylinder B becomes empty, the supply line is again switched to the N₂/O₂ gas cylinder A.

Table 2. N₂/O₂ gas supply line automatic switching

Situation	N ₂ /O ₂ gas			N ₂ /O ₂ gas supply line indicator		Message display area
	Supply line	Cylinder A	Cylinder B	A	B	
1 N ₂ /O ₂ gas is being supplied from cylinder A.	A	Remaining	Remaining	A Reverse video and light on	B Light on	----
2 O ₂ density in the chamber is on the increase/decrease even if the N ₂ /O ₂ gas valve is open.	A	Empty	Remaining	A Reverse video and light on	B Light on	----
3 N ₂ /O ₂ gas supply line is automatically switched to cylinder B.	B	Empty	Remaining	A Blink	B Reverse video and light on	Err02: N ₂ /O ₂ Gas Empty (and buzzer sound)
4 The BUZZER STOP key is pressed.	B	Empty	Remaining	A Light on	B Reverse video and light on	----
5 Empty gas cylinder A is replaced with a new one.	B	Remaining	Remaining	A Light on	B Reverse video and light on	----

Notes:

- When the BUZZER STOP key is not pressed in the Situation 4 and the N₂/O₂ gas cylinder B gets empty without the N₂/O₂ gas cylinder A being replaced in the Situation 5, the switch operation between N₂/O₂ gas supply lines A and B will be repeated. In this case, replace the both N₂/O₂ gas cylinders A and B with new ones immediately, and press the BUZZER STOP key.
- The switching of N₂ gas (O₂ gas) cylinders is determined by an increase (decrease) of O₂ density in the chamber. The switching of N₂/O₂ gas cylinders may also occur in the situations where the gas tube is clogged, the gas is leaking, the gas pressure has dropped down, or the valve on the gas cylinder is insufficiently open etc., even though the N₂/O₂ gas cylinder being used is not empty.
- Refer to page 21 for how to connect the gas cylinder.

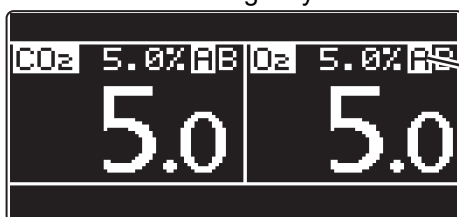

N₂/O₂ gas supply line indicator A and B (N₂/O₂ gas supply line which is used now)

<Right side of the display>

BASIC PARAMETERS

Manual N₂ (O₂) gas supply line A/B switching

The N₂/O₂ gas supply lines A and B can be switched manually at any time.

- Setting values: A or B
- Factory setting: A

1. On the home screen, press the menu key (MENU/HOME).
 - ▶ The left side of the display changes to the Menu screen.
2. On the Menu screen, move the cursor to Alarms & Controls [Fig. 1] using the up/down keys (△▽), and press the enter key (ENTER).
 - ▶ The display changes to the Alarms & Controls screen.
3. On the Alarms & Controls screen, move the cursor to Gas Supply Setting [Fig. 2] using the up/down key (△▽), and press the enter key (ENTER).
 - ▶ The display changes to the Gas Supply Setting screen.
4. With the cursor on the Gas Supply Setting screen on N₂/O₂ Supply [Fig. 3], press the enter key (ENTER).
 - ▶ The right side of the display changes to the N₂/O₂ Supply Setting screen, and the current setting value (A) is displayed [Fig. 4].
5. Use the up/down keys (△▽) to change the N₂/O₂ gas supply setting values.
 - ◇ Each time the up/down key is pressed the value changes between A and B.
6. Press the enter key (ENTER).
 - ▶ The value is confirmed and the display returns to the Gas Supply Setting screen.
7. Press the menu key (MENU/HOME) to display the home screen.
 - ◇ The display returns to the home screen automatically when 90 seconds has passed without any key operation.

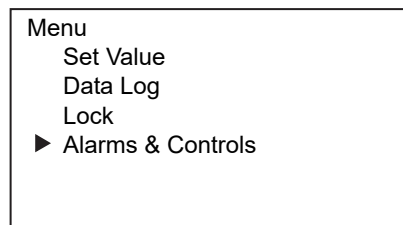

<Left side of the display> [Fig. 1]

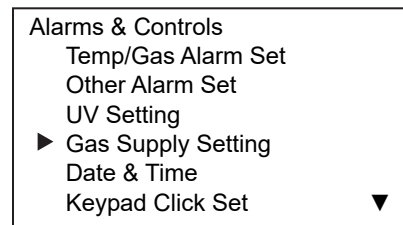

<Left side of the display> [Fig. 2]

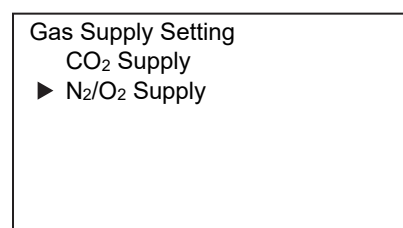



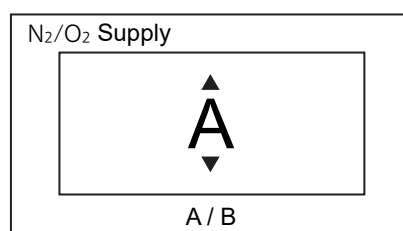

<Left side of the display> [Fig. 3]



<Right side of the display> [Fig. 4]

Note: Table 3 shows the behavior when the N₂/O₂ gas supply line is switched using the N₂(O₂) gas automatic switching function and then manually switched back to the empty N₂/O₂ gas supply line before pressing the BUZZER STOP key.

Table 3. Manual switching from cylinder B to empty cylinder A

	Situation	N ₂ /O ₂ gas			N ₂ /O ₂ gas supply line indicator		Message display area
		Supply line	Cylinder A	Cylinder B	A	B	
1	Automatically switched to the supply line B.	B	Empty	Remaining	 Blink	 Reverse video and Light on	Err02: N ₂ /O ₂ Gas Empty (and buzzer sound)
2	The BUZZER STOP key is not pressed and N ₂ /O ₂ gas supply line was manually switched.	A	Empty	Remaining	 Reverse video and blink	 Light on	

OPERATION/ALARM LOG

Displaying operation log

The product's operation history can be graphically displayed on the display. Furthermore, it is possible to export these records to USB flash drive.

- Graph display setting: Internal temperature, CO₂ density, O₂ density, and the door opening/closing records.
- Initial display: Internal temperature display

1. On the home screen, press the menu key (MENU/HOME).

▶ The left side of the display changes to the Menu screen.

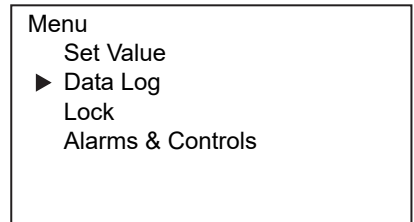

<Left side of the display> [Fig. 1]

2. On the Menu screen, move the cursor to Data Log [Fig. 1] using the up/down keys (△▽), and press the enter key (ENTER).

▶ The display changes to the Data Log screen.

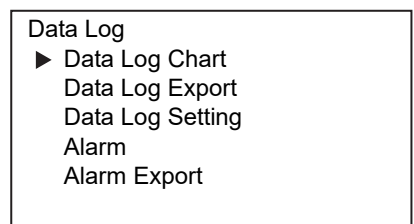

<Left side of the display> [Fig. 2]

3. On the Data Log screen, move the cursor to Data Log Chart [Fig. 2] and press the enter key (ENTER).

▶ The right side of the display changes to the graph screen, and the current setting value (graph showing the temperature in the chamber) is displayed [Fig. 3].

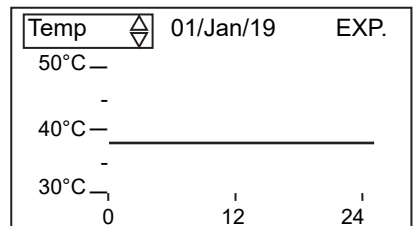

<Right side of the display> [Fig. 3]

4. With Temp on the upper left of the screen highlighted, press the enter key (ENTER).

▶ The display changes to the Data Select screen and the current setting value (TEMP) is displayed [Fig. 4].

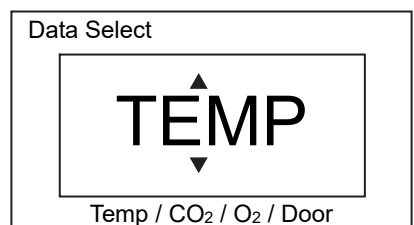

<Right side of the display> [Fig. 4]

5. Use the up/down keys (△▽) to select the data item to be displayed in a graph.

◇ Each time the up/down key is pressed, the display changes between Temp, CO₂, O₂, and Door screens.

- Temp: the record of temperatures in the chamber
- CO₂: the record CO₂ densities in the chamber
- O₂: the record of O₂ densities in the chamber
- Door: the door opening/closing record

6. Press the enter key (ENTER).

▶ A graph of the data is displayed [Fig. 5].

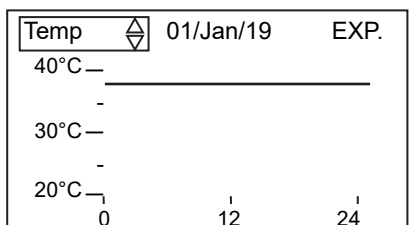

<Right side of the display> [Fig. 5]

*Door opening/closing record graph display [Fig. 6]

- OP: Door opened
- CL: Door closed

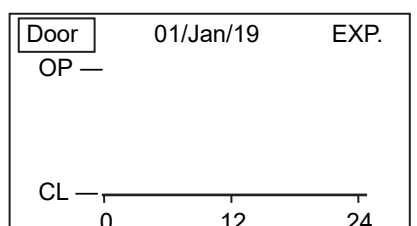

<Right side of the display> [Fig. 6]

OPERATION/ALARM LOG

*When you press the up/down keys ($\Delta \nabla$) while in the graph screen with the graph item on the upper left of the screen highlighted [Fig. 5], the range of the vertical axis of the graphs changes as shown in the table.

Graph item	Display range
Temp	60°C – 50°C – 40°C
	50°C – 40°C – 30°C
	40°C – 30°C – 20°C
	30°C – 20°C – 10°C
	20°C – 10°C – 0°C
CO ₂	25% – 20% – 15%
	20% – 15% – 10%
	15% – 10% – 5%
	10% – 5% – 0%
O ₂	85% – 80% – 75%
	80% – 75% – 70%
	75% – 70% – 65%
	70% – 65% – 60%
	65% – 60% – 55%
	60% – 55% – 50%
	55% – 50% – 45%
	50% – 45% – 40%
	45% – 40% – 35%
	40% – 35% – 30%
	35% – 30% – 25%
	30% – 25% – 20%
	25% – 20% – 15%
	20% – 15% – 10%
15% – 10% – 5%	
Door	OP, CL

7. With the data item (Temp, CO₂, O₂, or Door) on the upper left of the display highlighted [Fig. 5], press the right key (\triangleright).

► The date is highlighted. [Fig. 7]

8. Use the up/down keys ($\Delta \nabla$) to select the date of the data to be displayed in a graph.

◇ Each time the up/down key is pressed the date goes back or forth 1 day, and the data from the selected date is displayed in a graph.

*If you press the enter key (ENTER) instead of the up/down keys ($\Delta \nabla$), the display changes to the Date Select screen [Fig. 8], so after using the left/right keys ($\triangleleft \triangleright$) to move the cursor to the digit you want to change, change the numerical value using the up/down keys ($\Delta \nabla$).

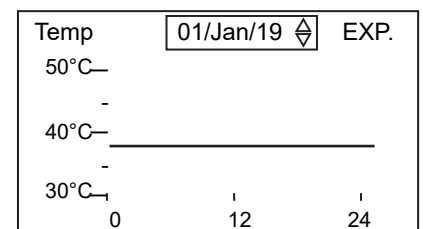

<Right side of the display> [Fig. 7]

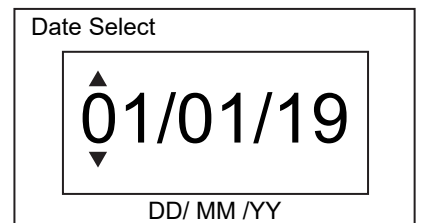

<Right side of the display> [Fig. 8]

OPERATION/ALARM LOG

9. Press the enter key (ENTER).

▶ The log data on the selected date is displayed in a graph.

*If the entered setting value is out of the settable range, the following message is displayed on the right side of the display. Press any key on the control panel to display the Date Select screen [Fig. 8].

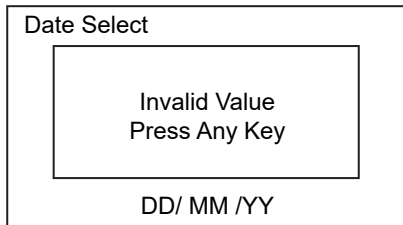

<Right side of the display>

Note: The CO₂ sensor is not stable during the preparation for the gas control. Therefore, the CO₂ density log data may be different from the actual value.

<When exporting data to USB flash drive>

The operation history record of the selected date is exported as a CSV file.

10. With the date display highlighted in the graph [Fig. 9], press the right key (▶).

▶ The EXP. in the upper right of the display is highlighted [Fig. 10].

11. Insert the USB flash drive into the USB port.

Note: USB flash drives that require passwords and USB hubs cannot be used. USB flash drives with capacity of 32 GB or less that employ the FAT16/FAT32 file system are supported.

12. Press the enter key (ENTER). The data will be exported.

▶ While the data is being exported, "Exporting" is displayed on the right side of the display [Fig. 11].

13. When export is complete, "Export complete" is displayed [Fig. 12]. Press any key to return to the graph display screen.

Note: Even after the export of operation log data is complete, operation log data saved in the incubator are not deleted.

*The following messages may come up on the right side of the display:
 "USB flash drive is disconnected": USB flash drive is not inserted
 "USB flash drive is full": there is no available space in the USB flash drive
 "An error occurred": failed to export to USB flash drive
 "No Data": there is no data to export

▶ Press any key on the control panel to return to the graph display screen.

14. Remove the USB flash drive from the USB port.

15. Press the menu key (MENU/HOME) to display the home screen.

◊The display returns to the home screen automatically when 90 seconds has passed without any key operation.

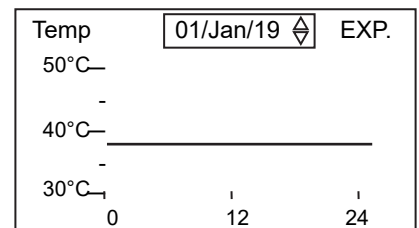

<Right side of the display> [Fig. 9]

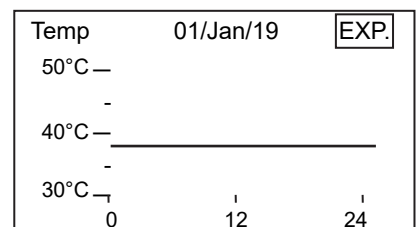

<Right side of the display> [Fig. 10]



<Right side of the display> [Fig. 11]



<Right side of the display> [Fig. 12]

OPERATION/ALARM LOG

Exporting operation log

The temperature in the chamber, CO₂ density, O₂ density, or door opening/closing records can be exported to a USB flash drive.

- Setting values: All or Specified date (1 day only)

1. Insert the USB flash drive into the USB port.

Note: USB flash drives that require passwords and USB hubs cannot be used. USB flash drives with capacity of 32 GB or less that employ the FAT16/FAT32 file system are supported.

2. On the home screen, press the menu key (MENU/HOME).

- ▶ The left side of the display changes to the Menu screen.

3. On the Menu screen, move the cursor to Data Log [Fig. 1] using the up/down keys (Δ / ∇), and press the enter key (ENTER).

- ▶ The display changes to the Data Log screen.

4. On the Data Log screen, move the cursor to Data Log Export [Fig. 2] using the up/down keys (Δ / ∇), and press the enter key (ENTER).

- ▶ The display changes to the Data Log Export screen [Fig. 3].

5. To export a record of a specific date, move the cursor to 24 Hours and press the enter key (ENTER).

- ▶ The right side of the display changes to the Date Select screen [Fig. 4].

6. Move the cursor using the left/right keys (\triangleleft / \triangleright) and select the digit you want to change, and then use the up/down keys (Δ / ∇) to change the number.

7. Press the enter key (ENTER). The record took on the set date is exported to the USB flash drive.

- ▶ While the data is being exported, "Exporting" is displayed on the right side of the display [Fig. 5].

*If the entered setting value is out of the settable range, the following message is displayed on the right side of the display. Press any key on the control panel to change to the Date Select screen [Fig. 4].

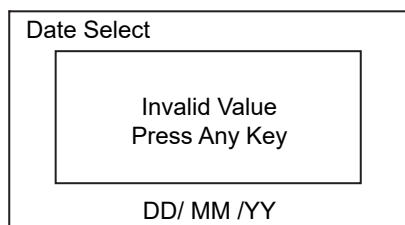

<Right side of the display>

*To export all saved records, select ALL in step 5 and press the enter key (ENTER).

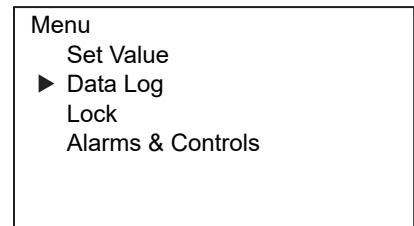

<Left side of the display> [Fig. 1]

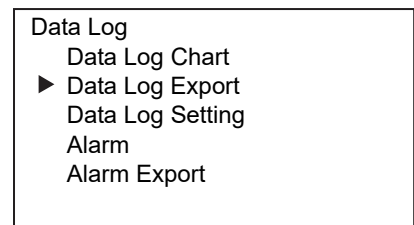

<Left side of the display> [Fig. 2]



<Left side of the display> [Fig. 3]

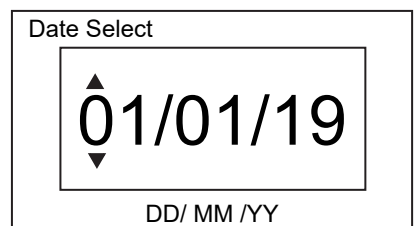

<Right side of the display> [Fig. 4]



<Right side of the display> [Fig. 5]

OPERATION/ALARM LOG

8. When the export is complete, "Export complete" is displayed [Fig. 6]. Press any key to return to the Data Log Export screen.



<Right side of the display> [Fig. 6]

Note: The operation log data saved in the incubator is not deleted even after the completion of the export.

- *The following messages may appear on the right side of the display:
 - "USB memory is disconnected": USB flash drive is not inserted
 - "USB memory is full": there is no available space in the USB flash drive
 - "An error occurred": failed to export to USB flash drive
 - "No Data": there is no data to export

▶ Press any key on the control panel to return to the Data Log Export screen.

9. Remove the USB flash drive from the USB port.

Reference:

- "log" folder is created in the USB flash drive and the export file is saved in the folder in CSV format. The export file name consists of the device ID, date of export, and data name. The date format can be changed in the settings (see page 78).

(Example) When the device is set to "A00001" and data during Jan. 1, 2019 to Apr. 1, 2019 is exported with "All" selected:

	YY/MM/DD	DD/MM/YY
The oldest operation log date - current date	A00001_20190101-20190401_DataLog.csv A00001_20190101-20190401_DoorLog.csv	A00001_01Jan2019-01Apr2019_DataLog.csv A00001_01Jan2019-01Apr2019_DoorLog.csv

(Example) When the device is set to "A00001" and the data on Jan. 1, 2019 is exported with "24 Hours" selected:

	YY/MM/DD	DD/MM/YY
Specified date	A00001_20190101_DataLog.csv A00001_20190101_DoorLog.csv	A00001_01Jan2019_DataLog.csv A00001_01Jan2019_DoorLog.csv

- *The outer door opening/closing history data file is exported together.
- *If the device ID is not set, the default setting "000000" is used.
- *If duplicated file names are used, the data exported later will be overwritten.

10. Press the menu key (MENU/HOME) to display the home screen.

- ◇ The display returns to the home screen automatically when 90 seconds has passed without any key operation.

OPERATION/ALARM LOG

Setting log interval

This product has a function for storing operation history data (records of temperatures in the chamber, CO₂ densities, O₂ densities, and door openings/closings). The log recording interval is set in the following way:

- Setting range: every 2 – 15 minutes
- Factory setting: every 6 minutes (saves about 112 days of data)

1. On the home screen, press the menu key (MENU/HOME).
▶ The left side of the display changes to the Menu screen.
2. On the Menu screen, move the cursor to Data Log [Fig. 1] using the up/down keys (△▽), and press the enter key (ENTER).
▶ The display changes to the Data Log screen.
3. On the Data Log screen, move the cursor to Data Log Setting [Fig. 2] using the up/down keys (△▽), and press the enter key (ENTER).
▶ The display changes to the Data Log Setting screen [Fig. 3].
4. With the cursor on Data Log Interval [Fig. 3], press the enter key (ENTER).
▶ The right side of the display changes to the Data Log Interval screen [Fig. 4].
5. Move the cursor using the left/right keys (◀▶) and select the digit you want to change, and then use the up/down keys (△▽) to change the number.

*If the entered setting value is out of the settable range, the following message is displayed on the right side of the display. Press any key on the control panel to change to the Data Log Interval screen [Fig. 4].

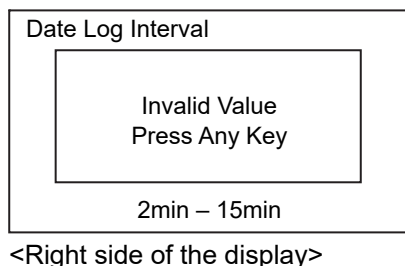

<Right side of the display>

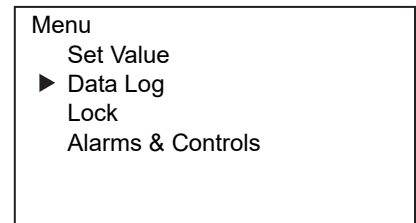

<Left side of the display> [Fig. 1]

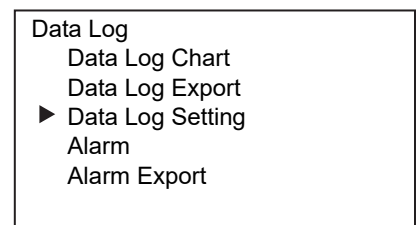

<Left side of the display> [Fig. 2]

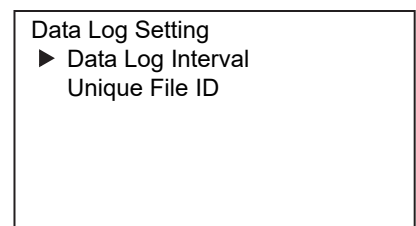

<Left side of the display> [Fig. 3]

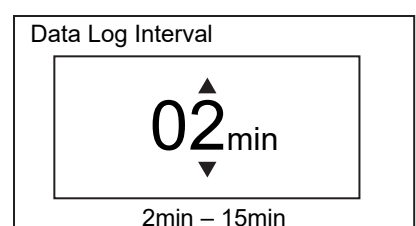

<Right side of the display> [Fig. 4]

6. Press the enter key (ENTER).
▶ The value is confirmed and the display returns to the Data Log Setting screen.
7. Press the menu key (MENU/HOME) to display the home screen.
◇ The display returns to the home screen automatically when 90 seconds has passed without any key operation.

Note: Relation between log interval and the estimated amount of data that can be saved

- Log interval = every 2 minutes: Approx. 48 days
- Log interval = every 6 minutes: Approx. 112 days
- Log interval = every 15 minutes: Approx. 168 days

When saving the amount of data more than the above, the oldest data is deleted and new data is written.

OPERATION/ALARM LOG

Setting Unique ID

You can set the unique device ID that will be a part of the file name (CSV file) exported to the USB flash drive.

- Setting values: 6 digits of alphanumeric characters (capital letters only if using letters)
- Factory setting: 000000

1. On the home screen, press the menu key (MENU/HOME).

▶ The left side of the display changes to the Menu screen.

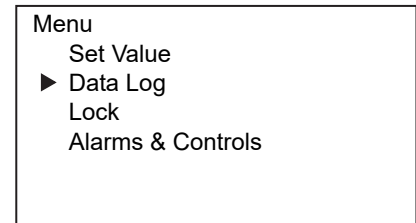

<Left side of the display> [Fig. 1]

2. On the Menu screen, move the cursor to Data Log [Fig. 1] using the up/down keys ($\Delta \nabla$), and press the enter key (ENTER).

▶ The display changes to the Data Log screen.

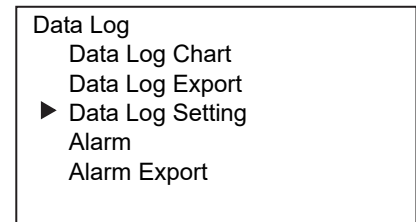

<Left side of the display> [Fig. 2]

3. On the Data Log screen, move the cursor to Data Log Setting [Fig. 2] using the up/down keys ($\Delta \nabla$), and press the enter key (ENTER).

▶ The display changes to the Data Log Setting screen.

4. On the Data Log Setting screen, move the cursor to Unique File ID [Fig. 3] using the up/down keys ($\Delta \nabla$), and press the enter key (ENTER).

▶ The right side of the display changes to the Unique File ID screen [Fig. 4].

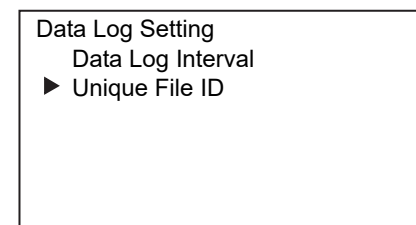

<Left side of the display> [Fig. 3]

5. Move the cursor using the left/right keys ($\triangleleft \triangleright$) and select the digit you want to change, and then use the up/down keys ($\Delta \nabla$) to change the number.

6. Press the enter key (ENTER).

▶ The value is confirmed and the display returns to the Data Log Setting screen.

7. Press the menu key (MENU/HOME) to display the home screen.

✧ The display returns to the home screen automatically when 90 seconds has passed without any key operation.

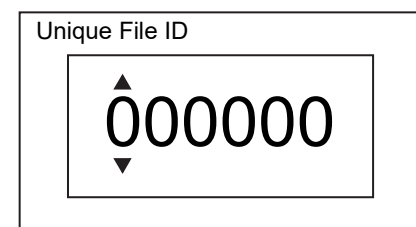

<Right side of the display> [Fig. 4]

OPERATION/ALARM LOG

Displaying alarm log

This product has a function for storing alarm history (maximum 256 cases). The alarm history stored in this product can be displayed on the display.

Note: When the alarm history records reach to more than 256, the oldest record is deleted.

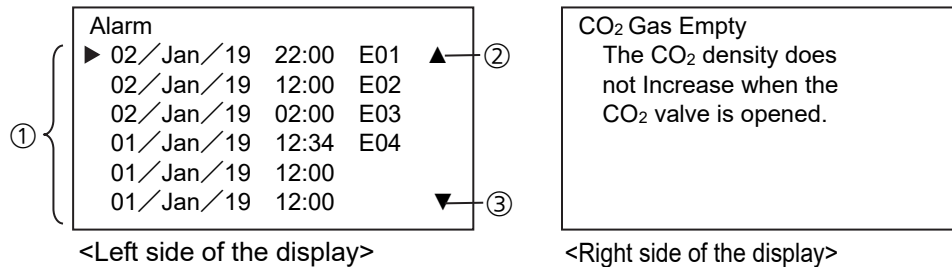

Alarm screen (left side of the display)

① Up to 6 alarm records can be displayed on the screen at a time. The display shows the date and time of alarm and error code.

✧ For details on error codes, see page 86–88.

② Scroll up symbol

This symbol appears when scroll up is possible.

✧ When ▲ is displayed, you can see the newer records by pressing the up key (△).

③ Scroll down symbol

This symbol appears when scroll down is possible.

✧ When ▼ is displayed, you can see the older records by pressing the down key (▽).

Error message screen (right side of the display)

The error/alarm message for the record pointed by the cursor on the alarm screen is displayed.

✧ For details on error messages, see pages 86–89.

1. On the home screen, press the menu key (MENU/HOME).

▶ The left side of the display changes to the Menu screen.

2. On the Menu screen, move the cursor to Data Log [Fig. 1] using the up/down keys (△▽), and press the enter key (ENTER).

▶ The display changes to the Data Log screen.

3. On the Data Log screen, move the cursor to Alarm [Fig. 2] using the up/down keys (△▽), and press the enter key (ENTER).

▶ The display changes to the Alarm screen. [Fig. 3]

Left side of the display: Alarm screen

Right side of the display: error message screen

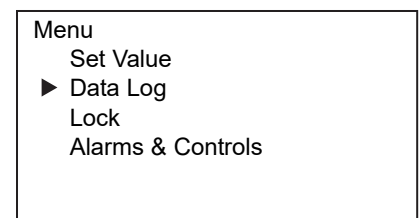

<Left side of the display> [Fig. 1]

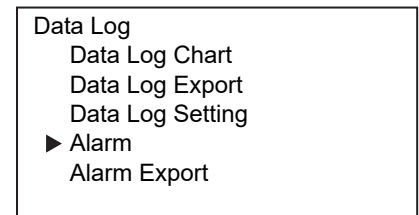

<Left side of the display> [Fig. 2]

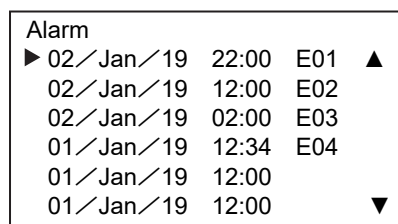

<Left side of the display>

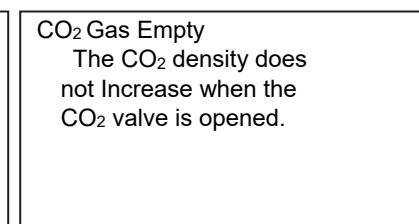

<Right side of the display> [Fig. 3]

4. Press the menu key (MENU/HOME) to display the home screen.

✧ The display returns to the home screen automatically when 90 seconds has passed without any key operation.

OPERATION/ALARM LOG

Exporting alarm log

The alarm history data stored in this product can be exported to a USB flash drive in CSV format.

- Setting values: All or Specified date (1 day only)

1. Insert the USB flash drive into the USB port.

Note: USB flash drives that require passwords and USB hubs cannot be used. USB flash drives with capacity of 32 GB or less that employ the FAT16/FAT32 file system are supported.

2. On the home screen, press the menu key (MENU/HOME).

- ▶ The left side of the display changes to the Menu screen.

3. On the Menu screen, move the cursor to Data Log [Fig. 1] using the up/down keys (Δ / ∇), and press the enter key (ENTER).

- ▶ The display changes to the Data Log screen.

4. On the Data Log screen, move the cursor to Alarm Export [Fig. 2] using the up/down keys (Δ / ∇), and press the enter key (ENTER).

- ▶ The display changes to the Alarm Export screen [Fig. 3].

5. To export a record of a specific date, move the cursor to 24 Hours and press the enter key (ENTER).

- ▶ The right side of the display changes to the Date Select screen [Fig. 4].

6. Move the cursor using the left/right keys (\triangleleft / \triangleright) and select the digit you want to change, and then use the up/down keys (Δ / ∇) to change the number.

7. Press the enter key (ENTER). The record took on the set date is exported to the USB flash drive.

- ▶ While the data is being exported, "Exporting" is displayed on the right side of the display [Fig. 5].

*If the entered setting value is out of the settable range, the following message is displayed on the right side of the display: Press any key on the control panel to change to the Date Select screen [Fig. 4].

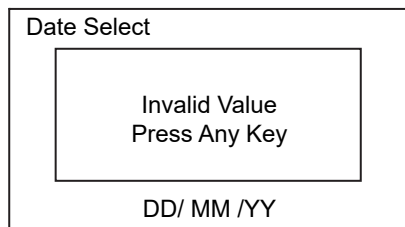

<Right side of the display>

*To export all saved records, select ALL in step 5 and press the enter key (ENTER).

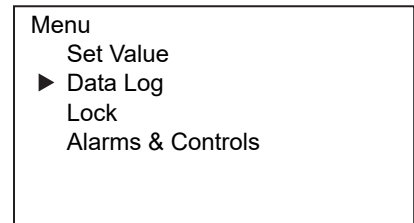

<Left side of the display> [Fig. 1]

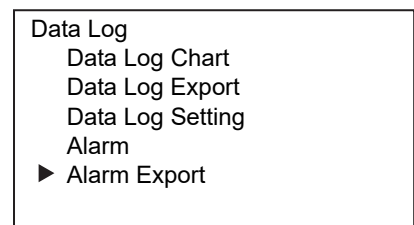

<Left side of the display> [Fig. 2]



<Left side of the display> [Fig. 3]

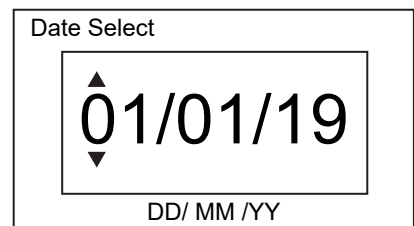

<Right side of the display> [Fig. 4]



<Right side of the display> [Fig. 5]

OPERATION/ALARM LOG

8. When the export is complete, "Export complete" is displayed [Fig. 6]. Press any key to return to the Alarm Export screen.

Note: The alarm log data saved in the incubator is not deleted even after the completion of the export.



<Right side of the display> [Fig. 6]

*The following messages may be displayed:

- "USB memory is disconnected": USB flash drive is not inserted
- "USB memory is full": there is no available space in the USB flash drive
- "An error occurred": failed to export to USB flash drive
- "No Data": there is no data to export

▶ Press any key on the control panel to return to the Alarm Export screen.

9. Remove the USB flash drive from the USB port.

Reference:

• "log" folder is created in the USB flash drive and the export file is saved in the folder in CSV format. The export file name consists of the device ID, date of export, and data name. The date format can be changed in the settings (see page 78).

(Example) When the device is set to "A00001" and data during Jan. 1, 2019 to Apr. 1, 2019 is exported with "All" selected:

	YY/MM/DD	DD/MM/YY
The oldest alarm log date - current date	A00001_20190101-20190401_AlarmLog.csv	A00001_01Jan2019-01Apr2019_AlarmLog.csv

(Example) When the device is set to "A00001" and the data on Jan. 1, 2019 is exported with "24 Hours" selected:

	YY/MM/DD	DD/MM/YY
Specified date	A00001_20190101_AlarmLog.csv	A00001_01Jan2019_AlarmLog.csv

*If the device ID is not set, the default setting "000000" is used.

*If duplicated file names are used, the data exported later will be overwritten.

10. Press the menu key (MENU/HOME) to display the home screen.

◇The display returns to the home screen automatically when 90 seconds has passed without any key operation.

KEY LOCK FUNCTION

Setting key lock

The keys can be locked to prevent the setting from being incorrectly changed. If the key lock is set to ON, the settings cannot be changed even if the keys on the control panel are pressed.

- Setting values: ON or OFF
- Factory setting: OFF

1. On the home screen, press the menu key (MENU/HOME).
 - ▶ The left side of the display changes to the Menu screen.
2. On the Menu screen, move the cursor to Lock [Fig. 1] using the up/down keys ($\Delta \nabla$), and press the enter key (ENTER).
 - ▶ The display changes to the Lock screen [Fig. 2].
3. When the cursor in the Lock screen is on Keypad Lock [Fig. 2], press the enter key (ENTER).
 - ▶ The right side of the display changes to the Keypad Lock ON/OFF setting screen, and the current setting value (OFF) is displayed [Fig. 3].
4. Press the up/down keys ($\Delta \nabla$) to change it to ON.
 - ◇ Each time the up/down key is pressed, the value toggles between ON and OFF.
5. Press the enter key (ENTER).
 - ▶ The Password screen is displayed [Fig. 4].
6. Enter a password (6 digits) by using the left/right keys ($\triangleleft \triangleright$) to move the cursor on the digits to be changed and using the up/down keys ($\Delta \nabla$) to set the numerical values, and then press the enter key (ENTER).
 - ▶ The Confirm Password screen is displayed [Fig. 5].
7. Enter the password (6 digits) again by using the left/right keys ($\triangleleft \triangleright$) to move the cursor on the digits to be changed and using the up/down keys ($\Delta \nabla$) to set the numerical values, and then press the enter key (ENTER).
 - ▶ The display returns to the Lock screen and LOCK is displayed on the upper right of the screen [Fig. 6].

*If the password does not match the initially entered password, the following message is displayed on the right side of the display. Pressing any of the up/down/left/right keys ($\Delta \nabla \triangleleft \triangleright$) returns to the Lock screen, so return to Step 3 and set the password again.

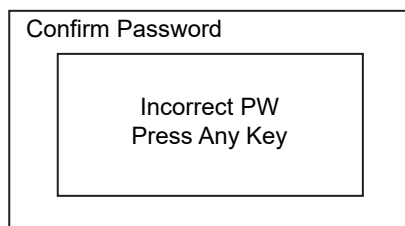

<Right side of the display>

Note: To prevent unauthorized use of the password, the password should be properly managed by qualified administrators only.

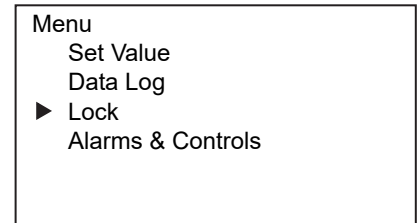

<Left side of the display> [Fig. 1]

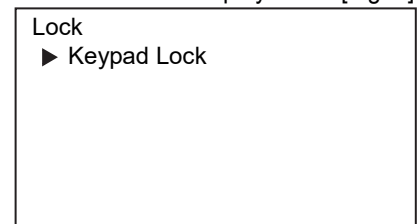

<Left side of the display> [Fig. 2]

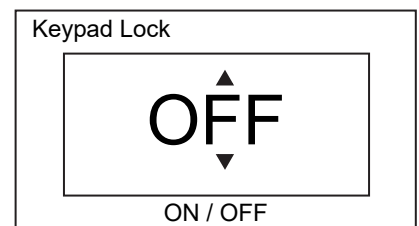

<Right side of the display> [Fig. 3]

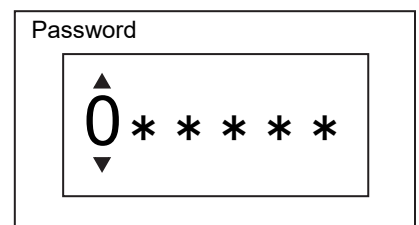

<Right side of the display> [Fig. 4]

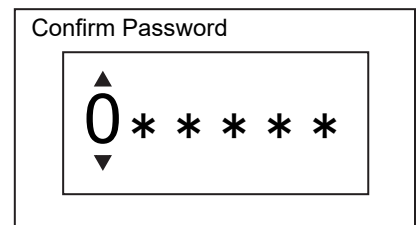

<Right side of the display> [Fig. 5]

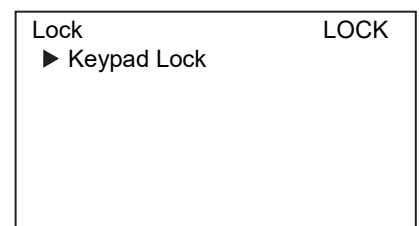

<Left side of the display> [Fig. 6]

KEY LOCK FUNCTION

8. Press the menu key (MENU/HOME) to return to the home screen.

✦The display returns to the home screen automatically when 90 seconds has passed without any key operation.

Cancelling key lock

When the key lock is set to OFF, it is possible to change the settings.

1. On the home screen, press the menu key (MENU/HOME).
 - ▶ The left side of the display changes to the Menu screen.
 2. On the Menu screen, move the cursor to Lock [Fig. 1] using the up/down keys ($\Delta \nabla$), and press the enter key (ENTER).
 - ▶ The display changes to the Lock screen [Fig. 2].
 3. When the cursor in the Lock screen is on Keypad Lock [Fig. 2], press the enter key (ENTER).
 - ▶ The right side of the display changes to the Keypad Lock ON/OFF setting screen and the current setting value (ON) is displayed [Fig. 3].
 4. Press the up/down keys ($\Delta \nabla$) to change it to OFF.
 - ✦Each time the up/down key is pressed, the value toggles between ON and OFF.
 5. Press the enter key (ENTER).
 - ▶ The Confirm Password screen is displayed [Fig. 4].
 6. Enter the password (6 digits) by using the left/right keys ($\triangleleft \triangleright$) to move the cursor on the digits to be changed and using the up/down keys ($\Delta \nabla$) to set the numerical values, and then press the enter key (ENTER).
 - ▶ The display returns to the Lock screen and LOCK on the upper right of the screen disappears [Fig. 5].
- Reference:** The key lock release password is deleted.

*If the password does not match the password entered when setting the key lock to ON, the following message is displayed on the right side of the display. Pressing any of the up/down/left/right keys ($\Delta \nabla \triangleleft \triangleright$) returns to the Lock screen, so return to Step 3 and follow the procedure again.

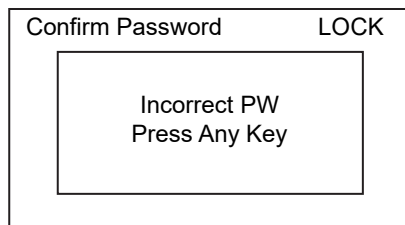

<Right side of the display>

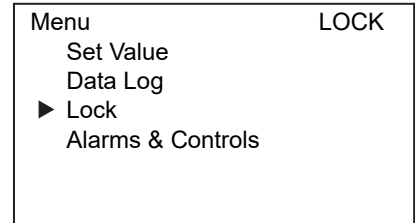

<Left side of the display> [Fig. 1]

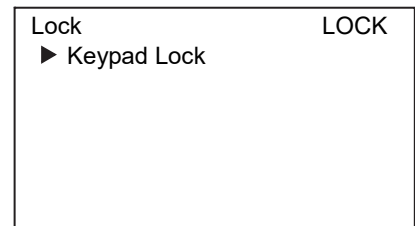

<Left side of the display> [Fig. 2]

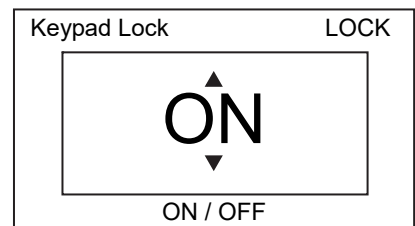

<Right side of the display> [Fig. 3]

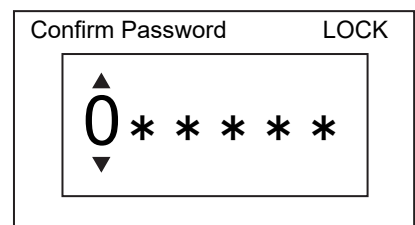

<Right side of the display> [Fig. 4]

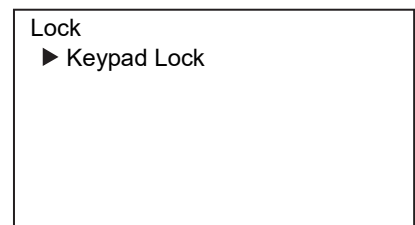

<Left side of the display> [Fig. 5]

7. Press the menu key (MENU/HOME) to display the home screen.

✦The display returns to the home screen automatically when 90 seconds has passed without any key operation.

ELECTRIC LOCK (OPTION)

The outer door can be automatically locked by the electric lock when specified amount of time has elapsed after closing the outer door. To use this door lock function, the electric lock MCO-170EL (optional accessory) should be installed on the unit.

Setting door lock

The setting of the door lock function is as follows.

- Setting values: ON or OFF
- Factory setting: ON

1. Press the Menu key (MENU/HOME) while the Home screen is displayed.

▶ The left side of the display switches to the Menu screen.

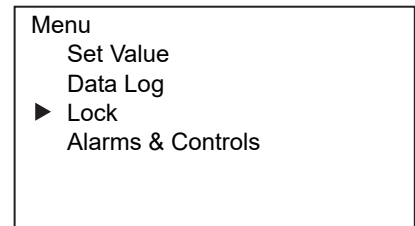

<Left side of the display> [Fig. 1]

2. Move the cursor in the Menu screen to Lock using the up/down keys (Δ / ∇) [Fig. 1], and then press the Enter key (ENTER).

▶ The screen switches to the Lock screen [Fig. 2].

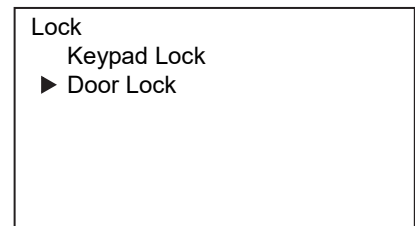

<Left side of the display> [Fig. 2]

3. Move the cursor in the Menu screen to Door Lock using the up/down keys (Δ / ∇) [Fig. 2], and then press the Enter key (ENTER).

▶ The left side of the display switches to the Door Lock screen [Fig. 3].

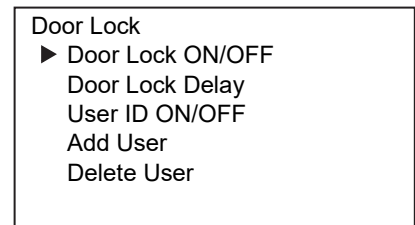

<Left side of the display> [Fig. 3]

4. While the cursor is on Door Lock ON/OFF in the Door Lock screen [Fig. 3], press the Enter key (ENTER).

▶ The right side of the display switches to the Door Lock ON/OFF screen and the current setting is displayed [Fig. 4].

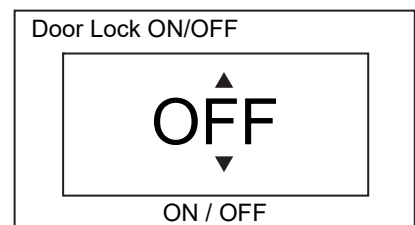

<Right side of the display> [Fig. 4]

5. Press the up/down keys (Δ / ∇) to change the setting to ON/OFF.

◇ The setting toggles between ON and OFF each time the up/down key is pressed.

6. Press the Enter key (ENTER).

▶ When set to ON: The Door Lock Delay screen is displayed.
When set to OFF: The Door Lock screen is displayed.

7. Press the menu key (MENU/HOME) to display the home screen.

◇ The display returns to the home screen automatically when 90 seconds has passed without any key operation.

ELECTRIC LOCK (OPTION)

Setting door lock delay time

You can specify the amount of time until the outer door is automatically locked after closing the door (door lock delay time).

- Settable range: 0 – 60 minutes (when the setting is 0 minutes, the Door Lock ON/OFF becomes “OFF.”)
- Factory setting: 1 minute

1. Press the Menu key (MENU/HOME) while the Home screen is displayed.

- ▶ The left side of the display switches to the Menu screen.

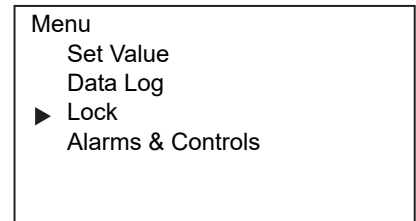

<Left side of the display> [Fig. 1]

2. Move the cursor in the Menu screen to Lock using the up/down keys (Δ / ∇) [Fig. 1], and then press the Enter key (ENTER).

- ▶ The screen switches to the Lock screen [Fig. 2].

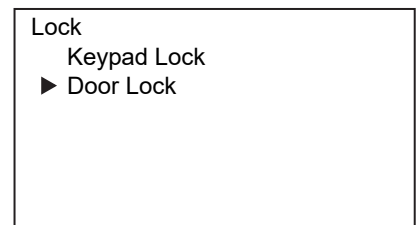

<Left side of the display> [Fig. 2]

3. Move the cursor in the Lock screen to Door Lock using the up/down keys (Δ / ∇) [Figure 2], and then press the Enter key (ENTER).

- ▶ The left side of the display switches to the Door Lock screen [Fig. 3].

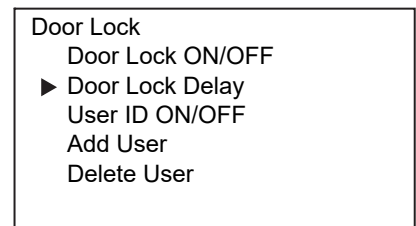

<Left side of the display> [Fig. 3]

4. Move the cursor in the Door Lock screen to Door Lock Delay using the up/down keys (Δ / ∇) [Fig. 3], and then press the Enter key (ENTER).

- ▶ The right side of the display switches to the Door Lock Delay screen and the current setting (01) is displayed [Fig. 4].

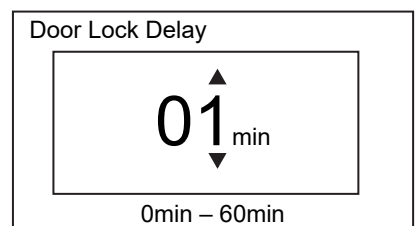

<Right side of the display> [Fig. 4]

5. Move the cursor with the left/right keys (\triangleleft / \triangleright) and select the digit to change, and then change the numerical value using the up/down keys (Δ / ∇).

6. Press the Enter key (ENTER).

- ▶ The Door Lock screen is displayed.

*If the specified value is out of the settable range, the following message is displayed on the right side of the display. Press any key on the Control Panel to display the Door Lock Delay screen [Fig. 4].

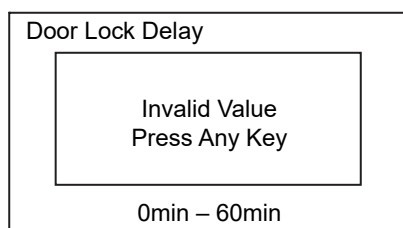

<Right side of the display>

7. Press the menu key (MENU/HOME) to display the home screen.

◇ The display returns to the home screen automatically when 90 seconds has passed without any key operation.

ELECTRIC LOCK (OPTION)

Specifying the method to unlock the outer door

The User ID ON/OFF setting specifies the method for unlocking the outer door when it is locked.

Method 1. When the User ID is set to ON: Press the Unlock key (UNLOCK), and then enter the user ID and the password to unlock the outer door.

See the operational procedure for more information (page 57).

Method 2. When the User ID is set to OFF: Press the Unlock key (UNLOCK) to unlock the outer door.

Use the following steps to set the User ID ON or OFF.

- Setting values: ON or OFF
- Factory setting: OFF

1. Press the Menu key (MENU/HOME) while the Home screen is displayed.

▶ The left side of the display switches to the Menu screen.

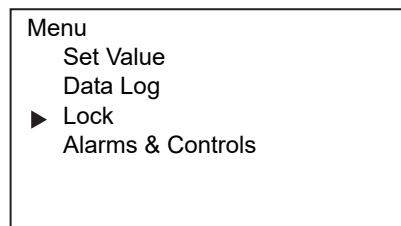

<Left side of the display> [Fig. 1]

2. Move the cursor in the Menu screen to Lock using the up/down keys (Δ / ∇) [Fig. 1], and then press the Enter key (ENTER).

▶ The screen switches to the Lock screen [Fig. 2].

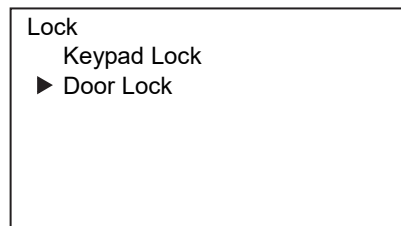

<Left side of the display> [Fig. 2]

3. Move the cursor in the Lock screen to Door Lock using the up/down keys (Δ / ∇) [Fig. 2], and then press the Enter key (ENTER).

▶ The left side of the display switches to the Door Lock screen [Fig. 3].

Note: If the User ID is set to ON, the user ID and password to release the outer door lock is required when "Door Lock" is selected.

4. Move the cursor in the Door Lock screen to User ID ON/OFF using the up/down keys (Δ / ∇) [Fig. 3], and then press the Enter key (ENTER).

▶ The right side of the display switches to the User ID ON/OFF screen and the current setting (OFF) is displayed [Fig. 4].

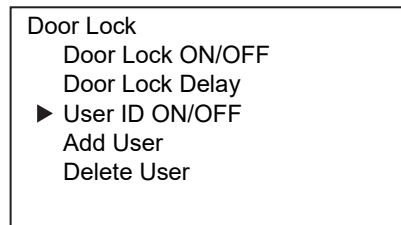

<Left side of the display> [Fig. 3]

5. Press the up/down keys (Δ / ∇) to change the setting to ON.

✧ The setting toggles between ON and OFF each time an up/down key is pressed.

6. Press the Enter key (ENTER).

▶ The Door Lock screen is displayed.

*If there are no user IDs registered, the following message is displayed on the right side of the display. Press any key on the Control Panel to display the User ID ON/OFF screen [Fig. 4].

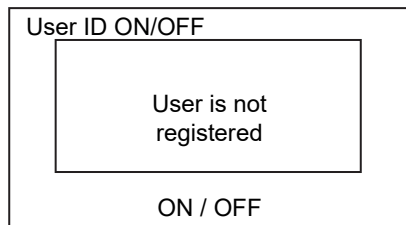

<Right side of the display>

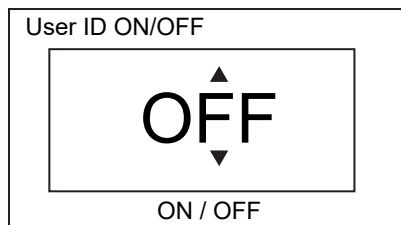

<Right side of the display> [Fig. 4]

7. Press the menu key (MENU/HOME) to display the home screen.

✧ The display returns to the home screen automatically when 90 seconds has passed without any key operation.

ELECTRIC LOCK (OPTION)

Unlocking the outer door with a User ID

Press the Unlock key (UNLOCK), and then enter the user ID to unlock the outer door. This procedure is as follows.

*The User ID must be set to ON to use this method for unlocking the outer door.

1. Press the Unlock key (UNLOCK) while the Home screen is displayed.
▶ The right side of the display switches to the User ID screen [Fig. 1].

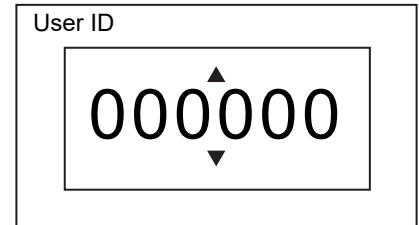

<Right side of the display> [Fig. 1]

2. Move the cursor to select each digit of the User ID (6 digits) with the left/right keys (◀▶), enter the alphanumerical values using the up/down keys (△▽), and then press the Enter key (ENTER) (for setting the user ID, see pages 58 – 59).

▶ The Confirm Password window is displayed [Fig. 2].

3. Move the cursor to select each digit of the password (6 digits) with the left/right keys (◀▶), enter the numerical values using the up/down keys (△▽), and then press the Enter key (ENTER) (for the password settings, see pages 58 – 59).

▶ The door is unlocked and the Home screen is displayed.

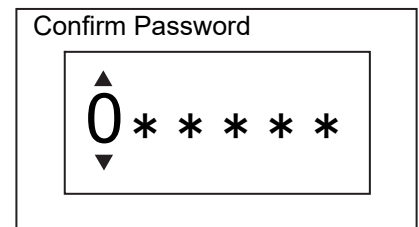

<Right side of the display> [Fig. 2]

*If the password does not match the existing password, the following message is displayed on the right side of the display. Press either of the up/down/left/right key to return to the Home screen, and then repeat the procedure from Step 1 above.

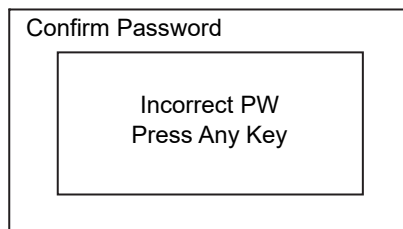

<Right side of the display>

4. Press the menu key (MENU/HOME) to display the home screen.

◇The display returns to the home screen automatically when 90 seconds has passed without any key operation.

Unlocking the outer door during a power outage or malfunction

A key to open the lock in the event of a power outage or lock malfunction is included with the electric lock. Usually, this key should be kept in a safe place and managed carefully. It is recommended to make a note of the symbols and serial number of the key in case the key is lost.

• Unlocking the outer door during a power outage

The outer door is locked by the electric lock if the power is cut. In such a case, use the key included with the electric lock to open the lock. To lock the door again, turn the key to the lock position while the outer door is open, and then close the outer door.

Note: The key cannot lock the outer door when it is closed. Forcefully turning the key in the lock may damage the electric lock. Always lock the outer door while the door is open.

ELECTRIC LOCK (OPTION)

Registering user ID/password

You can register user IDs and passwords for unlocking the outer door. Use the following steps to set the values.

- Setting value
 - User ID: 6-digit alphanumeric characters (only capital letters are available for alphabetic characters).
 - Password: 6-digit number
- Factory setting: Not registered

1. Press the Menu key (MENU/HOME) while the Home screen is displayed.
 - ▶ The left side of the display switches to the Menu screen.
2. Move the cursor in the Menu screen to Lock using the up/down keys (Δ / ∇) [Fig. 1], and then press the Enter key (ENTER).
 - ▶ The screen switches to the Lock screen [Fig. 2].
3. Move the cursor in the Lock screen to Door Lock using the up/down keys (Δ / ∇) [Fig. 2], and then press the Enter key (ENTER).
 - ▶ The left side of the display switches to the Door Lock screen [Fig. 3].
4. Move the cursor in the Door Lock screen to Add User using the up/down keys (Δ / ∇) [Fig. 3], and then press the Enter key (ENTER).
 - ▶ The right side of the display switches to the Add User screen [Fig. 4].
5. Move the cursor to select each digit of the user ID (6 digits) with the left/right keys (\triangleleft / \triangleright), enter the alphanumerical values using the up/down keys (Δ / ∇), and then press the Enter key (ENTER).
 - ▶ The Password screen is displayed [Fig. 5].

*A maximum of 99 user IDs can be set.
 *When you try to register the 100th user ID, the following message is displayed on the right side of the display. Delete an unnecessary user ID referring to page 60, and then register a new user ID.

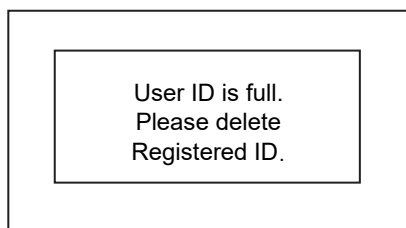

<Right side of the display>

*If the user ID is already registered, the following message is displayed on the right side of the display. Press any key on the Control Panel to display the Add User screen [Fig. 4].

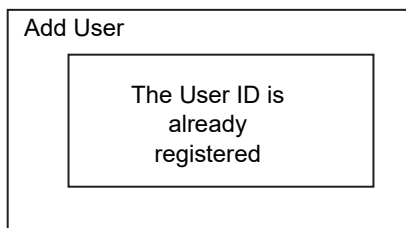

<Right side of the display>

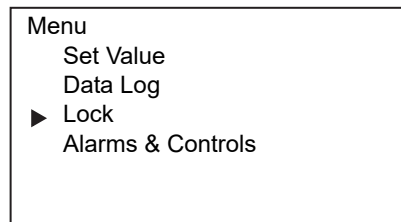

<Left side of the display> [Fig. 1]

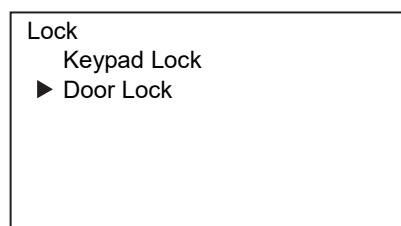

<Left side of the display> [Fig. 2]

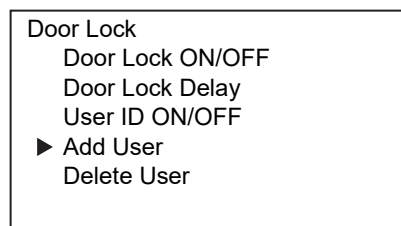

<Left side of the display> [Fig. 3]

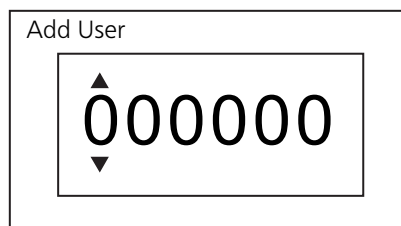

<Right side of the display> [Fig. 4]

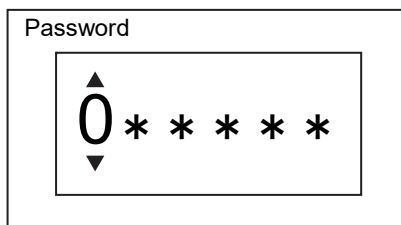

<Right side of the display> [Fig. 5]

ELECTRIC LOCK (OPTION)

6. Move the cursor to select each digit of the password (6 digits) with the left/right keys (◀▶), set the numerical values using the up/down keys (▲▼), and then press the Enter key (ENTER).

▶ The Confirm Password screen is displayed [Fig. 6].

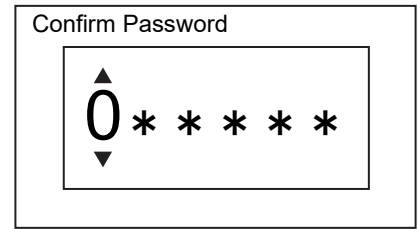

<Right side of the display> [Fig. 6]

7. For confirming the password, move the cursor to select each digit of the password (6 digits) with the left/right keys (◀▶) again, set the same numerical values using the up/down keys (▲▼), and then press the Enter key (ENTER).

▶ The setting is specified and the Door Lock screen is displayed.

*If the password in Confirm Password does not match the password that was first entered, the following message is displayed on the right side of the display. Press either the up/down/left/right key to return to the Door Lock screen, and then repeat the procedure from Step 4 above.

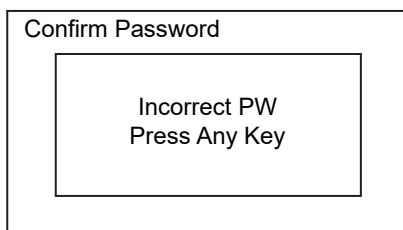

<Right side of the display>

Reference:

- This outer door unlock password is used when opening the outer door when it is locked. This password differs from the key lock password (pages 52 – 53).

8. Press the menu key (MENU/HOME) to display the home screen.

✧The display returns to the home screen automatically when 90 seconds has passed without any key operation.

Note: To prevent unauthorized use of the password, the password should be properly managed by only qualified administrators.

ELECTRIC LOCK (OPTION)

Deleting User IDs

The user ID registered to unlock the outer door can be deleted. Use the following steps to delete the user ID.

1. Press the Menu key (MENU/HOME) while the Home screen is displayed.

▶ The left side of the display switches to the Menu screen.

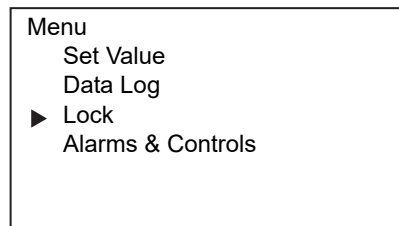

<Left side of the display> [Fig. 1]

2. Move the cursor in the Menu screen to Lock using the up/down keys (△▽) [Fig. 1], and then press the Enter key (ENTER).

▶ The screen switches to the Lock screen [Fig. 2].

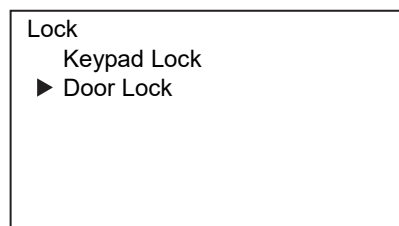

<Left side of the display> [Fig. 2]

3. Move the cursor in the Lock screen to Door Lock using the up/down keys (△▽) [Fig. 2], and then press the Enter key (ENTER).

▶ The left side of the display switches to the Door Lock screen [Fig. 3].

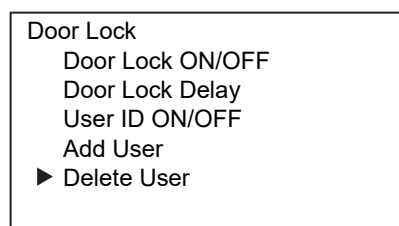

<Left side of the display> [Fig. 3]

4. Move the cursor in the Door Lock screen to Delete User using the up/down keys (△▽) [Fig. 3], and then press the Enter key (ENTER).

▶ The right side of the display switches to the Delete User screen [Fig. 4].

*If there are no user IDs registered, the following message is displayed on the right side of the display.

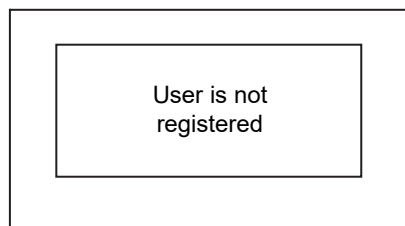

<Right side of the display>

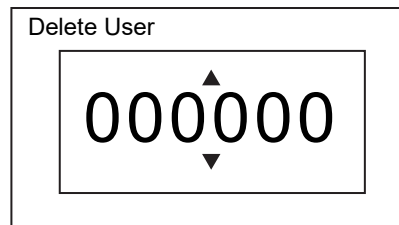

<Right side of the display> [Fig. 4]

5. Enter the User ID (6 digits) using the left/right keys (◀▶) and the up/down keys (△▽), and then press the Enter key (ENTER).

▶ The Confirm Password window is displayed [Fig. 5].

6. Move the cursor to select each digit of the password (6 digits) with the left/right keys (◀▶), enter the numerical values using the up/down keys (△▽), and then press the Enter key (ENTER).

▶ The user ID is deleted and the Door Lock screen is displayed.

Reference: If the number of user IDs that have registered falls to zero, the user ID setting is set to OFF.

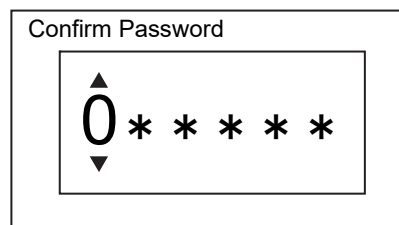

<Right side of the display> [Fig. 5]

*If the password does not match the existing password, the following message is displayed on the right side of the display. Press either the up/down/left/right key to return to the Door Lock screen, and then repeat the procedure from Step 4 above.

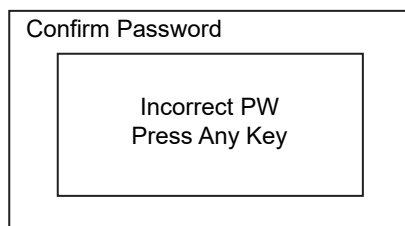

<Right side of the display>

7. Press the menu key (MENU/HOME) to display the home screen.

◇ The display returns to the home screen automatically when 90 seconds has passed without any key operation.

ALARM PARAMETERS

Setting temperature alarm

When the temperature goes out of the preset range (the set chamber temperature \pm the set temperature alarm value), the alarm activates. The temperature alarm value can be set as follows.

- Settable range: $\pm 1.0\text{ }^{\circ}\text{C} - \pm 5.0\text{ }^{\circ}\text{C}$
- Factory setting: $\pm 1.0\text{ }^{\circ}\text{C}$

1. On the home screen, press the menu key (MENU/HOME).

▶ The left side of the display changes to the Menu screen.

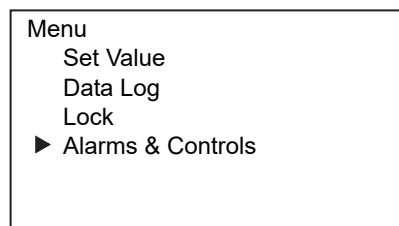

<Left side of the display> [Fig. 1]

2. On the Menu screen, move the cursor to Alarms & Controls [Fig. 1] using the up/down keys (Δ / ∇), and press the enter key (ENTER).

▶ The display changes to the Alarms & Controls screen.

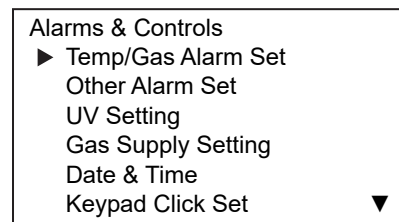

<Left side of the display> [Fig. 2]

3. When the cursor in the Alarms & Controls screen is on Temp/Gas Alarm Set [Fig. 2], press the enter key (ENTER).

▶ The display changes to the Temp/Gas Alarm Set screen.

4. When the cursor in the Temp/Gas Alarm Set screen is on Temp Alarm [Fig. 3], press the enter key (ENTER).

▶ The right side of the display changes to the Temp Alarm screen, and the current setting value (± 1.0) is displayed [Fig. 4].

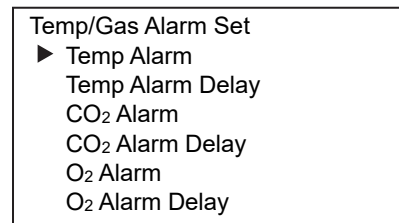

<Left side of the display> [Fig. 3]

5. Move the cursor using the left/right keys (\triangleleft / \triangleright) and select the digit you want to change, and then use the up/down keys (Δ / ∇) to change the number.

6. Press the enter key (ENTER).

▶ The value is confirmed and the display returns to the Temp/Gas Alarm Set screen.

*If the entered setting value is out of the settable range, the following message is displayed on the right side of the display. Press any key on the control panel to change to the Temp Alarm screen [Fig. 4].

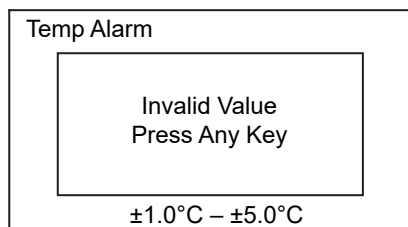

<Right side of the display>

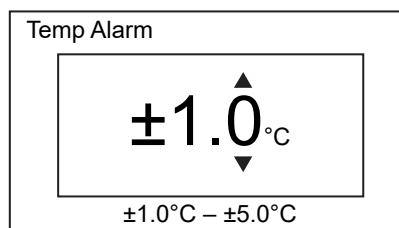

<Right side of the display> [Fig. 4]

7. Press the menu key (MENU/HOME) to display the home screen.

◇ The display returns to the home screen automatically when 90 seconds has passed without any key operation.

ALARM PARAMETERS

Setting temperature alarm delay

This function delays the activation of the temperature alarm for the preset amount of time.

- Settable range: 0 – 15 minutes
- Factory setting: 15 minutes

1. On the home screen, press the menu key (MENU/HOME).
▶ The left side of the display changes to the Menu screen.
2. On the Menu screen, move the cursor to Alarms & Controls [Fig. 1] using the up/down keys ($\Delta \nabla$), and press the enter key (ENTER).
▶ The display changes to the Alarms & Controls screen.

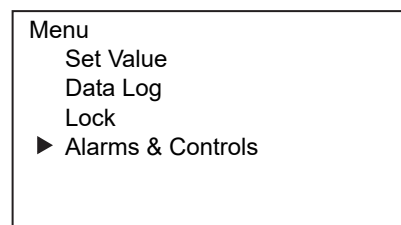

<Left side of the display> [Fig. 1]

3. When the cursor in the Alarms & Controls screen is on Temp/Gas Alarm Set [Fig. 2], press the enter key (ENTER).
▶ The display changes to the Temp/Gas Alarm Set screen.

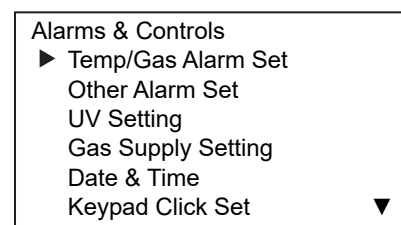

<Left side of the display> [Fig. 2]

4. On the Temp/Gas Alarm Set screen, move the cursor to Temp Alarm Delay [Fig. 3] using the up/down keys ($\Delta \nabla$), and press the enter key (ENTER).
▶ The right side of the display changes to the Temp Alarm Delay screen, and the current setting value (15) is displayed [Fig. 4].

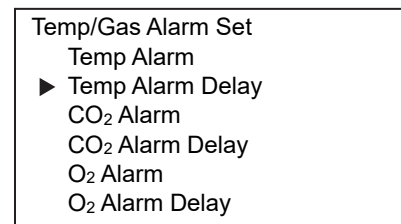

<Left side of the display> [Fig. 3]

5. Move the cursor using the left/right keys ($\triangleleft \triangleright$) and select the digit you want to change, and then use the up/down keys ($\Delta \nabla$) to change the number.

6. Press the enter key (ENTER).
▶ The value is confirmed and the display returns to the Temp/Gas Alarm Set screen.

*If the entered setting value is out of the settable range, the following message is displayed on the right side of the display. Press any key on the control panel to change to the Temp Alarm Delay screen [Fig. 4].

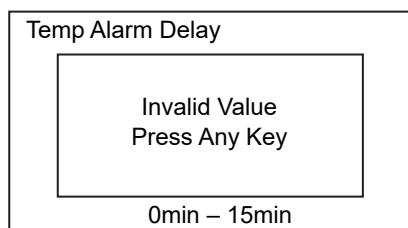

<Right side of the display>

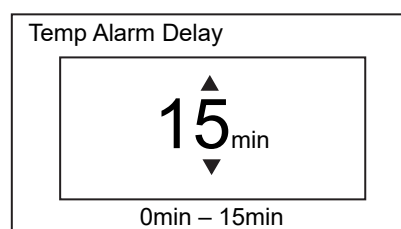

<Right side of the display> [Fig. 4]

7. Press the menu key (MENU/HOME) to display the home screen.
◇ The display returns to the home screen automatically when 90 seconds has passed without any key operation.

Note: When the incubator is recovered from the alarm state within the set alarm delay time, the buzzer doesn't sound after the elapse of the set alarm delay time.

ALARM PARAMETERS

Setting CO₂ density alarm

When the CO₂ density goes out of the preset range (the set CO₂ density \pm the set CO₂ density alarm value), the alarm activates.

- Settable range: $\pm 0.5\%$ – $\pm 5.0\%$
- Factory setting: $\pm 1.0\%$

1. On the home screen, press the menu key (MENU/HOME).

▶ The left side of the display changes to the Menu screen.

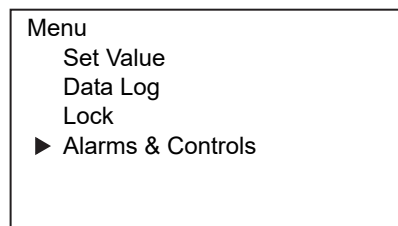

<Left side of the display> [Fig. 1]

2. On the Menu screen, move the cursor to Alarms & Controls [Fig. 1] using the up/down keys ($\Delta \nabla$), and press the enter key (ENTER).

▶ The display changes to the Alarms & Controls screen.

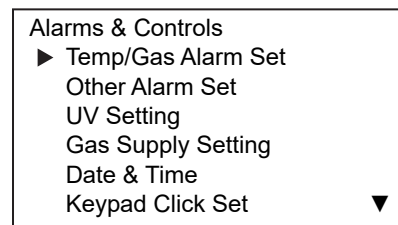

<Left side of the display> [Fig. 2]

3. When the cursor in the Alarms & Controls screen is on Temp/Gas Alarm Set [Fig. 2], press the enter key (ENTER).

▶ The display changes to the Temp/Gas Alarm Set screen.

4. On the Temp/Gas Alarm Set screen, move the cursor to CO₂ Alarm [Fig. 3] using the up/down keys ($\Delta \nabla$), and press the enter key (ENTER).

▶ The right side of the display changes to the CO₂ Alarm screen, and the current setting value (± 1.0) is displayed [Fig. 4].

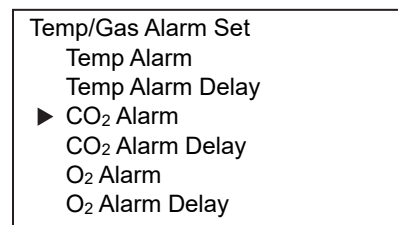

<Left side of the display> [Fig. 3]

5. Move the cursor using the left/right keys ($\triangleleft \triangleright$) and select the digit you want to change, and then use the up/down keys ($\Delta \nabla$) to change the number.

6. Press the enter key (ENTER).

▶ The value is confirmed and the display returns to the Temp/Gas Alarm Set screen.

*If the entered setting value is out of the settable range, the following message is displayed on the right side of the display. Press any key on the control panel to change to the CO₂ Alarm screen [Fig. 4].

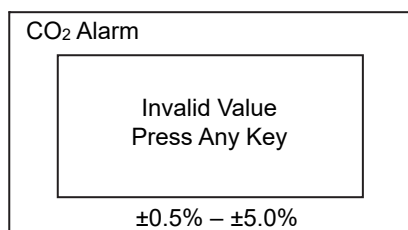

<Right side of the display>

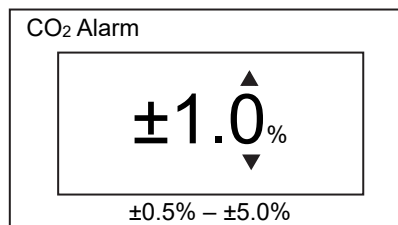

<Right side of the display> [Fig. 4]

7. Press the menu key (MENU/HOME) to display the home screen.

◇ The display returns to the home screen automatically when 90 seconds has passed without any key operation.

ALARM PARAMETERS

Setting CO₂ density alarm delay

This function delays the activation of the CO₂ density alarm for the preset amount of time.

- Settable range: 0 – 15 minutes
- Factory setting: 15 minutes

1. On the home screen, press the menu key (MENU/HOME).
▶ The left side of the display changes to the Menu screen.
2. On the Menu screen, move the cursor to Alarms & Controls [Fig. 1] using the up/down keys (Δ / ∇), and press the enter key (ENTER).
▶ The display changes to the Alarms & Controls screen.
3. When the cursor in the Alarms & Controls screen is on Temp/Gas Alarm Set [Fig. 2], press the enter key (ENTER).
▶ The display changes to the Temp/Gas Alarm Set screen.
4. On the Temp/Gas Alarm Set screen, move the cursor to CO₂ Alarm Delay [Fig. 3], and press the enter key (ENTER).
▶ The right side of the display changes to the CO₂ Alarm Delay screen, and the current setting value (15) is displayed [Fig. 4].
5. Move the cursor using the left/right keys (\triangleleft / \triangleright) and select the digit you want to change, and then use the up/down keys (Δ / ∇) to change the number.
6. Press the enter key (ENTER).
▶ The value is confirmed and the display returns to the Temp/Gas Alarm Set screen.

*If the entered setting value is out of the settable range, the following message is displayed on the right side of the display. Press any key on the control panel to change to the CO₂ Alarm Delay screen [Fig. 4].

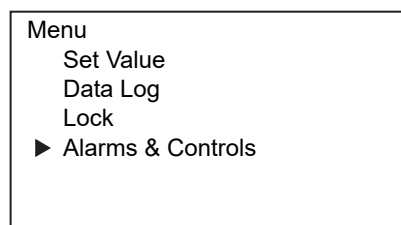

<Left side of the display> [Fig. 1]

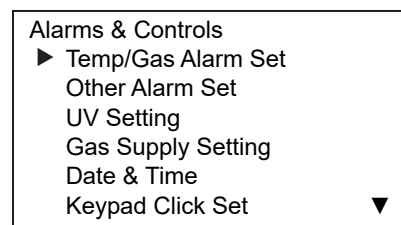

<Left side of the display> [Fig. 2]

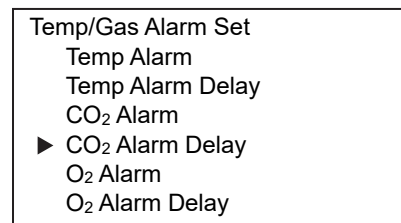

<Left side of the display> [Fig. 3]

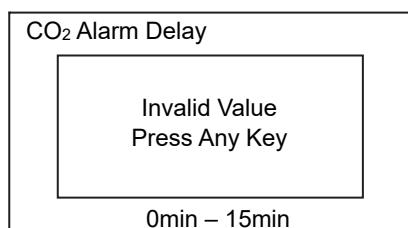

<Right side of the display>

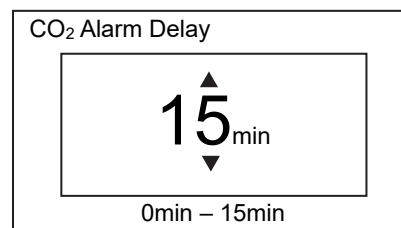

<Right side of the display> [Fig. 4]

7. Press the menu key (MENU/HOME) to display the home screen.
◇ The display returns to the home screen automatically when 90 seconds has passed without any key operation.

Note: When the incubator is recovered from the alarm state within the set alarm delay time, the buzzer doesn't sound after the elapse of the set alarm delay time.

ALARM PARAMETERS

Setting O₂ density alarm

When the O₂ density goes out of the preset range (the set O₂ density \pm the set O₂ density alarm value), the alarm activates.

- Settable range: $\pm 0.5\%$ – $\pm 5.0\%$
- Factory setting: $\pm 1.0\%$

1. On the home screen, press the menu key (MENU/HOME).
▶ The left side of the display changes to the Menu screen.
2. On the Menu screen, move the cursor to Alarms & Controls [Fig. 1] using the up/down keys ($\Delta \nabla$), and press the enter key (ENTER).
▶ The display changes to the Alarms & Controls screen.
3. When the cursor in the Alarms & Controls screen is on Temp/Gas Alarm Set [Fig. 2], press the enter key (ENTER).
▶ The display changes to the Temp/Gas Alarm Set screen.
4. On the Temp/Gas Alarm Set screen, move the cursor to O₂ Alarm [Fig. 3] using the up/down keys ($\Delta \nabla$), and press the enter key (ENTER).
▶ The right side of the display changes to the O₂ Alarm screen, and the current setting value (± 1.0) is displayed [Fig. 4].
5. Move the cursor using the left/right keys ($\triangleleft \triangleright$) and select the digit you want to change, and then use the up/down keys ($\Delta \nabla$) to change the number.
6. Press the enter key (ENTER).
▶ The value is confirmed and the display returns to the Temp/Gas Alarm Set screen.

*If the entered setting value is out of the settable range, the following message is displayed on the right side of the display: Press any key on the control panel to change to the O₂ Alarm screen [Fig. 4].

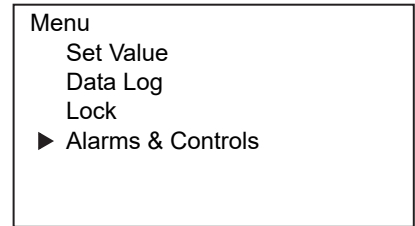

<Left side of the display> [Fig. 1]

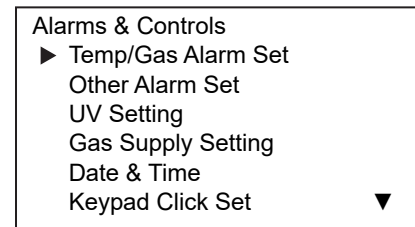

<Left side of the display> [Fig. 2]

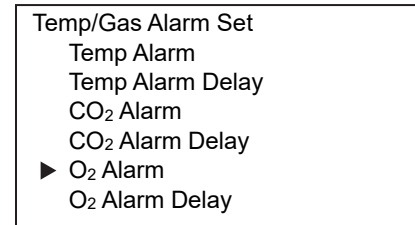

<Left side of the display> [Fig. 3]

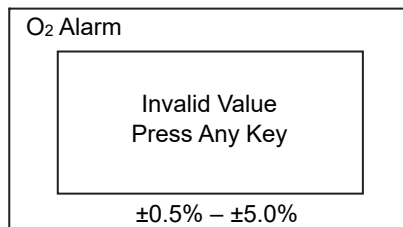

<Right side of the display>

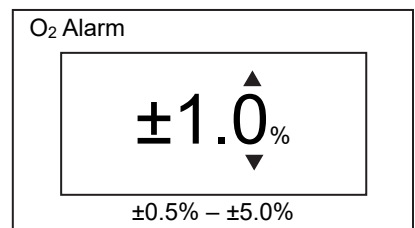

<Right side of the display> [Fig. 4]

7. Press the menu key (MENU/HOME) to display the home screen.
◇ The display returns to the home screen automatically when 90 seconds has passed without any key operation.

ALARM PARAMETERS

Setting O₂ density alarm delay

This function delays the activation of the O₂ density alarm for the preset amount of time.

- Settable range: 0 – 60 minutes
- Factory setting: 30 minutes

1. On the home screen, press the menu key (MENU/HOME).
▶ The left side of the display changes to the Menu screen.
2. On the Menu screen, move the cursor to Alarms & Controls [Fig. 1] using the up/down keys (Δ / ∇), and press the enter key (ENTER).
▶ The display changes to the Alarms & Controls screen.
3. When the cursor in the Alarms & Controls screen is on Temp/Gas Alarm Set [Fig. 2], press the enter key (ENTER).
▶ The display changes to the Temp/Gas Alarm Set screen.
4. On the Temp/Gas Alarm Set screen, move the cursor to O₂ Alarm Delay [Fig. 3], and press the enter key (ENTER).
▶ The right side of the display changes to the O₂ Alarm Delay screen, and the current setting value (30) is displayed [Fig. 4].
5. Move the cursor using the left/right keys (\triangleleft / \triangleright) and select the digit you want to change, and then use the up/down keys (Δ / ∇) to change the number.
6. Press the enter key (ENTER).
▶ The value is confirmed and the display returns to the Temp/Gas Alarm Set screen.

*If the entered setting value is out of the settable range, the following message is displayed on the right side of the display. Press any key on the control panel to change to the O₂ Alarm Delay screen [Fig. 4].

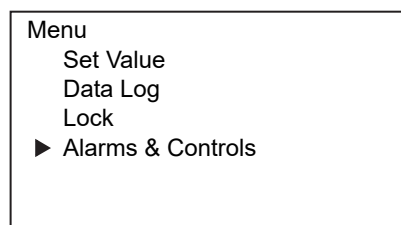

<Left side of the display> [Fig. 1]

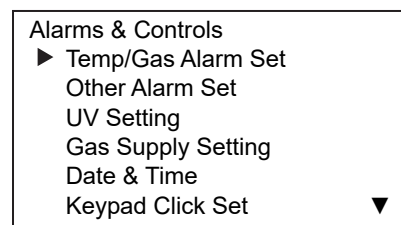

<Left side of the display> [Fig. 2]

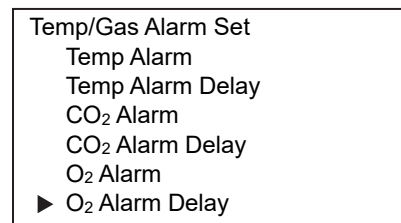

<Left side of the display> [Fig. 3]

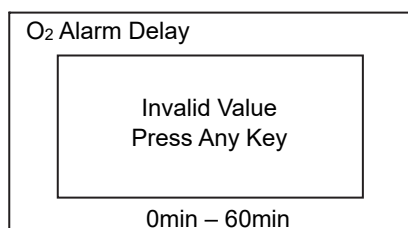

<Right side of the display>

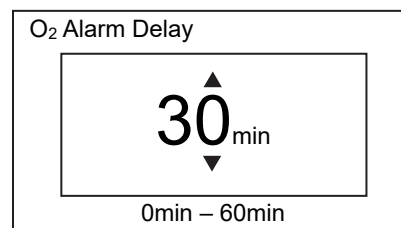

<Right side of the display> [Fig. 4]

7. Press the menu key (MENU/HOME) to display the home screen.
◇ The display returns to the home screen automatically when 90 seconds has passed without any key operation.

Note: When the incubator is recovered from the alarm state within the set alarm delay time, the buzzer doesn't sound after the elapse of the set alarm delay time.

ALARM PARAMETERS

Setting door alarm delay

This function delays the activation of the door alarm for the preset amount of time.

- Settable range: 1 – 30 minutes
- Factory setting: 2 minutes

1. On the home screen, press the menu key (MENU/HOME).

▶ The left side of the display changes to the Menu screen.

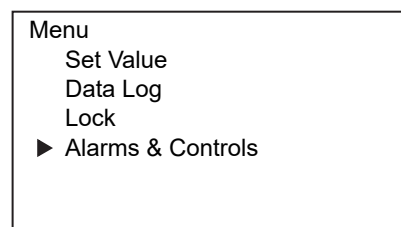

<Left side of the display> [Fig. 1]

2. On the Menu screen, move the cursor to Alarms & Controls [Fig. 1] using the up/down keys ($\Delta\nabla$), and press the enter key (ENTER).

▶ The display changes to the Alarms & Controls screen.

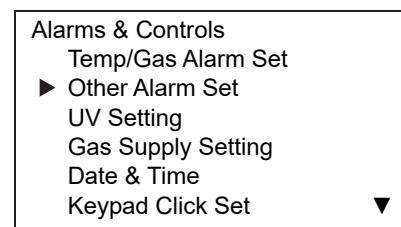

<Left side of the display> [Fig. 2]

3. On the Alarms & Controls screen, move the cursor to Other Alarm Set [Fig. 2] using the up/down keys ($\Delta\nabla$), and press the enter key (ENTER).

▶ The display changes to the Other Alarm Set screen.

4. When the cursor in the Other Alarm Set screen is on Door Alarm Delay [Fig. 3], press the enter key (ENTER).

▶ The right side of the display changes to the Door Alarm Delay screen, and the current setting value (02) is displayed [Fig. 4].

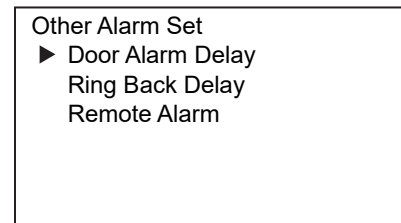

<Left side of the display> [Fig. 3]

5. Move the cursor using the left/right keys ($\triangleleft\triangleright$) and select the digit you want to change, and then use the up/down keys ($\Delta\nabla$) to change the number.

6. Press the enter key (ENTER).

▶ The value is confirmed and the display returns to the Other Alarm Set screen.

*If the entered setting value is out of the settable range, the following message is displayed on the right side of the display. Press any key on the control panel to change to the Door Alarm Delay screen [Fig. 4].

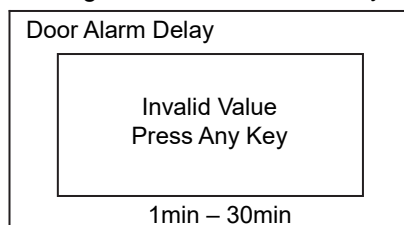

<Right side of the display>

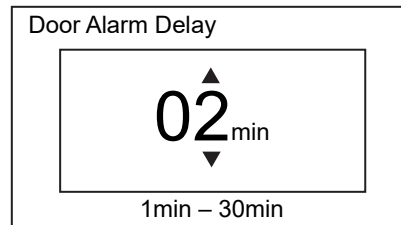

<Right side of the display> [Fig. 4]

7. Press the menu key (MENU/HOME) to display the home screen.

◇The display returns to the home screen automatically when 90 seconds has passed without any key operation.

Note: When the incubator is recovered from the alarm state within the set door alarm delay time, the buzzer doesn't sound after the elapse of the set door alarm delay time.

ALARM PARAMETERS

Setting ring back delay

This function reactivates the alarm when the alarm state still continues and preset amount of time has elapsed after the BUZZER STOP key was pressed to stop the alarm buzzer.

- Settable range: 0 – 99 minutes (when the setting is 0 minutes, the Ring Back Delay becomes “OFF.”)
- Factory setting: 30 minutes

1. On the home screen, press the menu key (MENU/HOME).

▶ The left side of the display changes to the Menu screen.

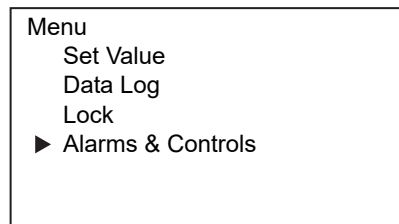

<Left side of the display> [Fig. 1]

2. On the Menu screen, move the cursor to Alarms & Controls [Fig. 1] using the up/down keys (Δ / ∇), and press the enter key (ENTER).

▶ The display changes to the Alarms & Controls screen.

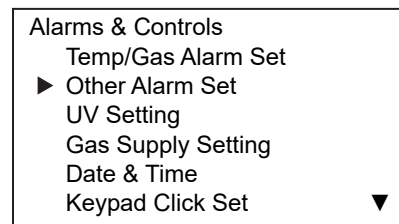

<Left side of the display> [Fig. 2]

3. On the Alarms & Controls screen, move the cursor to Other Alarm Set [Fig. 2] using the up/down keys (Δ / ∇), and press the enter key (ENTER).

▶ The display changes to the Other Alarm Set screen.

4. On the Other Alarm Set screen, move the cursor to Ring Back Delay [Fig. 3] using the up/down keys (Δ / ∇), and press the enter key (ENTER).

▶ The right side of the display changes to the Ring Back Delay screen, and the current setting value (30) is displayed [Fig. 4].

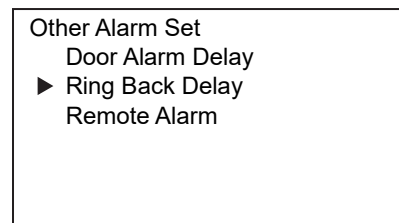

<Left side of the display> [Fig. 3]

5. Move the cursor using the left/right keys (\triangleleft / \triangleright) and select the digit you want to change, and then use the up/down keys (Δ / ∇) to change the number.

6. Press the enter key (ENTER).

▶ The value is confirmed and the display returns to the Other Alarm Set screen.

7. Press the menu key (MENU/HOME) to display the home screen.

◇ The display returns to the home screen automatically when 90 seconds has passed without any key operation.

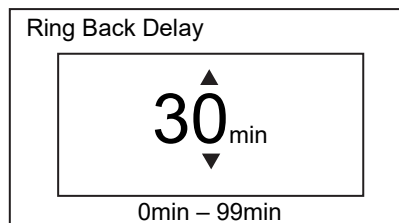

<Right side of the display> [Fig. 4]

Note: In the case of Err01 (CO₂ gas cylinder empty), Err11 and Err12 (CO₂ sensor error) or Door alarm, the alarm does not reactivate because the alarm itself is canceled by pressing the BUZZER STOP key. Also, in the case of Err18 (UV lamp failure), the alarm does not reactivate if the BUZZER STOP key is pressed after the UV lamp ON period is over (refer to page 90).

ALARM PARAMETERS

Setting remote alarm

You can set the behavior of the remote alarm when the BUZZER STOP key on the incubator unit is pressed. When set to ON (not linked): The alarm on the remote alarm device does not stop even when the alarm BUZZER STOP key is pressed during the alarm buzzer activation.

When set to OFF (linked): The alarm on the remote alarm device stops when the alarm BUZZER STOP key is pressed during the alarm buzzer activation.

- Setting value: ON (not linked) or OFF (linked)
- Factory setting: ON

1. On the home screen, press the menu key (MENU/HOME).

▶ The left side of the display changes to the Menu screen.

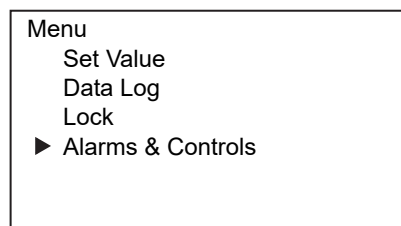

<Left side of the display> [Fig. 1]

2. On the Menu screen, move the cursor to Alarms & Controls [Fig. 1] using the up/down keys (Δ ∇), and press the enter key (ENTER).

▶ The display changes to the Alarms & Controls screen.

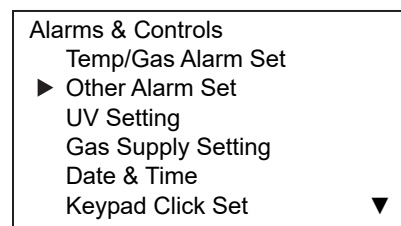

<Left side of the display> [Fig. 2]

3. On the Alarms & Controls screen, move the cursor to Other Alarm Set [Fig. 2] using the up/down keys (Δ ∇), and press the enter key (ENTER).

▶ The display changes to the Other Alarm Set screen.

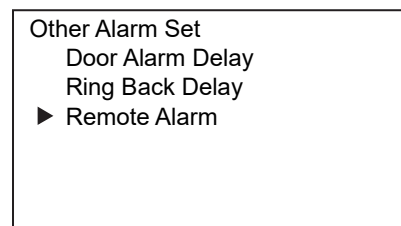

<Left side of the display> [Fig. 3]

4. On the Other Alarm Set screen, move the cursor to Remote Alarm [Fig. 3] using the up/down keys (Δ ∇), and press the enter key (ENTER).

▶ The right side of the display changes to the Remote Alarm screen, and the current setting value (ON) is displayed [Fig. 4].

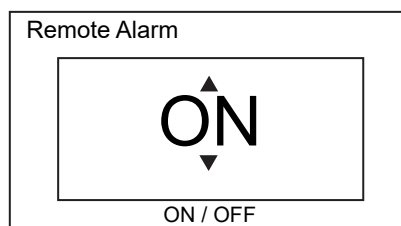

<Right side of the display> [Fig. 4]

5. Use the up/down keys (Δ ∇) to change the remote alarm setting value.

✧ Each time the up/down key is pressed the value changes between ON and OFF.

6. Press the enter key (ENTER).

▶ The value is confirmed and the display returns to the Other Alarm Set screen.

7. Press the menu key (MENU/HOME) to display the home screen.

✧ The display returns to the home screen automatically when 90 seconds has passed without any key operation.

UV LAMP (OPTION)

When the optional UV System MCO-170UVS is installed on the model MCO-50M, the UV lamp lights for preset amount of time after closing the outer door to disinfect the water in the humidifying pan and the air circulating in the chamber.

Using UV lamp

1. Set all inner attachments in the chamber properly, and place the cultivation samples on the trays.

Note: Improper setting of the inner attachments adversely affects the chamber temperature distribution and humidity recovery performance.

2. Close the outer door. The UV lamp will light for the preset amount of time*¹.

Notes:

- If you open the outer door while the UV lamp is ON, the lamp will be turned OFF. When you close the door again, the lamp will light for the preset amount of time*¹.
- Repeated opening and closing of the outer door may adversely affect the condensation in the chamber and the chamber temperature distribution because the UV lamp generates heat for a long time. It may also shorten the service life of the UV lamp.
- UV lamp ON period can be changed (refer to page 71).
- UV light is harmful to the eyes. Do not turn the UV lamp ON when the inner door is open.

3. If the outer door is not opened for at least 12 consecutive hours, then the UV lamp lights every 12 hours for the preset amount of time*¹.

Note: Opening the outer door will reset the 12-hour period.

● The recommended replacement time for the UV lamp (i.e., when the UV output ratio drops to 60 %–70 % of its initial value) is when the accumulated ON time reaches 5,000 hours. The message “Warning: UV Bulb Life” then appears in the message display area. Replace the UV lamp promptly at this point. Contact our sales representative or agent for replacement.

● If the UV lamp burns out, “Err18: UV Lamp Abnormal” is displayed in the message display area. Replace the UV lamp, and replace the glow starter (type FG-7P or FG-7PL) at the same time. Contact our sales representative or agent for replacement.

*1: The time set for UV Lighting Time + the time extended by the Auto-Extended Time. Refer to page 71 and 73.

UV LAMP (OPTION)

Setting UV lamp ON period

To change the UV lamp ON period, follow the procedure below.

- Settable range: 0 – 30 minutes
- Factory setting: 10 minutes

Notes:

- The recommended UV lighting time (UV Lighting Time) is 10 minutes. Less than 10 minutes may reduce the bactericidal effect.
- When set to 0 minutes, the UV lamp does not light up.

1. On the home screen, press the menu key (MENU/HOME).

- ▶ The left side of the display changes to the Menu screen.

2. On the Menu screen, move the cursor to Alarms & Controls [Fig. 1] using the up/down keys ($\Delta \nabla$), and press the enter key (ENTER).

- ▶ The display changes to the Alarms & Controls screen.

3. On the Alarms & Controls screen, move the cursor to UV Setting [Fig. 2] using the up/down keys ($\Delta \nabla$), and press the enter key (ENTER).

- ▶ The display changes to the UV Setting screen.

4. With the cursor in the UV Setting screen on UV Lighting Time [Fig. 3], press the enter key (ENTER).

- ▶ The right side of the display changes to the UV Lighting Time screen, and the current setting value (10) is displayed [Fig. 4].

5. Move the cursor using the left/right keys ($\triangleleft \triangleright$) and select the digit you want to change, and then use the up/down keys ($\Delta \nabla$) to change the number.

6. Press the enter key (ENTER).

- ▶ The value is confirmed and the display returns to the UV Setting screen.

*If the entered setting value is out of the settable range, the following message is displayed on the right side of the display. Press any key on the control panel to return to the UV Lighting Time screen [Fig. 4].

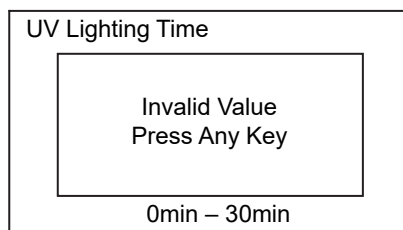

<Right side of the display>

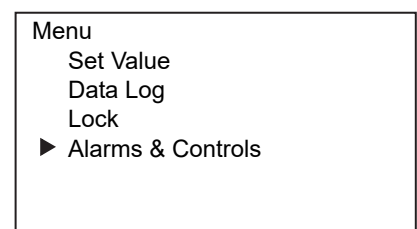

<Left side of the display> [Fig. 1]

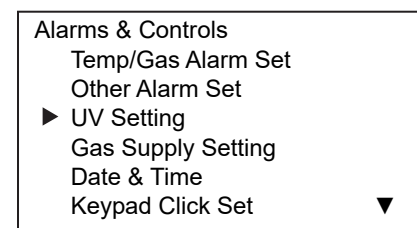

<Left side of the display> [Fig. 2]

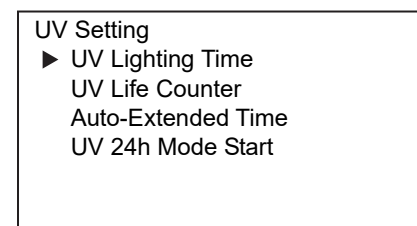

<Left side of the display> [Fig. 3]

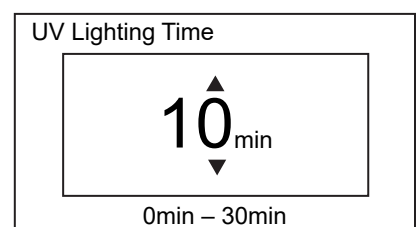

<Right side of the display> [Fig. 4]

7. Press the menu key (MENU/HOME) to display the home screen.

- ◇ The display returns to the home screen automatically when 90 seconds has passed without any key operation.

UV LAMP (OPTION)

UV lamp life indication

The amount of time the UV lamp has been used up to now relative to the total amount of time recommended for the replacement of the UV lamp (5,000 hours) is displayed in percentage (%).

1. On the home screen, press the menu key (MENU/HOME).
▶ The left side of the display changes to the Menu screen.
2. On the Menu screen, move the cursor to Alarms & Controls [Fig. 1] using the up/down keys (Δ / ∇), and press the enter key (ENTER).
▶ The display changes to the Alarms & Controls screen.
3. On the Alarms & Controls screen, move the cursor to UV Setting [Fig. 2] using the up/down keys (Δ / ∇), and press the enter key (ENTER).
▶ The display changes to the UV Setting screen.
4. On the UV Setting screen, move the cursor to UV Life Counter [Fig. 3] using the up/down keys (Δ / ∇), and press the enter key (ENTER).
▶ The right side of the display changes to the UV Life Counter screen, and the current cumulative UV lighting time is displayed [Fig. 4].
5. Press the enter key (ENTER).
▶ The display returns to the UV Setting screen.
6. Press the menu key (MENU/HOME) to display the home screen.
◇ The display returns to the home screen automatically when 90 seconds has passed without any key operation.

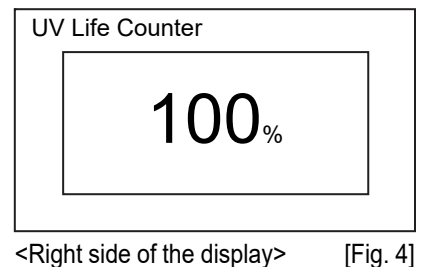
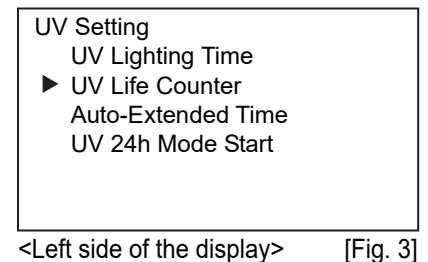
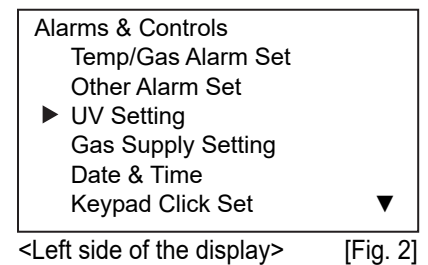
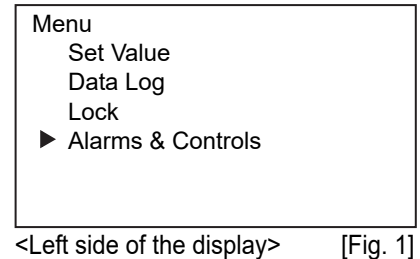

UV LAMP (OPTION)

Automatic extension of UV lamp ON period

The amount of UV irradiation decreases as the total UV lamp ON period increases. To compensate for this, UV lamp ON period is automatically extended as the total UV lamp ON period increases (the value set for UV Lighting Time is not changed).

- Settable range: 0% – 40% (cannot be set)

Example) UV Lighting Time: 10 minutes plus Auto-Extended Time: 10 % → UV lamp lights for 11 minutes.

1. On the home screen, press the menu key (MENU/HOME).
▶ The left side of the display changes to the Menu screen.
2. On the Menu screen, move the cursor to Alarms & Controls [Fig. 1] using the up/down keys (Δ / ∇), and press the enter key (ENTER).
▶ The display changes to the Alarms & Controls screen.
3. On the Alarms & Controls screen, move the cursor to UV Setting [Fig. 2] using the up/down keys (Δ / ∇), and press the enter key (ENTER).
▶ The display changes to the UV Setting screen.
4. On the UV Setting screen, move the cursor to Auto-Extended Time (Fig. 3) using the up/down keys (Δ / ∇), and press the enter key (ENTER).
▶ The right side of the display changes to the Auto-Extended Time screen, and the current UV lighting time's automatic extension ratio is displayed [Fig. 4].
5. Press the enter key (ENTER).
▶ The display returns to the UV Setting screen.
6. Press the menu key (MENU/HOME) to display the home screen.
◇ The display returns to the home screen automatically when 90 seconds has passed without any key operation.

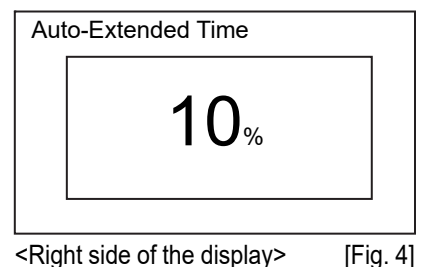
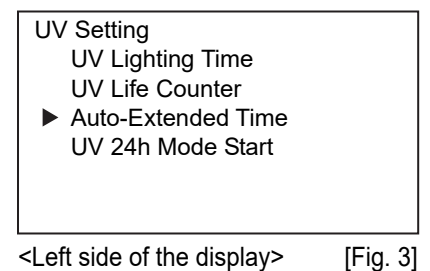
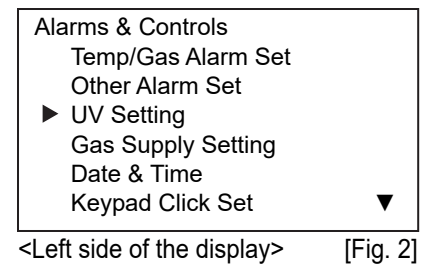
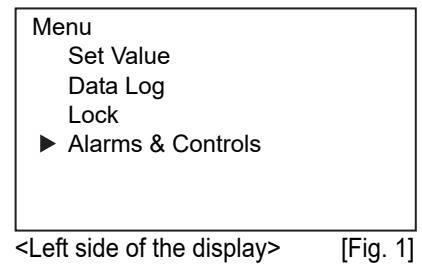

UV LAMP (OPTION)

Lighting UV lamp for 24 hours

If contamination occurs in the chamber due to accumulation of dirt or the culture medium being scattered etc., sterilize it by 24-hour continuous UV irradiation as described in the following procedure:

- Setting values: ON or OFF
- Factory setting: OFF

1. Remove the inner attachments (trays, fan cover, duct, fan, humidifying pan, gas injection nozzle, and gas injection nozzle tube). Clean the internal items with autoclave sterilization or alcohol for disinfection and wipe off the contaminant.

2. Clean the interior with alcohol for disinfection, wipe off the contaminant and close the outer door.

3. Set the CO₂ density to OFF and O₂ density to OFF (see pages 35, 37).

4. On the home screen, press the menu key (MENU/HOME).

▶ The left side of the display changes to the Menu screen.

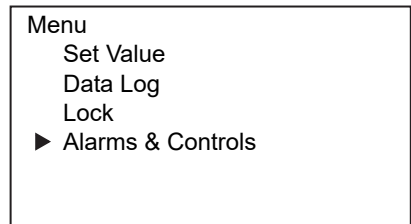

<Left side of the display> [Fig. 1]

5. On the Menu screen, move the cursor to Alarms & Controls [Fig. 1] using the up/down keys ($\Delta \nabla$), and press the enter key (ENTER).

▶ The display changes to the Alarms & Controls screen.

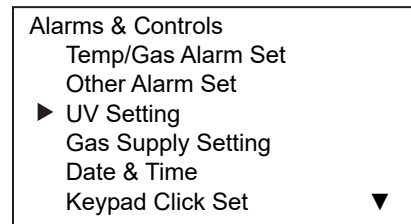

<Left side of the display> [Fig. 2]

6. On the Alarms & Controls screen, move the cursor to UV Setting [Fig. 2] using the up/down keys ($\Delta \nabla$), and press the enter key (ENTER).

▶ The display changes to the UV Setting screen.

7. On the UV Setting screen, move the cursor to UV 24h Mode Start [Fig. 3] using the up/down keys ($\Delta \nabla$), and press the enter key (ENTER).

▶ The right side of the display changes to the UV 24h Mode Start setting screen, and the current setting value (OFF) is displayed [Fig. 4].

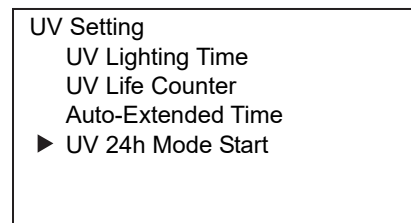

<Left side of the display> [Fig. 3]

8. Use the up/down keys ($\Delta \nabla$) to change the UV 24h lighting mode setting value to ON.

✧ Each time the up/down key is pressed the value changes between ON and OFF.

9. Press the enter key (ENTER).

▶ The value is confirmed, the display returns to the UV Setting screen, and the UV 24-hour lighting mode will start.

Reference: When the UV lamp is lit. "UV:ON" is displayed on the UV lamp status display.

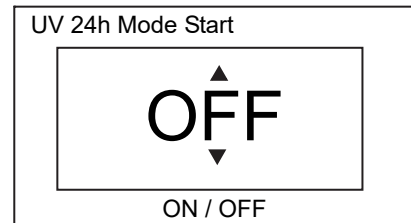

<Right side of the display> [Fig. 4]

10. Press the menu key (MENU/HOME) to display the home screen.

✧ The display returns to the home screen automatically when 90 seconds has passed without any key operation.

Notes:

- During the UV 24-hour mode, the temperature alarm may activate due to the rising temperature in the chamber.
- If you open the outer door after the step 9 when UV lamp is ON, UV lamp is turned OFF and UV 24-hour mode is canceled. Follow the procedure again from step 4 to start the UV 24-hour mode again.

11. After 24 hours, the UV lamp turns off automatically and you can reinstall the removed interior items.

GAS AUTO CHANGER (OPTION)

When the optional gas auto changer MCO-50GC is installed, two connecting ports for CO₂ gas pipes, A and B are available. If two CO₂ gas cylinders are connected, the CO₂ gas supply line can be switched when one of the CO₂ gas cylinders becomes empty.

Connecting CO₂ gas cylinders

1. Prepare two CO₂ gas cylinders (CO₂ gas cylinder A and B) and attach the optional gas regulators MCO-010R to both of the CO₂ gas cylinders.

Notes:

- Use a liquefied CO₂ gas cylinder (at least 99.5 % pure). The siphon (dip tube) type cannot be used.
- When MCO-010R is not available, attach gas regulators rated at 25 MPa(G) (250 kgf/cm²(G), 3,600 psi(G)) for the primary side, and 0.25 MPa(G) (2.5 kgf/cm²(G), 36 psi(G)) for the secondary side.

2. Connect the connecting port A for CO₂ gas pipe and the gas regulator for the CO₂ gas cylinder A using the included gas tube.

3. Connect the connecting port B for CO₂ gas pipe and the gas regulator of the CO₂ gas cylinder B using the included gas tube.

Note: For connecting and removing the tube and for connecting to the gas regulator MCO-010R, refer to pages 19-20.

Note: If the CO₂ gas is supplied to multiple O₂/CO₂ incubators from a single gas cylinder, a CO₂ solid will be formed in the gas regulator. The gas regulator safety valve will operate, and it may make an explosive sound.

4. After connecting the gas tube, make sure that no gas is leaking (ex. by using a gas leak detection spray).

5. For both CO₂ gas cylinders A and B, adjust the secondary side pressure of the gas regulator to 0.03MPa(G) –0.1 MPa(G) (0.3 kgf/cm²(G) –1 kgf/cm²(G), 4.4 psi(G) –14.5 psi(G)) while CO₂ gas is injecting.

Recommended pressure: 0.03 MPa (0.3 kgf/cm²(G), 4.4 psi(G)).

Notes:

- As the pressure increases, the CO₂ gas density control range will increase. Excessive pressure may cause gas supply lines inside the incubator to come loose, which may result in gas poisoning or oxygen deprivation due to the escaping of gas. If gas lines come loose, the incubator must be repaired.
- Close the valve of the CO₂ gas cylinder when the CO₂ gas is not in use.

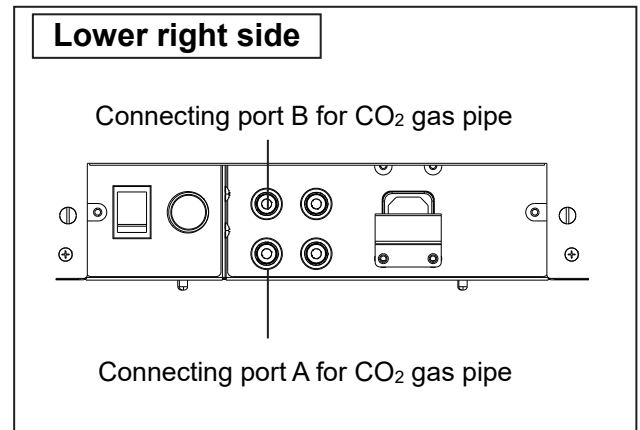

Automatic CO₂ gas supply line switching

When an optional gas auto changer MCO-50GC is installed, CO₂ gas supply line indicator A and B is displayed in the home screen. The CO₂ gas supply line currently in use is highlighted.

CO₂ gas supply line indicator A and B (CO₂ gas supply line currently in use)

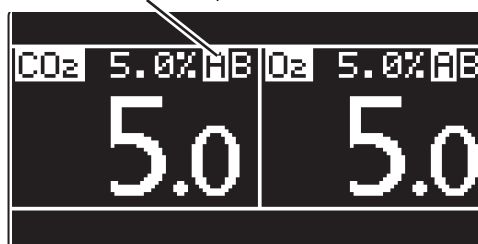











<Right side of the display>

GAS AUTO CHANGER (OPTION)

When the CO₂ density level in the chamber remains unchanged even though the CO₂ gas valve in the unit is open, the unit assumes the currently connected CO₂ gas cylinder to be empty and automatically switches the CO₂ gas supply line to the other one. The behavior in that case is shown in Table 4.

1. When there is gas remaining in cylinder A, the unit operates using CO₂ gas supplied from the CO₂ gas cylinder A (Situation 1).
2. When the CO₂ gas cylinder A is empty, the level of CO₂ density in the unit does not increase because gas is not supplied into the unit even though the gas valve in the unit is open (Situation 2).
3. When Situation 2 continues for 2 to 3 minutes, the gas supply line is automatically switched assuming the gas cylinder to be empty. At this time, the CO₂ gas empty alarm is activated, the buzzer sounds, and gas supply indicator A is displayed in reverse video and blinks (Situation 3).
4. Press the BUZZER STOP key to stop the CO₂ gas empty alarm. The gas supply indicator A stops blinking (Situation 4).
5. Replace the empty gas cylinder A with a new one immediately after the Situation 4 (Situation 5).
6. When the cylinder B becomes empty, the supply line is again switched to the cylinder A.

Table 4. CO₂ gas supply line automatic switching

Situation	CO ₂ gas			CO ₂ gas supply line indicator		Message display area
	Supply line	Cylinder A	Cylinder B	A	B	
1 CO ₂ gas is being supplied from cylinder A.	A	Remaining	Remaining	 Reverse video and light on	 Light on	----
2 CO ₂ density in the chamber does not increase even if CO ₂ gas valve is open.	A	Empty	Remaining	 Reverse video and light on	 Light on	----
3 CO ₂ gas supply line is automatically switched to cylinder B.	B	Empty	Remaining	 Blink	 Reverse video and light on	Err01: CO ₂ Gas Empty (and buzzer sound)
4 The BUZZER STOP key is pressed.	B	Empty	Remaining	 Light on	 Reverse video and light on	----
5 Empty gas cylinder A is replaced with a new one.	B	Remaining	Remaining	 Light on	 Reverse video and light on	----

Notes:

- When the BUZZER STOP key is not pressed in the Situation 4 and the CO₂ gas cylinder B gets empty without the CO₂ gas cylinder A being replaced in the Situation 5, the switch operation between CO₂ gas supply lines A and B will be repeated. In this case, replace the both CO₂ gas cylinders A and B with new ones immediately, and press the BUZZER STOP key.
- The switching of CO₂ cylinders is determined by an increase of CO₂ density in the chamber. The switching of CO₂ gas cylinders may also occur in the situations where the gas tube is clogged, the gas is leaking, the gas pressure has dropped down, or the valve on the gas cylinder is insufficiently open etc., even though the CO₂ gas cylinder being used is not empty.

GAS AUTO CHANGER (OPTION)

Manual CO₂ gas supply line A/B switching

The CO₂ gas supply lines A and B can be switched manually at any time.

- Setting values: A or B
- Factory setting: A

1. On the home screen, press the menu key (MENU/HOME).
 - ▶ The left side of the display changes to the Menu screen.
2. On the Menu screen, move the cursor to Alarms & Controls [Fig. 1] using the up/down keys (△▽), and press the enter key (ENTER).
 - ▶ The display changes to the Alarms & Controls screen.
3. On the Alarms & Controls screen, move the cursor to Gas Supply Setting [Fig. 2] using the up/down key (△▽), and press the enter key (ENTER).
 - ▶ The display changes to the Gas Supply Setting screen.
4. With the cursor on the Gas Supply Setting screen on CO₂ Supply [Fig. 3], press the enter key (ENTER).
 - ▶ The right side of the display changes to the CO₂ Supply Setting screen, and the current setting value (A) is displayed [Fig. 4].
5. Use the up/down keys (△▽) to change the CO₂ gas supply setting values.
 - ◇ Each time the up/down key is pressed the value changes between A and B.
6. Press the enter key (ENTER).
 - ▶ The value is confirmed and the display returns to the Gas Supply Setting screen.
7. Press the menu key (MENU/HOME) to display the home screen.
 - ◇ The display returns to the home screen automatically when 90 seconds has passed without any key operation.

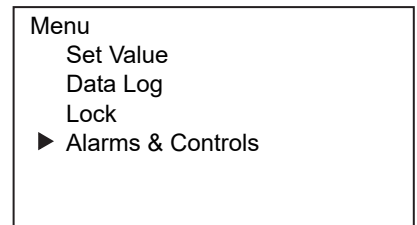

<Left side of the display> [Fig. 1]

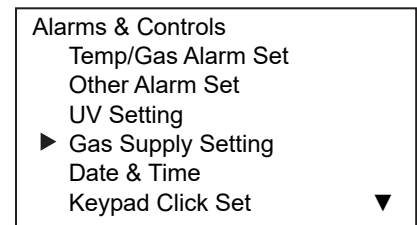

<Left side of the display> [Fig. 2]

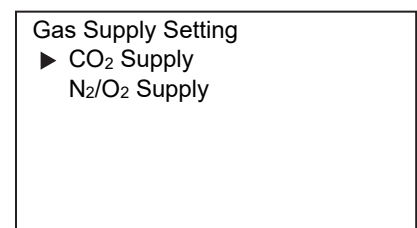



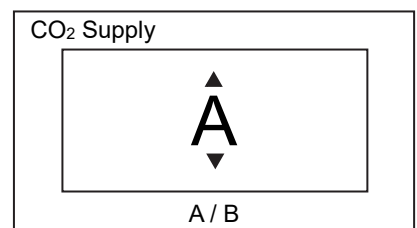

<Left side of the display> [Fig. 3]



<Right side of the display> [Fig. 4]

Note: Table 5 shows the behavior when the CO₂ gas supply line is switched using the CO₂ gas automatic switching function and then manually switched back to the empty CO₂ gas supply line before pressing the BUZZER STOP key.

Table 5. Manual switching from cylinder B to empty cylinder A

	Situation	CO ₂ gas			CO ₂ gas supply line indicator		Message display area
		Supply line	Cylinder A	Cylinder B	A	B	
1	Automatically switched to the supply line B.	B	Empty	Remaining	 Blink	 Reverse video and Light on	Err01: CO ₂ Gas Empty (and buzzer sound)
2	The BUZZER STOP key is not pressed and CO ₂ gas supply line was manually switched.	A	Empty	Remaining	 Reverse video and blink	 Light on	

OTHER PARAMETERS

Setting date display format

The date display format can be set as follows.

- Setting values: DD/MM/YY (Day/Month/Year) or YY/MM/DD (Year/Month/Day)
- Factory setting: DD/MM/YY

1. On the home screen, press the menu key (MENU/HOME).

▶ The left side of the display changes to the Menu screen.

2. On the Menu screen, move the cursor to Alarms & Controls [Fig. 1] using the up/down keys (Δ / ∇), and press the enter key (ENTER).

▶ The display changes to the Alarms & Controls screen.

3. On the Alarms & Controls screen, move the cursor to Date & Time [Fig. 2] using the up/down keys (Δ / ∇), and press the enter key (ENTER).

▶ The display changes to the Date & Time screen.

4. With the cursor in the Date & Time screen on Date Format [Fig. 3], press the enter key (ENTER).

▶ The right side of the display changes to the Date Format screen, and the current setting value (DD/MM/YY) is displayed [Fig. 4].

5. Use the up/down keys (Δ / ∇) to change the date format setting values.

◇ Each time the up/down key is pressed the value changes between YY/MM/DD and DD/MM/YY.

6. Press the enter key (ENTER).

▶ The input is confirmed and the display returns to the Date & Time screen.

7. Press the menu key (MENU/HOME) to display the home screen.

◇ The display returns to the home screen automatically when 90 seconds has passed without any key operation.

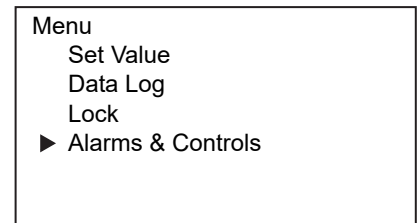

<Left side of the display> [Fig. 1]

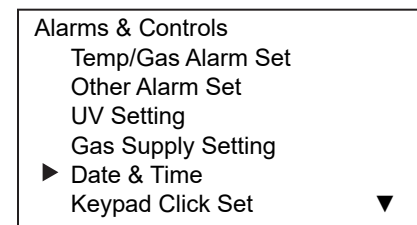

<Left side of the display> [Fig. 2]

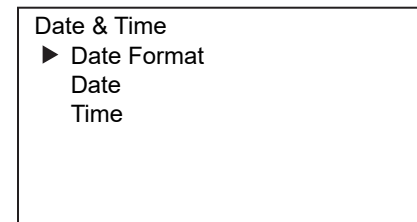

<Left side of the display> [Fig. 3]

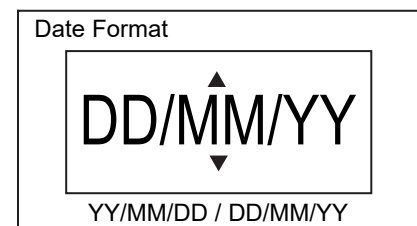

<Right side of the display> [Fig. 4]

OTHER PARAMETERS

Setting date

The date setting can be changed as follows.

1. On the home screen, press the menu key (MENU/HOME).
▶ The left side of the display changes to the Menu screen.
2. On the Menu screen, move the cursor to Alarms & Controls [Fig. 1] using the up/down keys ($\Delta \nabla$), and press the enter key (ENTER).
▶ The display changes to the Alarms & Controls screen.
3. On the Alarms & Controls screen, move the cursor to Date & Time [Fig. 2] using the up/down keys ($\Delta \nabla$), and press the enter key (ENTER).
▶ The display changes to the Date & Time screen.
4. On the Date & Time screen, move the cursor to Date [Fig. 3] using the up/down keys ($\Delta \nabla$), and press the enter key (ENTER).
▶ The right side of the display changes to the Date screen, and the current date (Year/Month/Date) is displayed [Fig. 4].

5. Move the cursor using the left/right keys ($\triangleleft \triangleright$) and select the digit you want to change, and then use the up/down keys ($\Delta \nabla$) to change the number.

Even when the date display format is DD/MM/YY, the numerical values can be changed in the same way.

6. Press the enter key (ENTER).
▶ The input is confirmed and the display returns to the Date & Time screen.

*When the entered date is out of the settable range, the following message is displayed on the right side of the display. Press any key on the control panel to change to the Date screen [Fig. 4].

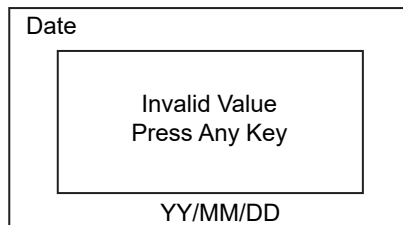

<Right side of the display>

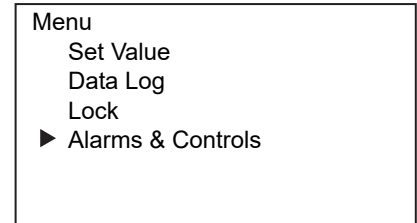

<Left side of the display> [Fig. 1]

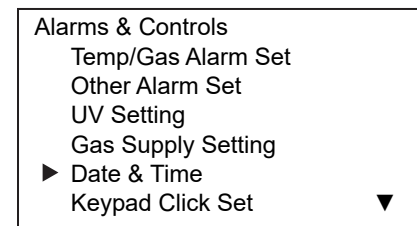

<Left side of the display> [Fig. 2]

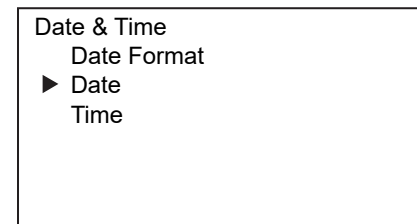

<Left side of the display> [Fig. 3]

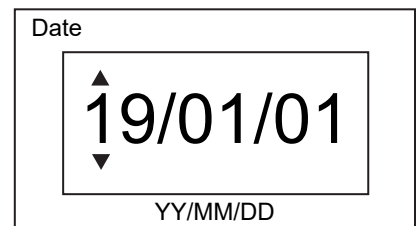

<Right side of the display> [Fig. 4]

7. Press the menu key (MENU/HOME) to display the home screen.

◇The display returns to the home screen automatically when 90 seconds has passed without any key operation.

OTHER PARAMETERS

Setting time

The time setting can be change as follows.

1. On the home screen, press the menu key (MENU/HOME).
▶ The left side of the display changes to the Menu screen.
2. On the Menu screen, move the cursor to Alarms & Controls [Fig. 1] using the up/down keys ($\Delta \nabla$), and press the enter key (ENTER).
▶ The display changes to the Alarms & Controls screen.
3. On the Alarms & Controls screen, move the cursor to Date & Time [Fig. 2] using the up/down keys ($\Delta \nabla$), and press the enter key (ENTER).
▶ The display changes to the Date & Time screen.
4. On the Date & Time screen, move the cursor to Time [Fig. 3] using the up/down keys ($\Delta \nabla$), and press the enter key (ENTER).
▶ The right side of the display changes to the Time screen, and the current time is displayed [Fig. 4].
5. Move the cursor using the left/right keys ($\triangleleft \triangleright$) and select the digit you want to change, and then use the up/down keys ($\Delta \nabla$) to change the number.
6. Press the enter key (ENTER).
▶ The input is confirmed and the display returns to the Date & Time screen.

*When the entered time is out of the settable range, the following message is displayed on the right side of the display. Press any key on the control panel to change to the Time screen [Fig. 4].

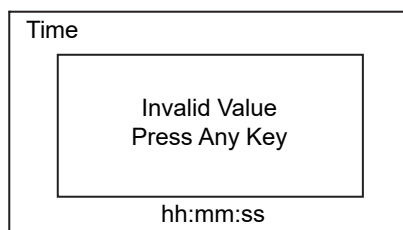

<Right side of the display>

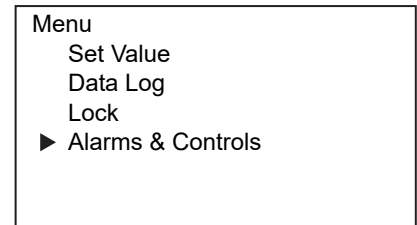

<Left side of the display> [Fig. 1]

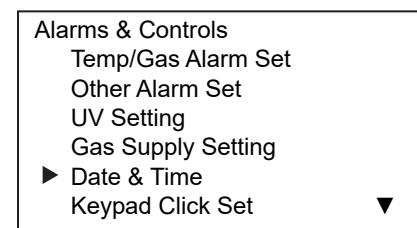

<Left side of the display> [Fig. 2]

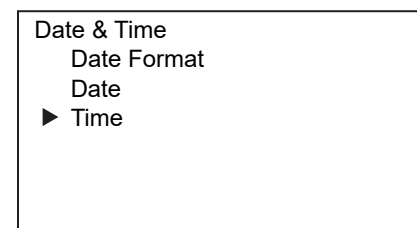

<Left side of the display> [Fig. 3]

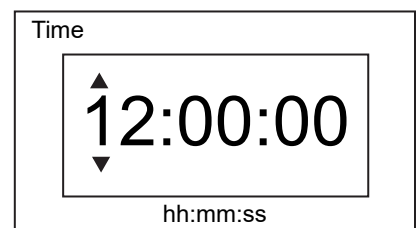

<Right side of the display> [Fig. 4]

7. Press the menu key (MENU/HOME) to display the home screen.
◇ The display returns to the home screen automatically when 90 seconds has passed without any key operation.

Notes:

- 24-hour clock.
- It is recommended to set the time periodically since the error of about 1 minute a month may be observed.

OTHER PARAMETERS

Setting keypad clicking sound

The key operation sound can be set as follows.

- Setting values: ON or OFF
- Factory setting: ON

1. On the home screen, press the menu key (MENU/HOME).

▶ The left side of the display changes to the Menu screen.

2. On the Menu screen, move the cursor to Alarms & Controls [Fig. 1] using the up/down keys (Δ / ∇), and press the enter key (ENTER).

▶ The display changes to the Alarms & Controls screen.

3. On the Alarms & Controls screen, move the cursor to Keypad Click Set [Fig. 2] using the up/down keys (Δ / ∇), and press the enter key (ENTER).

▶ The display changes to the Keypad Click Set screen.

4. With the cursor in the Keypad Click Set screen on Keypad Click Set [Fig. 3], press the enter key (ENTER).

The right side of the display changes to the Keypad Click Set screen, and the current setting value (ON) is displayed [Fig. 4].

5. Use the up/down keys (Δ / ∇) to change the key operation sound setting value.

◇ Each time the up/down key is pressed the value changes between ON and OFF.

6. Press the enter key (ENTER).

▶ The input is confirmed and the display returns to the Keypad Click Set screen.

7. Press the menu key (MENU/HOME) to display the home screen.

◇ The display returns to the home screen automatically when 90 seconds has passed without any key operation.

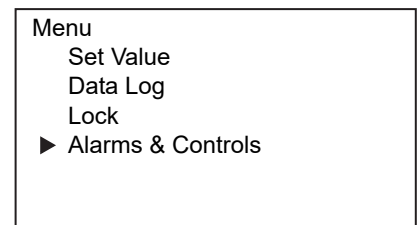

<Left side of the display> [Fig. 1]

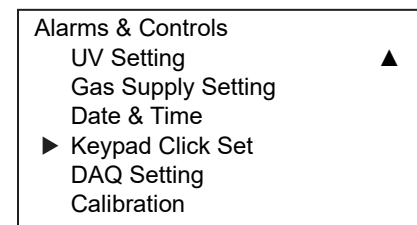

<Left side of the display> [Fig. 2]

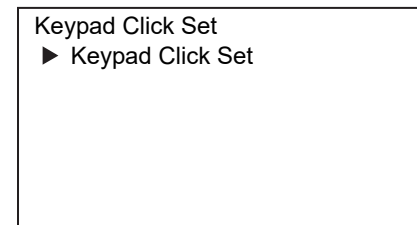

<Left side of the display> [Fig. 3]

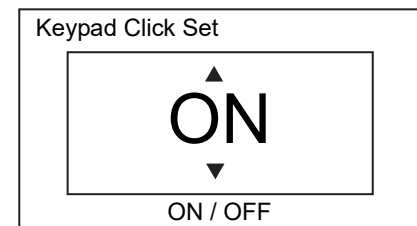

<Right side of the display> [Fig. 4]

H₂O₂ DECONTAMINATION (OPTION)

When the chamber is contaminated or when cleaning the chamber prior to starting a culture, H₂O₂ decontamination can be performed.

Prior to the H₂O₂ decontamination work, make sure that MCO-170UVS (UV system set), MCO-50HP (H₂O₂ generator), MCO-50HB (H₂O₂ decon kit), and MCO-170EL (electric lock) are all installed on your incubator.

Notes:

- Before performing decontamination, read the precautions for safe operation on pages 5– 9.
- The door is locked by the electric lock during decontamination. However, if the key included with the electric lock has been inserted into the key hole and left in the position, the door cannot be locked. When performing decontamination, be sure to take the key out of the key hole and store and manage the key in a safe place.

H₂O₂ decontamination

1. Remove the trays, fan cover, duct, humidifying pan, gas injection nozzle, and gas injection nozzle tube from the chamber.
2. Pour off the water in the humidifying pan, and then wipe clean the removed inner attachments with alcohol for disinfection.
3. Wipe clean the chamber with alcohol for disinfection.
4. Attach the duct and fan cover.
5. Pour a bottle of MCO-5H2O2 H₂O₂ reagent (designated by our company) into the MCO-50HP H₂O₂ generator and then, cover it with the lid.

Note: H₂O₂ reagent cannot be stored after opening.

Notes: Follow the cautions below when using the optional MCO-5H2O2 (H₂O₂ reagent).

- Cautions in handling
 - Wear protective equipment such as protective glasses and rubber gloves when handling the H₂O₂ reagent.
 - Do not recklessly use fire in an area where H₂O₂ reagent is handled.
 - Do not leave H₂O₂ reagent in the container after or during use.
 - Do not place combustible or inflammable objects near areas where the H₂O₂ reagent is handled.
- Cautions in storage
 - Store the H₂O₂ reagent in a cool, dark place.
 - Always tighten the cap to the container to prevent contamination by adulterants.
 - Make sure the container is free of damage such as corrosion or cracking.
 - Store the containers with the mouth facing upwards, and make sure it cannot topple or fall.
- Cautions in disposal
 - Dilute the H₂O₂ reagent with a large volume of tap water for disposal.

6. Connect one end of the waterproof cable (included with the H₂O₂ generator) with the H₂O₂ generator and set the positioning fittings of the H₂O₂ generator into the slits of the duct (Fig. 1).

Ensure that the H₂O₂ generator is properly set. An improper setting may cause inadequate decontamination.

7. Remove the waterproof connector cap from the connector on the rear right of the chamber, and then connect the other end of waterproof cable to the connector (Fig. 2).

Note: Make sure not to lose the waterproof connector cap.

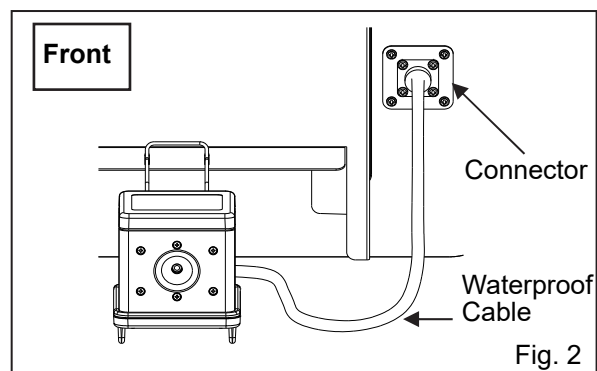
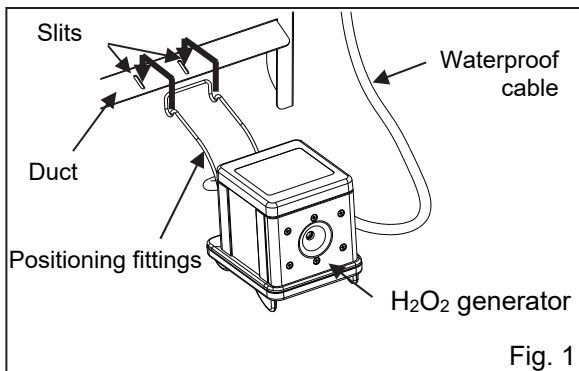

H₂O₂ DECONTAMINATION (OPTION)

8. Set the humidifying pan removed in step 1 by leaning it against the flange of the duct. Set the trays on the first and third tray catches from the top (Fig. 3).
Note: H₂O₂ decontamination function decontaminates the chamber and inner attachments. Do not place anything other than the designated inner attachments into the chamber during decontamination. Sterilize the gas injection nozzle, gas injection nozzle tube, and dedicated trays (option) removed in step 1 using method such as autoclave sterilization.

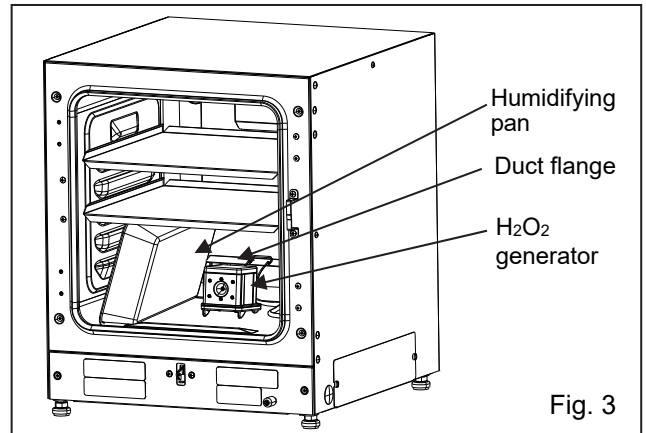

9. Make sure the duct, chamber fan, and H₂O₂ generator are attached correctly, and then close the inner door and outer door, referring Figures 1 - 3 on page 92.

10. Press and hold the H₂O₂ key (H₂O₂) while the Home screen is displayed.
 ▶ The display switches to the H₂O₂ Decontamination screen [Fig. 4]. Make sure the H₂O₂ reagent/H₂O₂ generator are properly set.

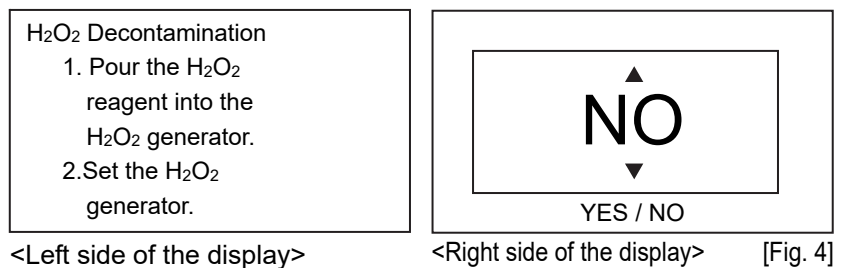

11. Press the up/down keys (△▽) to change the setting to YES.
 ◇The setting toggles between YES and NO each time the up/down keys are pressed.

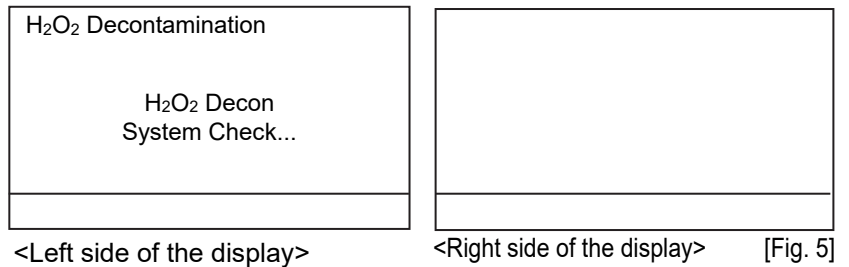

12. Press the Enter key (ENTER).
 ▶ The message indicating the system check execution is displayed on the left side of the display [Fig. 5] while the system check is performed.

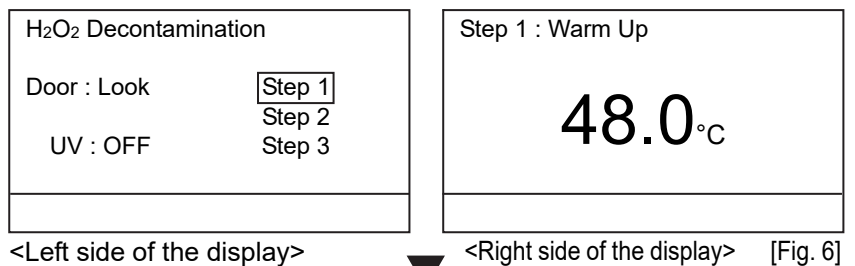

13. When the system check has completed successfully, H₂O₂ decontamination starts, and then Step 1 to Step 3 are sequentially displayed.

Step 1: Preparing for H₂O₂ decontamination [Fig. 6]
 In this process, the chamber is heated to 48 °C.

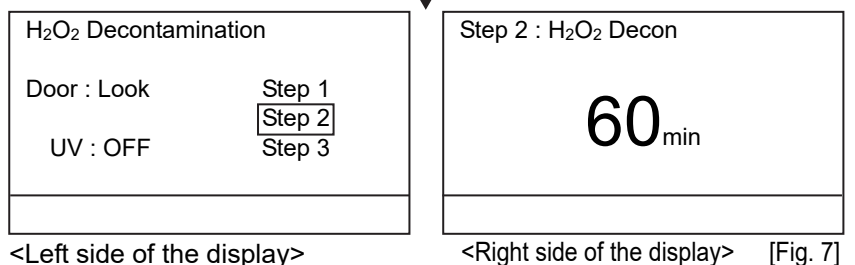

Step 2: H₂O₂ decontamination [Fig. 7]
 In this process, H₂O₂ vapor is generated from the H₂O₂ generator to decontaminate the chamber by H₂O₂.

Step 3: UV resolve [Fig. 8]
 This process breaks down the H₂O₂ vapor through UV irradiation.

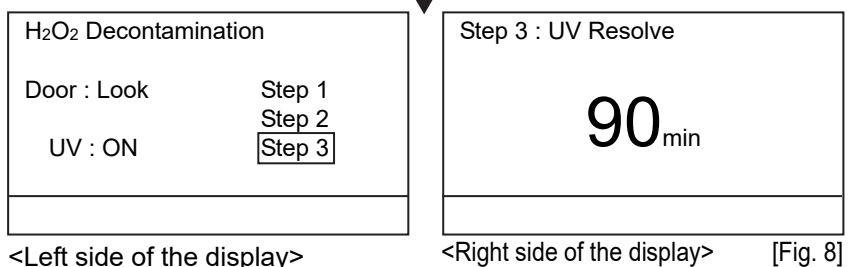

H₂O₂ DECONTAMINATION (OPTION)

*If an error occurs during the system check, the error screen is displayed [Fig. 9]. Check the error, and then stop the product and contact our sales representative or agent, unless the cause of the error is clear and recovery is expected.

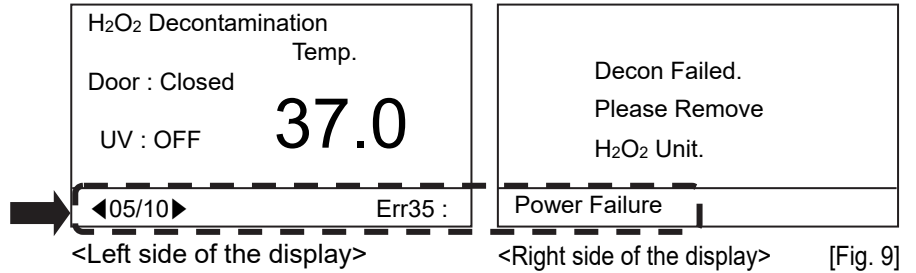

14. When H₂O₂ decontamination is complete, the Decon Finished message is displayed [Fig. 10]. Open the outer door and inner door, remove the power connector of the H₂O₂ generator from the connector of the main unit, and then remove the H₂O₂ generator. The right side of the display switches to the screen shown in Fig. 11.
Note: Always wear protective glasses and rubber gloves when performing this procedure.



15. Press the Enter key (ENTER).
▶ The Home screen is displayed.

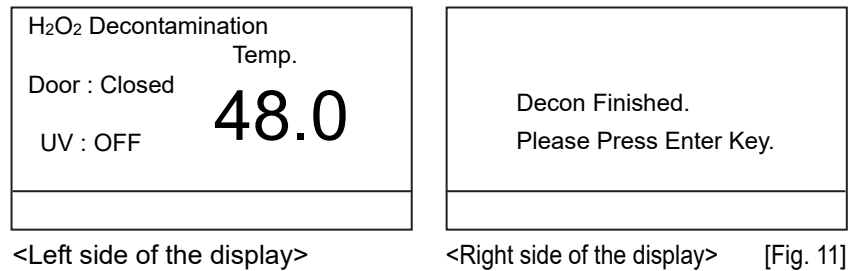

16. Dilute the remaining H₂O₂ reagent in the H₂O₂ generator with a large amount of water for disposal, and then rinse and wash the H₂O₂ generator with distilled water. Store the H₂O₂ generator outside of the incubator in a clean environment.
Note: Secure the waterproof connector cap firmly to the connector for the H₂O₂ generator to protect the connector part from getting wet [Fig. 12]. Do not clean inside and outside of the H₂O₂ generator with alcohol for disinfection.

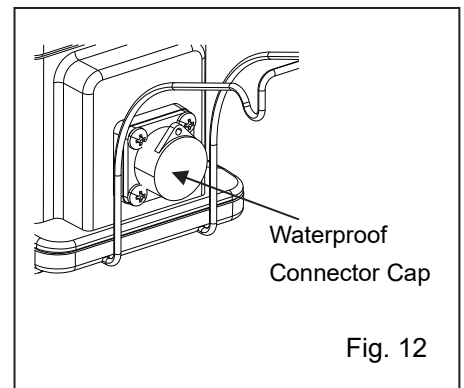

17. After the H₂O₂ decontamination work, the H₂O₂ liquid will remain in the bottom of the chamber and the lower part of the H₂O₂ generator. Therefore, wear protective glasses and rubber gloves and then, wipe clean these parts with a non-woven cloth.

18. Ventilate the chamber sufficiently, and then set the inner attachments back in their original positions in the chamber.

Notes:

- After the H₂O₂ decontamination work, secure the waterproof connector cap firmly to the connector of the incubator [Fig. 13].
- Make sure not to lose the lid of the H₂O₂ generator.

Caution: Wait at least one hour before starting the cultivation until the culture environment is stable.

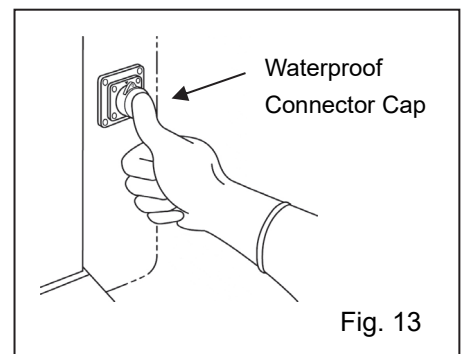

H₂O₂ DECONTAMINATION (OPTION)

*If the H₂O₂ decontamination is terminated or ends in error, the error number, error code, and error message is displayed after H₂O₂ decontamination [Fig. 14].
 ✧ You can see the error information by pressing the left/right keys.

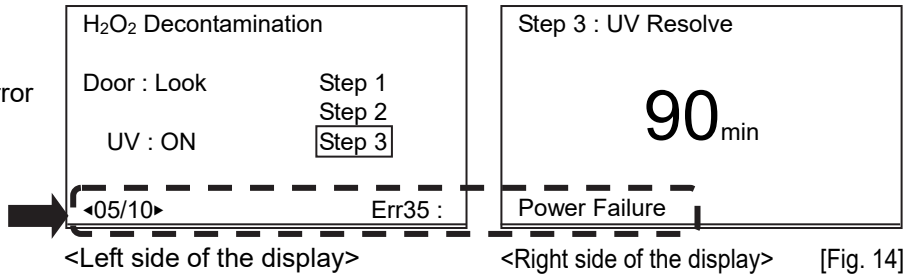

*If the Cancel key (CANCEL) is pressed to stop the decontamination process during Step 1 or Step 2, a confirmation screen is displayed on the right side of the display [Fig. 15]. Change the setting to YES using the up/down keys (△▽), and then press the Enter key (ENTER).

Caution: H₂O₂ decontamination cannot be stopped during Step 3 (UV resolve).

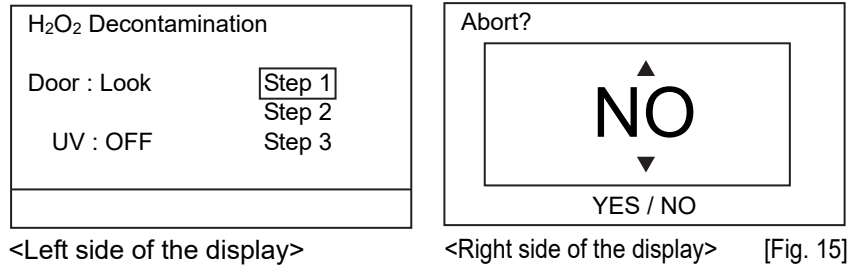

If decontamination is canceled during Step 1, the screen in Fig. 16 is displayed. Open the outer door and inner door, remove the power connector of the H₂O₂ generator from the connector of the main unit, and then remove the H₂O₂ generator to complete the decontamination work.

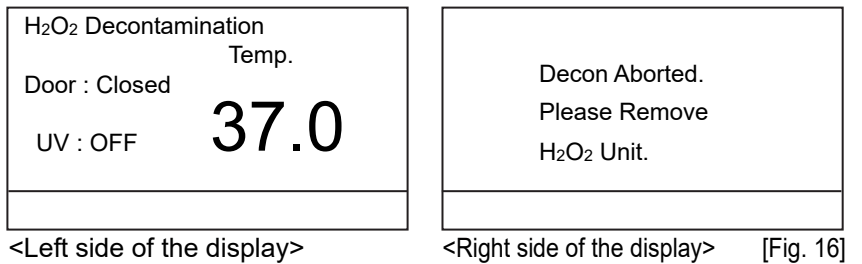

If decontamination is canceled during Step 2, the screen in Fig. 17 is displayed, Step 3: UV resolve starts, and then the screen in Fig. 18 is displayed after the H₂O₂ vapor has been broken down. Open the outer door and inner door, remove the power connector of the H₂O₂ generator from the connector of the main unit, and then remove the H₂O₂ generator to complete the decontamination work.

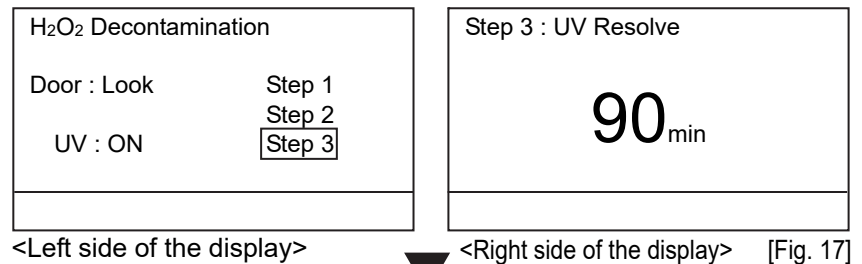

ALARMS, SAFETY, AND SELF-DIAGNOSIS

This product has the following warning, safety, and self diagnosis functions.

When the alarm function or the self-diagnosis function activates, an error code and error message will be displayed on the display.

Error: Performance for culture and decontamination has decreased sharply. Stop the product and contact our sales representative or agent unless you know the cause of the error and you can expect the recovery.

Error codes during normal operation

OLED Display		Alarm type	Buzzer	Remote alarm	Safety operation
Error code	Message				
Err 01: CO ₂ Gas Empty	The CO ₂ density does not increase when the CO ₂ valve is opened.	CO ₂ gas cylinder empty	Intermittent tone	ON	----
Err 02: N ₂ /O ₂ Gas Empty	The O ₂ density does not change when the N ₂ /O ₂ valve is opened.	N ₂ /O ₂ gas cylinder empty			
Err 03: CO ₂ Connect Error	The CO ₂ density keeps increasing when the CO ₂ valve is closed.	Connection mistake of CO ₂ line and N ₂ /O ₂ line			The CO ₂ valve and the N ₂ /O ₂ valve are closed.
Err 04: N ₂ /O ₂ Connect Error	The O ₂ density keeps changing into the opposite direction when the N ₂ /O ₂ valve is opened.	Selection mistake of N ₂ gas and O ₂ gas.			
Err 05: Temp Sensor Open	The chamber temperature sensor is disconnected.	Chamber temperature sensor error			Heater OFF
Err 06: Temp Sensor Short	The chamber temperature sensor is short-circuited.				
Err 07: CO ₂ Box Sensor Open	The sensor box temperature sensor is disconnected.	Sensor box temperature sensor error			The CO ₂ valve and the N ₂ /O ₂ valve are closed.
Err 08: CO ₂ Box Sensor Short	The sensor box temperature sensor is short-circuited.				
Err 09: AT Sensor Open	The ambient temperature sensor is disconnected.	Ambient temperature sensor error			----
Err 10: AT Sensor Short	The ambient temperature sensor is short-circuited.				
Err 11: CO ₂ Sensor Vref Error	The Vref output voltage for the CO ₂ sensor is abnormal.	CO ₂ sensor error			CO ₂ valve is closed.
Err 12: CO ₂ Sensor Vgas Error	The Vgas output voltage for the CO ₂ sensor is abnormal.				

ALARMS, SAFETY, AND SELF-DIAGNOSIS

OLED Display		Alarm type	Buzzer	Remote alarm	Safety operation	
Error code	Message					
Err 13: Main Heater Error	Main heater burnout occurs or the main heater SSR is short-circuited.	Main heater error	Intermittent tone	ON	-----	
Err 14: Humidity Heater Error	Bottom heater burnout occurs or the bottom heater SSR is short-circuited.	Bottom heater error				
Err 15: Door Heater Error	Door heater burnout occurs or the door heater SSR is short-circuited.	Door heater error				
Err 16: CO ₂ Box Heater Error	Overheat alarm is activated, or the sensor box heater burnout occurs or the sensor box heater SSR is short-circuited.	Sensor box heater error				
Err 17: Heater SSR Open	Overheat alarm is activated, or any heater SSR burnout occurs.	SSR disconnection for heater				
Err 18: UV Lamp Abnormal* ¹	The UV lamp is burnt out.	UV lamp failure			N ₂ /O ₂ valve is closed.	
Err 19: O ₂ Sensor Abnormal	The measured voltage for the O ₂ sensor is abnormal.	O ₂ sensor error				
Err 20: Door Lock Failure* ²	The outer door is open during autolocked by electric lock.	Door lock error				UV lamp OFF
Err 39: Fan Motor Error	Rotational speed of fan motor is abnormal.	Fan motor failure			The CO ₂ valve and the N ₂ /O ₂ valve are closed.	
Err 56: Communication Failure	Communication between display and control is unstable.	Communication error			-----	-----
Err 65: Peltier Fan Error	Rotational speed of peltier fan motor is abnormal.	Peltier fan motor error	Intermittent tone	ON		

*1: When the optional UV system set MCO-170UVS is installed.

*2: When the optional electric lock MCO-170EL is installed.

ALARMS, SAFETY, AND SELF-DIAGNOSIS

Error codes during H₂O₂ decontamination*1

OLED Display		Alarm type	Buzzer	Remote alarm	Safety operation
Error code	Message				
Err 31:H ₂ O ₂ Unit Not Found	The H ₂ O ₂ generator is not connected.	System check error at start of H ₂ O ₂ decontamination.	-----	-----	H ₂ O ₂ decontamination is cancelled.
Err 32:Low H ₂ O ₂ Level	There is no H ₂ O ₂ solution or the H ₂ O ₂ level sensor has failed (or is disconnected).				
Err 33:Outer Door Open	The door is not closed.				
Err 34:H ₂ O ₂ Volume Error	The volume of H ₂ O ₂ generated is abnormal.	Failure during H ₂ O ₂ decontamination.	Intermittent tone	ON	Moves to UV resolve.
Err 35:Power Failure	Power was interrupted during H ₂ O ₂ decon cycle.				<ul style="list-style-type: none"> · During power failure, outer door is locked by electric lock. · H₂O₂ decontamination is cancelled (if the cancellation is after H₂O₂ spray, it is stopped after decontamination process is performed.)
Err 36:UV Lamp Failure	UV lamp failed during H ₂ O ₂ decon cycle.				Failure during H ₂ O ₂ gas resolve by UV.
Err 38:Door Lock Failure	The outer door is open during H ₂ O ₂ decon cycle	When the outer door is open during H ₂ O ₂ decontamination.	Continuous tone (when the outer door is open.)	ON (when the outer door is open.)	*2

*1: When the optional UV system set MCO-170UVS, H₂O₂ generator MCO-50HP, H₂O₂ decon kit MCO-50HB and electric lock MCO-170EL are all installed.

*2: Each safety operation for Err38

Failure during warming-up	H ₂ O ₂ decontamination is cancelled.
Failure during H ₂ O ₂ decontamination	Cancel generation of H ₂ O ₂ mist and move to UV resolve. Resolve time is extended.
Failure during H ₂ O ₂ gas resolve by UV	Resolve time is extended.

ALARMS, SAFETY, AND SELF-DIAGNOSIS

Warning: Performance for culture may decrease. If it is a temporary situation due to operations, wait for recovery. Otherwise, contact our sales representative or agent.

OLED Display		Alarm type	Buzzer	Remote alarm	Safety operation
Warning	Message				
Warning: Over Heat	The chamber's Temperature exceeds the high limit alarm temperature set value.	High limit temperature alarm* ¹	Continuous tone	ON	Heater OFF.
Warning: High Temp or Warning: Low Temp	The chamber's Temperature is out of the automatic setting range ($\pm 1.0\text{ }^{\circ}\text{C}$ to $\pm 5.0\text{ }^{\circ}\text{C}$).	Temperature alarm* ²	Intermittent tone after set time of alarm delay has elapsed	ON after set time of alarm delay has elapsed	----
Warning: High CO ₂ Density or Warning: Low CO ₂ Density	The chamber's CO ₂ density is out of the automatic setting range ($\pm 0.5\%$ to $\pm 5.0\%$).	CO ₂ density alarm* ²			
Warning: High O ₂ Density or Warning: Low O ₂ Density	The chamber's O ₂ density is out of the automatic setting range ($\pm 0.5\%$ to $\pm 5.0\%$).	O ₂ density alarm* ²			
Warning: UV Bulb Life	The accumulated ON time has reached approx. 5,000h.	New UV lamp replacement	----	----	----
Warning: USB Over Current	The USB output current is abnormal (over 0.5A, or Short-circuit to 0V).	USB overcurrent alarm	----	----	----

*1: Err 16 (Sensor Box Heater Error) and Err17 (SSR disconnection for heater) are generated when a certain period of time has elapsed after the high-limit temperature alarm activated.

*2: When the fan motor speed is lowered due to malfunction or the end of its life, these alarms may activate because of uneven temperature distribution or CO₂/O₂ density in the chamber.

Status: The status of the equipment is notified. Check the situation and take appropriate measures.

OLED Display		Alarm type	Buzzer	Remote alarm	Safety operation
Status information	Message				
Preparing Gas Control	----	Waiting for the temperature to be stable and the gas to be controllable after the power switch has been turned ON.	----	----	----
"Door:Open" is displayed in reverse video.	----	The outer door is open.	Intermittent tone after set time of door alarm delay (1 min to 30 min) has elapsed	----	The CO ₂ valve and the N ₂ /O ₂ valve are closed. The heater turns OFF after 1 min.
"A" or "B" of the CO ₂ gas supply line indicator blinks.	----	CO ₂ cylinder is empty	----	----	----

ALARMS, SAFETY, AND SELF-DIAGNOSIS

- Tables 6–8 show the behaviour of the alarm (buzzer) and ring back function when pressing the BUZZER STOP key.

Table 6. In cases other than those covered in Tables 7 and 8

Remote Alarm setting	Ring Back setting	Buzzer from CO ₂ incubator		Remote Alarm	
		When pressing the BUZZER STOP key	When the Ring Back set time passes	When pressing the BUZZER STOP key	When the Ring Back set time passes
ON: Remote alarm setting not linked with BUZZER STOP key	ON	OFF (Alarm is not cancelled)	ON	ON	ON (Under continuation)
	OFF		OFF		
OFF: Remote alarm setting linked with BUZZER STOP key	ON	OFF (Alarm is not cancelled)	ON	OFF (Alarm is not cancelled)	ON
	OFF		OFF		OFF

Note: Resolve the cause of the alarm, as the alarm itself is not deactivated by pressing the BUZZER STOP key.

Table 7. In the case of high limit temperature alarm or Err38

Remote Alarm setting	Ring Back setting	Buzzer from CO ₂ incubator		Remote Alarm	
		When pressing the BUZZER STOP key	When the Ring Back set time passes	When pressing the BUZZER STOP key	When the Ring Back set time passes
ON: Remote alarm setting not linked with BUZZER STOP key	ON	ON	ON (Under continuation)	ON (Continue)	ON (Under continuation)
	OFF				
OFF: Remote alarm setting linked with BUZZER STOP key	ON	ON	ON (Under continuation)	ON (Continue)	ON (Under continuation)
	OFF				

Note: Close the outer door when Err38 is activated.

Table 8. In cases of Err01, Err02, Err11, Err12, Err18, or door alarm*¹

Remote Alarm setting	Ring Back setting	Buzzer from CO ₂ incubator		Remote Alarm	
		When pressing the BUZZER STOP key	When the Ring Back set time passes	When pressing the BUZZER STOP key	When the Ring Back set time passes
ON: Remote alarm setting not linked with BUZZER STOP key	ON	OFF (Alarm is cancelled)	OFF (Alarm is already cancelled)	OFF (Alarm is cancelled* ¹)	OFF (Alarm is already cancelled* ¹)
	OFF				
OFF: Remote alarm setting linked with BUZZER STOP key	ON	OFF (Alarm is cancelled)	OFF (Alarm is already cancelled)	OFF (Alarm is cancelled* ¹)	OFF (Alarm is already cancelled* ¹)
	OFF				

*¹: The remote alarm does not work for the door alarm.

Note: When Err01 is activated, connect the new CO₂ gas cylinder and press the BUZZER STOP key to stop the buzzer. In addition, when the optional MCO-50GC is installed and the gas supply is switched to the reserve gas cylinder, press the BUZZER STOP key and replace the gas cylinder.

ROUTINE MAINTENANCE

To use this unit in a clean condition, clean the chamber and all the inner attachments at least once a month.

1. Remove all the inner attachments by the procedures shown on pages 23 and 24.
2. Clean the chamber and all the inner attachments by the procedures shown on page 22.
3. Install all the inner attachments by the procedures shown on page 25.

- When there is excessive dirt, contact our sales representative or agent.

TROUBLESHOOTING

If the incubator does not seem to be working properly, check the following items before calling for service.

Problem	Items to be checked and countermeasures
The incubator does not operate at all.	<ul style="list-style-type: none"> • Is the incubator plugged in? • Is there a power outage, or has a circuit breaker interrupted the power? • Is the removable power supply cord connected to the port on the lower right side of the cabinet?
An alarm is activated.	<p>[When starting operation]</p> <ul style="list-style-type: none"> • Does the chamber temperature match the set value? • Does the CO₂/O₂ gas density in the chamber match the set value? <ol style="list-style-type: none"> (1) Is the secondary pressure for the gas regulator of CO₂ gas cylinder at the specified value of 0.03 MPa(G) –0.1 MPa(G) (0.3 kgf/cm²(G) –1 kgf/cm²(G), 4.4 psi(G) –14.5 psi(G))? (2) Is the secondary pressure for the gas regulator of N₂ gas (O₂ gas) cylinder at the specified value of 0.05 MPa(G) –0.1 MPa(G) (0.5 kgf/cm²(G) –1 kgf/cm²(G), 7.3 psi(G) –14.5 psi(G))? (3) Is the gas tube properly connected? <p>[During operation]</p> <ul style="list-style-type: none"> • Has the high-limit alarm temperature been set at least 1 °C higher than the temperature set for the chamber? • Has the temperature setting been changed? Has the outer door been left open for a long time? Has a low-temperature object been placed in the chamber? If any of these is the case, the alarm will clear automatically after a short time. • Has the gas tube come loose, or is there a gas leak? • Has the CO₂/O₂ gas density setting been changed? • Is the gas cylinder empty? Check the primary pressure of the gas cylinder once a week (A primary pressure reading of 3.8 MPa(G) (38 kgf/cm²(G), 551 psi(G)) or lower is a sign that there is little gas remaining. Replace the cylinder soon). • Is the incubator operating beside an appliance that generates electromagnetic waves?
The chamber temperature does not match the set value.	<ul style="list-style-type: none"> • Is the ambient temperature at least 5 °C lower than the temperature set for the chamber? • Is the outer door closed with the inner door left open? • Is the incubator operating beside an appliance that generates electromagnetic waves?
The chamber humidity does not rise.	<ul style="list-style-type: none"> • Is there enough water in the humidifying pan (be sure to use sterile distilled water)?
The gas density does not match the set value.	<ul style="list-style-type: none"> • Is the secondary pressure for the gas regulator of CO₂ gas cylinder at the specified value of 0.03 MPa(G) –0.1 MPa(G) (0.3 kgf/cm²(G) –1 kgf/cm²(G), 4.4 psi(G) –14.5 psi(G))? • Is the secondary pressure for the gas regulator of N₂ gas (O₂ gas) cylinder at the specified value of 0.05 MPa(G) –0.1 MPa(G) (0.5 kgf/cm²(G) –1 kgf/cm²(G), 7.3 psi(G) –14.5 psi(G))? • Is the gas tube blocked? • Is the duct securely attached? (See page 92) • Is the fan attached properly? (See page 92) • Is the incubator operating beside an appliance that generates electromagnetic waves?
A large quantity of gas is being consumed.	<ul style="list-style-type: none"> • Are the outer and inner doors being frequently opened and closed? • Check whether gas is leaking from connectors due to deterioration of the gas tube, or whether there may be any pinhole leaks. The gas tube is a consumable part, and it is recommended to replace the tube once a year. • Is the packing seal for the inner door defective? • Is the access hole open?
Cannot culture properly and the gas density in the chamber may be the cause.	<ul style="list-style-type: none"> • Is the air environment around the incubator normal? Is there a source of polluted gas in the vicinity?

TROUBLESHOOTING

Problem	Items to be checked and countermeasures
Gas is not being injected.	<ul style="list-style-type: none"> • This incubator adopts ON-OFF method for controlling CO₂/O₂. Gas is intermittently injected as the gas density in the chamber approaches the set value. Injections may stop for approximately 15 seconds, but that is not an error. • The gas is not injected until the temperature of the CO₂ sensor becomes sufficiently stable (approximately 1 hour after turning ON the power switch or recovering from power failure).
The gas density is slow to recover.	<ul style="list-style-type: none"> • A HEPA filter is used for the incubator gas piping. If gas density is slow to recover when the gas pressure is normal, it is possible that the HEPA filter may be clogged. Contact our sales representative or agent. • Is there little gas remaining in the gas cylinder? • Is the secondary pressure for the gas regulator of CO₂ gas cylinder at the specified value of 0.03 MPa(G) –0.1 MPa(G) (0.3 kgf/cm²(G) –1 kgf/cm²(G), 4.4 psi(G) –14.5 psi(G))? • Is the secondary pressure for the gas regulator of N₂ gas (O₂ gas) cylinder at the specified value of 0.05 MPa(G) –0.1 MPa(G) (0.5 kgf/cm²(G) –1 kgf/cm²(G), 7.3 psi(G) – 14.5 psi(G))? • Is the gas tube blocked? • Is the duct securely attached? (Fig. 1) • Is the fan attached properly? (Fig. 2)
The outer door does not open.	<p>(When the optional MCO-170EL is installed)</p> <ul style="list-style-type: none"> • When the power switch is OFF, the electric lock is locked and the outer door does not open. Either turn ON the power switch or use the accessory unlock key to override the electric lock. • During decontamination, the outer door is electrically locked and does not open.
Cannot start H ₂ O ₂ decontamination (Cannot select "YES" in Fig.4 on page 83).	<ul style="list-style-type: none"> • Contact our sales representative or agent when you cannot start H₂O₂ decontamination even if the H₂O₂ decon kit MCO-50HB is installed.
H ₂ O ₂ decontamination error is generated.	<ul style="list-style-type: none"> • Are optional MCO-170UVS, MCO-50HP, MCO-50HB and MCO-170EL installed? • Has the UV lamp burned out? If the UV lamp has burned out, you cannot perform H₂O₂ decontamination. • Is the H₂O₂ generator cable properly connected? • Has a bottle of MCO-5H2O2 H₂O₂ reagent been poured?
In H ₂ O ₂ decontamination cycle, "Err34: H ₂ O ₂ Volume Error" is activated.	<ul style="list-style-type: none"> • Is the duct securely attached? Attach the duct properly to the 4 pins (Fig. 1). • Is the fan attached properly? Check if the fan hole securely fits with the motor shaft (Fig. 2). • Is the H₂O₂ generator securely installed? Set the positioning fittings of the H₂O₂ generator into the slits of the duct (Fig. 3). • Is it the end-of-life of the H₂O₂ generator? Replace the H₂O₂ generator after approximately 1,100 uses.

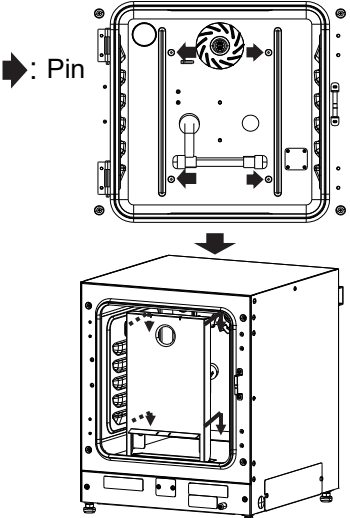

Fig.1

1. Position the center hole of the fan over the projection of the motor shaft and push it fully in.

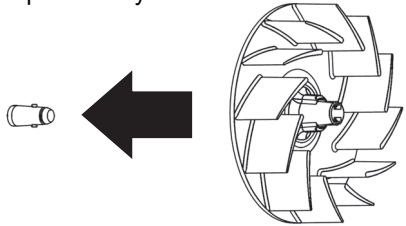

Fig.2

2. Manually turn the fan lightly to check that it does not touch the rear wall.
3. Pull the fan lightly to check that it does not come off.

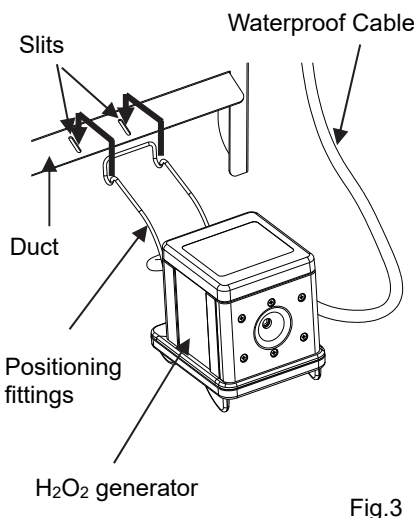

Fig.3

Note: If the problem still has not been solved after trying the above checks and countermeasures, or for any problems not covered here, contact our sales representative or agent.
 Keep an electric product which emits an electromagnetic wave away from this product. A noise from an electromagnetic wave may cause this product to malfunction.

DISPOSAL OF UNIT

Before disposal of this O₂/CO₂ incubator, contact our sales representative or agent for further information. Improper handling of biohazardous waste can result in accidental exposure to infectious agents. If there is a danger of biohazard, decontaminate the incubator as thoroughly as possible before disposal.



- Label indication is obliged to comply with Taiwanese battery regulation.

SPECIFICATIONS

Product name	O ₂ /CO ₂ Incubator MCO-50M
External dimensions	W 480 mm x D 550 mm x H 585 mm (W 18.9 in. x D 21.7 in. x H 23.0 in.)
Internal dimensions	W 370 mm x D 363 mm x H 385 mm (W 14.6 in. x D 14.3 in. x H 15.2 in.)
Interior volume	50 L (1.77 cu.ft.)
Exterior	Painted steel (Back cover has no paint)
Interior	Stainless steel containing copper
Outer door	Painted steel
Inner door	Tempered glass
Trays	2 trays made of stainless steel containing copper W 353 mm x D 308 mm x H 12 mm (W 13.9 in. x D 12.1 in. x H 0.47 in.) Maximum load: 7 kg (15 lbs.)/tray
Access port	Inner diameter: 30 mm (1.18 in.); on the back side
Insulation	Styrene AcryloNitrile copolymer
Heating system	DHA system (heater jacket + air jacket system)
Heater	165 W
Humidifying system	Natural evaporation with humidifying pan
Temperature controller	PID control system
Temperature display	Digital display
CO ₂ controller	PID control system
CO ₂ density display	Digital display
O ₂ controller	PID control system
O ₂ density display	Digital display
Air circulation	Fan-assisted
Gas line filter	0.01 µm, Efficiency: 99.99 % or higher
Alarms	Temperature alarm, CO ₂ density alarm, O ₂ density alarm, High-limit temperature alarm, CO ₂ /O ₂ /N ₂ gas alarm, heater alarm, fan stop alarm
Remote alarm contacts	Allowable contact capacity: DC 30 V, 2 A ^{*1}
CO ₂ inlet connection	Soft Polyurethane tube can be connected. (ID 4 mm, OD 6 mm (ID 0.157 in. ,OD 0.236 in.))
CO ₂ inlet pressure	0.03 MPa(G)–0.1 MPa(G) (0.3 kgf/cm ² (G)–1 kgf/cm ² (G), 4.4 psi(G)–14.5 psi(G))
O ₂ inlet connection	Soft Polyurethane tube can be connected. (ID 4 mm, OD 6 mm (ID 0.157 in. ,OD 0.236 in.))
O ₂ inlet pressure	0.05 MPa(G)–0.1 MPa(G) (0.5 kgf/cm ² (G)–1 kgf/cm ² (G), 4.4 psi(G)–14.5 psi(G))
Weight	46 kg (101 lbs.)
Accessories	1 removable power supply cord, 1 power supply cord cover plate, 2 trays, 3 gas tubes, 1 humidifying pan, 1 Gas injection nozzle, 1 Gas injection nozzle tube, 3 conversion joints

*1: It is recommended to use standard signal and interface cables with a maximum length of 30 meters.

SPECIFICATIONS

Table 9. Optional accessories

For UV disinfection	UV system set (MCO-170UVS)
For H ₂ O ₂ decontamination	UV system set (MCO-170UVS) Electric lock (MCO-170EL) H ₂ O ₂ generator (MCO-50HP) H ₂ O ₂ decon kit (MCO-50HB) H ₂ O ₂ reagent (MCO-5H2O2)
For locking the outer door	Electric lock (MCO-170EL)
Other options	Double-stacking bracket (MCO-170PS) *1 Stacking plate (MCO-50SB) *1 Roller base (MCO-50RB) Gas regulator (MCO-010R) Gas auto changer (MCO-50GC) Tray (MCO-50ST: same as that of standard accessory) Interface board (MCO-420MA) Interface board (MTR-L03) *2, *3; for LAN Interface board (MTR-480) *2; for RS-232C/RS-485

*1: Refer to Table 10,11.

*2: • Only for the Data acquisition system MTR-5000 user.

• It is recommended to use standard signal and interface cables with a maximum length of 30 meters.

*3: Use an STP cable for the LAN cable.

Notes:

- Refer to the updated catalogue when ordering an optional component.
- Designs and specifications are subject to change without notice.

Table 10. Bracket/plate required for each combination of double-stacking incubators

(Any other configurations are not recommended.)

		Upper product	
		MCO-50AIC/M	MCO-5AC/M
Lower product	MCO-50AIC/M	Double-stacking bracket MCO-170PS	—
	MCO-5AC/M	Stacking plate MCO-50SB	2 pair of stacking plates included with MCO-5AC / M

Table 11. Bracket/plate required for each combination of triple-stacking incubators

(Any other configurations are not recommended.)

Upper product	MCO-50AIC/M		
	Stacking plate MCO-50SB	Double-stacking bracket MCO-170PS	
Middle product	MCO-5AC/M	MCO-50AIC/M	
	2 pair of stacking plates included with MCO-5AC / M	Stacking plate MCO-50SB	Double-stacking bracket MCO-170PS
Lower product	MCO-5AC/M		MCO-50AIC/M

PERFORMANCE

Product name	O ₂ /CO ₂ Incubator MCO-50M
Model number	MCO-50M-PA
Temperature control range	Ambient temperature plus 5 °C to max. 50 °C*1 (ambient temperature: 5 °C to 35 °C)
Temperature distribution	±0.25 °C (ambient temperature: 23 °C, setting: 37 °C, CO ₂ : 5 %, O ₂ : 5 %, no load)
Temperature variation	±0.1 °C (ambient temperature: 23 °C, setting: 37 °C, CO ₂ : 5 %, O ₂ : 5 %, no load)
CO ₂ setting range	0 % to 20 %
CO ₂ variation	±0.15 % (ambient temperature: 23 °C, setting: 37 °C, CO ₂ : 5 %, O ₂ : 5 %, no load)
O ₂ setting range	1 % to 18 % and 22 % to 80 %
O ₂ variation	±0.2 % (ambient temperature: 23 °C, setting: 37 °C, CO ₂ : 5 %, O ₂ : 5 %, no load)
Chamber humidity	95 %R.H.±5 %R.H.
Applicable environmental condition	Temperature: 5 °C to 35 °C, Humidity: 80 %R.H. max. (The optimum performance may not be obtained if the ambient temperature is not above 15 °C)
Noise level	29 dB (A scale)
Power consumption	Max. 210 W
Heat emission	Max. 650 kJ/h
Rated voltage, frequency	AC 110 V–120 V, 60 Hz
Amperage	Max. 1.9 A

*1: When set temperature is 37 °C, ambient temperature must be 32 °C or less. Regardless of ambient temperature, the maximum value of the temperature control range is always 50 °C.

Notes:

- Based on our measuring method.
- Default calibration conditions: 37 °C, CO₂: 5 %, O₂: 5 %

When using under other conditions, we recommend calibration under the conditions of use.

- We recommend calibration every year.

SAFETY CHECK SHEET



CAUTION

Please fill in this form before servicing.
Hand over this form to the service engineer for their and your safety.

Safety check sheet

1. Unit contents:

- Risk of infection: Yes No
Risk of toxicity: Yes No
Risk from radioactive sources: Yes No

(List all potentially hazardous materials that have been stored in this unit.)

Notes:

2. Contamination of the unit

Unit interior

- No contamination Yes No
Decontaminated Yes No
Contaminated Yes No

Others:

3. Instructions for safe repair/maintenance/disposal of the unit

- a) The unit is safe to work on Yes No
b) There is some danger (see below) Yes No

Procedure to be adhered to in order to reduce safety risk indicated in b) below.

Date:

Signature:

Address, Division:

Telephone:

Product name:

O₂/CO₂ incubator

Model No.

MCO-

Serial number:

Date of Installation:

Please decontaminate the unit yourself before calling the service engineer.

MEMO

MEMO

PHC Corporation

1-1-1 Sakada, Oizumi-machi, Ora-gun, Gunma 370-0596, Japan

© PHC Corporation 2019



Printed in Indonesia
LDCL064500-2
N0919-20720