

PHCbi

Operating Instructions

Biomedical Freezer

MDF-U731



Please read the operating instructions carefully before using this product, and keep the operating instructions for future use.

See page 23 for model number.

CONTENTS

INTRODUCTION	P. 2
PRECAUTIONS FOR SAFE OPERATION	P. 3
ENVIRONMENTAL CONDITIONS	P. 7
SYMBOLS ON UNIT	P. 7
FREEZER COMPONENTS	P. 8
Freezer unit	P. 8
Control panel	P. 10
INSTALLATION SITE	P. 11
INSTALLATION	P. 12
START-UP OF UNIT	P. 12
TEMPERATURE SETTING	P. 13
KEY LOCK FUNCTION	P. 13
REMOTE ALARM TERMINAL	P. 14
ALARM FUNCTIONS	P. 15
SAFETY FUNCTIONS	P. 15
SELF DIAGNOSTIC FUNCTIONS	P. 16
MAINTENANCE	P. 17
Cleaning of cabinet	P. 17
Cleaning of evaporating tray	P. 17
Defrosting	P. 18
TROUBLESHOOTING	P. 19
DISPOSAL OF UNIT	P. 20
Recycle of battery	P. 20
Decontamination of unit	P. 20
REPLACEMENT OF WEAR-OUT PARTS	P. 21
Replacement of battery for power failure alarm	P. 21
TEMPERATURE RECORDER (OPTION)	P. 21
SPECIFICATIONS	P. 22
PERFORMANCE	P. 23
SAFETY CHECK SHEET	P. 24

INTRODUCTION

- Read the operating instructions carefully before using the appliance and follow the instructions for safety operation.
- PHC Corporation never guarantees any safety if the appliance is used for any objects other than intended use or used by any procedures other than those mentioned in the operating instructions.
- Keep the operating instructions in an adequate place to refer to it as necessary.
- The contents of the operating instructions will be subjected to change without notice due to the improvement of performance or functions.
- Contact our sales representative or agent if any page of the operating instructions is lost or page order is incorrect.
- Contact our sales representative or agent if any point in the operating instructions is unclear or if there are any inaccuracies.
- No part of this operating instructions may be reproduced in any form without the expressed written permission of PHC Corporation.

IMPORTANT NOTICE

PHC Corporation guarantees this product under certain warranty conditions. However, please note that PHC Corporation shall not be responsible for any loss or damage to the contents of the product.

PRECAUTIONS FOR SAFE OPERATION

It is imperative that the user complies with the operating instructions as it contains important safety advice.

Items and procedures are described so that you can use this unit correctly and safely. If the precautions advised are followed, this will prevent possible injury to the user and any other person.

Precautions are illustrated in the following way:



WARNING

Failure to observe WARNING signs could result in a hazard to personnel possibly resulting in serious injury or death.

CAUTION

Failure to observe CAUTION signs could result in injury to personnel and damage to the unit and associated property.

Symbol shows;

-  This symbol means caution.
-  This symbol means an action is prohibited.
-  This symbol means an instruction must be followed.















Be sure to keep the operating instructions in a place accessible to users of this unit.

For the State of California, USA Only:

This product contains a CR Coin Cell Lithium Battery which contains Perchlorate Material – special handling may apply. See www.dtsc.ca.gov/hazardouswaste/perchlorate.













PRECAUTIONS FOR SAFE OPERATION

WARNING

-  **Do not use the unit outdoors.** Current leakage or electric shock may result if the unit is exposed to rain water.
-  **Only qualified engineers or service personnel should install the unit.** The installation by unqualified personnel may cause electric shock or fire.
-  **Install the unit on a sturdy floor and take an adequate precaution to prevent the unit from turning over.** If the floor is not strong enough or the installation site is not adequate, this may result in injury from the unit falling or tipping over.
-  **Never install the unit in a humid place or a place where it is likely to be splashed by water.** Deterioration of the insulation may result which could cause current leakage or electric shock.
-  **Never install the unit in a flammable or volatile location.** This may cause explosion or fire.
-  **Never install the unit where acid or corrosive gases are present** as current leakage or electric shock may result due to corrosion.
-  **Always ground (earth) the unit to prevent electric shock.** If the power supply outlet is not grounded, it will be necessary to install a ground by qualified engineers.
-  **Never ground the unit through a gas pipe, water main, telephone line or lightning rod.** Such grounding may cause electric shock in the case of an incomplete circuit.
-  **Connect the unit to a power source as indicated on the rating label attached to the unit.** Use of any other voltage or frequency other than that on the rating label may cause fire or electric shock.
-  **Never store volatile or flammable substances** in this unit if the container cannot be sealed. These may cause explosion or fire.
-  **Do not insert metal objects such as a pin or a wire into any vent, gap or any outlet on the unit.** This may cause electric shock or injury by accidental contact with moving parts.
-  **Use this unit in safe area when treating the poison, harmful or radiate articles.** Improper use may cause bad effect on your health or environment.
-  **Turn off the power switch (if provided) and disconnect the power supply to the unit prior to any repair or maintenance** of the unit in order to prevent electric shock or injury.
-  **Do not touch any electrical parts (such as power supply plug) or operate switches with a wet hand.** This may cause electric shock.









PRECAUTIONS FOR SAFE OPERATION

WARNING

-  **Ensure you do not inhale or consume medication or aerosols** from around the unit at the time of maintenance. These may be harmful to your health.
-  **Never splash water directly onto the unit** as this may cause electric shock or short circuit.
-  **Never put containers with liquid on the unit** as this may cause electric shock or short circuit when the liquid is spilled.
-  **Never bind, process, or step on the power supply cord, or never damage or break the power supply plug.** A broken supply cord or plug may cause fire or electric shock.
-  **Do not use the power supply cord if its plug is loose.** Such power supply cord may cause fire or electric shock.
-  **Never disassemble, repair, or modify the unit yourself.** Any such work carried out by an unauthorized person may result in fire, or electric shock or injury due to a malfunction.
-  **Disconnect the power supply plug if there is something wrong with the unit.** Continued abnormal operation may cause electric shock or fire.
-  **When removing the power supply plug from the power supply outlet, grip the power supply plug,** not the cord. Pulling the cord may result in electric shock or fire by short circuit.
-  **Disconnect the power supply plug** before moving the unit. Take care not to damage the power supply cord. A damaged cord may cause electric shock or fire.
-  **Disconnect the power supply plug when the unit is not used for long periods.** Keeping the connection may cause electric shock, current leakage, or fire due to the deterioration of insulation.
-  **If the unit is to be stored unused in an unsupervised area for an extended period, ensure that children do not have access and that doors cannot be closed completely.**
-  **The disposal of the unit should be accomplished by appropriate personnel.** Remove doors to prevent accidents such as suffocation.
-  **Do not put the packing plastic bag within reach of children** as suffocation may result.
-  **Do not position this unit and the other unit so that it is difficult to operate the disconnection of the power supply plug.** Failure to disconnect the power supply plug may cause fire if there is something wrong with the unit.

PRECAUTIONS FOR SAFE OPERATION

CAUTION

-  This unit must be plug into a dedicated circuit protected by branch circuit breaker.
-  Use a dedicated power source as indicated on the rating label attached to the unit. A multiple-tap may cause fire resulting from abnormal heating.
-  **Connect the power supply plug to the power source firmly after removing the dust on the plug.** A dusty plug or improper insertion may cause a heat or ignition.
-  **Never store corrosive substances such as acid or alkali** in this unit if the container cannot be sealed. These may cause corrosion of inner components or electric parts.
-  **Check the setting when starting up of operation after power failure or turning off of power switch.** The stored items may be damaged due to the change of setting.
-  **Be careful not to tip over the unit** during movement to prevent damage or injury.
-  **Prepare a safety check sheet** when you request any repair or maintenance for the safety of service personnel.
-  Fix the shelves securely. Incomplete installation may cause injury or damage.



ENVIRONMENTAL CONDITIONS

This equipment is designed to be safe at least under the following conditions (based on the IEC 61010-1):

- Indoor use;
- Altitude up to 2000 m;
- Temperature 5 °C to 40 °C
- Maximum relative humidity 80 % for temperature up to 31 °C decreasing linearly to 50 % relative humidity at 40 °C;
- Mains supply voltage fluctuations up to ± 10 % of the nominal voltage;
- Transient overvoltages up to the levels of OVERVOLTAGE CATEGORY II;
- Temporary OVERVOLTAGES occurring on the mains supply;
- Applicable pollution degree of the intended environment (POLLUTION DEGREE 2 in most cases);

SYMBOLS ON UNIT

The symbols are attached to the ultra-low temperature freezer. The following table describes the symbols.

	This symbol is attached to covers that access high-voltage electrical components to prevent electric shock. Only a qualified engineer or service personnel should be allowed to open these covers.
	This symbol indicates that caution is required. Refer to product documentation for details.
	This symbol indicates an earth.
	This symbol means "ON" for a power switch.
○	This symbol means "OFF" for a power switch.

FREEZER COMPONENTS

Freezer unit

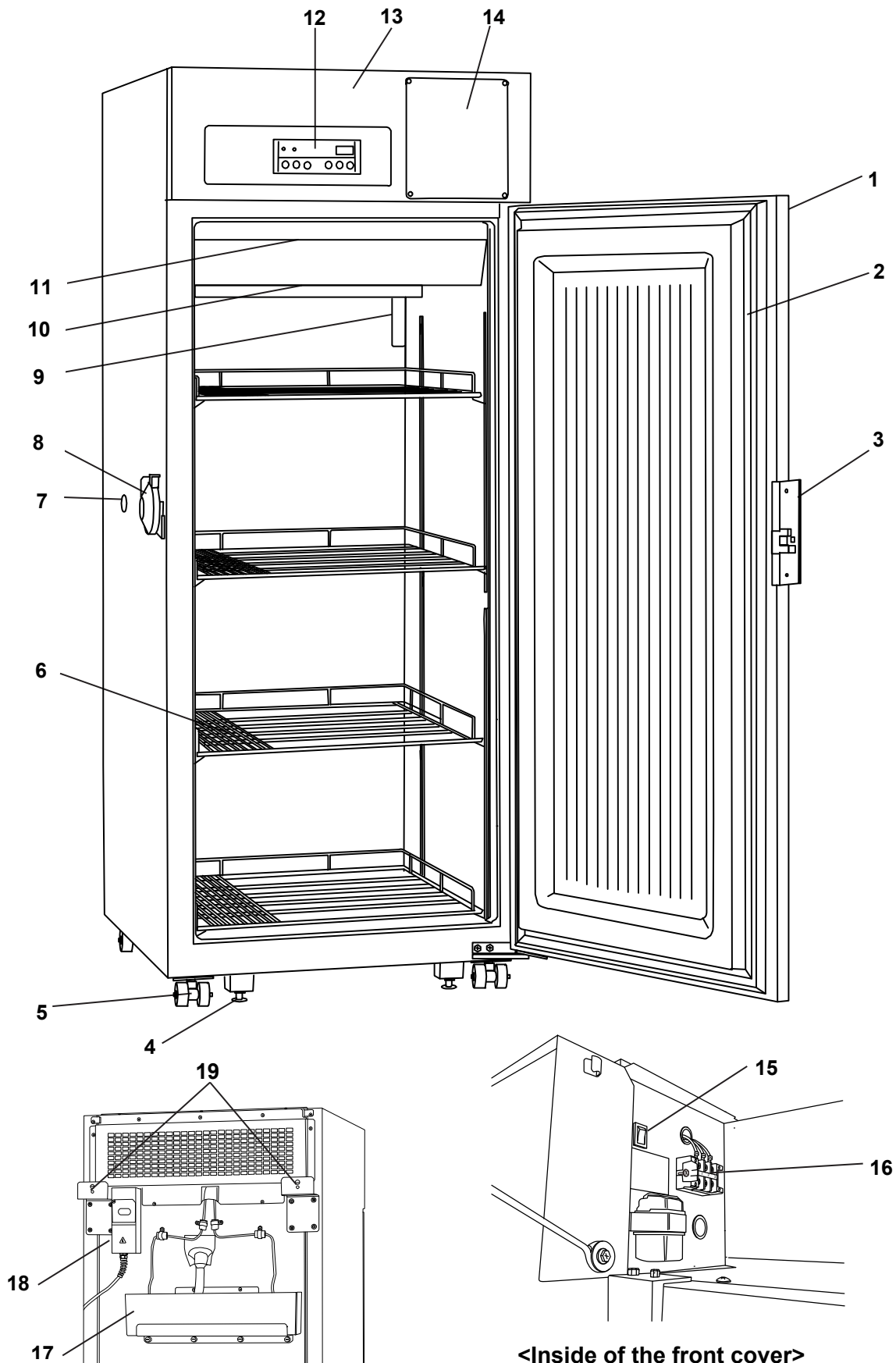

FREEZER COMPONENTS

- 1. Lock:** Turn clockwise to 90 ° with a key and the door is securely locked.
- 2. Magnetic door gasket:** This prevents the cold air from escaping. Always keep clean.
- 3. Handle:** Always grip this handle to open and close the door.
- 4. Leveling foot:** These are screw bolts used to install and fix the unit. Adjust the height of the leveling feet by turning the screw bolts until 2 front casters are away from the floor.
- 5. Caster:** 4 casters are provided to facilitate moving of the cabinet. For the installation, adjust the leveling foot so that the front two casters cannot contact with the floor.
- 6. Shelf:** Items to be stored in the chamber must be placed on the shelves. The maximum storage weight for each shelf is 50 kg.
Note: Fix the shelf stopper and shelves securely. Incomplete installation may cause injury or damage. Never touch the storage items with wet hands. Touching with the wet hands may cause frostbite.
- 7. Access port:** This is used for leading the measuring cable from the chamber to the outside. A total of two (2) are provided. ; left side and top of the freezer.
- 8. Door latch:** Turn clockwise to lock the door and also add the lock too.
- 9. Temperature sensor:** Located on the rear of the chamber.
- 10. Cold air exhaust vent:** Ensure this vent is never blocked. If this vent is blocked, temperature regulation become unstable. Do not place stored item in the path of cold air.
- 11. Air intake vent:** Ensure this vent is never blocked. Failure to do so will result in unstable temperature distribution in the chamber.
- 12. Control panel:** The operation status is displayed on this panel. And the temperature setting is available through this panel. Refer to page 10 for details.
- 13. Front cover:** Open this cover when connecting the remote alarm or using the power supply outlet.
- 14. Space for temperature recorder:** Space for a temperature recorder (optional component) is available separately. See page 21 “TEMPERATURE RECORDER (OPTION)”.
- 15. Battery switch:** Switch for battery used for power failure alarm. Always keep ON. Turn the switch OFF when the unit is in no use for a long period (more than one month).
- 16. Remote alarm terminal:** Used to notify an alarm condition of the unit to remote location. See page 14 for details.
- 17. Evaporating tray (back side):** Defrost water from the evaporator accumulates in the evaporating tray and evaporates into the atmosphere. See page 17 for cleaning.
- 18. Power switch (back side):** This is for turning ON/OFF the power to the unit. ON – “I” OFF – “O”
- 19. Fixture (back side):** These keep the adequate apace between the unit and wall, and also can be used for fixing the unit.

FREEZER COMPONENTS

Control panel

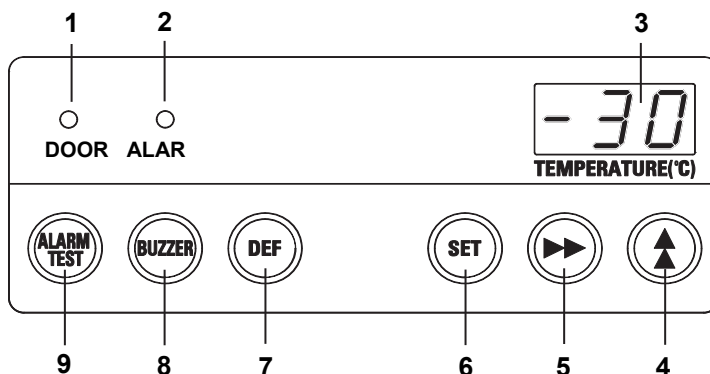

1. Door check lamp (DOOR): This lamp is lit when the door is open.

2. Alarm lamp (ALARM): This lamp is flashed during alarm condition.

3. Temperature display: This indicator shows the chamber temperature, set temperature, or error code.

4. Numerical value shift key (▲): Pressing this key in the setting mode causes the numerical value to change. ON-OFF of key lock can be selected by pressing this key in the key lock setting mode.

5. Digit shift key (▶▶): Pressing this key in setting mode causes the changeable digits to move. Key lock is activated by pressing this key for more than five seconds in the temperature display mode. See "Key lock function" on page 14.

6. Set key (SET): At "temperature display mode"; pressing this key leads "chamber temperature setting mode".

At "setting mode"; stores the value into computer memory.

7. Defrost key (DEF): When removing the frost, press this key for 5 seconds. The freezer operation is stopped. After removing the frost, press this key again.

Note: After the defrosting, the freezing operation is never resumed automatically. Make sure to press back in the freezer chamber.

8. Buzzer stop key (BUZZER): Press this key to silence the buzzer in the event that the alarm operates and buzzer sounds. See page 15, 16 for the details.

9. Alarm test key (ALARM TEST): The lamp is blinks and buzzer will sound and remote alarm will be activated by pressing this key.

INSTALLATION SITE

To operate this unit properly and to obtain maximum performance, install the unit in a location with the following conditions:

■ **A location not subjected to direct sunlight**

Do not install the unit under direct sunlight. Installation in a location subjected to direct sunlight cannot obtain the intended performance.

■ **A location with adequate ventilation**

Leave at least 10 cm around the unit for ventilation. Poor ventilation will result in a reduction of the performance and consequently the failure.

■ **A location away from heat generating sources**

Avoid installing the unit near heat-emitting appliances such as a heater or a boiler etc. Heat can decrease the intended performance of the unit.

■ **A location with little temperature change**

Install the unit under stable ambient temperature. The allowable ambient temperature is between +5 °C and +30 °C.

■ **A location with a sturdy and level floor**

Always install the unit on a sturdy and level floor. The uneven floor or tilted installation may cause failure or injury. Install the unit in stable condition to avoid the vibration or noise. Unstable condition may cause vibration or noise.

 **WARNING**

Install the unit on a sturdy floor. If the floor is not strong enough or the installation site is not adequate, this may result in injury from the unit falling or tipping over.

Select a level and sturdy floor for installation. This precaution will prevent the unit from tipping. Improper installation may result in water spillage or injury from the unit tipping over.

■ **A location not prone to high humidity**

Install the unit in the ambient of 80 %R.H. or less humidity. Installation under high humidity may cause current leakage or electric shock.

 **WARNING**

Do not use the unit outdoors. Current leakage or electric shock may result if the unit is exposed to rain water.

Never install the unit in a humid place or a place where it is likely to be splashed by water. Deterioration of the insulation may result which could cause current leakage or electric shock.

■ **A location without flammable or corrosive gas**

Never install the unit in a location where it will be exposed to flammable or corrosive gas. This may cause explosion or fire or may result in the current leakage or electric shock by the corrosion of the electrical components.

■ **A location without the possibility of anything fall**

Avoid installing the unit in the location where anything can fall down onto the unit. This may cause the breakdown or failure of the unit.

INSTALLATION

1. Removing the packaging materials and tapes

Remove all transportation fixed metal fittings (the side of the left) (Fig. 1) and tapes. Open the doors and ventilate the unit. If the outside panels are dirty, clean them with a diluted neutral dishwashing detergent.

- ◇ Undiluted detergent can damage the plastic components. For the dilution, refer to the instruction of the detergent.)
- ◇ After the cleaning with the diluted detergent, always wipe it off with a wet cloth. Then wipe off the panels with a dry cloth.

Note:

Remove the cable tie banding the power supply cord. Prolonged banding may cause the corrosion of the cord coating.

2. Removal of the door fixed plate

The door of the product is fixed by the door fixed plate. A screw hole should fix an attached plastic screw on the product. (4 places) (Fig. 1)

3. Adjusting the leveling foot

Stretch the leveling feet by rotating them to contact them to the floor. Ensure the unit is installed horizontally. (Fig. 2)

4. Fixing the unit

Two fixtures are attached to the rear of the frame. Fix the frame to the wall with these fixtures and rope or chain. (Fig. 3)

5. Ground (earth)

The ground (earth) is for preventing the electric shock in the case of unexpected deterioration of the electrical insulation. Always ground the unit at the time of installation.

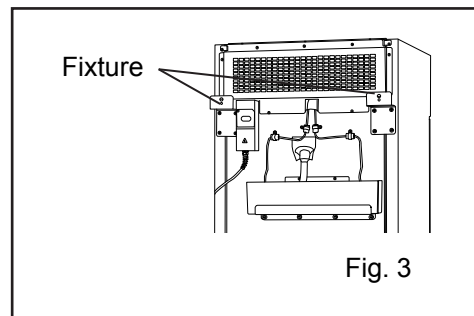
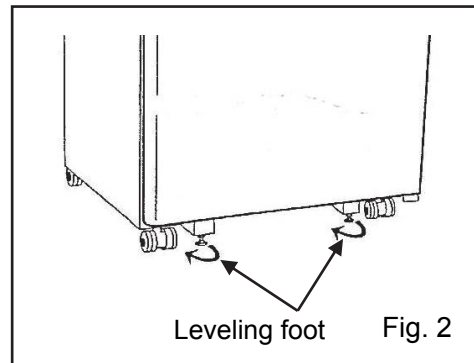
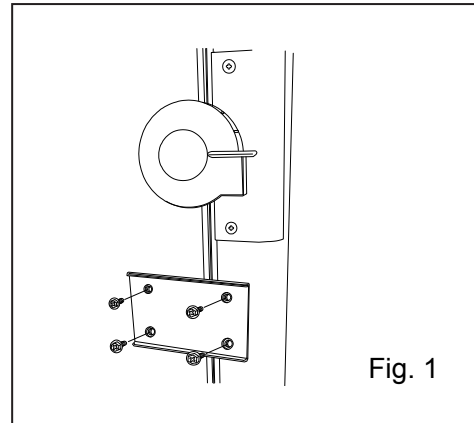

⚠ WARNING

Use a power supply outlet with ground (earth) to prevent electric shock. If the power supply outlet is not grounded, it is necessary to install a ground by qualified engineers.

Never ground the unit through a gas pipe, water main, telephone line or lightning rod. Such grounding may cause electric shock in the case of an incomplete circuit.

START-UP OF UNIT

Use the following procedure to start trial operation or actual operation of the unit.

1. A power supply plug is connected with the power supply without putting samples in the product.
2. A power switch and a battery switch are turned on.
3. Push a buzzer stop key (BUZZER), and stop a buzzer though a buzzer may ring.
4. Set up chamber temperature.
5. Check that chamber temperature gets cold to setup temperature.
6. An alarm test key (ALARM TEST) is pushed, and an alarm lamp flashed, and it is checked that a buzzer rings. At this time, a remote alarm works, too. (When a remote alarm terminal is being used.)
7. Put the storage samples by the above inspection so that chamber temperature may not rise when it is completely normal.

< Important >

Do not block the air intake vent or air exhaust vent in the freezer. Arrange the storage items with adequate space to keep the air circulation.

A sample deteriorates when chamber temperature rises.

Operation after power failure

The set value is memorized by nonvolatile memory. Accordingly, the freezer resumes the operation with setting before power failure.

Note:



As for the after power failure, a product may not start by the voltage descent and so on so that all machines may start at the same time. Be sure to check the operation conditions of the product.

TEMPERATURE SETTING

Table 1 shows the basic operation method. Perform key operations in the sequence indicated in the table. The example in the table is based on the assumption that the freezer temperature is -25 °C.

Note: The chamber temperature is set to -30 °C at the factory.

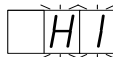
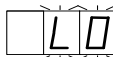
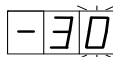
Table 1 Basic operation sequence (Example: Chamber temperature -25 °C)

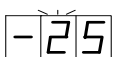
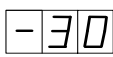
	Description of operation	Key operated	Indication after operation
1	Connect the power source and turn on the power switch.	----	The current chamber temperature is displayed. Chamber temperature higher than 1 °C to be displayed "HI" lower than -41 °C to be displayed "LO".  
2	Press set key.	SET	The first digit is flashed. 
3	Set the temperature to -25 with the digit shift key and the numerical value shift key.		When pressed, the settable digit shifted.
			When pressed, the figure of settable digit changes. 
4	Press set key.	SET	Set temperature is memorized and the current chamber temperature is displayed. 

◇The freezer temperature can be set in the range between -15 °C and -35 °C. Remember that the guaranteed temperature with no load at an ambient temperature of 30 °C is -30 °C.





◇The setting mode returns to the temperature display mode automatically when 90 seconds has passed without any key operation. In this case, any setting before pressing the set key (SET) is not memorized.

KEY LOCK FUNCTION

This unit is provided with the key lock function. When the key lock is ON, change of the setting through the key pad is not available. The key lock is set in OFF at the factory.

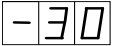
Display	Mode	Function
L o 0	Key lock is OFF	Enable to change of temperature setting
L o 1	Key lock is ON	Disable to change of temperature setting

Table 2 Procedure for key lock setting (change from key lock OFF to key lock ON)

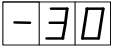
	Description of operation	Key operated	Indication after operation
1		----	The current chamber temperature is displayed. 
2	Press digit shift key for 5 seconds.		The first digit is displayed. 
3	Press numerical value shift key and scroll the figure to 1.		When pressed, the figure of settable digit changes. 
4	Press set key.	SET	The key lock is set to ON. The current chamber temperature is displayed. 

◇The setting mode returns to the temperature display mode automatically when 90 seconds has passed without any key operation. In this case, any setting before pressing the set key (SET) is not memorized.

◇The key lock only works with the chamber temperature setting and the defrost key (DEF).

A key lock function becomes on when it is changed to Lo1 with a process 3.

REMOTE ALARM TERMINAL

WARNING

Always turn off the power switch and disconnect the power supply cord before connecting an alarm device to the remote alarm terminal.

The terminal of the remote alarm is installed at the lower left side of the unit. The alarm is outputted from this terminal. Contact capacity is DC 30 V, 2 A.

	between COM. and N.O.	between COM. and N.C.
At normal	Open	Close
At abnormal	Close	Open

Note:

The alarm status of remote alarm terminal and audible alarm are cancelled by pressing the buzzer stop key (BUZZER) since the remote alarm is operated in conjunction with buzzer (except for power failure alarm status). The visual alarm will remain active until the alarm condition is rectified.

ALARMS FUNCTIONS

This unit has the alarm functions shown below.

Contact our sales representative or agent after moving the storage items to other refrigerator or freezer if the alarm status continues because there is a possibility of any failure.

Alarm & Safety	Situation	Indication	Buzzer	Remote alarm terminal
High temperature alarm	If the chamber temperature deviates by +10 °C (factory set) from setting.	Alarm lamp is flashed. Temperature display is flashed.	Intermittent tone after a delay of 15 minutes.	Remote alarm is activated after a delay of 15 minutes.
Low temperature alarm	If the chamber temperature deviates by -10 °C (factory set) from setting.	Alarm lamp is flashed. Temperature display is flashed.	Intermittent tone after a delay of 15 minutes.	Remote alarm is activated after a delay of 15 minutes.
Power failure alarm	In the case of power failure. When power switch is turned OFF. When the power to the unit is disconnected.	Alarm lamp is blinks.	Intermittent tone	Remote alarm is activated.
Door alarm	When the door is open.	Door check lamp is lit.	Intermittent tone after a delay of 2 minutes.	-----

◇ The remote alarm terminal is in alarm status in conjunction with the buzzer. However, the alarm status of the remote alarm terminal is cancelled by pressing the buzzer stop key (BUZZER).

SAFETY FUNCTIONS

This unit has the safety functions shown below.

Alarm & Safety	Situation	Indication, Buzzer	Safety operation
Auto return	When there is no key pressing in setting mode for 90 seconds.	-----	Finishing of setting mode and returning to the temperature display mode.
Key lock	When the key lock is ON (Lo1).	-----	The change of temperature setting is disable.

SELF DIAGNOSTIC FUNCTIONS

This unit has the self diagnostic functions shown below.

Contact our company sales representative or agent if an error code (ex. E01) is displayed resulting from the self diagnostic.

Alarm & Safety	Situation	Indication	Buzzer	Remote alarm terminal
Sensor Abnormality	If the thermal sensor goes open circuit.	Alarm lamp is flashed. E01 and LO are displayed alternately.	Intermittent tone	Alarm status
	If the thermal sensor goes short circuit.	Alarm lamp is flashed. E01 and HI are displayed alternately.		
	If the defrost sensor goes open circuit.	Alarm lamp is flashed. E02 and chamber temp. are displayed alternately.		
	If the defrost sensor goes short circuit.			
	If the compressor protection temperature sensor is disconnected.	Alarm lamp is flashed. E03 and chamber temp. are displayed alternately.		
	If the compressor protection temperature sensor is short circuited.			
Compressor temp. Abnormality	In case of failure of compressor cooling fan motor. In case of abnormal high ambient temperature. (when the temperature about 103 °C.)	Alarm lamp is flashed. E10 and chamber temp. are displayed alternately.		

◇The remote alarm is cancelled by pressing the buzzer stop key (BUZZER) since the remote alarm is operated in conjunction with the buzzer, except for the power failure alarm status.

◇After a power failure, the unit will resume operation with the set value that was in place before power failure occurred.

◇The chamber temperature is displayed for 5 seconds by pressing buzzer stop key (BUZZER) during power failure alarm. Then the buzzer is silenced. The alarm lamp keeps flashing.

◇The battery for power failure alarm is an article for consumption. It is recommended that the battery will be replaced about every 3 years. Contact our sales representative or agent at the time of replacement of the battery.

◇About 2-days operation of a freezer is necessary to full charge the battery.

◇Fan motor is expendable supplies. Replace them for about every 6 years. Contact our sales representative or agent at the time of replacement of the fan motor.

◇Attach the inspection label of the accessories in front of the product, and use the repair time of the battery and the fan motor.

◇The remote alarm terminal is in alarm status in conjunction with the buzzer. However, the alarm status of the remote alarm terminal is cancelled by pressing the buzzer stop key (BUZZER).

MAINTENANCE

⚠ WARNING

Always disconnect the power supply to the unit prior to any repair or maintenance of the unit in order to prevent electric shock or injury.

Ensure you do not inhale or consume medication or aerosols from around the unit at the time of maintenance. These may be harmful to your health.

⚠ CAUTION

Always put on the dry gloves to protect the hands at the time of maintenance. No gloves may cause cut of the finger by the edge or corner.

Cleaning of cabinet

Use a dry cloth to wipe off small amounts of dirt on the outside and inside of the unit and all accessories.

If the outside panels are dirty, clean them with a diluted neutral dishwashing detergent.

Wipe off the condensation on the exterior of the cabinet with a dry soft cloth.

◇ Undiluted detergent can damage the plastic components. For the dilution, refer to the instruction of the detergent.

◇ After the cleaning with the diluted detergent, always wipe it off with a wet cloth. Then wipe off the cabinet or accessories with a dry cloth.

<Important>

- Never pour water onto or into the unit. Doing so can damage the electric insulation and cause failure.
- Always replace the accessories removed for the cleaning to keep the intended performance.

Cleaning of evaporating tray

⚠ CAUTION

Dispose of the water in the evaporating tray completely. Spilled water or splashed water may cause current leakage or electric shock.

Clean the evaporating tray regularly. The dusty tray may cause poor evaporation.

This unit is provided with the evaporating tray on the back.

1. Remove 4 screws of the fixing bracket.
2. Remove the evaporating tray and the fixing bracket.
- 3 Wash the evaporating tray.
4. Fix the tray and the fixing bracket with 4 screws of the fixing bracket

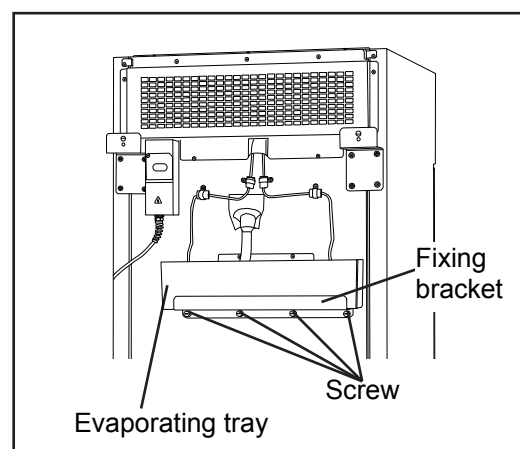

MAINTENANCE

Defrosting

Use the scraper provided for removing the frost if the freezer operation must be continued. Pay attention not to impact or damage the inner wall.

1. When defrosting, move all the contents of containers in the freezer to another low temperature freezer.
2. Pressing the defrost key (DEF) for more than five seconds to stop the freezing operation.

While the freezing operation is stopped, the current chamber temperature and dF is displayed on the control panel alternately.

3. After several hours, check the visually that all defrost was removed completely.

4. If a defroster is finished, a drain cap at bottom inside the freezer is removed.

Draw drain hose, and drain the water with water inside the freezer in the tray.

Wipe the water left in the freezer, and do the cap.

5. Pressing about 5 seconds the defrost key (DEF), the freezing operation can be started.

6. Once the chamber temperature has dropped to the desired temperature, place the original contents back in the freezer chamber.

Note:

After the defrosting, the freezing operation is never resumed automatically.

Make sure to press the defrost key (DEF) for more than five seconds to start operation again.

TROUBLESHOOTING

If the unit malfunctions, check out the following before calling for service.

Malfunction	Check/Remedy
The chamber is not cooled at all	<ul style="list-style-type: none"> <input type="checkbox"/> The circuit breaker of power source is active. <input type="checkbox"/> The voltage is too low? (In this case, call an electrician.) <input type="checkbox"/> The power switch is not ON. <input type="checkbox"/> The freezer is in defrost condition. <input type="checkbox"/> It is using near the electric product which makes an electric wave occur.
The cooling is poor	<ul style="list-style-type: none"> <input type="checkbox"/> The large amount of articles (load) is stored in the chamber at one time. <input type="checkbox"/> The ambient temperature is too high. <input type="checkbox"/> The door is not closed firmly. <input type="checkbox"/> The large amount of frost is built on the chamber wall. <input type="checkbox"/> The set temperature is not inputted properly. <input type="checkbox"/> The freezer is in the direct sunlight. <input type="checkbox"/> There is any heating source near the freezer. <input type="checkbox"/> A rubber cap and insulation for the access port are not set correctly. <input type="checkbox"/> You put too many unfrozen articles into the freezer compartment. <input type="checkbox"/> It is using near the electric product which makes an electric wave occur.
When the unit does not accept changes of set-point temperature	<ul style="list-style-type: none"> <input type="checkbox"/> The key lock is set in ON.
Noise	<ul style="list-style-type: none"> <input type="checkbox"/> The freezer is not installed on the sturdy floor. <input type="checkbox"/> The freezer is not leveled with the leveling feet. <input type="checkbox"/> There is anything touching the frame. <input type="checkbox"/> The freezer is in the status immediately after start up. <p>The unit sometimes causes a noise when the chamber temperature is high due to the large load. The noise gets less and less accompanying with the cooling of the chamber.</p>

Note:

If the malfunction is not eliminated after checking the above items, or the malfunction is not shown in the above table, contact our sales representative or agent.

Keep an electric product which emits an electric wave away from this product. A noise from an electric wave may cause malfunction to this product.

A compressor is in this product about the top of the product. After the operation of the compressor stops, it has the sound that refrigerant flows after several seconds. This makes the pressure of the compressor decrease, and it is the sound which makes it drive at the time of the next movement with little energy. This sound is not a problem.

CAUTION

The noise of refrigerant flow may be heard due to the characteristic of refrigerating circuit. Especially for several minutes after start-up, the noise of fan motor or refrigerant flow can be larger. But such noise does not mean malfunction nor failure.

DISPOSAL OF UNIT

WARNING

If the unit is to be stored unused in an unsupervised area for an extended period **ensure that children do not have access and doors cannot be closed completely.**

The disposal of the unit should be accomplished by appropriate personnel. Always remove doors to prevent accidents such as suffocation.

Recycle of battery

A nickel metal hydride battery that is recyclable powers the product you have purchased. Please call 1-800-8-BATTERY for information on how to recycle this battery.

L'appareil que vous vous êtes procuré est alimenté par une pile au nickel-métal-hydrure (NiMH). Pour des renseignements sur le recyclage de la pile, veuillez composer le 1-800-8-BATTERY.



Use the specified charger.



- Label indication is obliged to comply with Taiwanese battery regulation.

Decontamination of unit

Before disposing a unit with biohazardous danger, decontaminate the unit to the extent possible by the user.

REPLACEMENT OF WEAR-OUT PARTS

Replacement of battery for power failure alarm

Replace the battery for power failure alarm every 3 years to ensure the alarm is operated in the event of power failure. Contact our sales representative or agent for the replacement of battery.

- ✧ The alarm function (blink of alarm lamp, sound of buzzer) will not operate when the battery for power failure alarm is flat.
- ✧ The alarm lamp blinks and the buzzer sounds by the battery for power failure alarm. The regular replacement of the battery for power failure alarm is important to prevent the rise of chamber temperature in the case of unexpected situation.

<Important>

The used battery is a recyclable precious resource. Do not dispose of the battery. Always follow the procedure for recycling.

WARNING

The replacement of the battery for power failure alarm should be executed by a qualified engineer or service personnel only. The replacement of the battery for power failure alarm involves the risk of electric shock.

TEMPERATURE RECORDER (OPTION)

A temperature recorder is available for the freezer as an optional component. The type of the temperature recorder is MTR-G85A and MTR-4015LH. For the attachment, the recorder fixing is necessary. Contact our sales representative or agent for the installation of a temperature recorder.

SPECIFICATIONS

Product name	Biomedical Freezer MDF-U731
External dimensions	W770 mm x D830 mm x H1955 mm
Internal dimensions	W650 mm x D700 mm x H1370 mm
Effective capacity	623 L
Exterior	Painted steel
Interior	Painted steel
Door	Painted steel
Lock	1
Insulation	Rigid polyurethane foamed-in place
Shelf	Polyethylene coated wire 4 pieces Size: W626 mm x D620 mm Max. load: 50 kg/shelf
Access port	Diameter 30 mm, 1 port on left side 1 port on the top of unit
Cooling method	Forced air circulation
Compressor	Hermetic type, 450 W
Evaporator	Fin and tube
Condenser	Skin condenser type
Refrigerant	R-449A
Defrosting	Heater defrosting
Temperature controller	Electronics controller
Temperature display	Digital display (between -40 °C and +0 °C)
Temperature sensor	Thermistor sensor
Alarm & safety	High temp. alarm, Low temp. alarm, Power failure alarm, Door alarm, Compressor temperature alarm, Thermal sensor abnormality
Memory backup	Nonvolatile memory
Weight	155 kg
Battery	Nickel-metal-hydride battery, DC 6 V, 1500 mAh or 1100 mAh, Auto-recharge
Accessories	1 set of key, 1 Inspection label, 4 of plastic screws, 2 large & 2 small nylon clips (for temperature recorder)
Caster	4
Leveling foot	2
Optional component	Temperature recorder (MTR-G85A)+Recorder fixing (MPR-S7), Temperature recorder (MTR-4015LH)+ Recorder fixing (MPR-S30)

- Design or specifications will be subject to change without notice.
- Refer to the updated catalog when ordering an optional component.

PERFORMANCE

Product name	Biomedical Freezer MDF-U731
Model number	MDF-U731-PA
Cooling performance	-20 °C to -30 °C (ambient temperature; 5 °C to 30 °C, no load)
Rated voltage	AC 115 V
Rated frequency	60 Hz
Rated power consumption	380 W
Noise level	40 dB [A] (background noise; 20 dB)
Maximum pressure	2.26 MPa

- Specifications will be subject to change without notice.

⚠ CAUTION

**Please fill in this form before servicing.
Hand over this form to the service engineer to keep for his and your safety.**

Safety check sheet

1. Freezer contents :

- Risk of infection: Yes No
Risk of toxicity: Yes No
Risk from radioactive sources: Yes No

(List all potentially hazardous materials that have been stored in this unit.)

Notes :

2. Contamination of the unit

Unit interior

- No contamination Yes No
Decontaminated Yes No
Contaminated Yes No

Others:

3. Instructions for safe repair/maintenance/disposal of the unit

- a) The unit is safe to work on Yes No
b) There is some danger (see below) Yes No

Procedure to be adhered to in order to reduce safety risk indicated in b) below.

Date :

Signature :

Address, Division :

Telephone :

Product name: Biomedical Freezer	Model: MDF-	Serial number:	Date of installation:
-------------------------------------	----------------	----------------	-----------------------

Please decontaminate the unit yourself before calling the service engineer.

MEMO

PHC Corporation

1-1-1 Sakada, Oizumi-machi, Ora-gun, Gunma 370-0596, Japan

© PHC Corporation 2018



Printed in Taiwan
LDCL047300-1
T0418-10919