



Operating Instructions

Pharmaceutical Refrigerator

MPR-N450FSH

MPR-N450FH Series



MPR-N450FH

Please read the operating instructions carefully before using this product, and keep the operating instructions for future use.

See page 67 for all model numbers.

CONTENTS

INTRODUCTION	4
PRECAUTIONS FOR SAFE OPERATION.....	5
ENVIRONMENTAL CONDITIONS	10
SYMBOLS ON UNIT.....	11
REFRIGERATOR COMPONENTS	
Main body	12
Control panel	14
INSTALLATION SITE	15
INSTALLATION	16
START-UP PROCEDURE	17
AFTER RECOVERY FROM POWER FAILURE.....	17
HOME SCREEN (Temperature display screen)	18
MENU SCREEN	19
SETTING THE CHAMBER TEMPERATURE	21
SETTING THE KEYPAD LOCK.....	22
RELEASING THE KEYPAD LOCK	23
DISPLAY OF MAX/MIN TEMPERATURE.....	24
RESET OF MAX/MIN TEMPERATURE	25
SETTING THE PERIOD FOR MAX/MIN TEMPERATURE	26
DISPLAY AND EXPORT OF DATA LOG	
Display & export of temp. and door operation logs	27
Export of temperature and door operation logs.....	29
Setting the log interval	30
Setting the device ID	31
DISPLAY OF ALARM LOG	32
EXPORT OF ALARM LOG.....	33
SETTING THE SELECTABLE PARAMETERS	
Selectable parameters	34
Setting the temperature display	35
Setting the freezer defrosting	36
Setting the freezer alarm buzzer	37
Setting the high-temp. alarm of refrigerator.....	38
Setting the low-temp. alarm of refrigerator.....	39
Setting the high-temp. alarm of freezer.....	40
Setting the low-temp. alarm of freezer	41
Setting the door buzzer delay	42
Setting the buzzer suspended period	43
Setting the buzzer volume	44
Setting the remote alarm	45
Setting the interior light	46
Setting the compressor delay	47
Setting the device ID for data acquisition	48

CONTENTS

Setting the speed for data acquisition	49
Setting the remote control	50
Setting the date display (format)	51
Setting the date	52
Setting the time	53
REMOTE ALARM TERMINAL	54
ALARMS AND SELF-DIAGNOSIS	55
ROUTINE MAINTENANCE	
Cleaning of exterior, interior, and accessories	56
DEFROSTING	
Defrosting the refrigerator	57
Defrosting the freezer	57
TROUBLESHOOTING	58
DISPOSAL OF UNIT	59
Decontamination of unit	59
TEMPERATURE RECORDER (OPTION)	64
BATTERY KIT FOR POWER FAILURE ALARM (OPTION)	64
INTERFACE BOARD (OPTION)	64
CONTAINERS FOR FREEZER (OPTION)	64
ADDITIONAL SHELF KIT FOR FREEZER (OPTION)	65
LIGHT SHIELDING PLATE (OPTION)	65
SPECIFICATIONS	66
PERFORMANCE	67
SAFETY CHECK SHEET	68

INTRODUCTION

Read the operating instructions carefully before using the appliance and follow the instructions for safe operation.

Handling of Operating Instructions

■ PHC Corporation never guarantees any safety if the appliance is used for any objects other than intended use or used by any procedures other than those mentioned in the operating instructions.

■ Keep the operating instructions in an adequate place to refer to it as necessary.

■ Contact our sales representative or agent if any page of the operating instructions is lost or page order is incorrect.

■ Contact our sales representative or agent if any point in the operating instructions is unclear or if there are any inaccuracies.

◇The operating instructions is only for the pharmaceutical refrigerator MPR-N450FSH and MPR-N450FH made by PHC Corporation.

◇The contents are subject to change without notice.

◇No part of the operating instructions may be reproduced in any form without the expressed written permission of PHC Corporation.

Proposal for safe storage of freezer contents

This equipment is designed for storage of pharmaceuticals, samples and reagents. We can offer some precautions below to protect the valuable material against accidental temperature rise. Contact our sales representative or agent for the details or installation.

- Temperature recorder (Option)
- Battery kit for power failure alarm (Option)
- Remote alarm system (Marketed product)

IMPORTANT NOTICE

PHC Corporation guarantees this product under certain warranty conditions. However, please note that PHC Corporation shall not be responsible for any loss or damage to the contents of the product.

PRECAUTIONS FOR SAFE OPERATION

It is imperative that the user complies with the operating instructions as they contain important safety advice.

Items and procedures are described so that you can use this unit correctly and safely. Following these precautions will prevent possible injury to the user and any other person.

Precautions are illustrated in the following way:



WARNING

Warning indicates a potentially hazardous situation which, if not avoided, could result in serious injury or death.

CAUTION

Failure to observe CAUTION signs could result in injury to personnel and damage to the unit and associated property.

Symbols have the following meanings:

-  This symbol means caution.
-  This symbol means an action is prohibited.
-  This symbol means an instruction must be followed.













Be sure to keep the operating instructions in a place that is accessible to users of this unit.

For the State of California, USA Only:

This product contains a CR Coin Cell Lithium Battery which contains Perchlorate Material – special handling may apply. See www.dtsc.ca.gov/hazardouswaste/perchlorate.

PRECAUTIONS FOR SAFE OPERATION

WARNING

-  **Never damage the power supply cord or power supply plug (by breaking, adapting, placing near a source of heat, bending with force, twisting, pulling, adding weight, or binding).** A damaged power supply cord or power supply plug may cause electric shock, short circuit, or fire.
-  **Remove dust from the power supply plug periodically.** Dust on the power supply plug may cause insulation failure due to moisture and thus cause a fire. Disconnect the power supply plug and wipe it with a dry cloth.
-  **Make sure the power supply plug is pushed fully in.** Faulty insertion of the power supply plug may cause electric shock or fire due to generation of heat. Never use a damaged power supply plug or loose power outlet.
-  **Do not touch any electrical parts (such as power supply plug) or operate switches with a wet hand.** This may cause electric shock.
-  **Use a dedicated power source as indicated on the rating label attached to the unit.** A multiple-tap may cause fire resulting from abnormal heating.
-  **Do not use the unit outdoors.** Exposure to rain may cause leakage and/or electric shock.
-  **Only qualified engineers or service personnel should install the unit.** Installation by unqualified personnel may cause water leakage, electric shock, or fire.
-  **Install the unit in a location capable of bearing the total combined weight (product + optional accessories + stored items). After installing the unit, be absolutely sure to take precautions to prevent the unit from falling over.** If the unit is installed in a location which is not strong enough or if the proper precautions are not taken, the unit may fall over and cause injuries.
-  **Do not install the unit in a location where flammable or volatile substances are present.** Installing the unit in a location where flammable or volatile substances are present may cause explosions and/or a fire.
-  **Do not install the unit where there are high levels of moisture or where it may be splashed with water.** Installing the unit where there are high levels of moisture or where it may be splashed with water may cause the insulation to deteriorate and give rise to leakage and/or electric shock.
-  **Be absolutely sure to earth (ground) the unit in order to prevent electric shock.** Failure to earth the product may give rise to electric shock. If necessary, ask a qualified contractor to do this work.
-  **Do not connect the earth wire to a gas pipe, water pipe, or lightning rod when earthing the unit.** Earthing the unit improperly may give rise to electric shock.

PRECAUTIONS FOR SAFE OPERATION

WARNING

 **Never store volatile or flammable substances in this unit except in a sealed container.** Such substances may cause explosion or fire if they leak.

 **Never insert metal objects such as pins and wires into any vent, gap, or outlet on the unit.** This may cause electric shock or injury by accidental contact with moving parts.

 **When handling harmful samples (for example, those which consist of toxic, pathogenic, or radioactive substances), install the unit inside a designated isolation facility.** If the unit is installed in a location which is not an isolation facility, there may be detrimental effects on both people and the natural environment.

 **Before proceeding with maintenance or checking of the unit, set the power switch to OFF and disconnect the power supply plug.** Performing the work while power is still flowing to the product or while the power supply plug is still connected may give rise to electric shock and/or injury.

 **Wear protective gloves and mask during maintenance.** Touching or inhaling chemicals or aerosols from around the unit may be detrimental to health.

 **Never splash water directly onto the unit** as this may cause electric shock or short circuit.

 **Never put containers with liquid on top of the unit** as this may cause electric shock or short circuit if the liquid is spilled.

 **Never disassemble, repair, or modify the unit yourself.** A high-voltage area is located inside the unit. Any work carried out by unauthorized personnel may result in electric shock. Contact our sales representative or agent for maintenance or repair.

 **Disconnect the power supply plug if there is anything wrong with the unit.** Continued abnormal operation may cause electric shock or fire.

 **Grip the power supply plug when disconnecting the power supply cord from the outlet.** Pulling the power supply cord may cause electric shock or short circuit.

 **Disconnect the power supply cord when the unit is not in use for long periods.** Keeping the unit connected may cause electric shock, leakage, or fire due to the deterioration of insulation.

 **Do not place this unit in a location where it is difficult to disconnect the power supply plug.** Failure to disconnect the power supply plug may cause fire in the event of a problem or malfunction.

 **If the unit is to be stored unused in an unsupervised area for a long period, ensure that children do not have access and that doors cannot be closed completely.**

PRECAUTIONS FOR SAFE OPERATION

WARNING

 **Ask a qualified contractor to carry out disassembly and disposal of the unit.** Leaving the unit in a location that can be accessed by third parties may result in unexpected accidents (e.g. the unit may be used for unintended purposes).

 **Do not leave the plastic bags used for packing in a place where they can be reached by small children** as this may result in unexpected accidents such as suffocation.

 **When moving the unit, be sure to take precautions to prevent it from falling over.** Moving the unit with too much force may cause it to fall over, possibly resulting in injury. A qualified individual must be assigned to supervise the safe movement and relocation of the unit.

 **Do not install the unit in a location where corrosive gases such as acids are present.** Installing the unit in a location where corrosive substances are present may cause electric components to corrode, leading to leakage and/or electric shock due to the deterioration of insulation resulting from corroded electrical components.

 **Connect the unit to a power source as indicated on the rating label attached to the unit.** Use of any other voltage or frequency other than that on the rating label may cause fire or electric shock.

 **Wear protective gloves when handling frozen items in the chamber.** Touching frozen items directly may cause frostbite.

 **Always use the removal power supply cord that is provided.** Other power supply cord may cause electric shock or fire.

 **Never damage the chamber wall or pipework in the chamber when removing frost.** The refrigerant is flammable and may cause a fire if it leaks.

 **Install the unit in a well-ventilated (airy) location to prevent the accumulation of flammable refrigerant.** The flammable refrigerant may cause fire if it leaks.







 **Flammable and explosive product.** The unit contains flammable refrigerant. When repairing or recycling, only trained service personnel will repair and follow the procedure below.

- Well ventilate the room to prevent refrigerant accumulation.
- Keep fire away when the refrigerant is contained in the product.
- Do not damage or break the pipework.

 **Stop using the fire, open the windows for ventilation, and leave the unit as it is if the pipework is damaged or the leakage of flammable refrigerant is noticed. Then contact our sales representative or agent.** Disconnection or connection of the power supply plug may cause ignition, explosion, or fire.

PRECAUTIONS FOR SAFE OPERATION

CAUTION

-  **Do not climb on top of the unit or put any objects on the unit.** Falling from the unit may cause injury; falling objects may cause damage to the unit.
-  **Never install the unit in a location where corrosive materials such as sulphur compounds are likely to be generated (e.g. near a drainage facility).** Corrosion of the copper pipes may result in the deterioration and consequently the failure of the cooling unit.
-  **Before resuming operation after the unit has been turned off, be absolutely sure to check the settings.** The settings may have changed as a result of stopping the unit. Items stored inside the unit may be adversely affected if operation of the unit is resumed with changed settings.
-  **Never store corrosive substances such as acids or alkalis in the unit except in a sealed container.** These may be detrimental to health and may cause corrosion of internal components, cooling circuit or electrical components.
-  **Do not damage the glass or give it a shock.** The shelves in the refrigerator are tempered glass, but they can be broken or cause injury if they are used incorrectly.
-  **To ensure the safety of the service engineer, submit a safety check sheet with the required items filled out.** This is provided as the photocopyable “Safety Check Sheet” at the end of these operating instructions.





ENVIRONMENTAL CONDITIONS

This equipment is designed to be safe at least under the following conditions (based on the IEC 61010-1):

- Indoor use;
- Altitude up to 2000 m;
- Temperature 5 °C to 40 °C;
- Maximum relative humidity 80 % for temperature up to 31 °C decreasing linearly to 50 % relative humidity at 40 °C;
- Mains supply voltage fluctuations up to ± 10 % of the nominal voltage;
- Transient overvoltages up to the levels of OVERVOLTAGE CATEGORY II;
- Temporary OVERVOLTAGES occurring on the mains supply;
- Applicable pollution degree of the intended environment (POLLUTION DEGREE 2 in most cases);

SYMBOLS ON UNIT

The following symbols are attached to the unit. The table describes the meaning of the symbols.

	This symbol is attached to covers that access high-voltage electrical components to prevent electric shock. Only a qualified engineer or service personnel should be allowed to open these covers.
	This symbol indicates that caution is required. Refer to product documentation for details.
	This symbol indicates incorrect usage could lead to a fire hazard.
	This symbol indicates a hot surface.
	This symbol indicates an earth.
	This symbol means "ON" for a power switch.
○	This symbol means "OFF" for a power switch.

REFRIGERATOR COMPONENTS

Main body

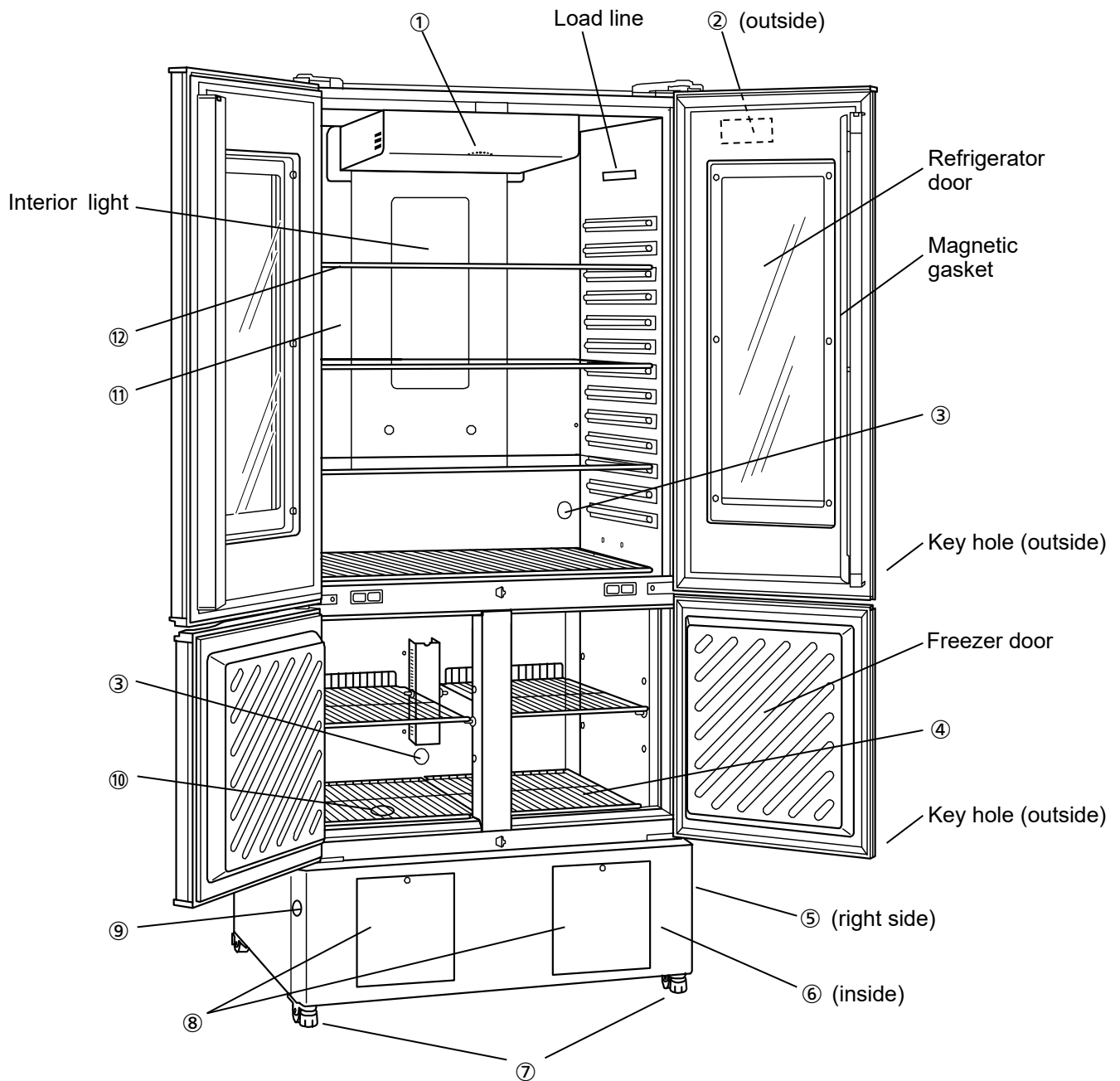

MPR-N450FH

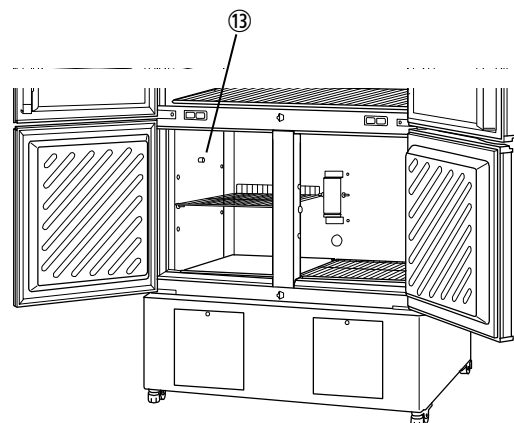

REFRIGERATOR COMPONENTS

- ① **Air intake vent:** This is an air intake vent for circulating the air in the chamber. Do not block this vent.
✧Blocking this vent may cause unstable chamber temperature.
- ② **Control panel:** The chamber temperature and other alarms/functions can be set using the keys on the control panel. The operational status can be checked on the temperature display and indicator [page 14].
- ③ **Access port:** This port is used to pass the sensor or cable of measuring equipment, or the sensor of a temperature recorder (optional) to the chamber.
✧Replace the insulation and the rubber caps when the access port is not in use. Improper replacement may cause an increase in chamber temperature or condensation around the access port.
- ④ **Bottom shelf:** Always put this shelf on the bottom of the freezer to protect the storage items.
- ⑤ **Power switch(also functions as a circuit breaker) :** This is the power switch of the unit. (ON=" | ", OFF="○")
✧The round button under the power switch is a test button for the circuit breaker. After pressing this button, the power to the unit is disconnected.
- ⑥ **Remote alarm terminal (inside):** A remote alarm device (separately available) can be connected to this terminal. The remote alarm relays the alarm to an operator in a remote location if the unit is unattended.
✧Contact our sales representative or agent to arrange the installation.
- ⑦ **Leveling foot (front):** These are screw bolts used to install and fix the unit. Adjust the height of the levelling feet by turning the screw bolts until the two front casters are away from the floor [page 16].
- ⑧ **Space for temperature recorder:** A temperature recorder (optional) can be mounted here so that the chamber temperature can be recorded automatically [page 64].
✧Contact our sales representative or agent to arrange the installation.
- ⑨ **Drain hose cap:** This is used to drain the defrost water in the freezer chamber at the time of defrosting. The drain hose is accessible by removing the drain hose cap [page 57].
✧Always replace the drain hose cap after draining.
- ⑩ **Drain port:** This port is used to drain the defrost water in the freezer chamber.
✧Always replace the port cap after draining.
- ⑪ **Air exhaust vent (around the interior light):** This is an air exhaust vent for circulating the air in the chamber. Do not block this vent.
✧Blocking this vent may cause unstable chamber temperature.
- ⑫ **Glass shelf:** This is made of tempered glass, but do not add the excessive force.
- ⑬ **Defrost indicator (small red projection):** Remove the frost in the freezer when this indicator is covered with the frost [page 57].

REFRIGERATOR COMPONENTS

Control panel

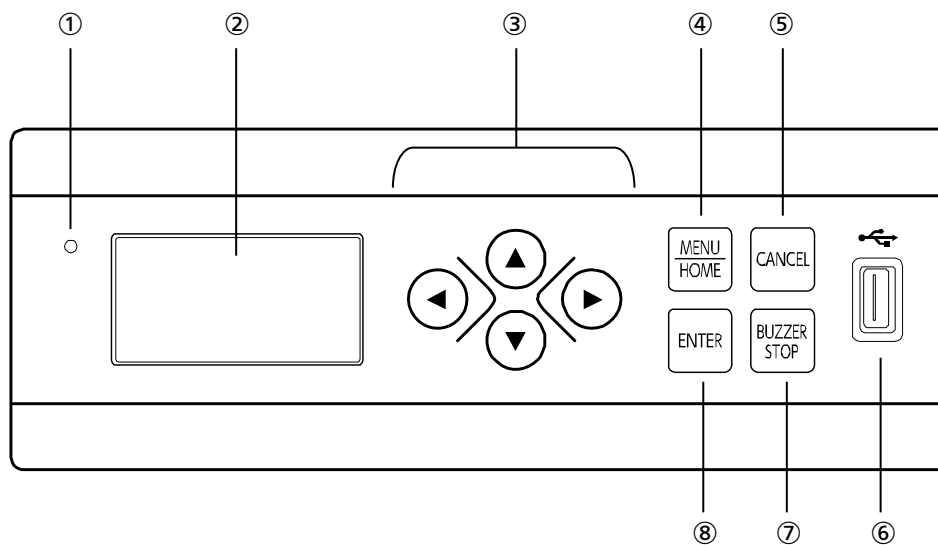

① **LED indicator:** In normal operation, the green LED lamp lights up, and during alarm condition, the red LED lamp blinks to indicate alarm.

② **Temperature display:** The present chamber temperature, log chart, or input screen, etc. are displayed.

③ **Up/down/left/right key ($\Delta \nabla \triangleleft \triangleright$):**

On the "home screen (temperature display screen)": pressing this key changes the display.

On the screen "other than the home screen": pressing this key moves the cursor, etc.

④ **Menu key (MENU/HOME):**

On the "home screen (temperature display screen)": pressing this key leads the menu screen. It is possible to set various setting on the menu screen.

On the screen "other than the home screen": pressing this key leads the home screen.

⑤ **Cancel key (CANCEL):** On the setting screen, pressing this key changes into the screen of one level up.

⑥ **USB port:** Insert a USB memory device to export data logs.

✧Do not insert anything other than a USB memory device.

⑦ **Buzzer stop key (BUZZER STOP):** The buzzer is silenced by pressing this key when the buzzer sounds.

⑧ **Enter key (ENTER):** Press this to select the menu item. Press this key to enter the required value during the setting procedure.

INSTALLATION SITE

This unit must be installed in a location which meets all the conditions described below.

✧ If the unit is installed in a location which does not meet the conditions, its specified performance may not be achieved or malfunctions and accidents may occur.

■ A location not exposed to direct sunlight

Avoid any location which is exposed to direct sunlight. Installing the unit in a location exposed to direct sunlight may reduce its cooling performance.

■ A well-ventilated (airy) location

In order to ensure ventilation, leave clearances of at least 10 cm around the unit (at the left, right, top and back). Blocking the ventilation may reduce the unit's cooling performance or cause malfunctions.

■ A location away from sources of heat

Avoid any location which is close to a major source of heat (such as a heater or boiler). Installing the unit near a major source of heat may reduce the unit's cooling performance.

■ A location with minimal changes in temperature

Avoid any location where the ambient temperature is subject to sudden changes. If the unit is installed in a location where the ambient temperature is subject to sudden changes, it will not be possible to achieve a stable cooling performance.

■ A flat surface where the floor is also capable of bearing the total combined weight (product + optional accessories + stored items)

Install the unit on a flat surface which is even and which is capable of bearing the total combined weight (product + optional accessories + stored items). If the unit is installed where the surface is uneven or where the unit will be inclined at an angle, the unit will be unstable, and accidents or injuries may occur and/or vibration or unnecessary noise may be generated.

■ A location with minimal humidity

Install the unit in a location where the relative humidity is less than 80 %R.H. Installing the unit in a very humid location may cause earth faults and/or electric shock.

■ A location free of flammable or corrosive gases

Avoid any location exposed to flammable or corrosive gases. Flammable or corrosive gases can cause explosions and/or a fire. Furthermore, corrosion of electrical parts may cause insulation to be reduced and result in earth faults and/or electric shock.

■ A location where nothing can fall onto the unit

Avoid locations where objects may fall onto the unit. Objects falling and hitting the unit may cause it to break down or fail.

INSTALLATION

1. Preparations after unpacking

Remove all the tape used to secure the doors and interior parts, and leave the doors open for a short while for ventilation.

If any surfaces of the outer cabinet are dirty, wipe the surface using a cloth moistened with a diluted neutral dish-washing detergent.

✧ Using an undiluted solution of detergent may cause the unit's plastic areas to crack. Follow the directions on the detergent for details of dilution.

✧ After wiping the unit using the diluted detergent, be absolutely sure to wipe the surfaces with a cloth dipped in clean water to remove traces of the detergent. After this, be absolutely sure to wipe the surfaces with a dry cloth, allowing the surfaces of the outer cabinet to dry out completely, and then proceed with the installation.

Note:

Remove the cable tie that binds the power supply cord. Prolonged contact with the tie may cause corrosion of the cord coating.

2. Securing and levelling the unit using the levelling feet

Rotate the front levelling feet clockwise until the casters are raised 5 mm to 10 mm above the floor surface [Fig. 1].

In addition, rotate the levelling feet slightly clockwise or anticlockwise, and adjust them so that the unit is completely level.

✧ When the casters are raised from the floor surface, the unit will be secured. If they are left touching the floor, the unit may accidentally move when its door is opened or closed.

3. Securing the unit by using the fixtures

Use the fixtures on the rear panel of the unit, and secure the unit to a wall with a strong rope or chain [Fig. 2].

4. Preventing electric shock by earthing the unit

When installing the unit, be absolutely sure to earth (ground) it. Earthing is necessary to prevent electric shocks resulting from deterioration of electrical insulations.

✧ This unit comes with a 3-pin plug having one earth pin. Earthing is not required in the case of a 3-pin power outlet equipped with an earth contact.

✧ If the power outlet is not a 3-pin outlet equipped with an earth contact, ask a qualified contractor to do the earthing work.

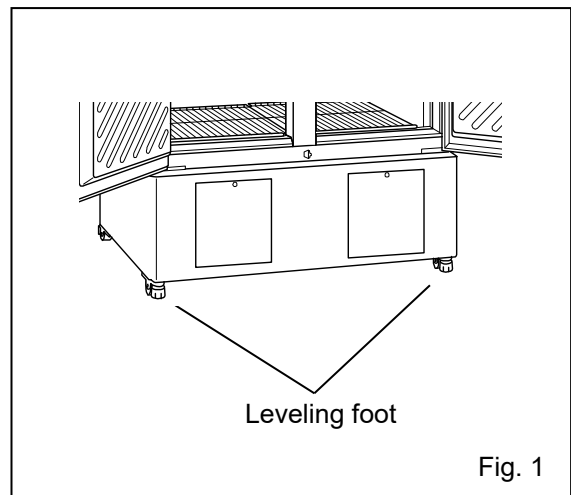

Fig. 1

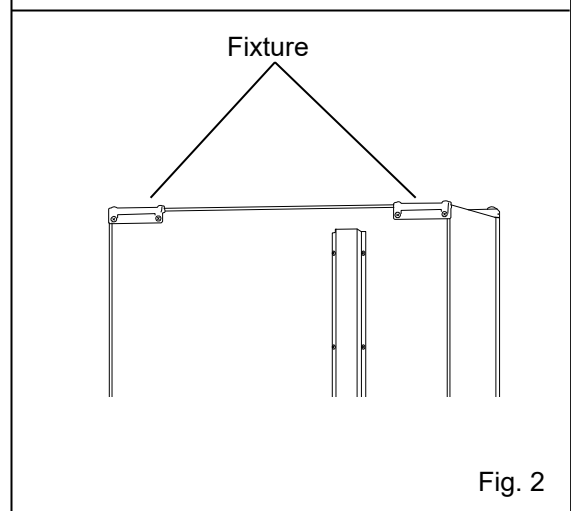

Fig. 2

START-UP PROCEDURE

Follow this procedure for the initial operation of the unit and for consequent operations (after temporary stoppage for cleaning, maintenance or moving) .

◇After a power failure, the unit will restart operation automatically with the same settings as before the power failure.

1. Connect the power supply cord to the dedicated power source with the appropriate rating with the chamber empty, and turn on the power switch.

▶When the power is switched on, the home screen (temperature display screen) is displayed. The red LED indicator blinks. (This is caused by the high-temperature alarm function and is not a malfunction.)

2. Set the date and time displayed on the temperature display to the current date and time [pages 51 to 53].

3. Set the desired chamber temperature [page 21].

◇The factory setting of refrigerator chamber temperature is 5 °C and the freezer chamber temperature is -30 °C.

4. Using the temperature display, check that the chamber temperature has cooled to the set temperature.

5. Open the refrigerator door to check that the interior light is on.

6. Gradually place the material inside the chamber.

◇Putting a large amount of material into the chamber at one time causes the temperature to rise.

◇Do not block the air intake vent nor air exhaust vent in the refrigerator chamber.

<Important>

The “load line” is indicated in the refrigerator chamber. Do not put materials on the location higher than the “load line”.

◇The air flow is blocked and the cooling performance is degraded.

7. Set a selectable parameter (keypad lock, alarm temperature, delay of door alarm buzzer, etc.) as required [page 20].

<Important>

This unit is for storing items and do not use for other application.

<Attention>

The condensation may be found on the glass of refrigerator door under high temperature and humidity condition. Wipe off the condensation with a soft dry cloth (for MPR-N450FH).

AFTER RECOVERY FROM POWER FAILURE

After recovery from a power failure, the operation will resume automatically with the same settings as before the power failure. There is no need to re-set. However, always check the operational status after recovery.

◇The settings are memorized during power failure by nonvolatile memory.

HOME SCREEN (Temperature display screen)

When the power is switched on, the following home screen (temperature display screen) is displayed.

◇Following shows the integer display mode.

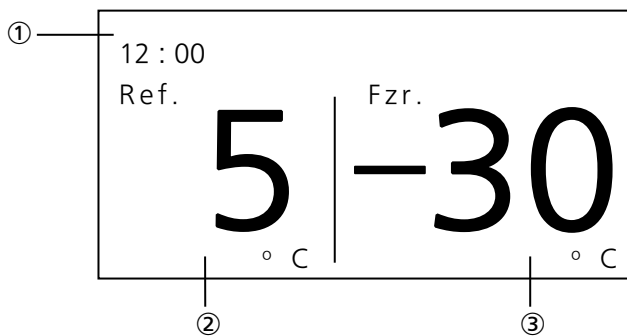

① Message column

Normally, the time (24-hour notation) is displayed. At the error, the error code and message are displayed.

② Refrigerator temperature display

The current refrigerator temperature is displayed. During the temperature alarm, the refrigerator temperature blinks.

③ Freezer temperature display

The current freezer temperature is displayed. During the temperature alarm, the freezer temperature blinks.

By pressing the right/left key (<|>), the temperature display is changed between “refrigerator & freezer temperature display”, “refrigerator temperature display”, and “freezer temperature display”.

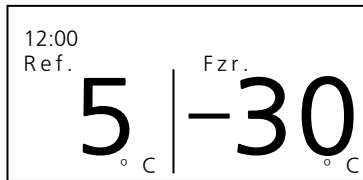

Refrigerator & freezer temp. display



Refrigerator temp. display

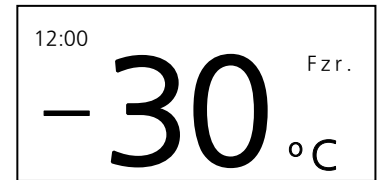

Freezer temp. display

<Change of display mode>

On the home screen, the temperature display is selectable; integer display mode or decimal display mode.

Following shows an example of decimal representation mode.

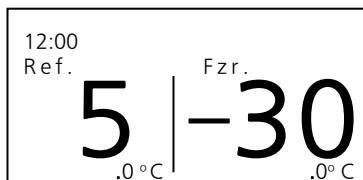

Refrigerator & freezer temp. display



Refrigerator temp. display

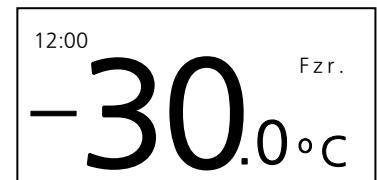

Freezer temp. display

Also in the decimal representation mode, by pressing the right/left key (<|>), the temperature display is changed between “refrigerator & freezer temperature display”, “refrigerator temperature display”, and “freezer temperature display”.

In both the integer display and decimal display, refrigerator temperature and freezer temperature are displayed repeatedly at certain interval when there is no key operation (sleeping mode).

MENU SCREEN

The menu screen is displayed by pressing the menu key (MENU/HOME) while the home screen (temperature display screen) is displayed. Following shows the menu screen.

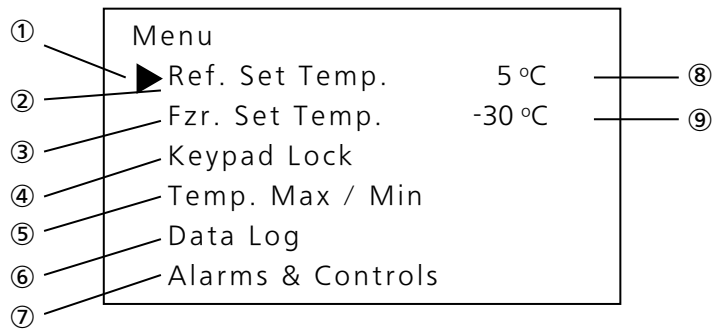

① Cursor

This is used for selecting the menu. The cursor moves by pressing the up/down key ($\Delta \nabla$).

② Refrigerator set temperature

Select this menu when changing the refrigerator set temperature. Moving the cursor to this menu and pressing the enter key (ENTER) lead the screen for setting the refrigerator temperature.

③ Freezer set temperature

Select this menu when changing the freezer set temperature. Moving the cursor to this menu and pressing the enter key (ENTER) lead the screen for setting the freezer temperature.

④ Keypad lock

Select this menu to set the keypad lock. Moving the cursor to this menu and pressing the enter key (ENTER) lead the screen for setting the keypad lock.

✦The setting can be locked to avoid accidental changes. When the keypad lock is ON, a change of setting is not accepted even if the key on the control panel is operated.

⑤ Temp. Max / Min

Select this menu to check the maximum or minimum chamber temperature (refrigerator or freezer) during every 12 hours or 24 hours. Moving the cursor to this menu and pressing the enter key (ENTER) lead the screen for selecting the maximum or minimum temperature display.

⑥ Data Log

Select this menu to display the log on the screen or export the log to a USB memory device. Moving the cursor to this menu and pressing the enter key (ENTER) lead the "Data Log" screen.

⑦ Alarms & Controls

Select this menu to set the high/low temperature alarm, or other parameters. Moving the cursor to this menu and pressing the enter key (ENTER) lead the "Alarms & controls" screen.

⑧ Display of setting temperature of refrigerator chamber

⑨ Display of setting temperature of freezer chamber

MENU SCREEN

Following shows the screen display and function at each screen under Menu level.

Note: The unit will return from setting mode to the home screen automatically after 90 seconds if no key is operated (auto-return function). In this case, the setting is not changed.

Screen	Function	Reference page
"Menu" screen		
"Ref. Set Temp." screen		
Ref. Set Temp.	Setting the refrigerator temperature	21
"Fzr. Set Temp." screen		
Fzr. Set Temp.	Setting the freezer temperature	21
"Keypad Lock" screen		
Keypad Lock ON/OFF	Setting the keypad lock (ON/OFF)	22 to 23
"Temp. Max/Min" screen		
Ref. Temp. Max/Min	Display of maximum and minimum refrigerator temperature	24
Ref. Temp. Reset	Reset of maximum and minimum refrigerator temperature	25
Fzr. Temp. Max/Min	Display of maximum and minimum freezer temperature	24
Fzr. Temp. Reset	Reset of maximum and minimum freezer temperature	25
Max/Min Interval	Setting the interval for maximum/minimum temperature display	26
"Data Log" screen		
Data Log Chart	Chart display of chamber temperature or door operation log	27 to 28
Data Log Export	Exporting the chamber temperature and door operation log	29
Data Log Setting	Setting the log interval, setting of device ID	30 to 31
Alarm	Display of alarm log	32
Alarm Export	Exporting the alarm log	33
"Alarms & Controls" screen		
1/10 Temp. Display	Setting the decimal display of temperature	35
"Freezer Setting" screen		
Fzr. Defrost ON/OFF	Setting the freezer defrosting	36
Fzr. Alarm ON/OFF	Setting the buzzer for freezer	37
"Alarm Setting #1" screen		
Ref. High Temp.	Setting the high-temperature alarm for refrigerator	38
Ref. Low Temp.	Setting the low-temperature alarm for refrigerator	39
Fzr. High Temp.	Setting the high-temperature alarm for freezer	40
Fzr. Low Temp.	Setting the low-temperature alarm for freezer	41
"Alarm Setting #2" screen		
Door Alarm Delay	Setting the delay of door alarm	42
Ring Back Delay	Setting the buzzer suspended period	43
Alarm Volume	Setting the buzzer volume	44
Remote ON/OFF	Setting the remote alarm	45
Interior Light	Setting the interior light	46
Comp. Delay	Setting the compressor delay	47
"DAQ Setting" screen		
DAQ ID	Setting the device ID for data acquisition	48
DAQ Speed	Setting the communication speed for data acquisition	49
Local/Remote	Setting the remote control	50
"Date & Time" screen		
Date Format	Setting the date display (format)	51
Date	Setting the date	52
Time	Setting the time	53

SETTING THE CHAMBER TEMPERATURE

Set the chamber temperature as required to keep the stored material at an appropriate temperature for a long period of time.

<Setting the refrigerator temperature>

- Setting range of chamber temperature: between 2 °C and 14 °C
- Initial setting (factory setting): 5 °C

1. On the home screen, press the menu key (MENU/HOME).

▶ The Menu screen is displayed [Fig. 1].

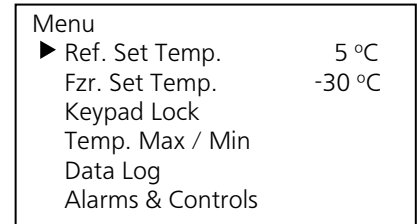

[Fig. 1]

2. With the cursor on the Ref. Set Temp. , press the enter key (ENTER).

▶ The Ref. Set Temp. screen is displayed, and the current setting (05) is displayed [Fig. 2].

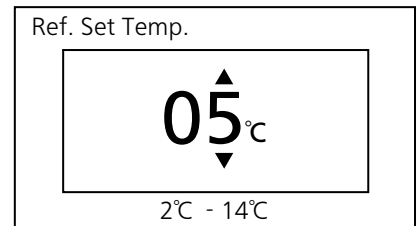

[Fig. 2]

3. By pressing the right or left key, move the cursor to select the digit to be changed. Then change the figure by pressing the up or down key.

4. Press the enter key (ENTER).

▶ The setting is memorized and the screen is changed to the Menu screen.

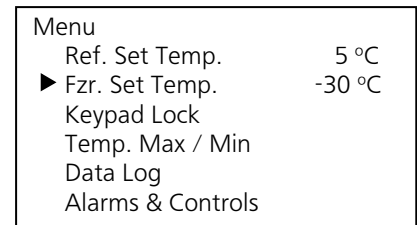

[Fig. 3]

5. Press the menu key (MENU/HOME) to display the home screen.

◇ The display returns to the home screen automatically when 90 seconds has passed without any key operation.

<Setting the freezer temperature>

- Setting range of chamber temperature: between -35 °C and -15 °C
- Initial setting (factory setting): -30 °C

1. On the home screen, press the menu key (MENU/HOME).

▶ The Menu screen is displayed [Fig. 1].

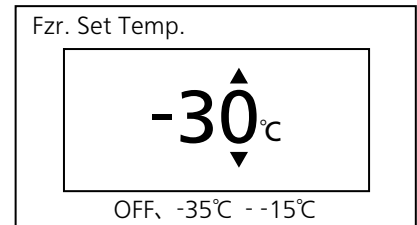

[Fig. 4]

2. Move the cursor to the Fzr. Set Temp. by pressing the up or down key [Fig. 3], and press the enter key (ENTER).

▶ The Frz. Set Temp. screen is displayed, and the current setting (-30) is displayed [Fig. 4].

3. By pressing the right or left key, move the cursor to select the digit to be changed. Then change the figure by pressing the up or down key.

◇ The freezer operation stops when -00 is set, select OFF by pressing the down key and then press the enter key (ENTER). On the temperature display, -- is displayed. The freezer temperature is not displayed at the time of no key operation (sleeping mode).

4. Press the enter key (ENTER).

▶ The setting is memorized and the screen is changed to the Menu screen.

5. Press the menu key (MENU/HOME) to display the home screen.

◇ The display returns to the home screen automatically when 90 seconds has passed without any key operation.

SETTING THE KEYPAD LOCK

The setting can be locked to avoid accidental changes. When the keypad lock is ON, a change of setting is not accepted even if the key on the control panel is operated.

1. On the home screen, press the menu key (MENU/HOME).
 - ▶ The Menu screen is displayed.
2. By pressing the up or down key, move the cursor to the Keypad Lock [Fig. 1] and then press the enter key (ENTER).
 - ▶ The Keypad Lock ON/OFF screen is displayed, and the current setting (OFF) is displayed [Fig. 2].
3. By pressing the up or down key, change the setting to ON.
 - ✧ The setting is changed to ON or OFF when the up or down key is pressed.
4. Press the enter key (ENTER).
 - ▶ The Keypad Lock PW screen is displayed [Fig. 3].
5. Input the password (6 digits) and press the enter key (ENTER).
 - ▶ The Confirm PW screen is displayed [Fig. 4].
6. Again input the password (6 digits) and press the enter key (ENTER).
 - ▶ The display returns to the Menu screen and LOCK is displayed on the upper right [Fig. 5].

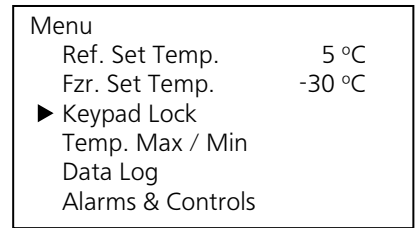

[Fig. 1]

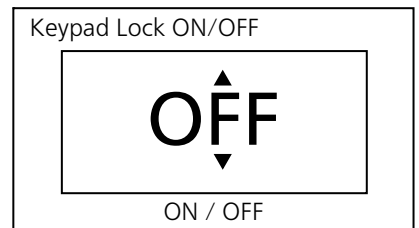

[Fig. 2]

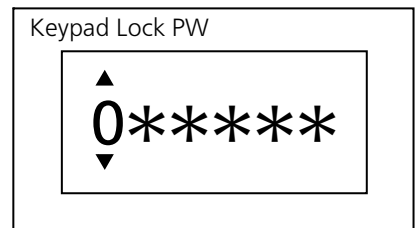

[Fig. 3]

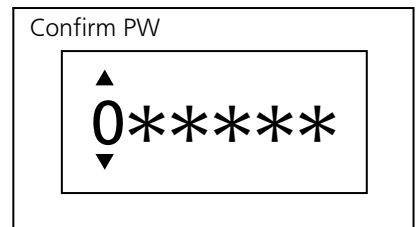

[Fig. 4]

Note: The following screen will be displayed when the second password does not comply with the first password.

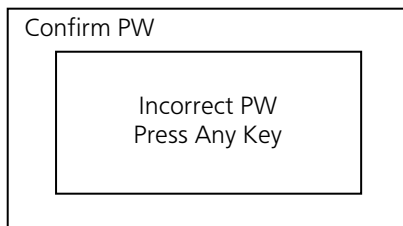

By pressing any key on the control panel, the display returns to the Menu screen. Start from the above procedure 2.

7. Press the menu key (MENU/HOME) to display the home screen.
 - ✧ The display returns to the home screen automatically when 90 seconds has passed without any key operation.

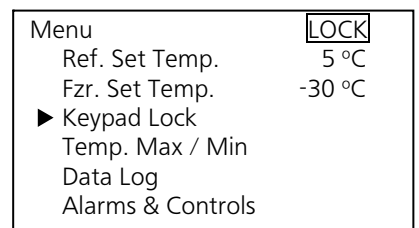

[Fig. 5]

RELEASING THE KEYPAD LOCK

When the keypad lock is OFF, a change of setting is acceptable.

1. On the home screen, press the menu key (MENU/HOME).
▶ The Menu screen is displayed.
2. By pressing the up or down key, move the cursor to the Keypad Lock [Fig. 1] and then press the enter key (ENTER).
▶ The Keypad Lock ON/OFF screen is displayed, and the current setting (ON) is displayed [Fig. 2].
3. By pressing the up or down key, change the setting to OFF.
◇ The setting is changed to ON or OFF when the up or down key is pressed.
4. Press the enter key (ENTER).
▶ The Keypad Lock PW screen is displayed [Fig. 3].
5. Input a password (6 digits) and press the enter key (ENTER).
▶ The display returns to the Menu screen and LOCK on the upper right is disappeared [Fig.4].

Note: The following screen will be displayed when the password does not comply with the set password.

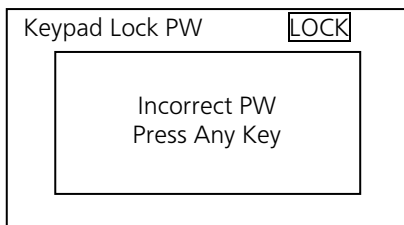

By pressing any key on the control panel, the display returns to the Menu screen. Start from the above procedure 2.

6. Press the menu key (MENU/HOME) to display the home screen.
◇ The display returns to the home screen automatically when 90 seconds has passed without any key operation.

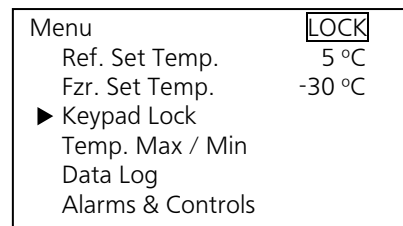

[Fig. 1]

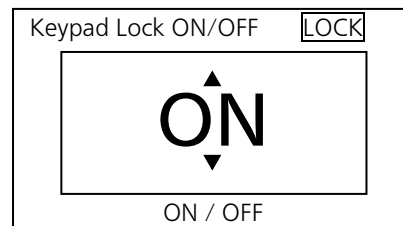

[Fig. 2]

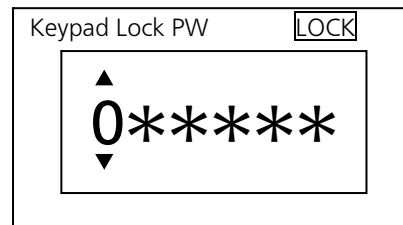

[Fig. 3]

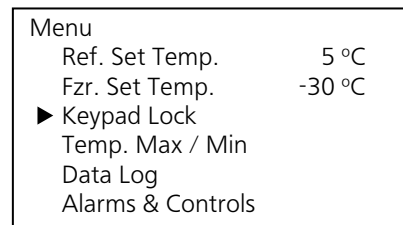

[Fig. 4]

DISPLAY OF MAX/MIN TEMPERATURE

On the temperature display, the maximum and minimum chamber temperature for every 24 or 12 hours can be checked.

- Initial setting (factory setting): 24 hours

1. On the home screen, press the menu key (MENU/HOME).

▶ The Menu screen is displayed.

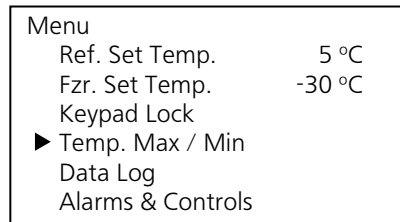

[Fig. 1]

2. By pressing the up or down key, move the cursor to the Temp. Max/Min [Fig. 1] and then press the enter key (ENTER).

▶ The Temp. Max/Min screen is displayed [Fig. 2].

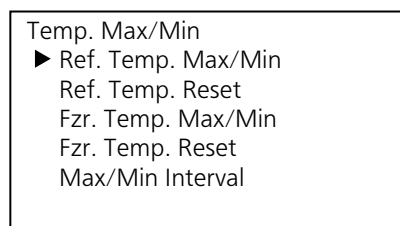

[Fig. 2]

<Display of maximum and minimum refrigerator temperature>

3. With the cursor on the Ref. Temp. Max/Min [Fig. 2], press the enter key (ENTER).

▶ The Ref. Temp. screen is displayed, and the maximum and minimum refrigerator temperature are displayed [Fig. 3].

◇ The display on the top (03/01 12:00) shows the start date and time of the monitor period (for 24 or 12 hours). The start date is March 1 and time is 12:00.

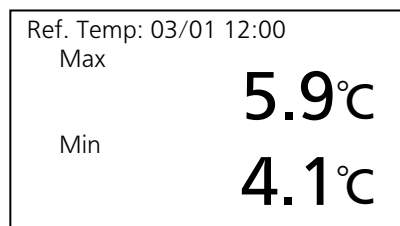

[Fig. 3]

4. Press the menu key (MENU/HOME) to display the home screen.

◇ The display returns to the home screen automatically when 90 seconds has passed without any key operation.

<Display of maximum and minimum freezer temperature>

3. By pressing the up or down key, move the cursor to the Fzr. Temp. Max/Min [Fig. 4] and then press the enter key (ENTER).

▶ The Fzr. Temp. screen is displayed, and the maximum and minimum freezer temperature are displayed [Fig. 5].

◇ The display on the top (03/01 12:00) shows the start date and time of the monitor period (for 24 or 12 hours).

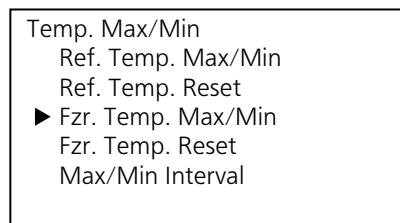

[Fig. 4]

4. Press the menu key (MENU/HOME) to display the home screen.

◇ The display returns to the home screen automatically when 90 seconds has passed without any key operation.

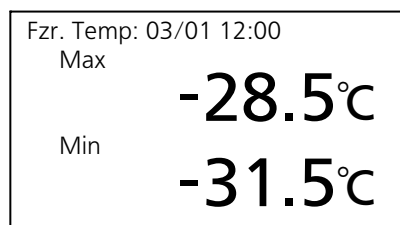

[Fig. 5]

RESET OF MAX/MIN TEMPERATURE

The maximum and minimum chamber temperature can be reset.

1. On the home screen, press the menu key (MENU/HOME).

▶ The Menu screen is displayed.

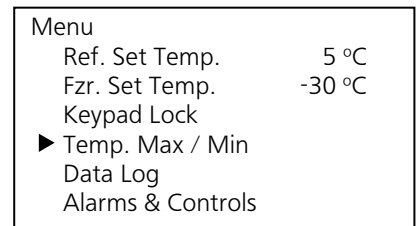

[Fig. 1]

2. By pressing the up or down key, move the cursor to the Temp. Max/Min [Fig. 1] and then press the enter key (ENTER).

▶ The Temp. Max/Min screen is displayed [Fig. 2].

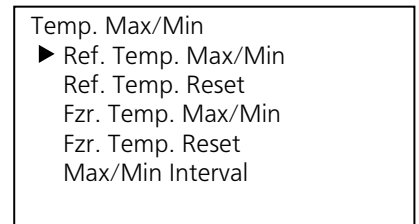

[Fig. 2]

<Reset of maximum and minimum refrigerator temperature>

3. By pressing the up or down key, move the cursor to the Ref. Temp. Reset [Fig. 3] and then press the enter key (ENTER).

▶ The Ref. Temp. Reset screen is displayed, and the current setting (NO) is displayed [Fig. 4].

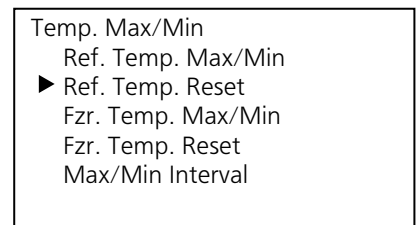

[Fig. 3]

4. By pressing the up or down key, change the setting to YES.

✧ The setting is changed to NO or YES when the up or down key is pressed.

5. Press the enter key (ENTER).

▶ The setting is memorized and the screen is changed to the Temp. Max/Min screen.

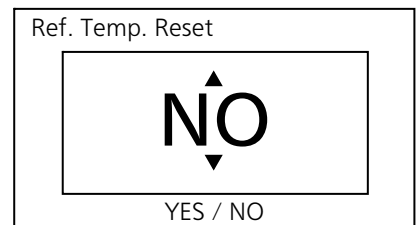

[Fig. 4]

6. Press the menu key (MENU/HOME) to display the home screen.

✧ The display returns to the home screen automatically when 90 seconds has passed without any key operation.

<Reset of maximum and minimum freezer temperature>

3. By pressing the up or down key, move the cursor to the Fzr. Temp. Reset [Fig. 5] and then press the enter key (ENTER).

▶ The Fzr. Temp. Reset screen is displayed, and the current setting (NO) is displayed [Fig. 6].

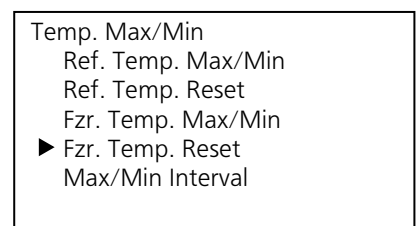

[Fig. 5]

4. By pressing the up or down key, change the setting to YES.

✧ The setting is changed to NO or YES when the up or down key is pressed.

5. Press the enter key (ENTER).

▶ The setting is memorized and the screen is changed to the Temp. Max/Min screen.

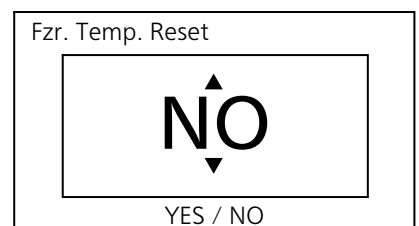

[Fig. 6]

6. Press the menu key (MENU/HOME) to display the home screen.

✧ The display returns to the home screen automatically when 90 seconds has passed without any key operation.

SETTING THE PERIOD FOR MAX/MIN TEMPERATURE

The period for monitoring the maximum and minimum chamber temperature is selectable. The monitor period is 24 hours or 12 hours.

The maximum and minimum chamber temperature for 24 hours are displayed when 24 hours is selected.

The maximum and minimum chamber temperature for 12 hours are displayed when 12 hours is selected.

- Initial setting (factory setting): 24 hours

1. On the home screen, press the menu key (MENU/HOME).

▶ The Menu screen is displayed.

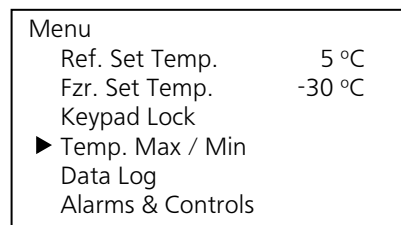

[Fig. 1]

2. By pressing the up or down key, move the cursor to the Temp. Max/Min [Fig. 1] and then press the enter key (ENTER).

▶ The Temp. Max/Min screen is displayed.

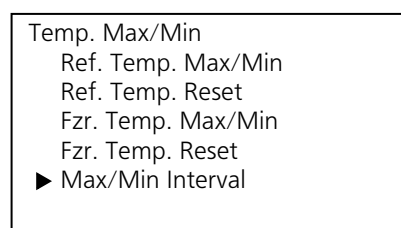

[Fig. 2]

3. By pressing the up or down key, move the cursor to the Max/Min Interval [Fig. 2] and then press the enter key (ENTER).

▶ The Max/Min Interval screen is displayed, and the current setting (24H) is displayed [Fig. 3].

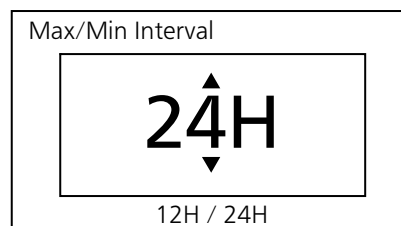

[Fig. 3]

4. By pressing the up or down key, change the setting to 12H.

◇ The setting is changed to 24H or 12H when the up or down key is pressed.

5. Press the enter key (ENTER).

▶ The setting is memorized and the screen is changed to the Temp. Max/Min screen.

6. Press the menu key (MENU/HOME) to display the home screen.

◇ The display returns to the home screen automatically when 90 seconds has passed without any key operation.

DISPLAY AND EXPORT OF DATA LOG

Display & export of temp. and door operation logs

The log of chamber temperature (refrigerator and freezer) and door operation (refrigerator and freezer) can be displayed by chart on the screen. Also, those logs can be exported to a USB memory device.

- On the home screen, press the menu key (MENU/HOME).
▶ The Menu screen is displayed.
- By pressing the up or down key, move the cursor to the Data Log [Fig. 1] and then press the enter key (ENTER).
▶ The Data Log screen is displayed [Fig. 2].
- With the cursor on the Data Log Chart [Fig. 2], press the enter key (ENTER).
▶ The R. Temp. screen (chart of refrigerator temperature) is displayed [Fig. 3].
- With the highlighted R. Temp. displayed on upper left [Fig. 3], press the enter key (ENTER).
▶ The Data Select screen is displayed [Fig. 4].
- By pressing the up or down key, select the data item to be displayed.
◇ The setting is changed to R. TEMP., F. TEMP, or DOOR when the up or down key is pressed.
R. TEMP.: Log of refrigerator temperature
F. TEMP.: Log of freezer temperature
DOOR: Log of door operation (refrigerator door and freezer door)

- Press the enter key (ENTER).
▶ The log is displayed in chart.

Note: In the case of freezer temperature chart, the temperature range can be changed by pressing the up or down key when the F. Temp. on upper left is highlighted [Fig. 5]. The initial setting is between -40 °C and 0 °C and the range is changed by 10 °C step by pressing the up or down key.

<The chart of door operation logs (refrigerator and freezer)>

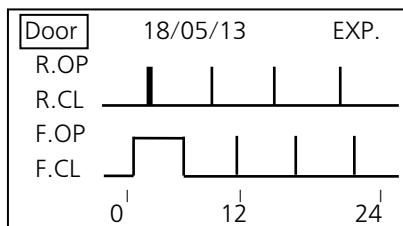

R.OP: refrigerator door opened
R.CL: refrigerator door closed
F.OP: freezer door opened
F.CL: freezer door closed

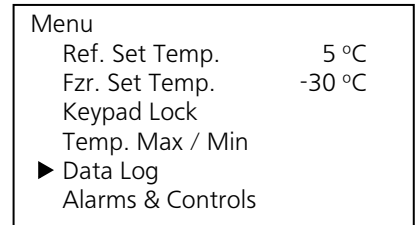

[Fig. 1]

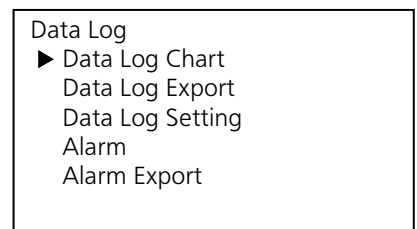

[Fig. 2]

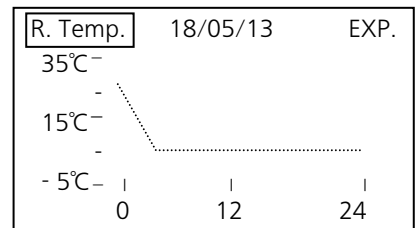

[Fig. 3]

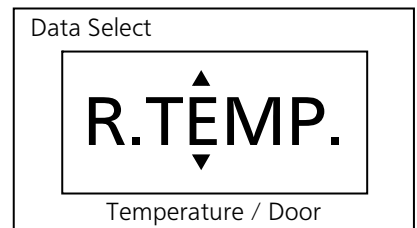

[Fig. 4]

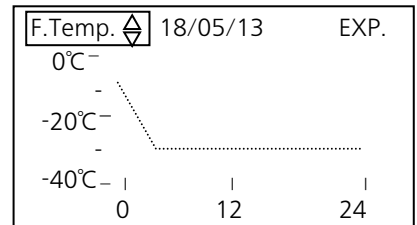

[Fig. 5]

- Press the right key with the data item (R. Temp., F. Temp. or Door) on upper left is highlighted [Fig. 5].
▶ The date is highlighted.

DISPLAY AND EXPORT OF DATA LOG

8. By pressing the up or down key, select the date of which data is displayed.

◇The date is advanced or got back by one day when the up or down key is pressed, and the chart of the data for the selected date is displayed.

Note: The Date Select screen is displayed [Fig. 6] when the enter key (ENTER) is pressed instead of the up or down key. Set the date by pressing the up or down key and right or left key.

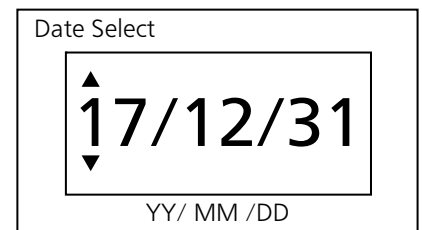

[Fig. 6]

9. Press the enter key (ENTER).

▶ The data for the selected date is displayed in chart.

<When exporting the data for the selected date to a USB memory device>

10. With the date is highlighted [Fig. 7], press the right key.

▶ EXP. on upper right is highlighted [Fig. 8].

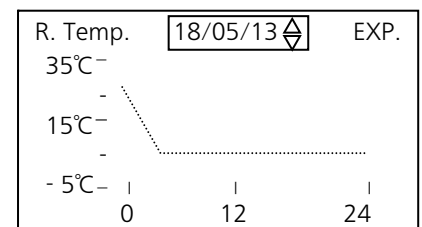

[Fig. 7]

12. Press the enter key (ENTER).

▶ The logs of chamber temperature (refrigerator and freezer) and door operation for the selected date are exported with CSV files. During exporting, Exporting.... is displayed.

Note: The following message may be indicated.

USB memory is disconnected; this means a USB memory device is not inserted.

USB memory is full; this means there is no data space in a USB memory device.

No Data: this means there is no data to be exported.

An error occurred: this means the exporting is resulted in failure.

▶ The chart screen is displayed by pressing the enter key (ENTER).

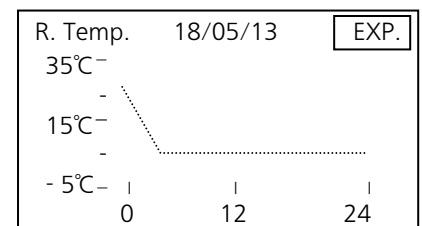

[Fig. 8]

13. Press any key on the control panel when the screen showing the completion of data exporting is displayed [Fig. 9].

▶ The chart screen is displayed.



[Fig. 9]

14. Remove the USB memory device from the USB port.

15. Press the menu key (MENU/HOME) to display the home screen.

◇The display returns to the home screen automatically when 90 seconds has passed without any key operation.

DISPLAY AND EXPORT OF DATA LOG

Export of temperature and door operation logs

All temperature logs (refrigerator and freezer) and door operation logs saved in a memory or log for a selected date (24 hours) can be exported to a USB memory device.

1. Insert a USB memory device to the USB port.
2. On the home screen, press the menu key (MENU/HOME).
 - ▶ The Menu screen is displayed.
3. By pressing the up or down key, move the cursor to the Data Log [Fig. 1] and then press the enter key (ENTER).
 - ▶ The Data Log screen is displayed.
4. By pressing the up or down key, move the cursor to the Data Log Export [Fig. 2] and then press the enter key (ENTER).
 - ▶ The Data Log Export screen is displayed [Fig. 3].
5. With the cursor on the 24 Hours [Fig. 3], press the enter key (ENTER) when the log for a specified date is exported.
 - ▶ The Date Select screen is displayed [Fig.4].
6. By pressing the up, down, right or left key, set a date of which log is exported, and then press the enter key (ENTER).
7. The log for the set date is exported to the USB memory device.

Note: Select All in the above procedure 5 and press the enter key (ENTER) when all memorized logs are exported.

8. "Export complete" is displayed when the export is finished. By pressing the up, down, right or left key, the Data Log Export screen is displayed.

9. Remove the USB memory device from the USB port.

10. Press the menu key (MENU/HOME) to display the home screen.
 - ◇ The display returns to the home screen automatically when 90 seconds has passed without any key operation.

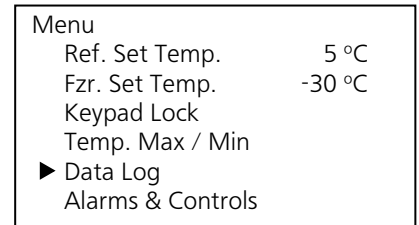

[Fig. 1]

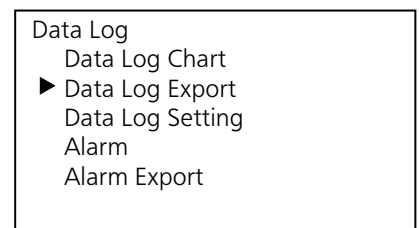

[Fig. 2]



[Fig. 3]

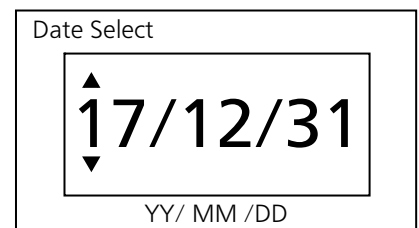

[Fig. 4]

DISPLAY AND EXPORT OF DATA LOG

Setting the log interval

The log interval for the chamber temperature (refrigerator and freezer) can be set.

- Setting range of log interval: between 1 minute and 15 minutes
- Initial setting (factory setting): 1 minute (log for approximately 3 months can be stored)

1. On the home screen, press the menu key (MENU/HOME).

▶ The Menu screen is displayed.

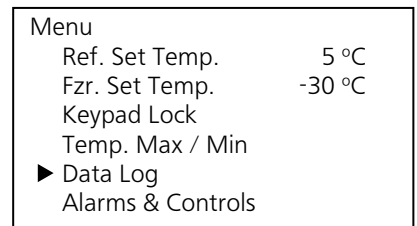

[Fig. 1]

2. By pressing the up or down key, move the cursor to the Data Log [Fig. 1] and then press the enter key (ENTER).

▶ The Data Log screen is displayed.

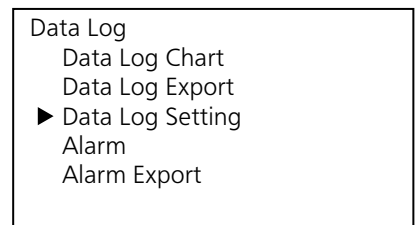

[Fig. 2]

3. By pressing the up or down key, move the cursor to the Data Log Setting [Fig. 2] and then press the enter key (ENTER).

▶ The Data Log Setting screen is displayed [Fig. 3].

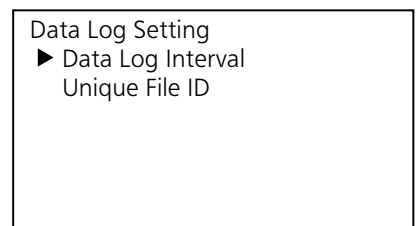

[Fig. 3]

4. With the cursor on the Data Log Interval [Fig. 3], press the enter key (ENTER).

▶ The Data Log Interval screen is displayed [Fig. 4].

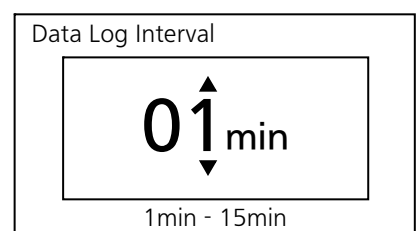

[Fig. 4]

5. By pressing the right or left key, select the digit to be changed and then change the figure by pressing the up or down key.

6. Press the enter key (ENTER).

▶ The setting is memorized and the screen is changed to the Data Log Setting screen.

7. Press the menu key (MENU/HOME) to display the home screen.

◇ The display returns to the home screen automatically when 90 seconds has passed without any key operation.

DISPLAY AND EXPORT OF DATA LOG

Setting the device ID

The unique device ID indicated on the file exported to a USB memory device (CSV file) can be set.

- Setting range of device ID: 6-digit number and alphabet (capital letter only)
- Initial setting (factory setting): 000000

1. On the home screen, press the menu key (MENU/HOME).

▶ The Menu screen is displayed.

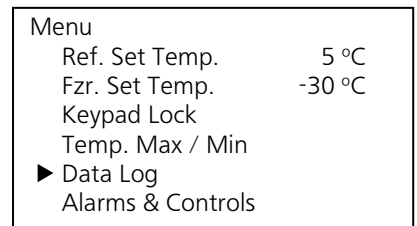

[Fig. 1]

2. By pressing the up or down key, move the cursor to the Data Log [Fig. 1] and then press the enter key (ENTER).

▶ The Data Log screen is displayed.



[Fig. 2]

3. By pressing the up or down key, move the cursor to the Data Log Setting [Fig. 2] and then press the enter key (ENTER).

▶ The Data Log Setting screen is displayed.

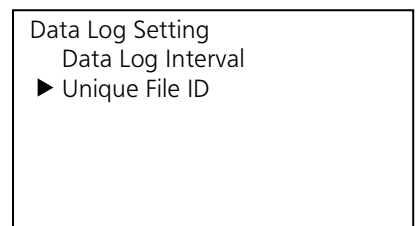

[Fig. 3]

4. By pressing the up or down key, move the cursor to the Unique File ID [Fig. 3] and then press the enter key (ENTER).

▶ The Unique File ID screen is displayed [Fig. 4].

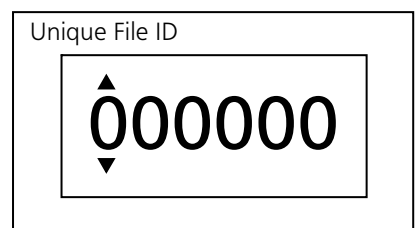

[Fig. 4]

5. By pressing the right or left key, select the digit to be changed and then change the figure or alphabet by pressing the up or down key.

6. Press the enter key (ENTER).

▶ The setting is memorized and the screen is changed to the Data Log Setting screen.

7. Press the menu key (MENU/HOME) to display the home screen.

◇ The display returns to the home screen automatically when 90 seconds has passed without any key operation.

DISPLAY OF ALARM LOG

The alarm log can be displayed on the screen. Following shows the format of the indication.

①	Alarm		
	18/03/05 12:00	W01	▲ ②
	Ref. SNSR Open		
	18/01/25 05:30	W03	
	Fzr. SNSR Open		
	18/01/01 08:45	W10	▼ ③
	Power Failure		

① Display area for alarm log

One alarm log is displayed in two lines and three alarm logs can be displayed on the screen. The upper line shows a date and time when an alarm detected, and an error code. The lower line shows an error message.

✧ For the details of error code and error message, refer to page 55.

② Up scroll mark

✧ By pressing the up key, the later alarm log is displayed when the up scroll mark is displayed.

③ Down scroll mark

✧ By pressing the down key, the previous alarm log is displayed when the down scroll mark is displayed.

1. On the home screen, press the menu key (MENU/HOME).

▶ The Menu screen is displayed.

Menu	
Ref. Set Temp.	5 °C
Fzr. Set Temp.	-30 °C
Keypad Lock	
Temp. Max / Min	
▶ Data Log	
Alarms & Controls	

[Fig. 1]

2. By pressing the up or down key, move the cursor to the Data Log [Fig. 1] and then press the enter key (ENTER).

▶ The Data Log screen is displayed [Fig. 2].

Data Log	
Data Log Chart	
Data Log Export	
Data Log Setting	
▶ Alarm	
Alarm Export	

[Fig. 2]

3. By pressing the up or down key, move the cursor to the Alarm [Fig. 2] and then press the enter key (ENTER).

▶ The Alarm screen is displayed [Fig. 3].

4. Press the menu key (MENU/HOME) to display the home screen.

✧ The display returns to the home screen automatically when 90 seconds has passed without any key operation.

Alarm		
18/03/05 12:00	W01	▲
Ref. SNSR Open		
18/01/25 05:30	W03	
Fzr. SNSR Open		
18/01/01 08:50	W10	▼
Power Failure		

[Fig.3]

EXPORT OF ALARM LOG

The alarm log for the selected date or all alarm logs saved in the memory can be exported to a USB memory device in CSV file.

1. Insert a USB memory device to the USB port.
 2. On the home screen, press the menu key (MENU/HOME).
 - ▶ The Menu screen is displayed.
 3. By pressing the up or down key, move the cursor to the Data Log [Fig. 1] and then press the enter key (ENTER).
 - ▶ The Data Log screen is displayed.
 4. By pressing the up or down key, move the cursor to the Alarm Export [Fig. 2] and then press the enter key (ENTER).
 - ▶ The Alarm Export screen is displayed [Fig. 3].
 5. With the cursor on the 24 Hours [Fig. 3], press the enter key (ENTER) when the alarm log for a specified date is exported.
 - ▶ The Date Select screen is displayed [Fig.4].
 6. By pressing the up, down, right or left key, set a date of which alarm log is exported, and then press the enter key (ENTER).
 7. The alarm log for the set date is exported to the USB memory device.
- Note: Select All in the above procedure 5 and press the enter key (ENTER) when all memorized alarm logs are exported.
8. "Export complete" is displayed when the export is finished. By pressing the up, down, right or left key, the Alarm Export screen is displayed.
 9. Remove the USB memory device from the USB port.
 10. Press the menu key (MENU/HOME) to display the home screen.
 - ◇ The display returns to the home screen automatically when 90 seconds has passed without any key operation.

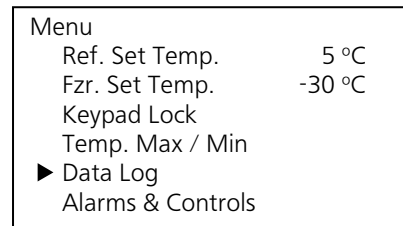

[Fig. 1]

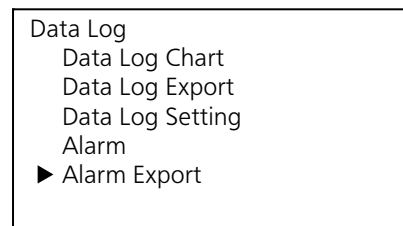

[Fig. 2]



[Fig. 3]

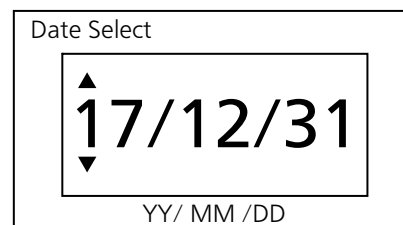

[Fig. 4]

SETTING THE SELECTABLE PARAMETERS

Selectable parameters

The setting of some parameters (including the alarm setting) can be changed. Following shows the selectable parameters. Refer to the following pages for the details.

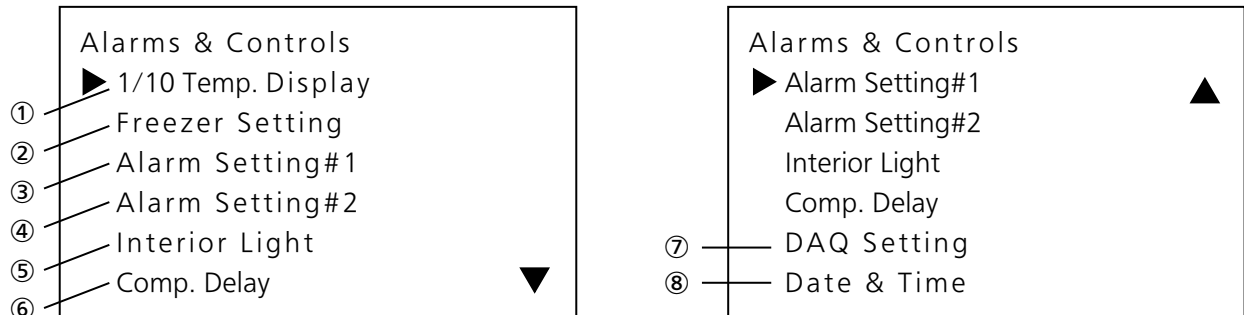

①1/10 Temp. Display

The temperature display format on the home screen is selectable; integer display or decimal display.

②Freezer Setting

The setting is changed when the freezer operation is stopped for defrosting. Also, ON/OFF of freezer alarm is selectable.

③Alarm Setting #1

The selectable parameters; high temperature alarm and low temperature alarm of refrigerator, high temperature alarm and low temperature alarm of freezer.

④Alarm Setting #2

The selectable parameters; delay of door alarm buzzer, buzzer suspended period, buzzer volume, remote alarm.

⑤Interior Light

The setting of interior light; linked with the door operation, always ON or always OFF.

⑥Comp. Delay

The delay time of compressor start after recovery form the power failure is selectable.

⑦DAQ Setting

The selectable parameters; device ID for data acquisition, communication speed of data acquisition, remote control.

⑧Date & Time

The selectable parameters; setting of date and time, and format of date/time indication "YY/MM/DD" or "DD/MM/YY)

SETTING THE SELECTABLE PARAMETERS

Setting the temperature display

1. On the home screen, press the menu key (MENU/HOME).
▶ The Menu screen is displayed.
2. By pressing the up or down key, move the cursor to the Alarms & Controls [Fig. 1] and then press the enter key (ENTER).
▶ The Alarms & Controls screen is displayed [Fig. 2].
3. With the cursor on the 1/10 Temp. Display [Fig. 2], press the enter key (ENTER).
▶ The 1/10 Temp. Display screen is displayed [Fig.3].
4. The setting is changed to the integer display (00°C) or decimal display (00.0°C) when the up or down key is pressed.
5. Press the enter key (ENTER).
▶ The setting is memorized and the screen is changed to the Alarms & Controls screen.
6. Press the menu key (MENU/HOME) to display the home screen.
✧ The display returns to the home screen automatically when 90 seconds has passed without any key operation.

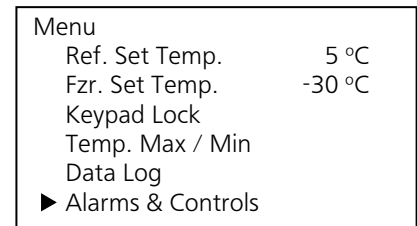

[Fig. 1]

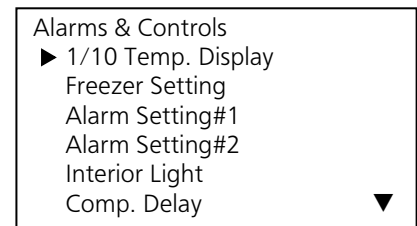

[Fig. 2]

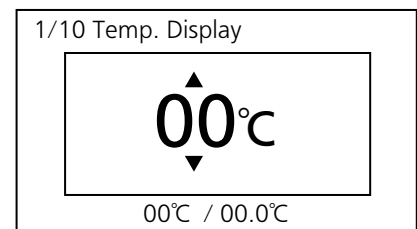

[Fig. 3]

SETTING THE SELECTABLE PARAMETERS

Setting the freezer defrosting

Stop the freezer operation according to the procedure below when removing the frost in the freezer chamber.

◇ Refer to page 57 for the freezer defrosting.

1. On the home screen, press the menu key (MENU/HOME).

▶ The Menu screen is displayed.

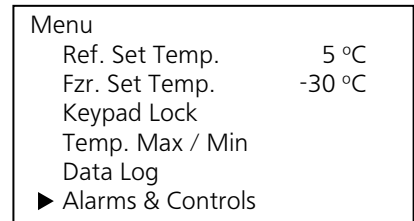

[Fig. 1]

2. By pressing the up or down key, move the cursor to the Alarms & Controls [Fig. 1] and then press the enter key (ENTER).

▶ The Alarms & Controls screen is displayed.

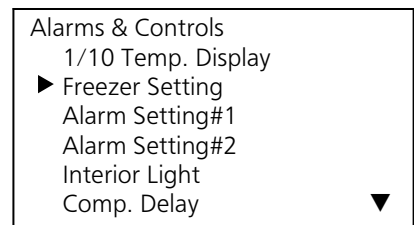

[Fig. 2]

3. By pressing the up or down key, move the cursor to the Freezer Setting [Fig. 2] and then press the enter key (ENTER).

▶ The Freezer Setting screen is displayed [Fig. 3].

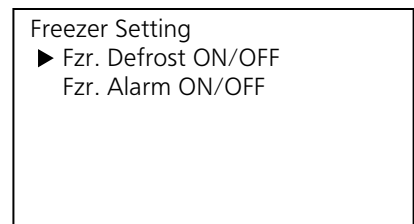

[Fig. 3]

4. With the cursor on the Fzr. Defrost ON/OFF [Fig. 3], press the enter key (ENTER).

▶ The Fzr. Defrost ON/OFF screen is displayed, and the current setting (OFF) is displayed [Fig. 4].

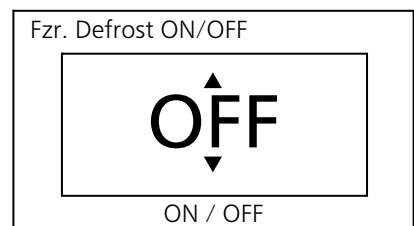

[Fig. 4]

5. By pressing the up or down key, change the setting to ON.

◇ The setting is changed to ON or OFF when the up or down key is pressed.

6. Press the enter key (ENTER).

▶ The setting is memorized and the screen is changed to the Freezer Setting screen. At the same time, the freezer operation stops (defrosting by operation stop).

Note: When starting the freezer operation, change the setting to ON in the above procedure 5 and then press the enter key (ENTER).

7. Press the menu key (MENU/HOME) to display the home screen.

▶ DEF is displayed on the freezer temperature screen.

◇ The display returns to the home screen automatically when 90 seconds has passed without any key operation.

SETTING THE SELECTABLE PARAMETERS

Setting the freezer alarm buzzer

The high-temperature alarm will be kept for long period when freezing the ice packs. In this case, silence the buzzer by the following procedure.

1. On the home screen, press the menu key (MENU/HOME).

▶ The Menu screen is displayed.

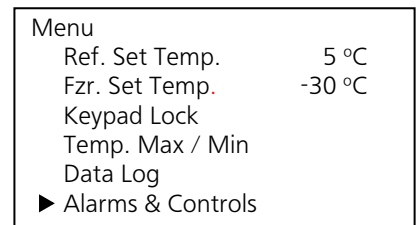

[Fig. 1]

2. By pressing the up or down key, move the cursor to the Alarms & Controls [Fig. 1] and then press the enter key (ENTER).

▶ The Alarms & Controls screen is displayed.

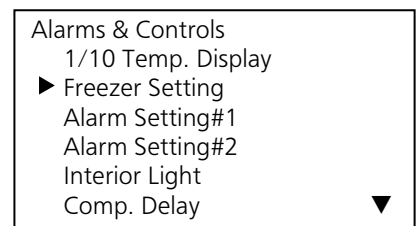

[Fig. 2]

3. By pressing the up or down key, move the cursor to the Freezer Setting [Fig. 2] and then press the enter key (ENTER).

▶ The Freezer Setting screen is displayed.

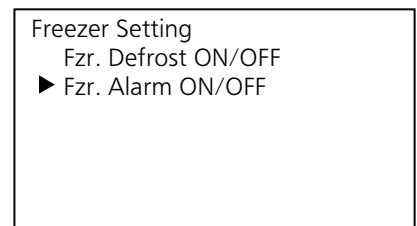

[Fig. 3]

4. By pressing the up or down key, move the cursor to the Fzr. Alarm ON/OFF [Fig. 3] and then press the enter key (ENTER).

▶ The Fzr. Alarm ON/OFF screen is displayed, and the current setting (ON) is displayed [Fig. 4].

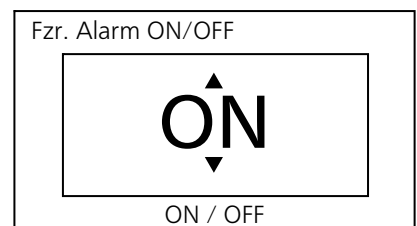

[Fig. 4]

5. By pressing the up or down key, change the setting to OFF.

◇ The setting is changed to ON or OFF when the up or down key is pressed.

Note: When the setting is OFF, freezer alarm buzzer is inactive. The alarm status is indicated by the blinking of red LED lamp only.

6. Press the enter key (ENTER).

▶ The setting is memorized and the screen is changed to the Freezer Setting screen.

7. Press the menu key (MENU/HOME) to display the home screen.

▶ NOFA is displayed on the freezer temperature screen.

◇ The display returns to the home screen automatically when 90 seconds has passed without any key operation.

SETTING THE SELECTABLE PARAMETERS

Setting the high-temp. alarm of refrigerator

An abnormality (chamber temperature rise) is indicated by the blinking of red LED lamp and the chamber temperature display and the buzzer sounding (15 minutes after blinking) if the chamber temperature exceeds the set value of the high-temperature alarm. Always set the high-temperature alarm to protect stored items from damage resulting from an increase in temperature.

- Setting range for high-temperature alarm:
between 2 °C and 14 °C higher than the chamber set temperature
- Initial setting (factory setting): 5 °C higher than the chamber set temperature

1. On the home screen, press the menu key (MENU/HOME).

▶ The Menu screen is displayed.

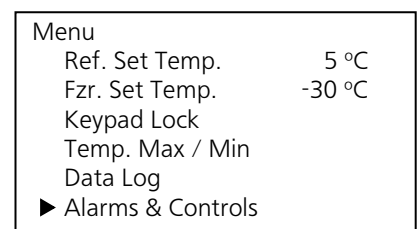

[Fig. 1]

2. By pressing the up or down key, move the cursor to the Alarms & Controls [Fig. 1] and then press the enter key (ENTER).

▶ The Alarms & Controls screen is displayed.

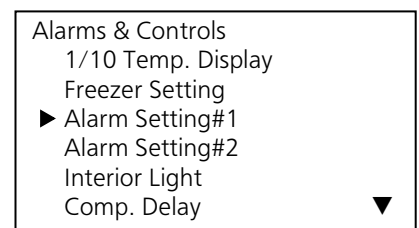

[Fig. 2]

3. By pressing the up or down key, move the cursor to the Alarm Setting #1 [Fig. 2] and then press the enter key (ENTER).

▶ The Alarm Setting #1 screen is displayed.

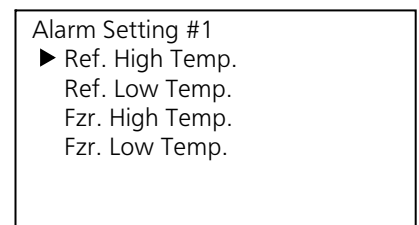

[Fig. 3]

4. With the cursor on the Ref. High Temp. [Fig. 3], press the enter key (ENTER).

▶ The Ref. High Temp. screen is displayed, and the current setting (05) is displayed [Fig. 4].

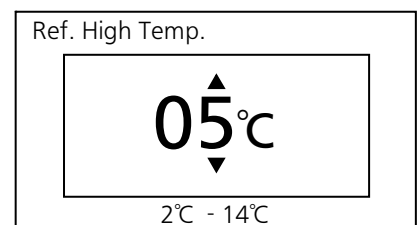

[Fig. 4]

5. By pressing the right or left key, select the digit to be changed and then change the figure by pressing the up or down key.

6. Press the enter key (ENTER).

▶ The setting is memorized and the screen is changed to the Alarm Setting #1 screen.

7. Press the menu key (MENU/HOME) to display the home screen.

◇ The display returns to the home screen automatically when 90 seconds has passed without any key operation.

SETTING THE SELECTABLE PARAMETERS

Setting the low-temp. alarm of refrigerator

An abnormality (chamber temperature drop) is indicated by the blinking of red LED lamp and the chamber temperature display and the buzzer sounding (15 minutes after blinking) if the chamber temperature falls below the set value of low-temperature alarm. Always set the low-temperature alarm to protect stored items from damage resulting from a drop in temperature.

- Setting range for low-temperature alarm:
between 14 °C and 2 °C lower than the chamber set temperature
- Initial setting (factory setting): 5 °C lower than the chamber set temperature

1. On the home screen, press the menu key (MENU/HOME).

▶ The Menu screen is displayed.

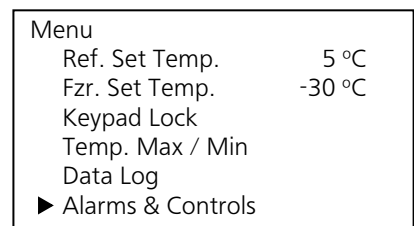

[Fig. 1]

2. By pressing the up or down key, move the cursor to the Alarms & Controls [Fig. 1] and then press the enter key (ENTER).

▶ The Alarms & Controls screen is displayed.

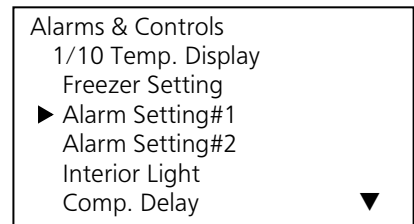

[Fig. 2]

3. By pressing the up or down key, move the cursor to the Alarm Setting #1 [Fig. 2] and then press the enter key (ENTER).

▶ The Alarm Setting #1 screen is displayed.

4. By pressing the up or down key, move the cursor to the Ref. Low Temp. [Fig. 3] and then press the enter key (ENTER).

▶ The Ref. Low Temp. screen is displayed, and the current setting (-05) is displayed [Fig. 4].

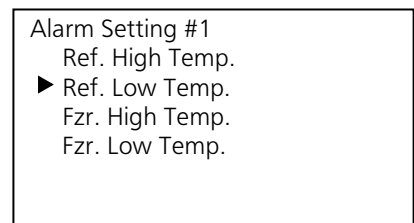

[Fig. 3]

5. By pressing the right or left key, select the digit to be changed and then change the figure by pressing the up or down key.

6. Press the enter key (ENTER).

▶ The setting is memorized and the screen is changed to the Alarm Setting #1 screen.

7. Press the menu key (MENU/HOME) to display the home screen.

◇ The display returns to the home screen automatically when 90 seconds has passed without any key operation.

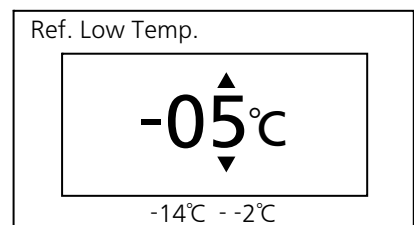

[Fig. 4]

SETTING THE SELECTABLE PARAMETERS

Setting the high-temp. alarm of freezer

An abnormality (chamber temperature rise) is indicated by the blinking of red LED lamp and the chamber temperature display and the buzzer sounding (15 minutes after blinking) if the chamber temperature exceeds the set value of the high-temperature alarm. Always set the high-temperature alarm to protect stored items from damage resulting from an increase in temperature.

- Setting range for high-temperature alarm:
between 5 °C and 15 °C higher than the chamber set temperature
- Initial setting (factory setting): 10 °C higher than the chamber set temperature

1. On the home screen, press the menu key (MENU/HOME).

▶ The Menu screen is displayed.

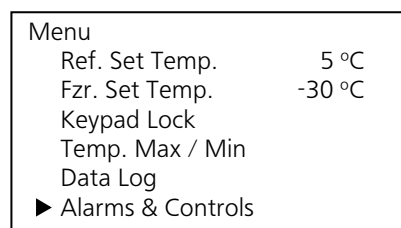

[Fig. 1]

2. By pressing the up or down key, move the cursor to the Alarms & Controls [Fig. 1] and then press the enter key (ENTER).

▶ The Alarms & Controls screen is displayed.

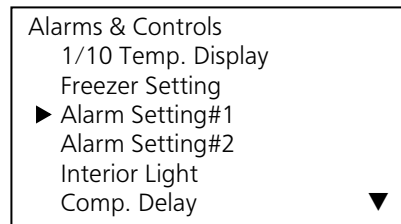

[Fig. 2]

3. By pressing the up or down key, move the cursor to the Alarm Setting #1 [Fig. 2] and then press the enter key (ENTER).

▶ The Alarm Setting #1 screen is displayed.

4. By pressing the up or down key, move the cursor to the Fzr. High Temp. [Fig. 3] and then press the enter key (ENTER).

▶ The Fzr. High Temp. screen is displayed, and the current setting (10) is displayed [Fig. 4].

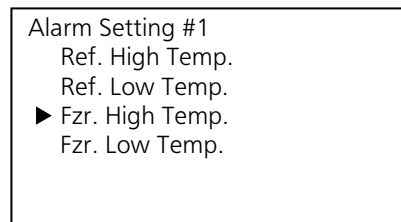

[Fig. 3]

5. By pressing the right or left key, select the digit to be changed and then change the figure by pressing the up or down key.

6. Press the enter key (ENTER).

▶ The setting is memorized and the screen is changed to the Alarm Setting #1 screen.

7. Press the menu key (MENU/HOME) to display the home screen.

◇ The display returns to the home screen automatically when 90 seconds has passed without any key operation.

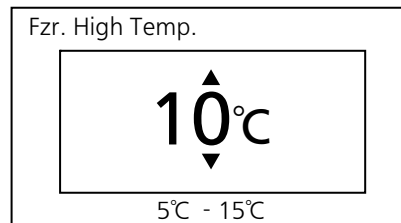

[Fig. 4]

SETTING THE SELECTABLE PARAMETERS

Setting the low-temp. alarm of freezer

An abnormality (chamber temperature drop) is indicated by the blinking of red LED lamp and the chamber temperature display and the buzzer sounding (15 minutes after blinking) if the chamber temperature falls below the set value of low-temperature alarm. Always set the low-temperature alarm to protect stored items from damage resulting from a drop in temperature.

- Setting range for low-temperature alarm:
between 15 °C and 5 °C lower than the chamber set temperature
- Initial setting (factory setting): 10 °C lower than the chamber set temperature

1. On the home screen, press the menu key (MENU/HOME).

▶ The Menu screen is displayed.

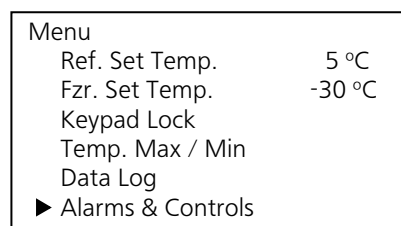

[Fig. 1]

2. By pressing the up or down key, move the cursor to the Alarms & Controls [Fig. 1] and then press the enter key (ENTER).

▶ The Alarms & Controls screen is displayed.

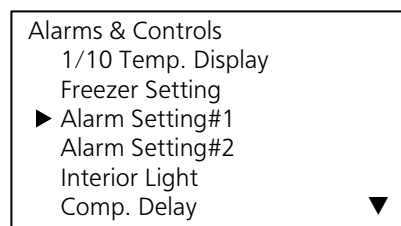

[Fig. 2]

3. By pressing the up or down key, move the cursor to the Alarm Setting #1 [Fig. 2] and then press the enter key (ENTER).

▶ The Alarm Setting #1 screen is displayed.

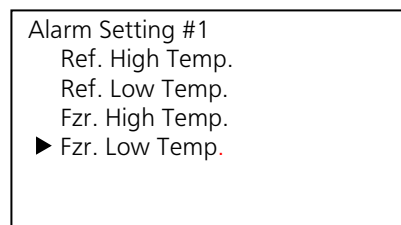

[Fig. 3]

4. By pressing the up or down key, move the cursor to the Fzr. Low Temp. [Fig. 3] and then press the enter key (ENTER).

▶ The Fzr. Low Temp. screen is displayed, and the current setting (-10) is displayed [Fig. 4].

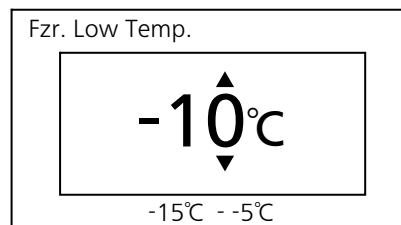

[Fig. 4]

5. By pressing the right or left key, select the digit to be changed and then change the figure by pressing the up or down key.

6. Press the enter key (ENTER).

▶ The setting is memorized and the screen is changed to the Alarm Setting #1 screen.

7. Press the menu key (MENU/HOME) to display the home screen.

◇ The display returns to the home screen automatically when 90 seconds has passed without any key operation.

SETTING THE SELECTABLE PARAMETERS

Setting the door buzzer delay

The red LED lamp blinks when the door is opened, and the buzzer sounds (after a delay) to indicate that the door is open.

The delay time (between the blinking of the red LED lamp and the activation of the buzzer) can be changed. Set an appropriate delay time according to the condition of use to prevent the rise of chamber temperature occurring as a result of the door being left open for too long.

- Setting range of delay time: between 0 and 15 minutes (0 means no delay)
- Initial setting (factory setting): 2 minutes

1. On the home screen, press the menu key (MENU/HOME).

▶ The Menu screen is displayed.

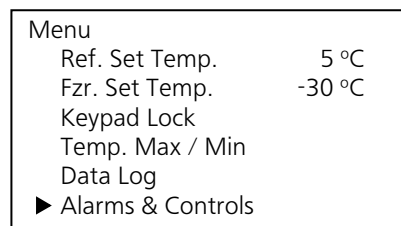

[Fig. 1]

2. By pressing the up or down key, move the cursor to the Alarms & Controls [Fig. 1] and then press the enter key (ENTER).

▶ The Alarms & Controls screen is displayed.

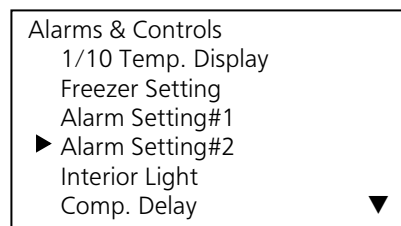

[Fig. 2]

3. By pressing the up or down key, move the cursor to the Alarm Setting #2 [Fig. 2] and then press the enter key (ENTER).

▶ The Alarm Setting #2 screen is displayed.

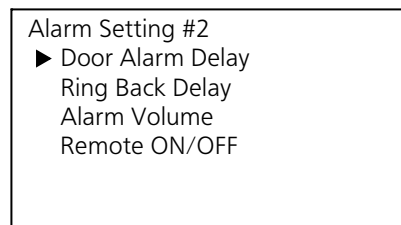

[Fig. 3]

4. With the cursor on the Door Alarm Delay [Fig. 3], press the enter key (ENTER).

▶ The Door Alarm Delay screen is displayed, and the current setting (02) is displayed [Fig. 4].

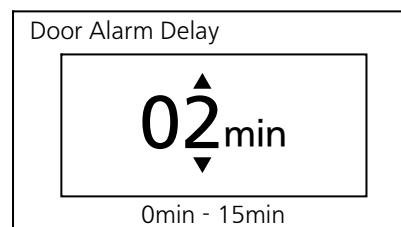

[Fig. 4]

5. By pressing the right or left key, select the digit to be changed and then change the figure by pressing the up or down key.

6. Press the enter key (ENTER).

▶ The setting is memorized and the screen is changed to the Alarm Setting #2 screen.

7. Press the menu key (MENU/HOME) to display the home screen.

◇ The display returns to the home screen automatically when 90 seconds has passed without any key operation.

SETTING THE SELECTABLE PARAMETERS

Setting the buzzer suspended period

An abnormality is indicated again by the buzzer sounding after a certain period has elapsed (the buzzer recovery time) if the alarm mode continues even after the buzzer has already been silenced by pressing the buzzer stop key (BUZZER STOP). Always set the “buzzer suspended period” to avoid incorrect recognition of alarm mode.

- Setting range of buzzer suspended period: between 0 and 60 minutes in 10-minute intervals
- Initial setting (factory setting): 30 minutes

◇The buzzer does not sound again when the setting is 0 (but if the other alarm is occurred, the buzzer sounds). The setting should be between 10 and 60 to ensure the safety of stored items.

1. On the home screen, press the menu key (MENU/HOME).

▶ The Menu screen is displayed.

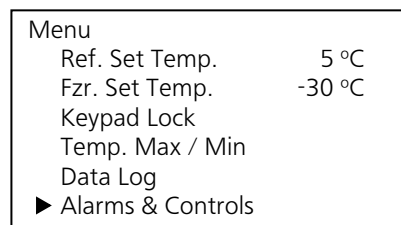

[Fig. 1]

2. By pressing the up or down key, move the cursor to the Alarms & Controls [Fig. 1] and then press the enter key (ENTER).

▶ The Alarms & Controls screen is displayed.

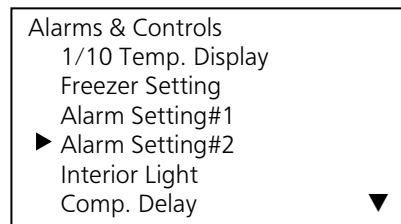

[Fig. 2]

3. By pressing the up or down key, move the cursor to the Alarm Setting #2 [Fig. 2] and then press the enter key (ENTER).

▶ The Alarm Setting #2 screen is displayed.

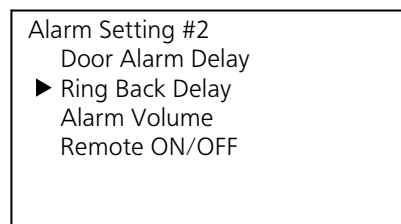

[Fig. 3]

4. By pressing the up or down key, move the cursor to the Ring Back Delay [Fig. 3] and then press the enter key (ENTER).

▶ The Ring Back Delay screen is displayed, and the current setting (30) is displayed [Fig. 4].

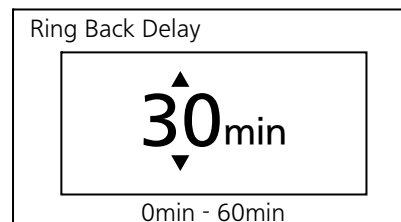

[Fig. 4]

5. By pressing the up or down key, change the figure.

6. Press the enter key (ENTER).

▶ The setting is memorized and the screen is changed to the Alarm Setting #2 screen.

7. Press the menu key (MENU/HOME) to display the home screen.

◇The display returns to the home screen automatically when 90 seconds has passed without any key operation.

SETTING THE SELECTABLE PARAMETERS

Setting the buzzer volume

The buzzer volume is selectable. Select the appropriate volume taking into consideration of the environment of installation site.

- Setting range of buzzer volume: Low (small = standard), High (loud)
- Initial setting (factory setting): Low (small = standard)

1. On the home screen, press the menu key (MENU/HOME).

▶ The Menu screen is displayed.

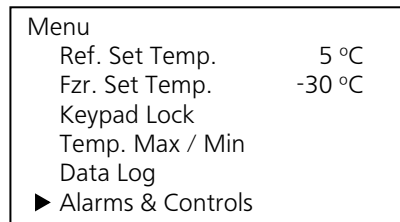

[Fig. 1]

2. By pressing the up or down key, move the cursor to the Alarms & Controls [Fig. 1] and then press the enter key (ENTER).

▶ The Alarms & Controls screen is displayed.

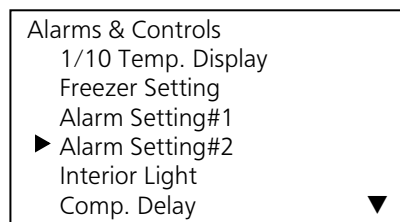

[Fig. 2]

3. By pressing the up or down key, move the cursor to the Alarm Setting #2 [Fig. 2] and then press the enter key (ENTER).

▶ The Alarm Setting #2 screen is displayed.

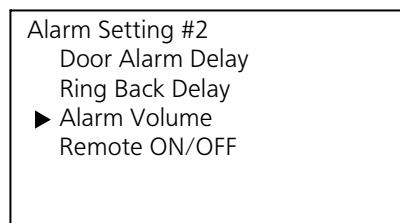

[Fig. 3]

4. By pressing the up or down key, move the cursor to the Alarm Volume [Fig. 3] and then press the enter key (ENTER).

▶ The Alarm Volume screen is displayed, and the current setting (LOW) is displayed [Fig. 4].

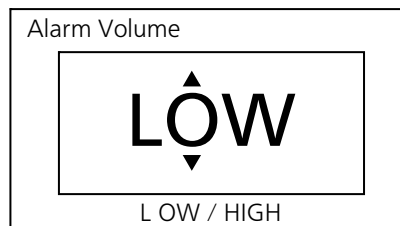

[Fig. 4]

5. By pressing the up or down key, change the setting to HIGH.

◇ The setting is changed to LOW or HIGH when the up or down key is pressed.

6. Press the enter key (ENTER).

▶ The setting is memorized and the screen is changed to the Alarm Setting #2 screen.

7. Press the menu key (MENU/HOME) to display the home screen.

◇ The display returns to the home screen automatically when 90 seconds has passed without any key operation.

SETTING THE SELECTABLE PARAMETERS

Setting the remote alarm

The alarm of this unit can be informed at a remote location from this unit by connecting the external alarm device (commercial goods) to the remote alarm terminals. It is selectable that the operation of the external alarm device is linked with the buzzer or not.

In the case of link: The alarm of the external device is cancelled when by buzzer stop key (BUZZER STOP) is pressed during buzzer operation. But the alarm is not cancelled in the case of power failure alarm.

In the case of no-link: The alarm of the external device is not cancelled when by buzzer stop key (BUZZER STOP) is pressed during buzzer operation.

- Setting range of remote alarm: OFF (no-link), ON (link)
- Initial setting (factory setting): OFF (no-link)

1. On the home screen, press the menu key (MENU/HOME).

▶ The Menu screen is displayed.

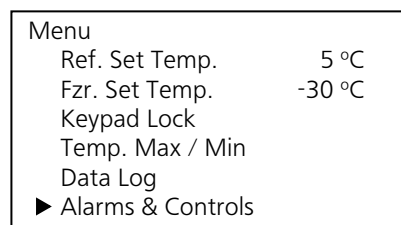

[Fig. 1]

2. By pressing the up or down key, move the cursor to the Alarms & Controls [Fig. 1] and then press the enter key (ENTER).

▶ The Alarms & Controls screen is displayed.

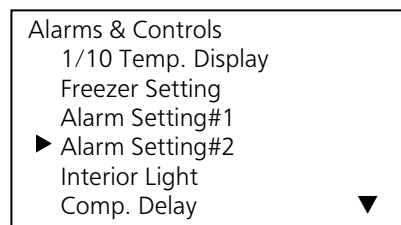

[Fig. 2]

3. By pressing the up or down key, move the cursor to the Alarm Setting #2 [Fig. 2] and then press the enter key (ENTER).

▶ The Alarm Setting #2 screen is displayed.

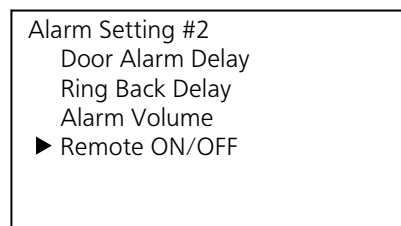

[Fig. 3]

4. By pressing the up or down key, move the cursor to the Remote ON/OFF [Fig. 3] and then press the enter key (ENTER).

▶ The Remote ON/OFF screen is displayed, and the current setting (OFF) is displayed [Fig. 4].

5. By pressing the up or down key, change the setting to ON.

◇ The setting is changed to ON or OFF when the up or down key is pressed.

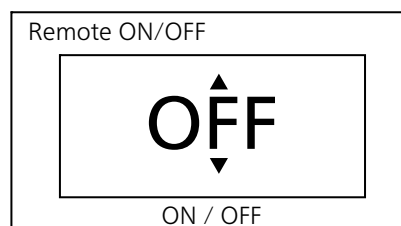

[Fig. 4]

6. Press the enter key (ENTER).

▶ The setting is memorized and the screen is changed to the Alarm Setting #2 screen.

7. Press the menu key (MENU/HOME) to display the home screen.

◇ The display returns to the home screen automatically when 90 seconds has passed without any key operation.

SETTING THE SELECTABLE PARAMETERS

Setting the interior light

The lighting condition of the interior light can be selectable among three; link with door operation, always ON, always OFF.

- Setting range of interior light: link with door operation (AUTO), always ON (ON), always OFF (OFF)
- Initial setting (factory setting): link with door operation (AUTO)

1. On the home screen, press the menu key (MENU/HOME).

▶ The Menu screen is displayed.

2. By pressing the up or down key, move the cursor to the Alarms & Controls [Fig. 1] and then press the enter key (ENTER).

▶ The Alarms & Controls screen is displayed.

3. By pressing the up or down key, move the cursor to the Interior Light [Fig. 2] and then press the enter key (ENTER).

▶ The Interior Light screen is displayed, and the current setting (AUTO) is displayed [Fig. 3].

4. By pressing the up or down key, change the setting.

✧ The setting is changed to OFF, ON or AUTO when the up or down key is pressed.

5. Press the enter key (ENTER).

▶ The setting is memorized and the screen is changed to the Alarms & Controls screen.

6. Press the menu key (MENU/HOME) to display the home screen.

✧ The display returns to the home screen automatically when 90 seconds has passed without any key operation.

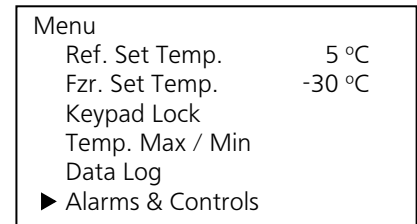

[Fig. 1]

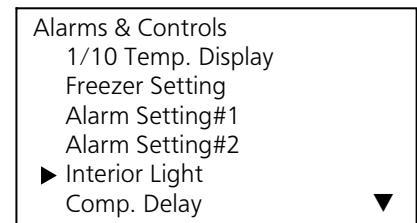

[Fig. 2]

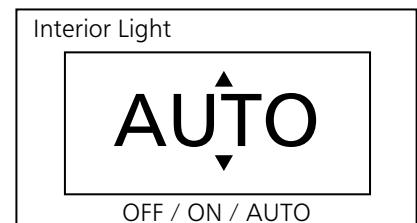

[Fig. 3]

SETTING THE SELECTABLE PARAMETERS

Setting the compressor delay

The delay time before the compressor starts can be changed to reduce the load on the power line and to facilitate the start-up (reset) of the refrigerator during recovery after power failure.

<Important>

Change the delay time only when the multiple devices are connected to one power source.

- Setting range of delay time: between 3 minutes and 15 minutes
- Initial setting (factory setting): 3 minutes

1. On the home screen, press the menu key (MENU/HOME).

▶ The Menu screen is displayed.

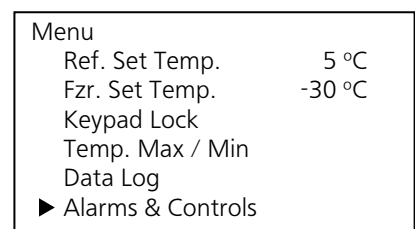

[Fig. 1]

2. By pressing the up or down key, move the cursor to the Alarms & Controls [Fig. 1] and then press the enter key (ENTER).

▶ The Alarms & Controls screen is displayed.

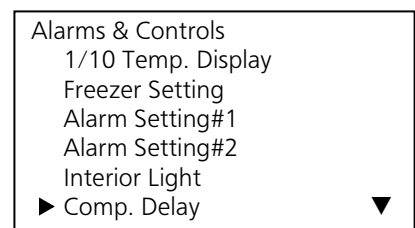

[Fig. 2]

3. By pressing the up or down key, move the cursor to the Comp. Delay [Fig. 2] and then press the enter key (ENTER).

▶ The Comp. Delay screen is displayed, and the current setting (03) is displayed [Fig. 3].

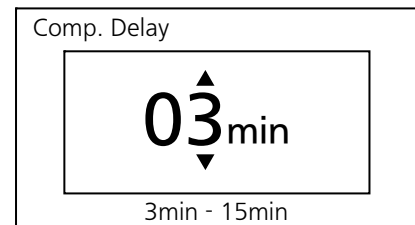

[Fig. 3]

4. By pressing the right or left key, select the digit to be changed and then change the figure by pressing the up or down key.

5. Press the enter key (ENTER).

▶ The setting is memorized and the screen is changed to the Alarms & Controls screen.

6. Press the menu key (MENU/HOME) to display the home screen.

◇ The display returns to the home screen automatically when 90 seconds has passed without any key operation.

SETTING THE SELECTABLE PARAMETERS

Setting the device ID for data acquisition

Set a device ID for data acquisition when using the optional data acquisition system (MTR-5000).

- Setting range of device ID: between 0 and 255
- Initial setting (factory setting): 000

1. On the home screen, press the menu key (MENU/HOME).

▶ The Menu screen is displayed.

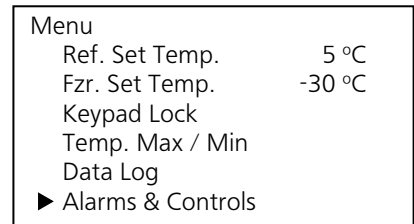

[Fig. 1]

2. By pressing the up or down key, move the cursor to the Alarms & Controls [Fig. 1] and then press the enter key (ENTER).

▶ The Alarms & Controls screen is displayed.

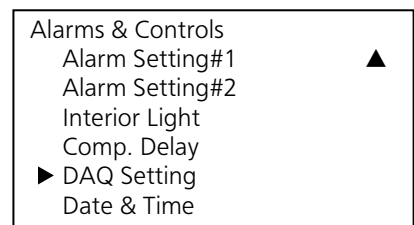

[Fig. 2]

3. By pressing the up or down key, move the cursor to the DAQ Setting [Fig. 2] and then press the enter key (ENTER).

▶ The DAQ Setting screen is displayed.

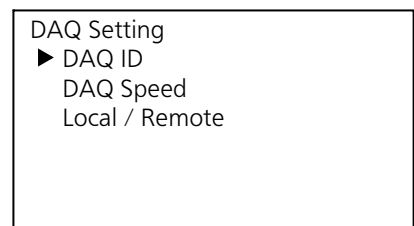

[Fig. 3]

4. With the cursor on the DAQ ID [Fig. 3], press the enter key (ENTER).

▶ The DAQ ID screen is displayed, and the current setting (000) is displayed [Fig. 4].

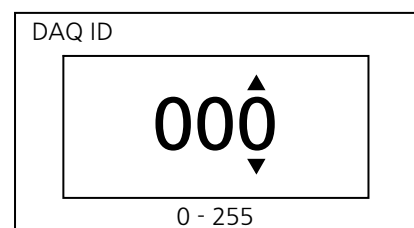

[Fig. 4]

5. By pressing the right or left key, select the digit to be changed and then change the figure by pressing the up or down key.

6. Press the enter key (ENTER).

▶ The setting is memorized and the screen is changed to the DAQ Setting screen.

7. Press the menu key (MENU/HOME) to display the home screen.

◇ The display returns to the home screen automatically when 90 seconds has passed without any key operation.

SETTING THE SELECTABLE PARAMETERS

Setting the speed for data acquisition

Set a communicating speed for data acquisition when using the optional data acquisition system (MTR-5000).

- Setting range of communicating speed: 2400 bps, 4800 bps, 9600 bps
- Initial setting (factory setting): 2400 bps

1. On the home screen, press the menu key (MENU/HOME).

▶ The Menu screen is displayed.

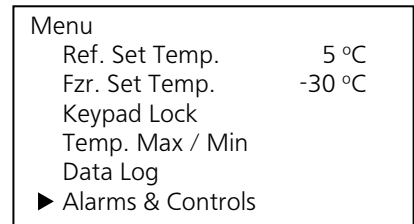

[Fig. 1]

2. By pressing the up or down key, move the cursor to the Alarms & Controls [Fig. 1] and then press the enter key (ENTER).

▶ The Alarms & Controls screen is displayed.

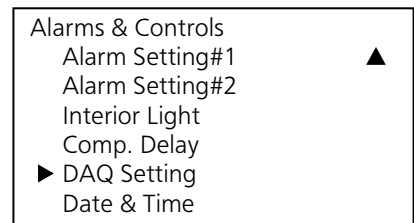

[Fig. 2]

3. By pressing the up or down key, move the cursor to the DAQ Setting [Fig. 2] and then press the enter key (ENTER).

▶ The DAQ Setting screen is displayed.

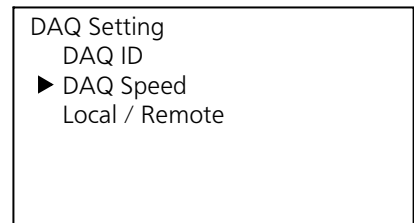

[Fig. 3]

4. By pressing the up or down key, move the cursor to the DAQ Speed [Fig. 3] and then press the enter key (ENTER).

▶ The DAQ Speed screen is displayed, and the current setting (2400) is displayed [Fig. 4].

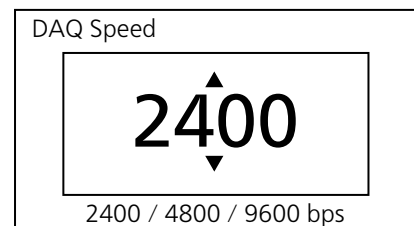

[Fig. 4]

5. By pressing the up or down key, change the setting.

◇ The setting is changed to 2400, 4800 or 9600 when the up or down key is pressed.

6. Press the enter key (ENTER).

▶ The setting is memorized and the screen is changed to the DAQ Setting screen.

7. Press the menu key (MENU/HOME) to display the home screen.

◇ The display returns to the home screen automatically when 90 seconds has passed without any key operation.

SETTING THE SELECTABLE PARAMETERS

Setting the remote control

By the remote control, the setting of chamber temperature can be changed through the software of the optional data acquisition system (MTR-5000).

■ Setting range of remote control:

LOCAL (change of the chamber set temperature remotely is unable) or,

REMOTE (change of the chamber set temperature remotely is enable)

■ Initial setting (factory setting): LOCAL (change of the chamber set temperature remotely is unable)

1. On the home screen, press the menu key (MENU/HOME).

▶ The Menu screen is displayed.

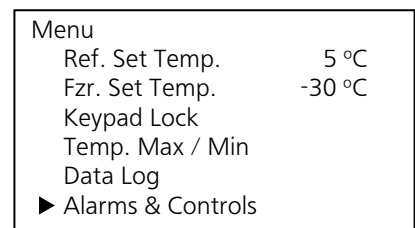

[Fig. 1]

2. By pressing the up or down key, move the cursor to the Alarms & Controls [Fig. 1] and then press the enter key (ENTER).

▶ The Alarms & Controls screen is displayed.

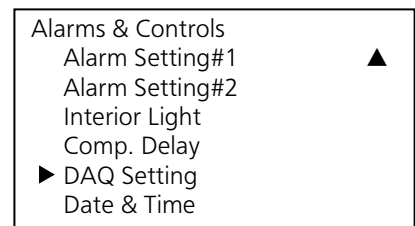

[Fig. 2]

3. By pressing the up or down key, move the cursor to the DAQ Setting [Fig. 2] and then press the enter key (ENTER).

▶ The DAQ Setting screen is displayed.

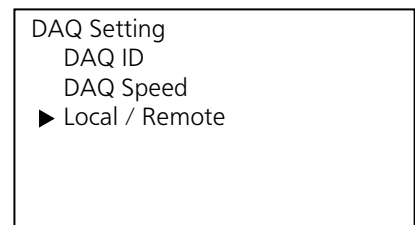

[Fig. 3]

4. By pressing the up or down key, move the cursor to the Local / Remote [Fig. 3] and then press the enter key (ENTER).

▶ The Local / Remote screen is displayed, and the current setting (LOCAL) is displayed [Fig. 4].

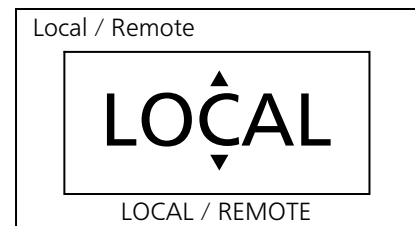

[Fig. 4]

5. By pressing the up or down key, change the setting to REMOTE.

◇ The setting is changed to LOCAL or REMOTE when the up or down key is pressed.

6. Press the enter key (ENTER).

▶ The setting is memorized and the screen is changed to the DAQ Setting screen.

7. Press the menu key (MENU/HOME) to display the home screen.

◇ The display returns to the home screen automatically when 90 seconds has passed without any key operation.

Note: In the case of REMOTE setting, R is displayed upper right on the Ref. Set Temp. screen and Fzr. Set Temp. screen. This means the change of the chamber (refrigerator and freezer) set temperature is unable.

SETTING THE SELECTABLE PARAMETERS

Setting the date display (format)

The format of date display is selectable between two types.

- Setting range: year / month / day (YY/MM/DD), or day / month / year (DD/MM/YY)
- Initial setting (factory setting): year / month / day (YY/MM/DD)

1. On the home screen, press the menu key (MENU/HOME).

▶ The Menu screen is displayed.

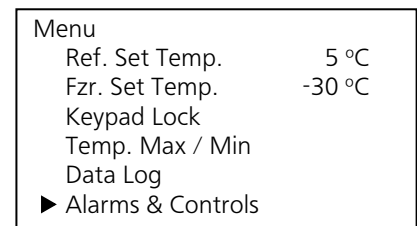

[Fig. 1]

2. By pressing the up or down key, move the cursor to the Alarms & Controls [Fig. 1] and then press the enter key (ENTER).

▶ The Alarms & Controls screen is displayed.

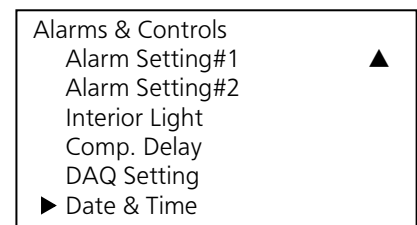

[Fig. 2]

3. By pressing the up or down key, move the cursor to the Date & Time [Fig. 2] and then press the enter key (ENTER).

▶ The Date & Time screen is displayed [Fig. 3].

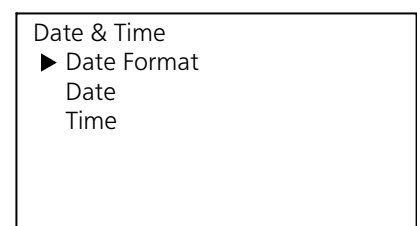

[Fig. 3]

4. With the cursor on the Date Format [Fig. 3], press the enter key (ENTER).

▶ The Date Format screen is displayed, and the current setting (YY/MM/DD) is displayed [Fig. 4].

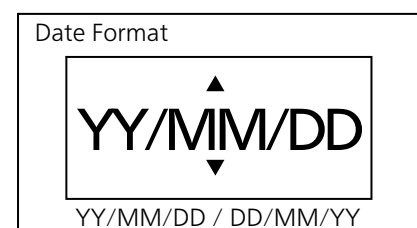

[Fig. 4]

5. By pressing the up or down key, change the setting to DD/MM/YY.

◇ The setting is changed to YY/MM/DD, DD/MM/YY when the up or down key is pressed.

6. Press the enter key (ENTER).

▶ The setting is memorized and the screen is changed to the Date & Time screen.

7. Press the menu key (MENU/HOME) to display the home screen.

◇ The display returns to the home screen automatically when 90 seconds has passed without any key operation.

SETTING THE SELECTABLE PARAMETERS

Setting the date

1. On the home screen, press the menu key (MENU/HOME).

▶ The Menu screen is displayed.

2. By pressing the up or down key, move the cursor to the Alarms & Controls [Fig. 1] and then press the enter key (ENTER).

▶ The Alarms & Controls screen is displayed.

3. By pressing the up or down key, move the cursor to the Date & Time [Fig. 2] and then press the enter key (ENTER).

▶ The Date & Time screen is displayed.

4. By pressing the up or down key, move the cursor to the Date [Fig. 3] and then press the enter key (ENTER).

▶ The Date screen is displayed, and the current date (YY/MM/DD) is displayed [Fig. 4].

5. By pressing the right or left key, select the digit to be changed and then change the figure by pressing the up or down key.

The figure can be changed same as above when the date format is DD/MM/YY.

6. Press the enter key (ENTER).

▶ The setting is memorized and the screen is changed to the Date & Time screen.

7. Press the menu key (MENU/HOME) to display the home screen.

◇ The display returns to the home screen automatically when 90 seconds has passed without any key operation.

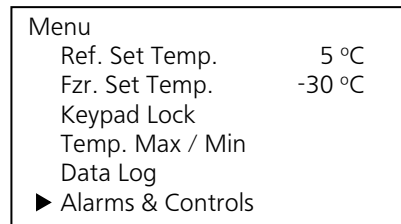

[Fig. 1]

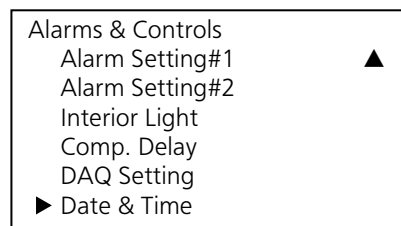

[Fig. 2]

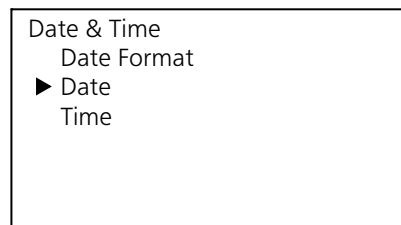

[Fig. 3]

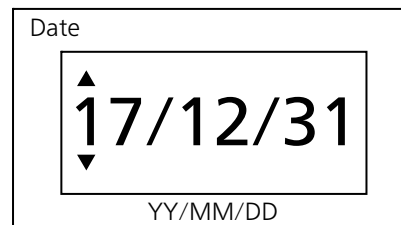

[Fig. 4]

SETTING THE SELECTABLE PARAMETERS

Setting the time

It is recommended to adjust the time periodically since the deviation of about one minutes per a month may be occurred.

1. On the home screen, press the menu key (MENU/HOME).

▶ The Menu screen is displayed.

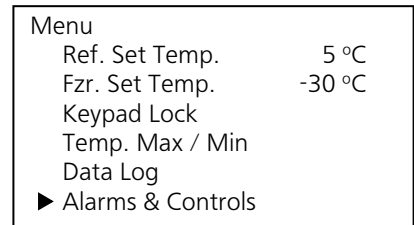

[Fig. 1]

2. By pressing the up or down key, move the cursor to the Alarms & Controls [Fig. 1] and then press the enter key (ENTER).

▶ The Alarms & Controls screen is displayed.

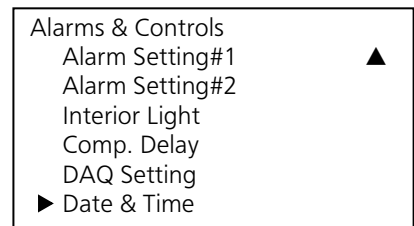

[Fig. 2]

3. By pressing the up or down key, move the cursor to the Date & Time [Fig. 2] and then press the enter key (ENTER).

▶ The Date & Time screen is displayed.

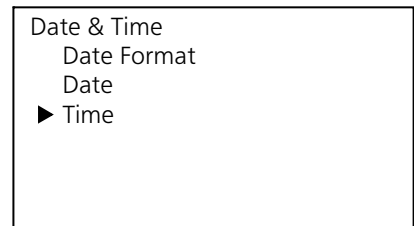

[Fig. 3]

4. By pressing the up or down key, move the cursor to the Time [Fig. 3] and then press the enter key (ENTER).

▶ The Time screen is displayed, and the current time is displayed [Fig. 4].

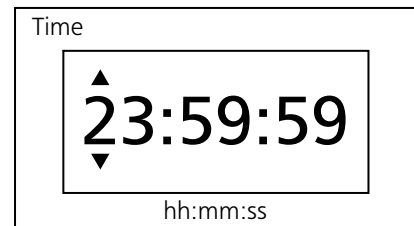

[Fig. 4]

5. By pressing the right or left key, select the digit to be changed and then change the figure by pressing the up or down key.

◇ hh:mm:ss means the hour, minute and second can be set in 2-digit.

hh = hour (between 00 and 23), mm = minute (between 00 and 59),
ss = second (between 00 and 59)

6. Press the enter key (ENTER).

▶ The setting is memorized and the screen is changed to the Date & Time screen.

7. Press the menu key (MENU/HOME) to display the home screen.

◇ The display returns to the home screen automatically when 90 seconds has passed without any key operation.

REMOTE ALARM TERMINAL

The alarm is relayed to a remote location when a remote alarm device (commercially available) is connected to the remote alarm terminal. Installation of a remote alarm device is recommended when the unit is installed in an unattended location so that the operator of the unit is notified of the alarm.

◇Contact our representative or agent to arrange the installation of a remote alarm device.

- Location of remote alarm terminal: right bottom (inside)

- Allowable contact capacity: DC 30 V, 2 A

◇It is recommended to use standard signal and interface cables with a maximum length of 30 meters.

<Important>

The remote alarm terminal will be in alarm mode when the power supply cord is unplugged or the power switch is turned off because this will be interpreted as a power failure.

ALARMS AND SELF-DIAGNOSIS

This unit has the alarm functions and self-diagnosis functions listed below.

An error code and error message are displayed on the temperature display when an alarm or self-diagnosis goes off.

Contact our sales representative or agent if the alarm mode continues, since the failure of the unit is supposed.

◇ Before calling for service, take some precautions to prevent the stored items (for example by transferring the items to another freezer).

The first letter of the error code means:

W: Warning - The cooling performance is significantly reduced.

A: Alarm - The cooling performance may decline and the temperature of the chamber may rise.

S: Status - There is a possibility of failure other than the cooling performance. Or the status of the unit is notified.

Error code	Error message	Alarm content	LED indicator	Buzzer	Remote alarm	Alarm log
W01	Ref.SNSR Open	Disconnection of refrigerator thermal sensor	Blinking of red lamp	Intermittent tone	Alarm mode	Logged
W02	Ref.SNSR Short	Short-circuit of refrigerator thermal sensor	Blinking of red lamp	Intermittent tone	Alarm mode	Logged
W03	Fzr.SNSR Open	Disconnection of freezer thermal sensor	Blinking of red lamp	Intermittent tone	Alarm mode	Logged
W04	Fzr.SNSR Short	Short-circuit of freezer thermal sensor	Blinking of red lamp	Intermittent tone	Alarm mode	Logged
W05	Freeze Warning	Alarm of refrigerator; equal or lower than 0 °C	Blinking of red lamp	Intermittent tone	Alarm mode	Logged
W06	Ref.Temp.High	High-temp. alarm of refrigerator	Blinking of red lamp	Intermittent tone	Alarm mode	Logged
W07	Ref.Temp.Low	Low-temp. alarm of refrigerator	Blinking of red lamp	Intermittent tone	Alarm mode	Logged
W08	Fzr.Temp.High	High-temp. alarm of freezer	Blinking of red lamp	Intermittent tone	Alarm mode	Logged
W09	Fzr.Temp.Low	Low-temp. alarm of freezer	Blinking of red lamp	Intermittent tone	Alarm mode	Logged
W10	Power Failure	Power failure alarm	Blinking of red lamp	Intermittent tone	Alarm mode	Logged
W11	Inverter Err.	Inverter abnormal	Blinking of red lamp	Intermittent tone	Alarm mode	Logged
W12	INT Fan Lock	Chamber fan lock	Blinking of red lamp	Intermittent tone	Alarm mode	Logged
W13	Comp. Fan Lock	Compressor fan lock	Blinking of red lamp	Intermittent tone	Alarm mode	Logged
A01	Door Open	Door alarm	Blinking of red lamp	Intermittent tone	---	---
A02	Def.SNSR Open	Disconnection of defrost sensor	Blinking of red lamp	Intermittent tone	---	Logged
A03	Def.SNSR Short	Short-circuit of defrost sensor	Blinking of red lamp	Intermittent tone	---	Logged
A06	Ref.Temp.High	Delayed status of high-temp. alarm of refrigerator	Blinking of red lamp	---	---	---
A07	Ref.Temp.Low	Delayed status of low-temp. alarm of refrigerator	Blinking of red lamp	---	---	---
A08	Fzr.Temp.High	Delayed status of high-temp. alarm of freezer	Blinking of red lamp	---	---	---
A09	Fzr.Temp.Low	Delayed status of low-temp. alarm of freezer	Blinking of red lamp	---	---	---
S01	Door Delay ON	Delayed status of door alarm	Blinking of red lamp	---	---	---
S02	Battery Err.	Battery installation error	Blinking of red lamp	Intermittent tone	---	---
S03	Replace Battery	The time for battery replacement	---	---	---	---
S04	COMM Err.	Communication error	Blinking of red lamp	---	---	Logged

ROUTINE MAINTENANCE

Cleaning of exterior, interior, and accessories

Use a dry cloth to wipe off small amounts of dirt on the outside and inside of the unit and all accessories. If the outside panels are dirty, clean them with a diluted neutral dishwashing detergent.

Wipe off the condensation on the glass (MPR-N45FH) or exterior of the cabinet with a dry soft cloth.

◇Undiluted detergent can damage the plastic components. For the dilution, refer to the instruction of the detergent.

◇After the cleaning with the diluted detergent, always wipe it off with a wet cloth. Then wipe off the cabinet or accessories with a dry cloth.

<Important>

Never pour water onto or into the unit. This may cause electric shock or failure.

Do not use a brush, an acid, a thinner, laundry soap, a powder detergent, or boiling water for cleaning. These may cause damage to painted surfaces or cause perishing of plastic and rubber components. Moreover, do not wipe plastic and rubber components with a volatile material.

DEFROSTING

Defrosting the refrigerator

The following 2 types of defrosting methods is provided for the refrigerator. Both of them are controlled automatically.

■ Cycle defrosting

The refrigerator temperature is kept stable by ON/OFF operation of the compressor. When the compressor is OFF (stopped), the frost on the evaporator is melted by the heater. This defrosting never influences to the refrigerator temperature.

■ Defrosting by defrost sensor

The cycle defrosting may not be sufficient to remove the frost on the evaporator when the ambient temperature is high, the door is opened frequently, or heavy moist items are stored in the refrigerator. In this case, the defrosting operation is started automatically when the defrost sensor detects the frost.

During the defrosting, DEF is displayed on the temperature display of home screen.

After completion of defrosting, DEF display is disappeared and the refrigerator returns to the normal operation.

<Important>

During the defrosting, the refrigerator temperature reaches around 10 °C temporary.

<Reference>

Too much frost is accumulated on the evaporator when the refrigerator is running under high temperature and humidity condition. For example, the defrosting operation is started once a week when the refrigerator is running with 2 °C setting at 30 °C, 80 % R.H.

Defrosting the freezer

The freezer has no automatic defrosting system. Stop the freezer operation and remove the frost when the frost is accumulated in the freezer (when the defrost indicator is covered with frost).

Following shows the procedure for defrosting.

1. Move all storage items in the freezer to other freezer.
2. Stop the freezer operation according to the procedure on page 36.
3. After the frost in the freezer is melted, take out the drain hose (see the figure). Set a pan under the drain hose. Remove the drain hose cap and drain port cap in the freezer to drain the water.
4. Wipe off the freezer with a dry cloth. Replace the caps to the drain hose and store the drain hose. Then replace the cap to the drain port in the freezer.
5. Start the freezer operation according to the procedure on page 36.
6. Check that the freezer temperature reaches the set temperature and replace the storage items.

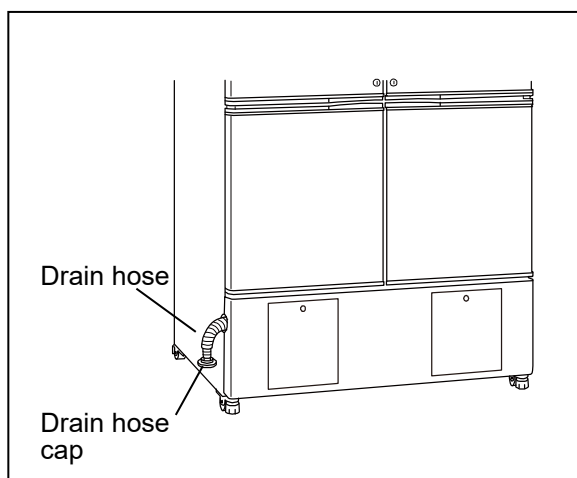

TROUBLESHOOTING

If the unit malfunctions, check out the following before calling for service.

<Attention>

If the malfunction is not resolved after checking the following items or if the malfunction is not shown in the table below, contact our sales representative or agent.

Malfunction	Check/Remedy
If nothing operates even when plugged in	<ul style="list-style-type: none"> <input type="checkbox"/> The unit is not connected to the power supply properly. <input type="checkbox"/> The capacity and voltage of power supply is not sufficient. <input type="checkbox"/> The power switch is OFF. <input type="checkbox"/> There is a power failure. <input type="checkbox"/> The circuit breaker on the supply circuit is activated.
The alarm is activated at start-up	<ul style="list-style-type: none"> ◇ The alarm status is kept until the chamber temperature reaches the set temperature.
The alarm is activated during operation	<ul style="list-style-type: none"> <input type="checkbox"/> The door (refrigerator or freezer) was kept opened for a long time. <input type="checkbox"/> The door (refrigerator or freezer) is opened. <input type="checkbox"/> An error code is displayed on the temperature display [page 55]. <p>→ Contact our sales representative or agent.</p>
Noisy	<ul style="list-style-type: none"> <input type="checkbox"/> The floor is not sturdy. <input type="checkbox"/> The installation site is not level. <input type="checkbox"/> The refrigerator is tilted. <input type="checkbox"/> The cabinet contact the surrounding wall.
When chamber does not get cold enough	<ul style="list-style-type: none"> <input type="checkbox"/> The door is frequently opened. <input type="checkbox"/> The unit is in direct sunlight. <input type="checkbox"/> The ventilation around the unit is blocked. <input type="checkbox"/> There is a nearby heat source. <input type="checkbox"/> The ambient temperature is too high. <p>→ The allowable ambient temperature is between -5 °C and 35 °C.</p> <ul style="list-style-type: none"> <input type="checkbox"/> The stored items is too much. <input type="checkbox"/> The air exhaust vent is blocked up with storage items. <input type="checkbox"/> The refrigerator is under defrosting [page 57]. <input type="checkbox"/> The setting of freezer defrost is ON [page 36]. <input type="checkbox"/> The access port is not covered. <p>→ The access port should be covered with the insulation and rubber caps when no use.</p> <ul style="list-style-type: none"> <input type="checkbox"/> The magnetic gasket is damaged. <p>→ If it is damaged, contact our sales representative or agent for replacement.</p> <ul style="list-style-type: none"> <input type="checkbox"/> Any foreign substance is located between magnetic gaskets. <input type="checkbox"/> There is a nearby an electric product which emits an electromagnetic wave.

Note:

Keep an electric product which emits an electromagnetic wave away from this unit. A noise from an electromagnetic wave may cause malfunction to this unit.

DISPOSAL OF UNIT

WARNING



If the unit is to be stored unused in an unsupervised area for an extended period **ensure that children do not have access and doors cannot be closed completely.**

The disposal of the unit should be accomplished by appropriate personnel. Always remove doors to prevent accidents such as suffocation.



Flammable and explosive product. The unit contains flammable refrigerant. When repairing or recycling, only trained service personnel will repair and follow the procedure below.

- Well ventilate the room to prevent refrigerant accumulation.
- Keep fire away when the refrigerant is contained in the product.
- Do not damage or break the pipework.



*Label indication is obliged to comply with Taiwanese battery regulation.

Decontamination of unit

Before disposal of unit with biohazardous danger, decontaminate the unit to the extent possible by the user.

DISPOSAL OF UNIT

Disposal of Old Equipment and Batteries

Only for European Union and countries with recycling systems



These symbols on the products, packaging, and/or accompanying documents mean that used electrical and electronic products and batteries must not be mixed with general household waste.

For proper treatment, recovery and recycling of old products and used batteries, please take them to applicable collection points in accordance with your national legislation.

By disposing of them correctly, you will help to save valuable resources and prevent any potential negative effects on human health and the environment.

For more information about collection and recycling, please contact your local municipality.

Penalties may be applicable for incorrect disposal of this waste, in accordance with national legislation.

Note for the battery symbol (bottom symbol):

This symbol might be used in combination with a chemical symbol. In this case it complies with the requirement set by the Directive for the chemical involved.

Likvidácia opotrebovaných zariadení a batérií

Len pre Európsku úniu a krajiny so systémom recyklácie



Tieto symboly uvádzané na výrobkoch, balení a/alebo v sprievodnej dokumentácii informujú o tom, že opotrebované elektrické a elektronické výrobky a batérie sa nesmú likvidovať ako bežný domový odpad. V záujme zabezpečenia správneho spôsobu likvidácie, spracovania a recyklácie odovzdajte opotrebované výrobky a batérie na špecializovanom zbernom mieste v súlade s platnou legislatívou.

Správnym spôsobom likvidácie týchto výrobkov a batérií prispějete k zachovaniu cenných zdrojov a predídete prípadným negatívnym dopadom na ľudské zdravie a životné prostredie.

Podrobnejšie informácie o zbere a recyklácii vám poskytnú miestne úrady.

Pri nesprávnej likvidácii tohto druhu odpadu môžu byť v súlade s platnou legislatívou udelené pokuty.

Poznámka týkajúca sa symbolu batérie (spodný symbol):

Tento symbol môže byť použitý spolu so symbolom chemickej značky. V takom prípade vyhovuje požiadavke stanovenej Smernicou týkajúcou sa príslušnej chemikálie.

Изхвърляне на излезли от употреба електрически и електронни уреди и батерии

Само за Европейския съюз и страните със системи за рециклиране



Този символ върху продуктите, опаковката и/или придружаващите документи означава, че изразходваните електрически и електронни продукти и батериите не бива да се изхвърлят в общите битови отпадъци.

Моля, предавайте старите продукти и изхабените батерии за обработка, преработка и рециклиране на компетентните пунктове за събиране на отпадъци съгласно законовите разпоредби.

Като изхвърляте тези продукти и батериите правилно, Вие помагате за запазване на ценни ресурси и за избягване на евентуално вредните влияния върху човешкото здраве и околната среда.

За повече информация относно събирането и рециклирането се обърнете към Вашето предприятие на място, предлагащо услуги във връзка с изхвърлянето на отпадъците.

Съгласно разпоредбите в страната за неправилно изхвърляне на тези отпадъци могат да бъдат наложени парични глоби.

Указание за символа батерия (символ долу):

Този символ може да е изобразен в комбинация с химически символ. В този случай това се прави поради изискванията на директивите, издадени за съответния химикал.

Tájékoztató felhasználók számára az elhasználtott készülékek, szárazelemek és akkumulátorok begyűjtéséről és ártalmatlanításáról.

Csak az Európai Unió és olyan országok részére, amelyek begyűjtő rendszerekkel rendelkeznek



A termékeken, a csomagoláson és/vagy a kísérő dokumentumokon szereplő szimbólumok azt jelentik, hogy az elhasználtott elektromos és elektronikus termékeket, szárazelemeket és akkumulátorokat tilos az általános háztartási hulladékkal keverni.

Az elhasználtott készülékek, szárazelemek és akkumulátorok megfelelő kezelése, hasznosítása és újrafelhasználása céljából, kérjük, hogy a helyi törvényeknek, megfelelően juttassa el azokat a kijelölt gyűjtőhelyekre.

E termékek, szárazelemek és akkumulátorok előírás szerű ártalmatlanításával Ön hozzájárul az értékes erőforrások megővéséhez, és megakadályozza az emberi egészség és a környezet károsodását.

Amennyiben a begyűjtéssel és újrafelhasználással kapcsolatban további kérdése lenne, kérjük, érdeklődjön a helyi önkormányzatnál.

E hulladékok szabálytalan elhelyezését a nemzeti jogszabályok büntethetik.

Megjegyzés a szárazelem- és akkumulátor-szimbólummal kapcsolatban (alsó szimbólumpélda):

Ezek a szimbólumok kémiai szimbólummal együtt alkalmazhatók. Ebben az esetben teljesíti az EU irányelvnek vegyi anyagra vonatkozó követelményét.

Pozbywanie się zużytych urządzeń elektrycznych i elektronicznych oraz baterii.

Dotyczy wyłącznie obszaru Unii Europejskiej oraz krajów posiadających systemy zbiórki i recyklingu.



Niniejsze symbole umieszczane na produktach, opakowaniach i/lub w dokumentacji towarzyszącej oznaczają, że nie wolno mieszać zużytych urządzeń elektrycznych i elektronicznych oraz baterii z innymi odpadami domowymi/komunalnymi.

W celu zapewnienia właściwego przetwarzania, utylizacji oraz recyklingu zużytych urządzeń elektrycznych i elektronicznych oraz zużytych baterii, należy oddawać je do wyznaczonych punktów gromadzenia odpadów zgodnie z przepisami prawa krajowego.

Poprzez prawidłowe pozbywanie się zużytych urządzeń elektrycznych i elektronicznych oraz zużytych baterii pomagasz oszczędzać cenne zasoby naturalne oraz zapobiegać potencjalnemu negatywnemu wpływowi na zdrowie człowieka oraz na stan środowiska naturalnego.

W celu uzyskania informacji o zbiórce oraz recyklingu zużytych urządzeń elektrycznych i elektronicznych oraz baterii prosimy o kontakt z władzami lokalnymi.

Za niewłaściwe pozbywanie się tych odpadów mogą grozić kary przewidziane przepisami prawa krajowego.

Dotyczy symbolu baterii (symbol poniżej):

Ten symbol może występować wraz z symbolem pierwiastka chemicznego. W takim przypadku wymagania Dyrektywy w sprawie określonego środka chemicznego są spełnione.

Pomembna informacija za pravilno odstranjevanje izrabljene opreme in baterij

Samo za države EU in države, kjer imajo vzpostavljene sistem recikliranja odpadnih snovi



Simboli na samem izdelku, embalaži ali spremljajočih dokumentih pomenijo, da po koncu življenjske dobe aparata, z njim ni dovoljeno ravnati kot z drugimi gospodinjstskimi odpadki.

Vaša dolžnost je, da izrabljeno opremo ali napravo ter baterijske vložke predate v odstranjevanje na posebna zbirna mesta za ločeno zbiranje odpadkov v okviru vaše lokalne skupnosti oziroma zastopniku, ki opravlja dejavnost prevzemanja odpadne električne in elektronske opreme.

S tem, ko jih pravilno odstranite (recikliranje in sortiranje nevarnih odpadkov) varujete naše življensko okolje ter preprečujete negativni vpliv na naravo okrog nas, na naše življensko pomembne vire in vode.

Za dodatne informacije o zbiranju in recikliranju, prosim kontaktirajte vašo lokalno skupnost.

Nepravilno odstranjevanje nevarnih in izrabljenih snovi ter naprav je lahko kaznivo dejanje.

Obvestilo za baterijski simbol (spodnji simbol):

Ta simbol se uporablja v kombinaciji s kemičnim simbolom. V takšnem primeru odgovarja zahtevi, ki jo določa direktiva za dotično kemikalijo.

DISPOSAL OF UNIT

Likvidace použitých zařízení a baterií
Jen pro státy Evropské unie a země s fungujícím systémem recyklace a zpracování odpadu.



Tyto symboly na výrobcích, jejich obalech a v doprovodné dokumentaci upozorňují na to, že se použité elektrické a elektronické zařízení, včetně baterií, nesmějí likvidovat jako běžný komunální odpad.

Aby byla zajištěna správná likvidace a recyklace použitých výrobků a baterií, odevzdávejte je v souladu s národní legislativou na příslušných sběrných místech.

Správnou likvidací přispíváte k úspoře cenných přírodních zdrojů a předejete možným negativním dopadům na lidské zdraví a životní prostředí.

O další podrobnosti o sběru a recyklaci odpadu požádejte místní úřady.

Při nesprávné likvidaci tohoto druhu odpadu se vystavujete postihu podle národní legislativy.

Poznámka k symbolu baterie (značka pod symbolem):
 Tento symbol může být použitý v kombinaci s chemickou značkou. Takový případ je souladu s požadavky směrnice pro chemické látky.



Vanhojen laitteiden ja paristojen hävittäminen
Vain EU-jäsenmaille ja kierrätysjärjestelmää käyttäville maille



Tämä symboli tuotteissa, pakkauksessa ja/tai asiakirjoissa tarkoittaa, että käytettyjä sähköllä toimivia ja elektronisia tuotteita ei saa laittaa yleisiin talousjätteisiin.

Johda vanhat tuotteet ja käytetyt paristot käsittelyä, uusiointia tai kierrätystä varten vastaaviin keräyspisteisiin laissa annettujen määräysten mukaisesti.

Hävittämällä tuotteet asiaankuuluvasti, autat samalla suojaamaan arvokkaita luonnonvaroja ja estämään mahdollisia negatiivisia vaikutuksia ihmiseen ja luontoon.

Lisätietoa keräämisestä ja kierrätyksestä saa paikalliselta jätehuollosta vastuulliselta viranomaiselta. Maiden lainsäädännön mukaisesti tämän jätteen määrätystenvastaisesta hävittämisestä voidaan antaa sakkorangaistuksia.

Huomautus paristosymbolista (symboli alhaalla):
 Tämä symboli voidaan näyttää jonkin kemiallisen symbolin yhteydessä. Siinä tapauksessa se perustuu vastaaviin direktiiveihin, jotka on annettu kyseessä olevalle kemikaalille.



Eski Ekipman ve Bataryaların Tasfiyesi
Sadece Avrupa Birliği ve geri dönüşüm sistemleri olan ülkeler için



Ürünlerin, ambalajın ve/veya ek olarak gelen belgelerin üzerindeki bu semboller, elektrikli ve elektronik ürünlerin ve bataryaların genel ev atıklarıyla karıştırılmaması gerektiği anlamına gelir.

Eski ürünlerin ve kullanılmış bataryaların doğru şekilde işlenmesi, geri kazanımı ve geri dönüşümü için lütfen bunları ulusal kanunlara uygun olan toplama noktalarına götürün. Bunları doğru şekilde tasfiye ederek değerli kaynakları kurtarmaya ve insan sağlığı ve çevre üzerinde oluşabilecek olumsuz etkileri önlemeye yardım edeceksiniz.

Toplama ve geri dönüşüm hakkında daha fazla bilgi için lütfen bölgenizdeki belediye ile irtibat kurun.

Bu atığın yanlış şekilde tasfiye edilmesi durumunda ulusal kanunlar uyarınca cezalar verilebilir.

Batarya sembolüne bakın (alttaki sembol):
 Bu sembol bir kimyasal sembolü ile birlikte kullanılmış olabilir. Bu durumda batarya, kullanılan kimyasal maddeye yönelik Direktif ile belirlenen şartı karşılıyordu.



Entsorgung von Altgeräten und Batterien
Nur für die Europäische Union und Länder mit Recyclingsystemen



Dieses Symbol, auf den Produkten, der Verpackung und/oder den Begleitdokumenten, bedeutet, dass gebrauchte elektrische und elektronische Produkte sowie Batterien nicht in den allgemeinen Hausmüll gegeben werden dürfen.

Bitte führen Sie alte Produkte und verbrauchte Batterien zur Behandlung, Aufarbeitung bzw. zum Recycling gemäß den gesetzlichen Bestimmungen den zuständigen Sammelpunkten zu. Endnutzer sind in Deutschland gesetzlich zur Rückgabe von Altbatterien an einer geeigneten Annahmestelle verpflichtet. Batterien können im Handelsgeschäft unentgeltlich zurückgegeben werden.

Indem Sie diese Produkte und Batterien ordnungsgemäß entsorgen, helfen Sie dabei, wertvolle Ressourcen zu schützen und eventuelle negative Auswirkungen auf die menschliche Gesundheit und die Umwelt zu vermeiden.

Für mehr Informationen zu Sammlung und Recycling, wenden Sie sich bitte an Ihren örtlichen Abfallentsorgungsdienstleister.

Gemäß Landesvorschriften können wegen nicht ordnungsgemäßer Entsorgung dieses Abfalls Strafgeelder verhängt werden.

Hinweis für das Batteriesymbol (Symbol unten):
 Dieses Symbol kann in Kombination mit einem chemischen Symbol abgebildet sein. In diesem Fall erfolgt dieses auf Grund der Anforderungen derjenigen Richtlinien, die für die betreffende Chemikalie erlassen wurden.



L'élimination des équipements et des batteries usagés
Applicable uniquement dans les pays membres de l'Union européenne et les pays disposant de systèmes de recyclage.



Apposé sur le produit lui-même, sur son emballage, ou figurant dans la documentation qui l'accompagne, ce pictogramme indique que les piles, appareils électriques et électroniques usagés, doivent être séparés des ordures ménagères.

Afin de permettre le traitement, la valorisation et le recyclage adéquats des piles et des appareils usagés, veuillez les porter à l'un des points de collecte prévus, conformément à la législation nationale en vigueur.

En les éliminant conformément à la réglementation en vigueur, vous contribuez à éviter le gaspillage de ressources précieuses ainsi qu'à protéger la santé humaine et l'environnement.

Pour de plus amples renseignements sur la collecte et le recyclage, veuillez vous renseigner auprès des collectivités locales.

Le non-respect de la réglementation relative à l'élimination des déchets est passible d'une peine d'amende.

Note relative au pictogramme à apposer sur les piles (pictogramme du bas) :

Si ce pictogramme est combiné avec un symbole chimique, il répond également aux exigences posées par la Directive relative au produit chimique concerné.



Eliminación de Aparatos Viejos y de Pilas y Baterías
Solamente para la Unión Europea y países con sistemas de reciclado.



Estos símbolos en los productos, su embalaje o en los documentos que los acompañen significan que los productos eléctricos y electrónicos y pilas y baterías usadas no deben mezclarse con los residuos domésticos.

Para el adecuado tratamiento, recuperación y reciclaje de los productos viejos y pilas y baterías usadas llévelos a los puntos de recogida de acuerdo con su legislación nacional. En España, los usuarios están obligados a entregar las pilas en los correspondientes puntos de recogida. En cualquier caso, la entrega por los usuarios será sin coste alguno para éstos. El coste de la gestión medioambiental de los residuos de pilas, acumuladores y baterías está incluido en el precio de venta.

Si los elimina correctamente ayudará a preservar valiosos recursos y evitará potenciales efectos negativos sobre la salud de las personas y sobre el medio ambiente.

Para más información sobre la recogida u reciclaje, por favor contacte con su ayuntamiento.







Puede haber sanciones por una incorrecta eliminación de este residuo, de acuerdo con la legislación nacional.

Nota para el símbolo de pilas y baterías (símbolo debajo):

Este símbolo puede usarse en combinación con el símbolo químico. En este caso, cumple con los requisitos de la Directiva del producto químico indicado.



DISPOSAL OF UNIT

<p>Smaltimento di vecchie apparecchiature e batterie usate Solo per Unione Europea e Nazioni con sistemi di raccolta e smaltimento</p>  <p>Questi simboli sui prodotti, sull'imballaggio e/o sulle documentazioni o manuali accompagnanti i prodotti indicano che i prodotti elettrici, elettronici e le batterie usate non devono essere buttati nei rifiuti domestici generici. Per un trattamento adeguato, recupero e riciclaggio di vecchi prodotti e batterie usate vi invitiamo a portarli negli appositi punti di raccolta secondo la legislazione vigente nel vostro paese. Con uno smaltimento corretto, contribuirete a salvare importanti risorse e ad evitare i potenziali effetti negativi sulla salute umana e sull'ambiente. Per ulteriori informazioni su raccolta e riciclaggio, vi invitiamo a contattare il vostro comune. Lo smaltimento non corretto di questi rifiuti potrebbe comportare sanzioni in accordo con la legislazione nazionale.</p> <p>Note per il simbolo batterie (simbolo sotto): Questo simbolo può essere usato in combinazione con un simbolo chimico. In questo caso è conforme ai requisiti indicati dalla Direttiva per il prodotto chimico in questione.</p>	<p>Eliminação de Equipamentos Usados e Baterias Apenas para a União Europeia e países com sistemas de reciclagem</p>  <p>Estes símbolos nos produtos, embalagens, e/ou documentos que os acompanham indicam que os produtos elétricos e eletrônicos e as baterias usados não podem ser misturados com os resíduos urbanos indiferenciados. Para um tratamento adequado, reutilização e reciclagem de produtos e baterias usados, solicitamos que os coloque em pontos de recolha próprios, em conformidade com a respetiva legislação nacional. Ao eliminar estes produtos corretamente estará a ajudar a poupar recursos valiosos e a prevenir quaisquer potenciais efeitos negativos sobre o ambiente e a saúde humana. Para mais informações acerca da recolha e reciclagem, por favor contacte a sua autarquia local. De acordo com a legislação nacional podem ser aplicadas contraordenações pela eliminação incorreta destes resíduos.</p> <p>Nota para o símbolo da bateria (símbolo na parte inferior): Este símbolo pode ser utilizado conjuntamente com um símbolo químico. Neste caso estará em conformidade com o estabelecido na Diretiva referente aos produtos químicos em causa.</p>
<p>Depunerea la deșeuri a echipamentelor și a bateriilor vechi Doar pentru Uniunea Europeană și pentru țările cu sisteme de reciclare</p>  <p>Aceste simboluri de pe produse, ambalaje și/sau documentele însoțitoare indică faptul că produsele electrice și electronice, precum și bateriile uzate nu trebuie să fie amestecate cu deșeurile menajere obișnuite. Pentru un tratament corespunzător, pentru recuperarea și reciclarea produselor vechi și a bateriilor uzate, vă rugăm să le deșeurii la punctele de colectare special amenajate, în conformitate cu legislația națională. Prin depunerea corespunzătoare a acestora la deșeuri, veți ajuta la economisirea unor resurse valoroase și veți preveni potențiale efecte negative asupra sănătății umane și asupra mediului înconjurător. Pentru mai multe informații despre colectare și reciclare, vă rugăm să contactați autoritățile locale. Este posibil ca depunerea încorectă la deșeuri să fie pedepsită în conformitate cu legile naționale.</p> <p>Notă pentru simbolul de baterie (ultimele două exemple de simboluri): Acest simbol poate fi utilizat în combinație cu un simbol chimic. În acest caz, acesta este conform cu cerințele stabilite de Directivă pentru elementul chimic în cauză.</p>	<p>Indsamling af elektroniskrot og brugte batterier Kun for Den Europæiske Union og lande med retursystemer</p>  <p>Disse symboler på produkter, emballage og/eller ledsagedokumenter betyder, at brugte elektriske og elektroniske produkter og batterier ikke må blandes med almindeligt husholdningsaffald. For korrekt behandling, indsamling og genbrug af gamle produkter og batterier, skal du tage dem til indsamlingsstedet i overensstemmelse med den nationale lovgivning. Ved at skaffe sig af med dem på korrekt vis hjælper du med til at spare værdifulde ressourcer og forhindre eventuelle negative påvirkninger af menneskers sundhed og miljøet. Ønsker du mere udførlig information om indsamling og genbrug skal du kontakte din kommune. Usagkyndig bortskaffelse af elektroniskrot og batterier kan eventuelt udløse bødeforlæggelse.</p> <p>Information om batterisymbol (eksempler nedenfor): Dette symbol kan anvendes sammen med et kemisk symbol. I så fald opfylder det kravene for det direktiv, som er blevet fastlagt for det pågældende kemikalie.</p>
<p>Senų prietaisų ir akumuliatorių utilizavimas Taikoma tik Europos Sąjungai ir šalims, kuriose naudojamas perdirmo sistemos</p>  <p>Jei ant pakuotės ir (arba) lydimousiųose dokumentuose nurodytas šis simbolis, vadinasi, naudotų elektrinių ir elektroninių gaminių ir akumuliatorių negalima išmesti kartu įprastomis būtinėmis atliekomis. Senus produktus ir naudotus akumuliatorius perduokite apdirbti, likviduoti arba perdirbti kompetentingiems surinkimo punkтам pagal įstatymų galios potvarkius. Šiuos gaminius ir akumuliatorius perdavę tinkamai utilizuoti, padėsite išsaugoti vertingus išteklius ir išvengti neigiamo poveikio žmogaus sveikatai ir aplinkai. Jei norite gauti daugiau informacijos apie surinkimą ir perdirbimą, kreipkitės į vietos atliekų utilizavimo paslaugų teikėją. Remiantis šalyje galiojančiais potvarkiais, už netinkamą tokių atliekų utilizavimą gali būti skirta bauda.</p> <p>Akumuliatoriaus simbolio nuoroda (simbolu apačioje): Kartu su šiuo simboliu gali būti pateiktas cheminio medžiagų simbolis. Šis simbolis pateikiamas, kai būtina laikytis atitinkamiems chemikalams taikomų direktyvų reikalavimų.</p>	<p>Rimi ta' Tagħmir Antik u Batteriji Għall-Unjoni Ewropea u għall-pajjiżi b'sistemi ta' riċiklaġġ biss</p>  <p>Dawn is-simboli fuq il-prodotti, l-imballaġġ u/jew id-dokumenti ta' akkumpanjament ifisseru li prodotti elettrici u elettronici u batteriji użati ma jridux jiġu mħallta ma' skart domestiku ġenerali. Għal trattament, irkupru u riċiklaġġ xieraq ta' prodotti antik u batteriji użati, jekk jogħġbok hudhom f'punti tal-ġbir applikabbli f'konformità mal-leġiżlazzjoni nazzjonali tiegħek. Billi tarmiġhom b'mod xieraq, tgħin sabiex tikkonserva riżorsi prezzjużi u tipprevjeni kwalunkwe effett negattiv potenzjali fuq is-saħħa tal-bniedem u l-ambjent. Għal aktar informazzjoni dwar il-ġbir u r-riċiklaġġ, jekk jogħġbok ikkuntattja lill-municipalitá lokali tiegħek. F'każ ta' rimi mhux korrett ta' dan l-iskart jistgħu japplikaw penali, f'konformità mal-leġiżlazzjoni nazzjonali.</p> <p>Nota għas-simbolu tal-batterija (simbolu ta' taħt): Dan is-simbolu jista' jintuża f'kombinazzjoni ma' simbolu tal-kimika. F'dan il-każ jikkonforma mar-rekwiżit stabbilit mid-Direttiva għall-kimika involuta.</p>
<p>Zbrinjavanje starih uređaja i baterija Samo za Europsku uniju i zemlje koje posjeduju sustav recikliranja</p>  <p>Ovaj simbol na proizvodima, pakiranju i/ili popratnim dokumentima znači da se iskorišteni električni i električni proizvodi te baterije ne smiju bacati u kućanski otpad. Molimo vas da prema zakonskim odredbama stare proizvodnje i istrošene baterije predate na ovlaštenim sabiralištima na daljnju obradu, pripremu odn. recikliranje. Ako te proizvode i baterije propisno zbrinete, pomažete pri zaštiti dragocjenih resursa, a istovremeno i izbjegavate eventualne negativne utjecaje na ljudsko zdravlje i okoliš. Za više informacija o zbrinjavanju i recikliranju obratite se svojem lokalnom komunalnom poduzeću. Zbog nepropisnog zbrinjavanja ovog otpada mogu se, ovisno o lokalnim propisima zemlje, izreći i novčane kazne.</p> <p>Napomena za simbol baterije : Ovaj simbol može biti prikazan samo u kombinaciji s kemijskim simbolom. U tom se slučaju upotrebljava na temelju zahtjeva onih direktiva koje su donesene za dotičnu kemikaliju.</p>	

DISPOSAL OF UNIT

Avfallshandtering av produkter och batterier

Endast för Europeiska Unionen och länder med återvinningssystem



Dessa symboler på produkter, förpackningar och/eller medföljande dokument betyder att förbrukade elektriska och elektroniska produkter och batterier inte får blandas med vanliga hushållssopor.

För att gamla produkter och använda batterier ska hanteras och återvinnas på rätt sätt ska dom lämnas till passande uppsamlingsställe i enlighet med nationella bestämmelser.

Genom att ta göra det korrekt hjälper du till att spara värdefulla resurser och förhindrar eventuella negativa effekter på människors hälsa och på miljön.

För mer information om insamling och återvinning kontakta din kommun.

Olämplig avfallshandtering kan beläggas med böter i enlighet med nationella bestämmelser.

Notering till batterisymbolen (nedanför):
 Denna symbol kan användas i kombination med en kemisk symbol. I detta fall uppfyller den de krav som ställs i direktivet för den aktuella kemikalien.



Brakerinformasjon om innsamling av gammelt utstyr og brukte batterier

Bare for EU og land med retursystemer



Slike symboler på produkter, emballasje, og/eller på medfølgende dokumenter betyr at brukte elektriske/elektroniske produkter og batterier ikke må blandes med vanlig husholdningsavfall.

For riktig håndtering og gjenvinning av gamle produkter og brukte batterier, vennligst lever dem til innsamlingssteder i samsvar med nasjonallovgivning.

Ved riktig håndtering av disse produktene og batteriene, hjelper du til med å spare verdifulle ressurser og forhindre potensielle negative effekter på menneskers helse og miljø.

For mer informasjon om innsamling og gjenvinning vennligst ta kontakt med din kommune.

Ukorrekt håndtering av dette avfallet kan medføre straffansvar, i overensstemmelse med nasjonal lovgivning.

Merknader for batterisymbolen (nederste symbol):
 Dette symbolet kan bli brukt i kombinasjon med et kjemisk symbol. I dette tilfellet etterkommer det kravet satt av direktivet for det kjemikalie det gjelder.



Het ontdoen van oude apparatuur en batterijen.

Enkel voor de Europese Unie en landen met recycle systemen.



Deze symbolen op de producten, verpakkingen en/of begeleidende documenten betekenen dat gebruikte elektrische en elektronische producten en batterijen niet samen mogen worden weggegooid met de rest van het huishoudelijk afval.

Voor een juiste verwerking, hergebruik en recycling van oude producten en batterijen, gelieve deze in te leveren bij de desbetreffende inleverpunten in overeenstemming met uw nationale wetgeving.

Door ze op de juiste wijze weg te gooien, helpt u mee met het besparen van kostbare hulpbronnen en voorkomt u potentiële negatieve effecten op de volksgezondheid en het milieu.

Voor meer informatie over inzameling en recycling kunt u contact opnemen met uw plaatselijke gemeente.

Afhankelijk van uw nationale wetgeving kunnen er boetes worden opgelegd bij het onjuist weggooien van dit soort afval.

Let op: het batterij symbool (Onderstaand symbool).
 Dit symbool kan in combinatie met een chemisch symbool gebruikt worden. In dit geval volstaan de eisen, die zijn vastgesteld in de richtlijnen van de desbetreffende chemische stof.



Απόρριψη παλαιών συσκευών και μπαταριών

Μόνο για την Ευρωπαϊκή Ένωση και χώρες με συστήματα ανακύκλωσης



Το σύμβολο αυτό, πάνω στα προϊόντα, τη συσκευασία ή/και τα συνοδευτικά έγγραφα, υποδηλώνει ότι τα χρησιμοποιημένα ηλεκτρικά και ηλεκτρονικά προϊόντα, καθώς και οι μπαταρίες, δεν πρέπει να απορρίπτονται στα κοινά οικιακά απορρίμματα.

Παρακαλούμε παραδώστε τα παλαιά προϊόντα και τις χρησιμοποιημένες μπαταρίες για διαχείριση, επεξεργασία ή/και ανακύκλωση σύμφωνα με τις νομικές διατάξεις των αρμόδιων αρχών αποκομιδής.

Με την ορθή απόρριψη αυτών των προϊόντων και μπαταριών, συμβάλλετε στην εξοικονόμηση πολύτιμων πόρων και την αποφυγή τυχόν αρνητικών επιπτώσεων στην ανθρώπινη υγεία και το περιβάλλον.

Για περισσότερες πληροφορίες σχετικά με τη συλλογή και την ανακύκλωση, παρακαλούμε απευθυνθείτε στις κατά τόπους υπηρεσίες συγκομιδής απορριμάτων.

Σε περίπτωση αντικανονικής απόρριψης αυτού του προϊόντος ενδεχομένως να επιβληθούν πρόστιμα, ανάλογα με τη νομοθεσία του εκάστοτε κράτους.

Σημείωση για το σύμβολο μπαταρίας (σύμβολο κάτω):
 Το σύμβολο αυτό μπορεί να απεικονίζεται σε συνδυασμό με ένα χημικό σύμβολο. Αυτό γίνεται ώστε να υπάρχει συμφωνία με τις απαιτήσεις των εκάστοτε οδηγιών, που εκδόθηκαν για το εν λόγω χημικό.



Nolietoto elektronisko ierīču un elektropeču un bateriju utilizācija

Tikai Eiropas valstīs ar utilizācijas sistēmu



Šis simbols, kas izvietots uz ražojumiem, iesaiņojuma un/vai pavaddokumentiem nozīmē, ka nolietotās elektroniskās ierīces un elektropečas, kā arī baterijas nedrīkst izmest kopā ar parastiem mājāsaimniecības atkritumiem.

Noģādājiet nolietotos ražojumus un nokalpojušās baterijas tālākai apstrādei, pārstrādei, resp., materiālu otrreizējai pārstrādei attiecīgajās atkritumu savākšanas vietās saskaņā spēkā esošajām likumdošanas prasībām.

Nododot šos ražojumus un baterijas profesionālai utilizācijai, jūs palīdzēsiet saudzēt vērtīgu resursus un novērsīsiet iespējamo kaitējumu cilvēku veselībai un apkārtējai videi.

Lai iegūtu plašāku informāciju par atkritumu savākšanu un otrreizējo pārstrādi, lūdzam vērsties savā vietējā atkritumu pārstrādes uzņēmumā.

Saskaņā ar nacionālo likumdošanu par nepareizu šāda veida atkritumu utilizāšanu var uzlikt naudas sodu.

Norāde par baterijas simbolu (simbols apakšā):
 Šis simbols var būt attēlots kombinācijā ar ķīmiskās vielas simbolu. Tādā gadījumā tas ir apzīmēts atbilstoši attiecīgo Direktīvu prasībām, kas pieņemtas attiecībā uz attiecīgo ķīmikāliju.



Уклањање старих апарата и батерија

Само за Европску Унију и државе са системима рециклирања



Овај симбол на производима, паковању и/или пратећим документима значи да коришћени електрични и електронски апарати не смеју бити бачени у обично кућно ђубре.

Молимо да сходно законским одредбама однесете старе производе и искоришћене батерије у надлежна сабирна места на третман, прераду, односно рециклирање.

Тиме што ћете ове производе и батерије правилно уклонити помажете да се притом заштите вредни ресурси и избегну евентуална негативна дејства на људско здравље и човекову околину.

Молимо да се за више информација у вези сакупљања и рециклирања обратите Вашој месној служби за уклањање отпада.

За непрописно уклањање овог отпада могу бити изречене новчане казне према прописима државе.

Упутство за симбол за батерију (симбол доле):
 Овај симбол може бити илустрован у комбинацији са хемијским симболом. У том случају ово следи на основу захтева оних смерница које су донешене за дотичне хемикалије.



Vanade seadmete ja patareide jäätmekäitlus

Ainult Euroopa Liidule ja ringlussevõtu süsteemidega riikidele



Toodetel, pakendil ja/või kaasasolevatel dokumentidel olevad sümbolid tähendavad, et elektri- ja elektroonikatooteid ja patareisid ei tohi visata tavaliste olmejäätmete hulka.

Vanade toodete ja kasutatud patareide nõuetekohaseks töötlemiseks, taastamiseks ja ringlusse võtmiseks viige need ettenähtud kogumiskohtadesse vastavalt riiklikele õigusaktidele.

Nende toodete ja patareide korrekse kõrvaldamisega aitate säästa hinnalisi ressursse ning vältida võimalikke kahjulikke mõjusid inimeste tervisele ja keskkonnale.

Täpsema teabe saamiseks kogumise ja ringlussevõtu kohta pöörduge kohaliku omavalitsuse poole.

Vastavalt riiklikele õigusaktidele võib selliste jäätmete ebakorrektse käitlemisega kaasneda trahv.

Märkus patarei sümboli kohta :

Seda sümbolit võib kasutada kombinatsioonil keemilise sümboliga. Sellisel juhul vastab see asjaomasele kemikaali kasutamist reguleeriva direktiivi nõuetele.

TEMPERATURE RECORDER (OPTION)

The chamber temperature can be recorded and checked by installing an optional temperature recorder (MTR-G3504, MTR-0621LH, or MTR-4015LH).

✧Contact our sales representative or agent for the purchase of temperature recorder.

Main specifications of temperature recorder

	MTR-G3504	MTR-0621LH	MTR-4015LH
Application	Refrigerator & Freezer	Refrigerator	Freezer
Recording range	-60 °C to +40 °C, -10 °C to +40 °C	-6 °C to +20 °C	-40 °C to +14 °C
Feed speed of recorder chart	1-day/1 turn, 7-day/1 turn, 32-day/1 turn	31-day/batch	31-day/batch
Recorder chart	Circular type	Strip type	Strip type
Power source	Supplied from the refrigerator	Dry cell	Dry cell

✧For the installation of temperature recorder MTR-G3504, optional recorder mounting bracket MPR-S7 is necessary.

✧For the installation of temperature recorder MTR-0621LH or MTR-4015LH, optional recorder mounting bracket MPR-S30 is necessary.

BATTERY KIT FOR POWER FAILURE ALARM (OPTION)

It is recommended to install an optional battery kit for power failure alarm (MPR-48B2) to prevent the rise of chamber temperature in the case of power failure. At the power failure, the alarm activates to prompt an action for preventing the storage items.

✧Contact our sales representative or agent for the purchase of battery kit for power failure alarm.

INTERFACE BOARD (OPTION)

Two kinds of interface board are available as an optional component. MTR-480 has a connector for RS232C and a connector for RS485. MTR-L03 has a connector for LAN.

✧The interface board (MTR-480) and interface board (MTR-L03) cannot be used at the same time.

✧Contact our sales representative or agent for the purchase of interface board.

CONTAINERS FOR FREEZER (OPTION)

The containers (MPR-45FSC) can be installed on the shelves in the freezer to store the items. Up to four containers can be accommodated.

✧Contact our sales representative or agent for the purchase of containers for freezer.

ADDITIONAL SHELF KIT FOR FREEZER (OPTION)

The additional shelf kit (MPR-450ST) for freezer is available to freeze the ice packs efficiently. The shelves can be installed in the right and left freezer.

✧Contact our sales representative or agent for the purchase of additional shelf kit for freezer.

LIGHT SHIELDING PLATE (OPTION)

It is recommended to install the light shielding plate (MPR-45BP) when storing the photosensitive product in the refrigerator of MPR-450FH.

✧Contact our sales representative or agent for the purchase of light shielding plate.

SPECIFICATIONS

Product name	Pharmaceutical refrigerator	
	MPR-N450FSH	MPR-N450FH
External dimensions	W800 mm x D640 mm x H1810 mm	
Internal dimensions	W720 mm x D516 mm x H913 mm (refrigerator) W680 mm x D470 mm x H415 mm (freezer)	
Effective capacity	326 L (refrigerator), 136 L (freezer)	
Exterior	Colored steel	
Interior	Vacuum molding (ABS resin) (refrigerator) Painted steel (freezer)	
Door	Painted steel without glass window x 2 (refrigerator) Painted steel x 2 (freezer)	Painted steel with 3-layer glass window x 2 (refrigerator) Painted steel x 2 (freezer)
Insulation	Rigid polyurethane foamed-in place	
Shelf	Tempered glass x 3, Allowable load; 25 kg/shelf (refrigerator) Hard steel wire on polyethylene coating x 2, Allowable load; 15 kg/shelf (freezer)	
Bottom shelf	Hard steel wire on polyethylene coating x 2 (freezer)	
Access port	Inner diameter; 30 mm, 2 locations (back of refrigerator and freezer)	
Cooling method	Forced cool air circulation (refrigerator), Direct cooling (freezer)	
Compressor	Inverter type, Output; 120 W (refrigerator) Hermetic type, Output; 170 W (freezer)	
Evaporator	Fin and tube type (refrigerator), Tube on sheet type (freezer)	
Condenser	Skin condenser (refrigerator, freezer)	
Refrigerant	R-600a (refrigerator), R-290 (freezer)	
Defrosting	Cycle defrost + forced defrost (refrigerator) Natural defrost by stopping operation (Freezer)	
Defrost heater	80 W (refrigerator)	
Temperature controller	Microcomputer control system	
Temperature display	Digital display (in 1 °C, 0.1 °C increments)	
Thermal sensor	Thermistor sensor	
Memory back-up	Nonvolatile memory	
Interior light	LED (refrigerator)	
Weight	121 kg	129 kg
Accessories	2 keys, 2 large/4 small nylon clips (for temperature recorder)	
Optional components	Temperature recorder (MTR-G3504, MTR-0621LH, MTR-4015LH) Recorder mounting bracket (MPR-S7, MPR-S30) Interface board (MTR-480, MTR-L03)* Battery kit for power failure alarm (MPR-48B2) Container for freezer (MPR-45FSC) Additional shelf kit for freezer (MPR-450ST) Light shielding plate (MPR-45BP) for MPR-N450FH	

◇ Design or specifications are subject to change without notice.

◇ Refer to the updated catalog when ordering an optional component.

*It is recommended to use standard signal and interface cables with a maximum length of 30 meters.

PERFORMANCE

Product name	Pharmaceutical Refrigerator MPR-N450FSH		
Model number	MPR-N450FSH-PE		
Temperature control range	Refrigerator; 2 °C to 14 °C (ambient temperature; -5 °C to 35 °C, no load) Freezer; -30 °C to -20 °C (ambient temperature; -5 °C to 35 °C, no load)		
Rated voltage	AC 220 V	AC 230 V	AC 240 V
Rated frequency	50 Hz	50 Hz	50 Hz
Amperage	1.2 A	1.2 A	1.1 A
Rated power consumption	215 W	215 W	220 W
Usable environment condition	Temperature; -5 °C to 35 °C, Humidity; equal or less than 80 %R.H.		

Product name	Pharmaceutical Refrigerator MPR-N450FH		
Model number	MPR-N450FH-PE		
Temperature control range	Refrigerator; 2 °C to 14 °C (ambient temperature; -5 °C to 35 °C, no load) Freezer; -30 °C to -20 °C (ambient temperature; -5 °C to 35 °C, no load)		
Rated voltage	AC 220 V	AC 230 V	AC 240 V
Rated frequency	50 Hz	50 Hz	50 Hz
Amperage	1.2 A	1.2 A	1.1 A
Rated power consumption	215 W	215 W	220 W
Usable environment condition	Temperature; -5 °C to 35 °C, Humidity; equal or less than 80 %R.H.		

Product name	Pharmaceutical Refrigerator MPR-N450FSH		
Model number	MPR-N450FSH-PA		
Temperature control range	Refrigerator; 2 °C to 14 °C (ambient temperature; -5 °C to 35 °C, no load) Freezer; -30 °C to -20 °C (ambient temperature; -5 °C to 35 °C, no load)		
Rated voltage	AC 115 V		
Rated frequency	60 Hz		
Amperage	3.7 A		
Rated power consumption	370 W		
Usable environment condition	Temperature; -5 °C to 35 °C, Humidity; equal or less than 80 %R.H.		

Product name	Pharmaceutical Refrigerator MPR-N450FH		
Model number	MPR-N450FH-PA		
Temperature control range	Refrigerator; 2 °C to 14 °C (ambient temperature; -5 °C to 35 °C, no load) Freezer; -30 °C to -20 °C (ambient temperature; -5 °C to 35 °C, no load)		
Rated voltage	AC 115 V		
Rated frequency	60 Hz		
Amperage	3.7 A		
Rated power consumption	370 W		
Usable environment condition	Temperature; -5 °C to 35 °C, Humidity; equal or less than 80 %R.H.		

- ◇The above data is measured based on our internal procedures.
- ◇Design or specifications are subject to change without notice.

CAUTION

Please fill in this form before servicing.
Hand over this form to the service engineer to keep for his and your safety.

Safety check sheet

1. Unit contents:

- Risk of infection: Yes No
Risk of toxicity: Yes No
Risk from radioactive sources: Yes No

(List all potentially hazardous materials that have been stored in this unit.)

Notes:

2. Contamination of the unit:

Unit interior:

- No contamination: Yes No
Decontaminated: Yes No
Contaminated: Yes No

Others:

3. Instructions for safe repair/maintenance/disposal of the unit

- a) The unit is safe to work on Yes No
b) There is some danger (see below) Yes No

Procedure to be adhered to in order to reduce safety risk indicated in b) below.

Date:

Signature:

Address, Division:

Telephone:

Product name: Pharmaceutical Refrigerator	Model: MPR-	Serial number:	Date of Installation:
---	----------------	----------------	-----------------------

Please decontaminate the unit yourself before calling the service engineer.

PHC Corporation

1-1-1 Sakada, Oizumi-machi, Ora-gun, Gunma 370-0596, Japan

© PHC Corporation 2018

Printed in Taiwan
LDCL050200-3
S0918-30119
(Jan. 11, 2019)