



Operating Instructions

Ultra-Low Temperature Freezer

MDF-DU703VH

MDF-DU503VH

MDF-DU703VHA

MDF-DU503VHA



MDF-DU703VH

Please read the operating instructions carefully before using this product, and keep the operating instructions for future use.

See page 100 for all model numbers.

CONTENTS

1. BEFORE USING

SAFETY PRECAUTIONS.....	5
SYMBOLS ON UNIT	9
FOR SAFELY STORING SAMPLES	10
About backup cooling system	10
In the event of emergency	11
INSTALLATION SITE	12
INSTALLATION	13
FREEZER COMPONENTS	14
Main body	14
Accessories	16
Remote alarm terminals.....	16
START-UP PROCEDURE	17
Operation during power failure	18
Operation after recovery from power failure	18

2. TOUCH PANEL OPERATION

USING THE TOUCH PANEL.....	19
Basic Operation	19
Entering alphanumeric values and dates.....	19
Other operations	21
HOME SCREEN.....	22
SIDEBAR MENU BUTTONS	24

3. SECURITY MODE

SETTING SECURITY MODE	26
Introduction to the security mode.....	26
Setting the security mode to ON.....	27
Setting the security mode to OFF	29
ACCOUNT MANAGEMENT BY ADMINISTRATOR	30
Creating a user account.....	30
Viewing user account list	36
Changing user account data.....	37
Deleting a user account	41
ACCOUNT OPERATION BY GENERAL USER	42
Registering a face recognition image and an IC card/NFC device	42
Viewing your account information	46
Changing user account data.....	46
ELECTRIC LOCK AND LOGIN/LOGOUT	50
About electric lock.....	50
Setting electric lock (log in/log out method)	51
Unlocking (logging in) by the Login button.....	53
Unlocking (logging in) by auto face recognition	56
Unlocking (logging in) by NFC authentication.....	57
Locking/unlocking the outer door during power failure	58

4. SETTINGS AND OPERATION

SETTING FOR BASIC OPERATION.....	59
Setting temperature and high/low alarms	59
Configuring other alarm settings and compressor delay time.....	60
About alarm test.....	61

SCREEN LOCK.....	62
Setting screen lock	62
Operation when screen lock is ON	64
Turning OFF the screen lock setting.....	64
OTHER SETTINGS	66
Setting date and time	66
Setting brightness and sleep	67
Setting unit name	68
Setting DAQ.....	69
EVENT LOG	70
Event Log screen.....	70
Viewing the event log data.....	71
Viewing and acknowledging pending items	72
Exporting event log data	73
OPERATION LOG CHART	76
Chart screen	76
Displaying operation log chart	77
Exporting operation log data.....	78
IMPORTING/EXPORTING DATA	79
Exporting log data	79
Exporting user account data and freezer setting data	81
Importing user account data	82
Importing freezer setting data	84
5. MAINTENANCE AND TROUBLESHOOTING	
ALARMS AND SELF-DIAGNOSIS	86
Alarm messages	86
Notice messages	87
Alarm and Buzzer Stop button.....	88
ROUTINE MAINTENANCE	89
Cleaning the exterior, interior, and accessories	89
Cleaning the condenser filter	89
Defrosting the chamber	90
CALIBRATION.....	90
REPLACEMENT OF CONSUMABLE PARTS.....	91
Replacing the battery for power failure alarm	91
Replacing the battery for backup cooling system (option).....	91
TROUBLESHOOTING	92
DISPOSAL OF UNIT	94
Recycle of battery	94
Deleting personal information (user account data).....	94
6. OPTIONS & SPECIFICATIONS etc.	
OPTIONAL COMPONENTS.....	95
NFC Reader (MTR-NFC).....	95
IC card (MTR-IC)	95
Temperature recorder (MTR-G85A).....	95
Small inner doors (MDF-5ID4/5ID5, MDF-7ID4/7ID5)	96
Backup cooling kit (MDF-UB9)	96
SETTING OF SHELF STOPPERS WHEN USING INVENTORY RACKS	97
SPECIFICATIONS.....	98
PERFORMANCE	100
SAFETY ENVIRONMENTAL CONDITIONS	101
SAFETY CHECK SHEET	102
USE OF OPEN-SOURCE SOFTWARE	103

1. BEFORE USING

INTRODUCTION

- Read the operating instructions carefully before using the product and follow the instructions for safe operation.
- PHC Corporation takes no responsibility for safety if the product is not used as intended or is used with any procedures other than those given in the operating instructions.
- Keep the operating instructions in a suitable place so that they can be referred to as necessary.
- The operating instructions are subject to change without notice for improvement of performance or function.
- Contact our sales representative or agent if any page of the operating instructions is missing or the page order is incorrect, or if the instructions are unclear or inaccurate.
- No part of the operating instructions may be reproduced in any form without the express written permission of PHC Corporation.

IMPORTANT NOTICE

PHC Corporation guarantees this product under certain warranty conditions. However, please note that PHC Corporation shall not be responsible for:

- any loss or damage to the contents of the product
- any indirect damage caused by data damage or loss
- any damage caused by the use of the face recognition function or inoperative face recognition function

<Intended Use>

This equipment is designed for low temperature storage of biomedical samples.

SAFETY PRECAUTIONS

Be sure to observe the operating instructions as they contain important safety advice.

For correct and safety use of the product, follow the precautions and procedures in this operating instructions carefully. Failure to do so could result in injury or damage to the product.

Precautions are illustrated in the following way:







WARNING

Warning indicates a potentially hazardous situation which, if not avoided, could result in serious injury or death.

CAUTION

Failure to observe CAUTION signs could result in injury to personnel and damage to the unit and associated property.

The following symbols are used in this document and some of them are attached to the unit.

	<p>Actions are prohibited. The illustration in the circle and the description adjacent to the symbol provide detailed information about the action which is prohibited.</p>
	<p>Actions are mandatory. The illustration in the circle and the description adjacent to the symbol provide detailed information about the action to be taken.</p>
	<p>Caution must be taken. The description adjacent to the symbol provides detailed information about the caution to be taken.</p>
	<p>This symbol indicates the possibility of an electric shock. High-voltage electrical components are placed under the covers. Only a qualified engineer or service personnel should be allowed to open these covers.</p>
	<p>This symbol indicates that there is flammable gas inside the unit. There may be a risk of fire or explosion. Keep away from any ignition sources.</p>
	<p>This symbol indicates low temperature or freezing conditions. Take care to avoid exposure to low temperature or freezing conditions.</p>
	<p>This symbol indicates earth. Connect the earth terminal to the ground to prevent an electric shock.</p>

For the State of California, USA Only:

This product contains a CR Coin Cell Lithium Battery which contains Perchlorate Material – special handling may apply. See www.dtsc.ca.gov/hazardouswaste/perchlorate.

SAFETY PRECAUTIONS

WARNING

Installation



- **Do not use the unit outdoors.**
Exposure to rain may cause an electric leakage and/or an electric shock.
- **Do not install the unit in a location where flammable or volatile substances are present.**
Installing the unit in such a location may cause explosions and/or a fire.
- **Do not install the unit in a location where there are high levels of moisture or where it may be splashed with water.**
This may cause the insulation to deteriorate, leading to an electric leakage and/or an electric shock.
- **Do not install the unit in a location where corrosive gases such as acids are present.**
Deterioration of the insulation due to corrosion of the electric components may cause an electric leakage or an electric shock. Also, corrosion of the refrigerant piping can result in explosions and/or a fire caused by gas leakage.
- **Do not leave the plastic bags used for packing in a place where they can be reached by small children.**
This may result in unexpected accidents such as suffocation.



- **Only qualified engineers or service personnel should install the unit.**
Installation by unqualified personnel may cause water leakage, an electric shock, or a fire.
- **Install the unit in a location capable of bearing the total combined weight (product + optional accessories + stored items). After installing the unit, be absolutely sure to take precautions to prevent the unit from falling over.**
If the unit is installed in a location which is not strong enough or if the proper precautions are not taken, the unit may fall over and cause injuries.
- **Connect the unit to a dedicated power source as indicated on the rating label attached to the unit.**
Use of any other voltage or frequency other than that on the rating label may cause a fire or an electric shock. Also, a power strip may cause a fire resulting from abnormal heating.
- **When handling harmful samples (for example, those which consist of toxic, pathogenic or radioactive substances), install the unit inside a designated isolation facility.**
If the unit is installed in a location other than an isolation facility, there may be detrimental effects on both people and the natural environment.
- **Install the unit in a well-ventilated (airy) location to prevent the accumulation of flammable refrigerant.**
 - If flammable refrigerant leaks, it may accumulate and cause explosions or a fire.
 - (When optional backup cooling system is installed) As with any equipment that uses CO₂ gas, there is a likelihood of oxygen depletion in the vicinity of the equipment. It is important that you assess the work site to ensure there is suitable and sufficient ventilation. If lack of ventilation is suspected, then other methods of ensuring a safe environment must be considered. These may include atmosphere monitoring systems and warning devices with alarms.
- **Risk of fire or explosion. Flammable refrigerant used.**
The unit contains flammable refrigerant. Consult repair manual/owner's guide before attempting to install or service this product. All safety precautions must be followed.
- **This unit must be plugged into a dedicated circuit protected by branch circuit breaker.**
Otherwise it may cause an electric shock or a fire.



- **Be absolutely sure to earth (ground) the unit to prevent an electric shock.**
Failure to earth the product may cause an electric shock. If necessary, ask a qualified contractor to do this work.
- **Do not connect the earth wire to a gas pipe, water pipe, or lightning rod when earthing the unit.**
Earthing the unit improperly may cause an electric shock.

⚠ WARNING

Power supply plug and cord



- **Never damage the power supply cord or power supply plug (by breaking, adapting, placing near a source of heat, bending with force, twisting, pulling, adding weight, or binding).**

A damaged power supply cord or power supply plug may cause an electric shock, a short circuit, or a fire. Contact our sales representative or agent for repairing the cord and plug.

- **Do not place this unit or other equipment in a position where it is difficult to disconnect the power supply plug.**

Failure to disconnect the power supply plug may cause a fire in the event of a problem or malfunction.

- **Do not pull the power supply cord, the power supply plug, or the product side plug (inlet part) hard (MDF-DU703/503VHA-PA).**

If the cord breaks, it may cause electric shock or fire.

- **Do not use power cord for other electrical equipment (MDF-DU703/503VHA-PA).**

Such power supply cord may cause fire or electric shock.



- **Do not plug or unplug the power supply plug with wet hands.**

This may cause an electric shock.



- **Remove dust from the power supply plug periodically.**

Dust on the power supply plug may lead to an insulation failure due to moisture and thus cause a fire. Disconnect the power supply plug and wipe it with a dry cloth.

- **Make sure the power supply plug is pushed fully in.**

Faulty insertion of the power supply plug may cause an electric shock or a fire due to a generation of heat. Never use a damaged power supply plug or loose power outlet.

- **Grip the power supply plug when disconnecting the power supply cord from the outlet.**

Pulling the power supply cord may cause an electric shock or a short circuit.

- **Always use the detachable power supply cord that came with the product (MDF-DU703/503VHA-PA).**

Other power supply cord may cause electric shock or fire.



- **Disconnect the power supply plug before moving the unit.**

Take care not to damage the power supply cord. A damaged power supply cord may cause an electric shock or a fire.

- **Disconnect the power supply plug when the unit is not in use for long periods.**

Keeping the unit connected may cause an electric shock, an electric leakage, or a fire due to the deterioration of insulation.

- **Before proceeding with maintenance or checking the unit, turn the power switch OFF (if the switch is provided), and disconnect the power supply plug.**

Performing the work while power is still being supplied to the product or while the power supply plug is still connected may cause an electric shock and/or injuries.

When something is wrong with the unit



- **Never disassemble, repair, or modify the unit yourself.**

A high-voltage area is located inside the unit. Any work carried out by unauthorized personnel may result in an electric shock. Contact our sales representative or agent for maintenance or repair.



- **Disconnect the power supply plug if something is wrong with the unit.**

If the unit keeps running under such conditions, there may be a risk of an electric shock or a fire. Contact our sales representative or agent immediately for maintenance or repair.



- **Use designated parts for parts replacement.**

Using an incorrect part may cause a fire.

SAFETY PRECAUTIONS

WARNING

When using the unit



- **Never put containers with liquid on top of the unit.**
This may cause an electric shock or short circuit if the liquid is spilled.
- **Never insert metal objects such as pins and wires into any vent, gap, or outlet on the unit.**
This may cause an electric shock or injury by accidental contact with moving parts.
- **Do not use equipment or other measures for facilitating the defrosting work.**
It may cause explosions and/or a fire in case of refrigerant leakage.



- **Never splash water directly onto the unit.**
This may cause an electric shock or short circuit.



- **Never store volatile or flammable substances in this unit except in a sealed container.**
Such substances may cause an explosion or a fire if they leak.
- **Ask a qualified contractor to carry out replacement of the battery for the power failure alarm and the battery for backup cooling system.**
Improper handling will result in an electric shock or a fire.



- **Do not give strong shock or vibration when moving or using the unit.**
The piping may be damaged, causing a fire.
- **Never damage the chamber wall or pipework in the chamber when removing frost.**
It may cause explosions and/or a fire in case of refrigerant leakage.



- **Flammable and explosive product.**
The unit contains flammable refrigerant. When repairing or recycling the unit, only trained service personnel should perform the work. Follow the procedure below.
 - Well ventilate the room to prevent refrigerant accumulation.
 - Keep fire away when the refrigerant is contained in the product.
 - Do not damage or break the pipework.It may cause explosions and/or a fire in case of refrigerant leakage.

When storing and disposing the unit



- **If the unit is to be stored unused in an unsupervised area for a long period, ensure that children do not have access to the unit and that doors cannot be closed completely.**
There may be a risk of child entrapment.
- **Ask a qualified contractor to carry out disassembly/disposal of the unit and do not leave the unit in a location that can be accessed by third parties**
This may result in unexpected accidents (e.g. the unit may be used for unintended purposes).
- **The unit contains flammable refrigerant. When the unit is disassembled or disposed of, the work must be performed in a well-ventilated place and avoid the place near fire.**
It may cause explosions and/or a fire in case of refrigerant leakage.

CAUTION



- **Do not touch stored samples in the chamber or inner walls of the chamber with bare hands.**

Frostbite can occur at low temperatures. Wear insulated gloves when reaching into the chamber.



- **Do not climb on top of the unit or put any objects on the unit.**

Falling from the unit may cause injury; falling objects may cause damage to the unit.



- **Turn the leveling feet to raise the casters above the floor and secure the unit.**

If they are left touching the floor, the unit may inadvertently move out of position when its door is opened or closed. It may cause injury.

- **Never store corrosive substances such as acids or alkalis in this unit except in a sealed container.**

These may be harmful to your health and may cause corrosion of internal components or electrical parts.

- **Wear protective gloves when handling frozen items or cleaning the chamber.**

Without gloves, you may get frostbite or get injured by the corners of interior parts.

Also, touching or inhaling chemicals or aerosols from around the unit may be detrimental to health.



- **When moving the unit, be sure to take precautions to prevent it from falling over.**

Moving the unit with too much force may cause it to fall over, possibly resulting in injury. A qualified individual must be assigned to supervise the safe movement and relocation of the unit.

- **Set up or remove the shelf with both hands.**





If the shelf falls down, it may cause injury.

- **When using the optional inventory racks, be careful not to drop the racks.**

If the rack falls down, it may cause injury or damage to the contents.

SYMBOLS ON UNIT

The following symbols are attached to the unit.

	This symbol indicates possibility of an electric shock. High-voltage electrical components are placed under the covers. Only a qualified engineer or service personnel should be allowed to open these covers.
	This symbol indicates that caution is required. Refer to product documentation for details.
	This symbol indicates incorrect usage could lead to a fire hazard.
	This symbol indicates low temperature or freezing conditions. Take care to avoid exposure to low temperature or freezing conditions.
	This symbol indicates an earth.
	This symbol indicates the "ON" for the power switch.
○	This symbol indicates the "OFF" for the power switch.

FOR SAFELY STORING SAMPLES

Ultra-low temperature freezers control temperature by mechanical systems that run on electricity. If the systems stop due to a power failure or some other reason, the temperature in the freezer rises. The following tips can help protect your valuable samples from unexpected failure of the freezer.

- Store valuable samples separately into multiple ultra-low temperature freezers.
- Install the backup cooling system and remote alarm system for protecting samples.
- Use the remote alarm system to ensure that the alarm notifies the administrator of the unusual status of the freezer. Especially, the use of the remote alarm system is recommended if the freezer is placed in an unattended environment.
- Replace the battery for backup cooling system and the battery for power failure alarm every three years. They are consumable parts. If the battery drains, audible alarms do not sound and the backup cooling system does not work. Contact our sales representative or agent for the replacement of the batteries.

Note:

PHC Corporation shall not be responsible for any loss or damage to the samples stored in the freezer.

About backup cooling system

When the unit stops operation in the event of a power failure, the optional backup cooling kit MDF-UB9 and the liquid CO₂ cylinder can prevent the chamber temperature from rising for several hours by injecting liquid CO₂ into the chamber. For details about the backup cooling system, refer to page 96. For purchase of the backup cooling kit, contact our sales representative or agent.

Note:

The cooling function of the backup cooling system can last only several hours even if the liquid CO₂ cylinder is full. Also, degradation of the battery shortens the cooling duration. The duration of time for which a full 30 kg liquid CO₂ cylinder can keep the chamber at -70 °C varies depending on the size of the freezer and the volume of samples in the chamber. The following graphs show examples of the duration.

[Example] Duration of time for which a full 30 kg liquid CO₂ cylinder can keep the chamber at -70 °C (no load)

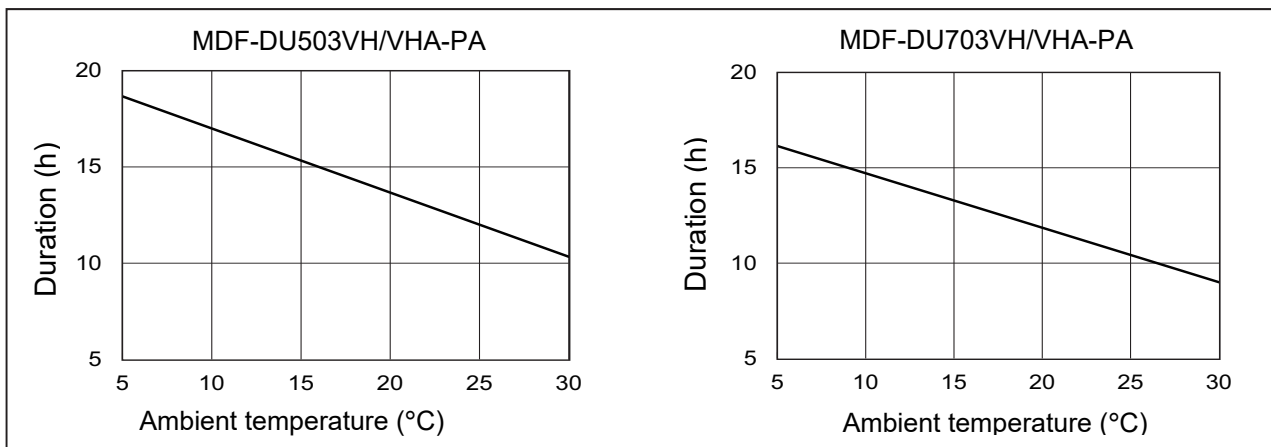

Notes:

- If the backup cooling system is used in a small room, or many freezers with backup cooling system are in a same room, a large amount of CO₂ gas is injected or released in the room. This may cause oxygen lack temporarily. For safety operation, install an alarm sensor and a ventilation device.
- Injecting liquid CO₂ into the chamber decreases pH in the chamber. Therefore, care should be taken for the samples that may be affected.

In the event of emergency

When the audible alarm sounds or the remote alarm is activated, determine the cause of the alarm immediately. If the temperature in the freezer has risen, take the following measures.

- Make sure to determine the cause of the temperature rise.

The alarm status continues until the temperature in the chamber falls below the temperature set to the High Alarm temperature on the Temp. Settings screen. If the alarm status continues for more than an hour, or the chamber temperature does not fall, the freezer may be malfunctioning. Move the samples into a different freezer immediately and contact our sales representative or agent.

If there are no other ultra-low temperature freezers, protect your samples using the backup cooling system or dry ice.

- In the event of a power failure, check the duration and take alternate measures to cool the samples. If the power failure is expected to continue for several hours, protect your samples using the backup cooling system or dry ice.

- Amount of dry ice

To keep MDF-DU503VH/VHA (inner capacity: 528 L) to -70°C , firstly, put at least 25 kg of dry ice into the chamber. Then, add 2.5 kg of dry ice every hour. Wrap dry ice with paper such as newspaper and put it on each shelf equally.

To keep MDF-DU703VH/VHA (inner capacity: 729 L) to -70°C , firstly, put at least 35 kg of dry ice into the chamber. Then, add 3.5 kg of dry ice every hour. Wrap dry ice with paper such as newspaper and put it on each shelf equally.

Note:

The CO_2 gas concentration in the chamber becomes high after the sublimation of the dry ice. The pH of the water solution that does not include buffer solution may become lower if it is left under such an atmosphere for a long time.

[Example] Characteristics of chamber temperature rise during power failure (no load)

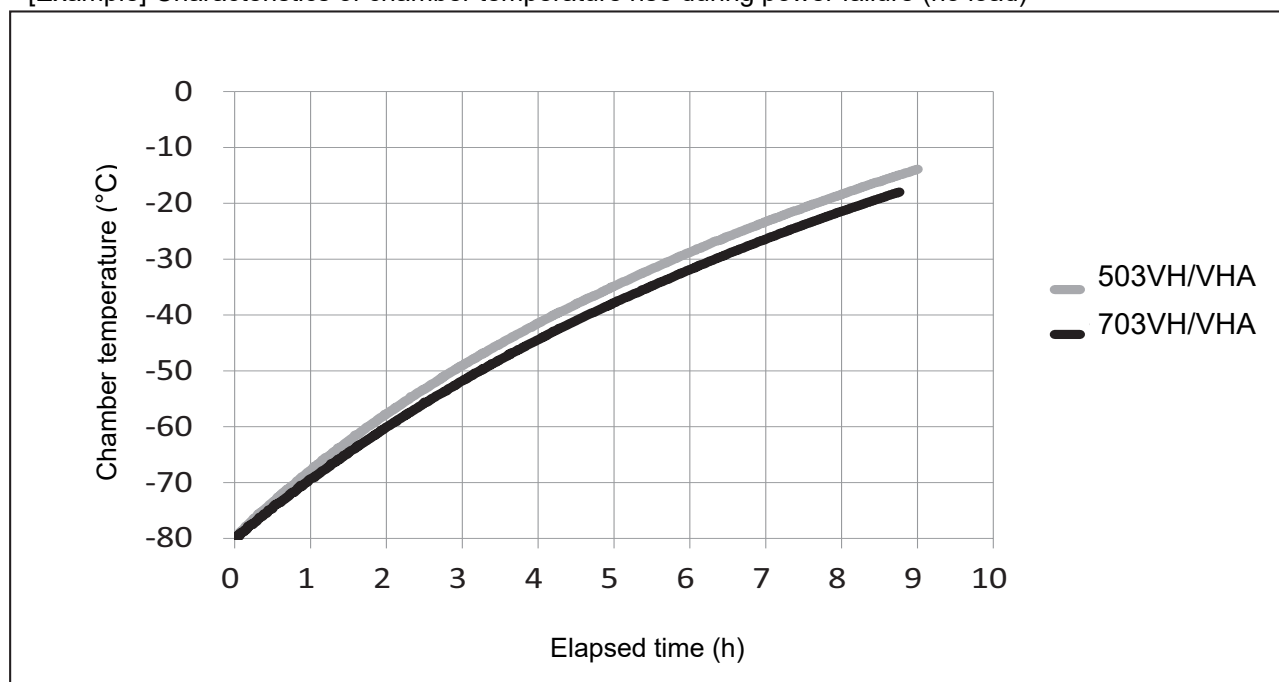

INSTALLATION SITE

To run the freezer unit properly, the unit must be installed in a location which meets all the conditions described below. If the location does not meet these conditions, the specified performance of the unit may not be achieved or malfunctions and accidents may occur.

■ **A location not exposed to direct sunlight**

Avoid any location which is exposed to direct sunlight. Installing the unit in a location exposed to direct sunlight may degrade its cooling performance.

■ **A well-ventilated (airy) location**

In order to ensure ventilation, leave clearances of at least 10 cm around the unit (at the left, right, top and back). Blocking the ventilation may degrade the unit's cooling performance or cause the unit to malfunction.

■ **A location away from heat sources**

Avoid any location which is close to a major source of heat (such as a heater or boiler). Installing the unit near a major source of heat may degrade the unit's cooling performance.

■ **A location with minimal changes in temperature**

Avoid any location where the ambient temperature is subject to sudden changes. If the unit is installed in such a location, stable cooling performance may not be achieved. The ambient temperature for using this product is 5 °C to 30 °C.

■ **A firm and level location where the floor can bear the total combined weight (product + optional accessories + stored items)**

Install the unit on a level surface which is capable of bearing the total combined weight (product + optional accessories + stored items). If the unit is installed in a location where the floor surface is uneven or where the unit will be inclined at an angle, the unit will be unstable, and accidents or injuries may occur and/or unnecessary vibration or noise may be generated.

■ **A location with minimal humidity**

Install the unit in a location where the relative humidity is 80 %R.H. or lower. Installing the unit in a very humid location may cause earth faults and/or electric shock.

■ **A location free of flammable or corrosive gases**

Avoid any location exposed to flammable or corrosive gases. Flammable or corrosive gases can cause explosions and/or a fire. Furthermore, corrosion of the electrical parts may cause the insulation to be deteriorated and result in earth faults and/or electric shock.

■ **A location where corrosive materials are not generated**

Never install the unit in a location where corrosive materials such as sulphur compounds are likely to be generated (e.g. near a drainage facility). Corrosion of the copper pipes may result in the deterioration and consequently the failure of the cooling unit.

■ **A location where nothing can fall onto the unit**

Avoid locations where objects may fall onto the unit. Objects falling and hitting the unit may cause it to break down or fail.

Note:

Keep electric products which emit electromagnetic waves away from the unit. A noise from the electromagnetic waves may cause the unit to malfunction.

INSTALLATION

When installing the unit, follow the steps below to secure the unit properly.

1. Preparations after unpacking

Remove all the tape used to secure the doors and interior parts, and leave the doors open for a short while for ventilation. If any outer surfaces of the freezer are dirty, wipe the surfaces using a cloth moistened with a diluted neutral dish-washing detergent (using an undiluted solution of detergent may cause the unit's plastic areas to crack. Follow the directions on the detergent for details of dilution).

After wiping the unit using the diluted detergent, be sure to wipe the surfaces with a cloth dipped in clean water to remove traces of the detergent. After this, be sure to wipe the surfaces with a dry cloth, allowing the outer surfaces of the freezer to dry out completely, and then proceed with the installation.

Note:

Remove the cable tie that bands the power supply cord. Prolonged contact with the tie may cause corrosion of the cord coating.

2. Securing and leveling the unit using the leveling feet

Rotate the front leveling feet clockwise until the casters are raised 5 mm to 10 mm above the floor surface (Fig. 1).

Then, rotate the leveling feet slightly clockwise or anticlockwise to adjust them so that the unit is completely level.

- The unit becomes stable with the casters not contacting the floor. If the casters are left in contact with the floor, the unit may accidentally move when its door is opened or closed.

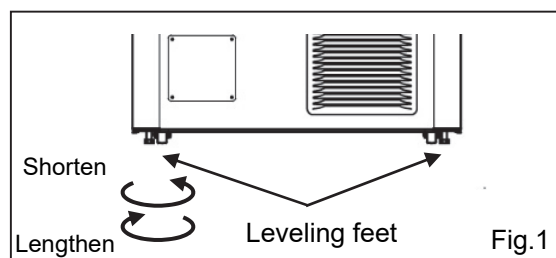

Fig. 1

3. Securing the unit using fixtures

Use the fixtures on the back panel of the unit, and secure the unit to the wall by passing a strong rope or chain through the fixtures (Fig. 2).

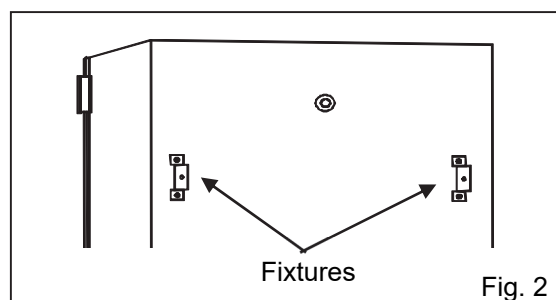

Fig. 2

4. Preventing electric shock by earthing the unit

When installing the unit, be sure to earth (ground) it. Earthing is necessary to prevent electric shock resulting from deterioration of electrical insulations.

- This unit comes with a power plug having one earth pin. Earthing work is not required in the case of a power outlet equipped with an earth contact.
- If the power outlet is not equipped with an earth contact, ask a qualified contractor to do the earthing work.

MDF-DU503VH-PA MDF-DU703VH-PA	MDF-DU503VHA-PA MDF-DU703VHA-PA
Plug: NEMA 6-15P	Plug: NEMA 5-15P
Receptacle: NEMA 6-15R	Receptacle: NEMA 5-15R

Fig. 3

5. Setting up the shelves

Insert the shelf stoppers into the bores of the pilasters at the desired level and set the shelf firmly on the shelf stoppers (Fig. 4).

When using the optional inventory racks, insert the shelf stoppers into the bores at the positions of the pilasters described in "SETTING OF SHELF STOPPERS WHEN USING INVENTORY RACKS (page 97)" and set the shelves on the shelf stoppers.

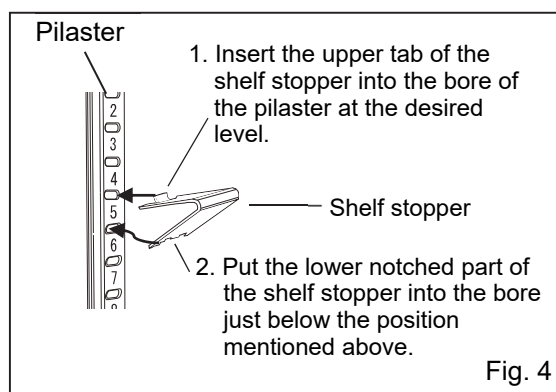
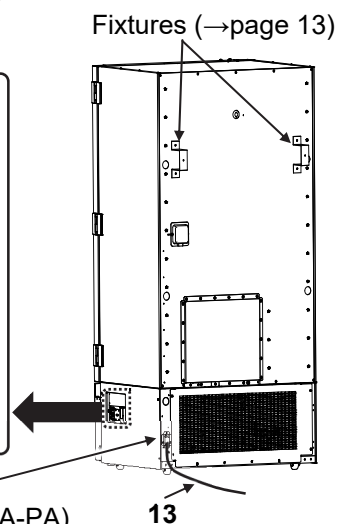
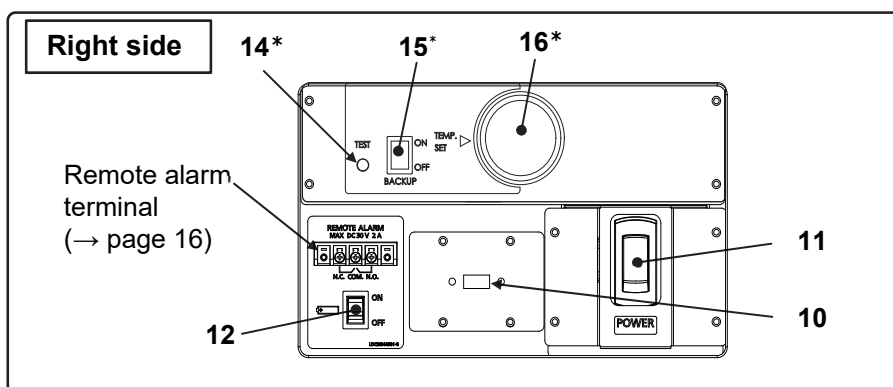
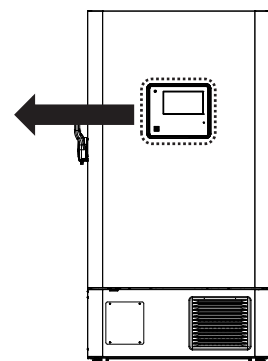
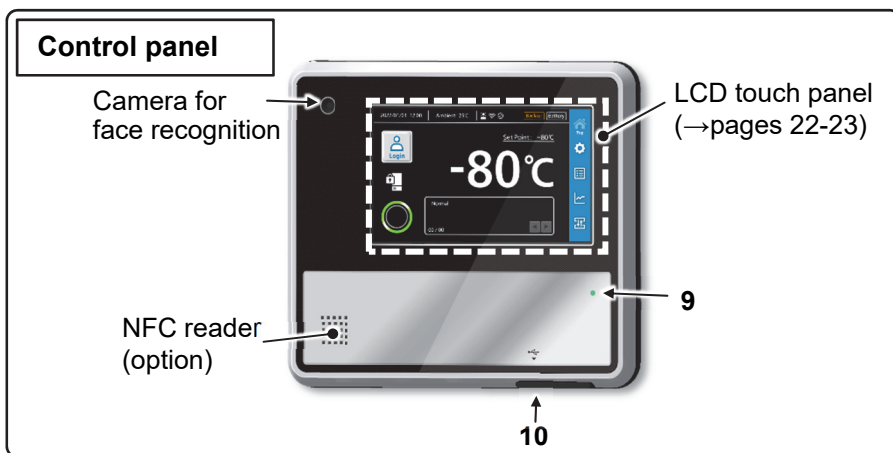
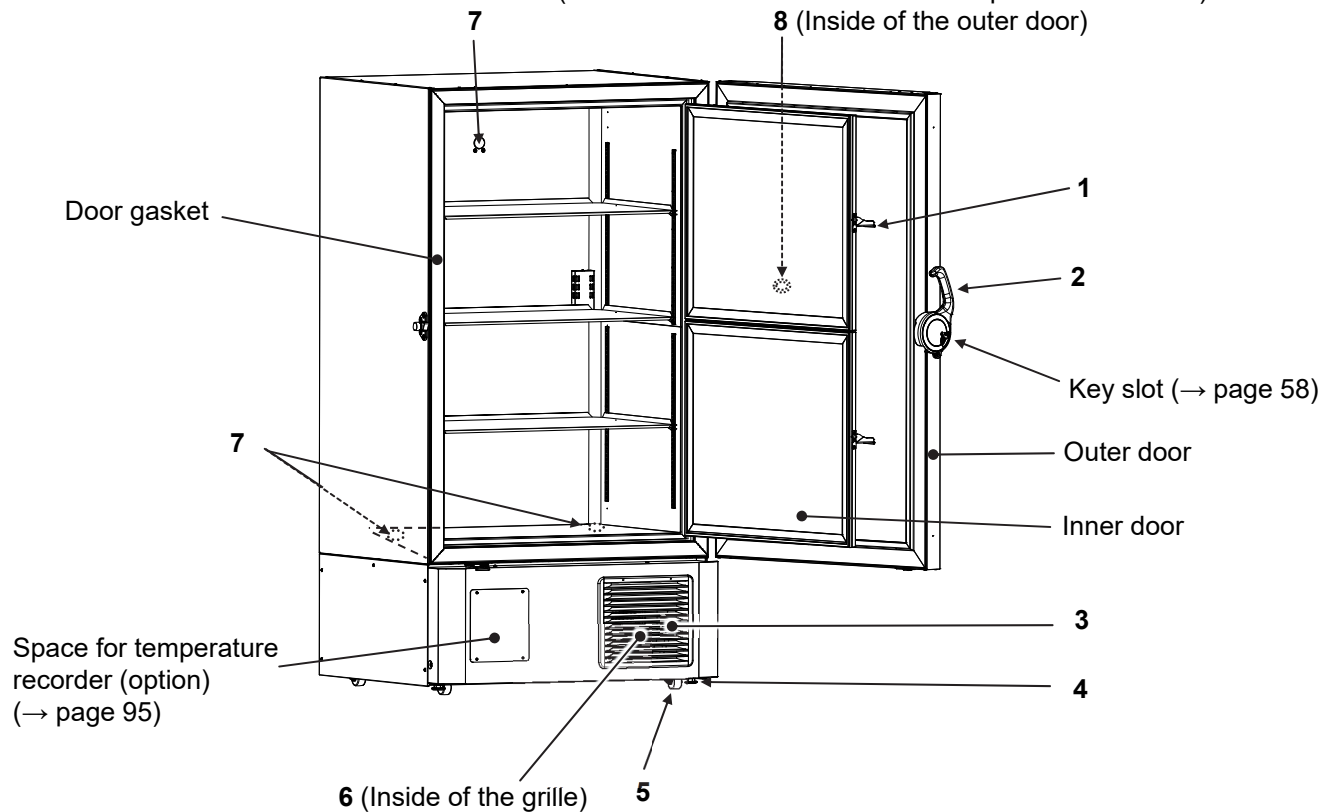

Fig. 4

FREEZER COMPONENTS

Main body

The model below shows MDF-DU703VH/VHA (MDF-DU503VH/VHA also has an equivalent structure).



* When the optional backup cooling system is installed.

Inlet (MDF-DU703/503VHA-PA)

1. Inner door latch: The inner door can be securely closed using this inner door latch. When closing the inner door, make sure to engage the latch. Otherwise, the samples in the chamber may be damaged due to the temperature changes in the chamber.

2. Outer door handle: Used for opening and closing the outer door. The latch is provided at the bottom of the handle for securely closing the outer door. When closing the outer door, grab the handle firmly and push it towards the cabinet side to engage the latch. Otherwise, samples in the chamber may be damaged due to the temperature changes in the chamber. When opening the outer door, grab the handle firmly and pull it towards you. At the latch part, the hole for a commercially available padlock is also provided.

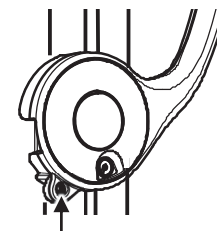

Padlock position [Fig. 1]

3. Grille (air intake vent): The outer air is taken into the chamber from this vent. Do not block this vent. If the vent is blocked, the cooling performance of the freezer deteriorates.

4. Leveling feet: These are screw bolts used to secure and level the unit. Adjust the height of the leveling feet by turning them until the two front casters are away from the floor (page 13).

5. Caster: Four casters are provided to facilitate moving of the freezer. For the installation, adjust the leveling feet so that the two front casters cannot contact the floor.

6. Condenser filter (behind the grille): Prevents the dust from accumulating on the condenser. A dusty condenser filter may cause a failure of the freezer. Clean the condenser filter once a month (page 89).

7. Access ports (rear and bottom): Used to route the sensor/cable of measuring equipment or the nozzle of the backup cooling system (optional) into the chamber.

Note: Be sure to put back the cap and insulation for the access ports after using the access ports. If they are not attached properly, the chamber temperature may not reduce, or condensation may occur outside the access ports.

8. Auto air intake port: When the outer door is closed, this port takes in the outer air and the pressure difference between the inside and outside of the chamber is automatically adjusted. So, the outer door can be opened easily. While this port is working, you will hear the suction noise, but this is not a malfunction.

9. Power/Alarm lamp (LED): When the power to the unit is ON, the green lamp illuminates. When the unit is in the Alarm condition, the red lamp blinks. When the unit is in the Notice condition, the orange lamp blinks (pages 86 - 87).

10. USB ports (at the lower part of the control panel and right side of the unit): USB flash drives are inserted into these positions when exporting log data, user account data, or freezer setting data and when importing user account data or freezer setting data. Also, these ports may be used for future enhancements. If USB flash drives are inserted into both ports, the port at the lower part of the control panel has a priority.
Note: USB flash drives with a capacity of 32 GB or less that employ the FAT16/FAT32 file system are supported. USB flash drives that require passwords cannot be used. Do not insert devices other than USB flash drives into the USB ports.

11. Power switch: Power switch for the freezer unit (ON="I", OFF="O").

12. Battery switch for power failure alarm: Switch for turning ON/OFF the battery for power failure alarm. Always turn this switch on when the unit is operating to ensure that the power failure alarm is working. Turn this switch off when the unit is not used for a long period in order to protect the battery.

13. Power supply cord: MDF-DU703/503VH-PA (und detachable), MDF-DU703/503VHA-PA (detachable) Do not disconnect the power supply plug or the product side plug (inlet part) carelessly. If the power supply cord is disconnected, the contents of the chamber may be deteriorated.

* When the optional backup cooling system is installed:

14. Backup test switch (TEST)*: Used to check that the backup cooling system can inject liquid CO₂ (page 96).



15. Backup power switch (BACKUP)*: Power switch for the backup cooling system (page 96).

16. Temperature setting knob (TEMP. SET)*: Used to set the injection start temperature of the backup cooling system (page 96).

FREEZER COMPONENTS

Accessories

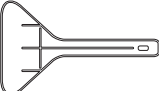
Check that following accessories are included with this unit. If any accessories are missing, contact our sales representative or agent.

Name	Qty	Appearance	Usage
Key	1 set		For opening the outer door manually in the event of a power failure (page 58).
Scraper	1		For removing frost in the chamber (page 90).
Shelf stopper	12		For securing the shelves in the chamber (page 13).

Remote alarm terminals

The alarm condition of the freezer can be transferred to a remote location by connecting an external alarm device (commercially available) to the remote alarm terminals. Especially, the use of the remote alarm device is recommended if the freezer is placed in an unattended environment to ensure that alarm condition is notified to the administrator. For installing the alarm device, contact our sales representative or agent.

The terminals for the remote alarm are provided at the right side of the unit (see the right figure). Alarm signals are transmitted from these terminals as non-voltage contact outputs. Contact capacity is DC 30 V, 2 A.

Table 1 shows the terminal status and the behavior of the remote alarm when the Buzzer Stop button is tapped.

Note:

- For the door alarm, remote alarm function does not activate (page 86).

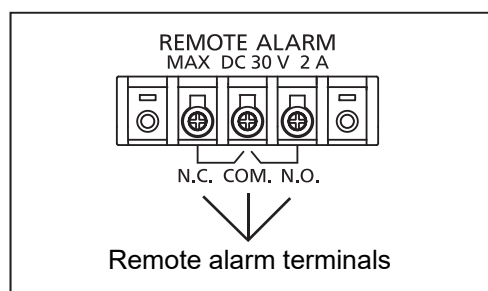

Table 1 Terminal status and behavior of remote alarm when Buzzer Stop button is tapped

"Remote Alarm" setting (page 61)	Connection terminal	Normal condition	Abnormal condition (Including in the event of power outage and when power plug is pulled out.)	
			When Buzzer Stop button is tapped	
ON: Not linked with Buzzer Stop button	COM.-N.C.	Close	Open	Open (indicates abnormal condition)
	COM.-N.O.	Open	Close	Close (indicates abnormal condition)
OFF: Linked with Buzzer Stop button	COM.-N.C.	Close	Open	Close (goes back to normal condition)
	COM.-N.O.	Open	Close	Open (goes back to normal condition)

Notes:

- For the types of alarms that can be transferred to the remote alarm device, refer to pages 86 and 87.
- Use a commercially available alarm device when using the remote alarm function. Making a new device or remaking an existing device yourself may cause an electric shock or malfunction.
- When connecting an alarm device to the remote alarm terminals, turn off the power switch and unplug the freezer. Otherwise, it may cause an electric shock.
- Use shielded wire for connection. A maximum length of 30 meters of the cable is recommended.

START-UP PROCEDURE

Follow the procedure below to start test run or start operation of this product.

Preparation

1. Check that the following switches at the lower right side of the unit are turned off: power switch, battery switch for power failure alarm, backup power switch (if the optional backup cooling system is installed).

Note: Power failure alarm will activate if the battery switch for power failure alarm is turned on when the power to the freezer is off.

Start-up

2. Without putting anything into the chamber, connect the power supply cord to the dedicated outlet.

3. Turn on the power switch for the unit to start freezer operation.

Setting after start-up

4. Turn on the battery switch for power failure alarm.

Note: When the battery switch for power failure alarm is OFF, the freezer is in the notice status. For details about the notice status, refer to the N22 description on page 87. The status returns to normal when the battery switch for power failure alarm is turned on.

5. Set the desired chamber temperature set point and high and low temperature alarms (page 59).

Note: Keep the ambient temperature 5°C to 30 °C. The chamber temperature may not reach to the set point if the ambient temperature exceeds 30 °C.

Check

6. Check that the chamber temperature has cooled to the set point by looking the temperature displayed on the Home screen.

7. Perform the alarm test. Check that the alarm activates properly by following the instruction about alarm test on page 61.

Setting optional device function

8. Turn on the backup power switch for the optional backup cooling system (if installed).

Note: When backup power switch is off, the backup cooling icon is displayed in orange. This icon turns white when the backup power switch is turned on (page 96).

9. Press the backup test switch for the optional backup cooling system (if installed) to check if it works properly (you can hear a slight injection sound).

Note: If the backup cooling system is not charged enough when this product is turned on for the first time or this product is not used for a long time, the backup cooling kit may not work properly. In this case, charge the backup cooling system by running the freezer for more than 6 hours. For fully charging the completely discharged backup cooling system, the freezer should run more than three days.

10. Set the injection start temperature of the backup cooling system (if installed) using the temperature setting knob (TEMP.SET).

11. Put the samples into the chamber little by little.

◆ Putting a large volume of samples into the chamber at a time causes the temperature to rise rapidly.

◆ Putting too many high temperature items into the chamber may rise the chamber temperature causing the samples to deteriorate.

12. Configure settings (alarm setting, security mode, etc.) as necessary.

Notes:

- When closing the outer door, push the handle towards the cabinet side until the latch is engaged. Insufficient pushing can cause temperature rise in the chamber.
- In case some optional inventory racks are in the chamber, be careful not to drop inventory rack when pulling it out.

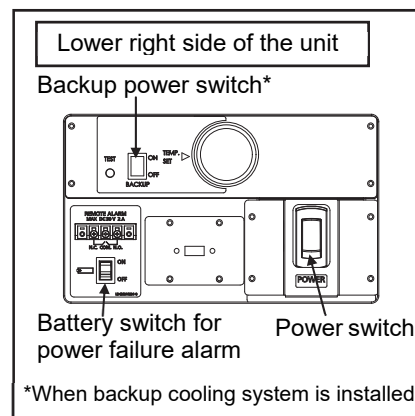

START-UP PROCEDURE

Operation during power failure

When the battery switch for power failure alarm is ON, the unit behaves as follows even during a power failure.

- The power failure alarm activates (page 86).*
Tap the Buzzer Stop button to silence the sound of the power failure alarm. If the ring back is turned ON, the audible alarm sounds again when a power failure still continues after ring back set time elapsed (page 60).
- The power/alarm lamp (LED) blinks in red.*
- LCD touch panel becomes dark.
By touching the LCD touch panel, it becomes brighter for 5 seconds.*
- The High/Low alarm can activate even during a power failure (pages 59 and 86).
When High/Low alarm activates, an alarm message is displayed on the message display area. At this point, the audible alarm and the remote alarm have activated, and the status indicator and the power/alarm lamp has been turned red since the power failure alarm has already activated.
- The clock does not stop.
- Event log data and operation log data during a power failure is saved.*

*When the battery is flat, these functions do not work.

Operation after recovery from power failure

During a power failure, the setting values are stored in the nonvolatile memory. Therefore, after the power comes back, the freezer resumes the operation using the setting values before the power failure. Reconfiguration for setting values is not required but check the settings such as operation settings and alarm settings. If the settings have been changed for some reasons, stored items inside the unit may be adversely affected after the operation resumes.

In order to notify the user that a power failure has occurred, the alarm status continues even if the freezer resumes its operation after the power failure. That is, the audible alarm sounds, the status indicator blinks in orange, and “Buzzer Stop” is displayed in the center of the Buzzer Stop button. Tapping the Buzzer Stop button stops the sound and clears the “Buzzer Stop” indication. Also, the event log button in the sidebar menu indicates that there is information that the user should acknowledge . To check the power failure log, tap the event log button (page 72).

Notes:

- In case of power failure, take appropriate measures to protect the valuable samples following the tips described on pages 10 and 11.
- It may take up to 1 minute until the LCD touch panel turns on after the power comes back.
- If multiple freezers are used, all of the freezers will start up at the same time after the power comes back. This will lead to a temporary voltage drop and may affect the starting of the freezers. To prevent this situation, set the appropriate compressor delay time for the freezers (page 61).

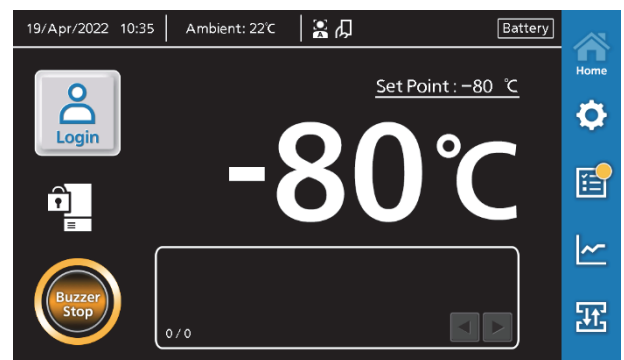

2. TOUCH PANEL OPERATION

USING THE TOUCH PANEL

For controlling the freezer, the LCD touch panel is provided at the front of the freezer.

Basic Operation

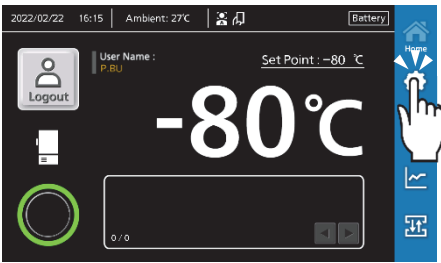
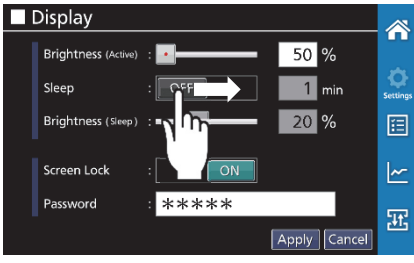
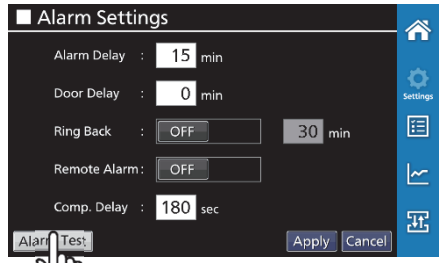
Tap Lightly touch the screen with your finger and immediately release the finger from the screen.	Slide With lightly touching the screen with your finger, move to the destination and then release the finger from the screen.	Long tap Lightly touch the screen for a few seconds and then release the finger from the screen.
		

Notes:

- Use your finger or a capacitive stylus pen to protect the screen.
- Do not use sharp pointed hard items such as the tip of a ballpoint pen for touching the screen.

Entering alphanumeric values and dates

Entering numerical values:

1. Tap the numeric input field.
▶ The numeric input window is displayed.

Numeric input fields

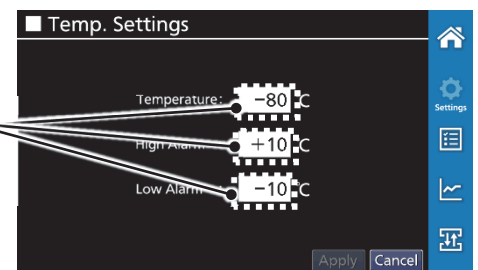

2. Tap the numeric keys or Up/Down keys to input a numerical value.

Details of keys in the numeric input window

- Numeric keys (0~9): Input numbers directly.
- Up/Down keys (▲/▼): Increase or decrease the numerical value displayed in the numeric input field.
- Clear button: Deletes the numerical value displayed on the numeric input box.

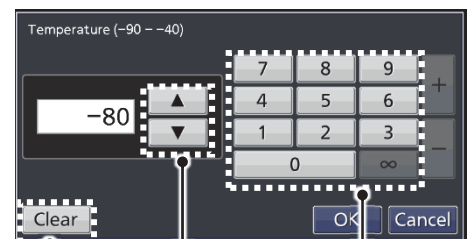

Clear button Up/Down keys Numeric keys

3. Tap the OK button.

USING THE TOUCH PANEL

Entering alphanumeric characters and symbols:

1. Tap the alphanumeric input field.
 - ▶ The alphanumeric input window is displayed.

Alphanumeric input field

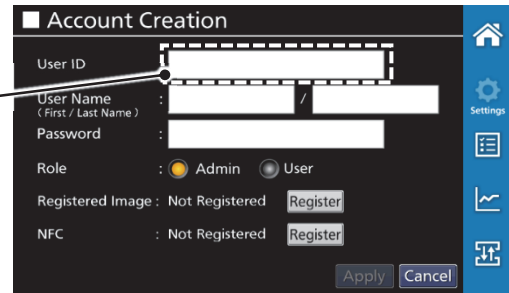

2. Tap the alphabetic keys, numeric keys, or symbol keys to enter alphanumeric characters and symbols.
 - ▶ The input windows can be switched using the <Aa@> button. The screen switches in the order of the uppercase letters/numbers window → lowercase letters/numbers window → symbols window.

[Uppercase letters, numbers]



[Lowercase letters, numbers]



[Symbols]



Details of keys in the alphanumeric input window

- Alphabetic keys (A to Z, a to z, Space): Input alphabetic characters or spaces.
- Numeric keys (0 to 9): Input numbers.
- Symbol keys: Input symbols
- Left/Right buttons (◀/▶): Move the cursor to the left/right.
- Delete button: Deletes an alphanumeric character or symbol immediately to the left of the cursor.

3. Tap the OK button.

Entering date and time:

1. Tap the date input field or time input field.
 - ▶ The input window is displayed.

Date input field

Time input field

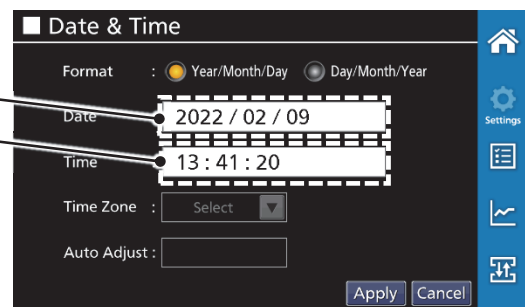

2. Tap the ▲/▼ buttons to enter the values.

Note:

The time is expressed using a 24-hour clock.

3. Tap the OK button.

[Date] Year/Month/Day



[Date] Day/Month/Year

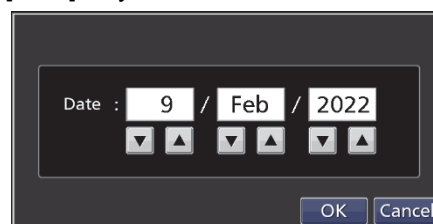

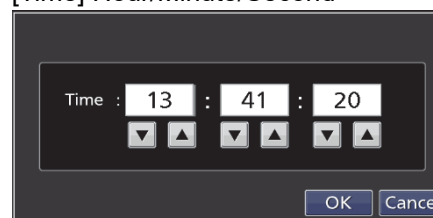

[Time] Hour/Minute/Second



Other operations

1. Common button operation on the touch panel:

Button	Name/Details
	OK button Confirm the selected setting and return to the previous screen (the setting has not been saved yet).
	Apply button Apply and save the setting into the unit and return to the previous screen.
	Cancel button Cancel the selected setting and return to the previous screen.

2. Auto return function

When there is no touch panel operation for about 90 seconds on screens other than the Home screen, the display automatically returns to the Home screen. Therefore, when you are in the middle of setting some values and do not touch the screen for more than about 90 seconds, the screen returns to the Home screen without storing the halfway setting data.

Notes:

- When the sleep function is set to ON (page 67) and there is no touch panel operation for about 90 seconds without any alarm or error in the sleep state, the display automatically returns to the Home screen.
- When the security mode is set to ON (pages 26-28) and there is no touch panel operation for the time specified at Auto Logout (Time) in the Security Settings screen, the auto return function works.

3. Auto logout function (Security mode)

When a user is in a logged-in state and there is no touch panel operation for the period specified at Auto Logout (Time) in the Security Settings screen, the screen returns to the Home screen and the user is automatically logged out after 5 seconds. For the setting of the auto logout time, refer to No.7 on page 52.

HOME SCREEN

The following screen is displayed on the LCD display after turning on the power switch for the freezer. This screen is called as “Home screen” and shows basic information about the status of the freezer. It will take about 20 seconds before the Home screen is displayed after turning on the power switch.

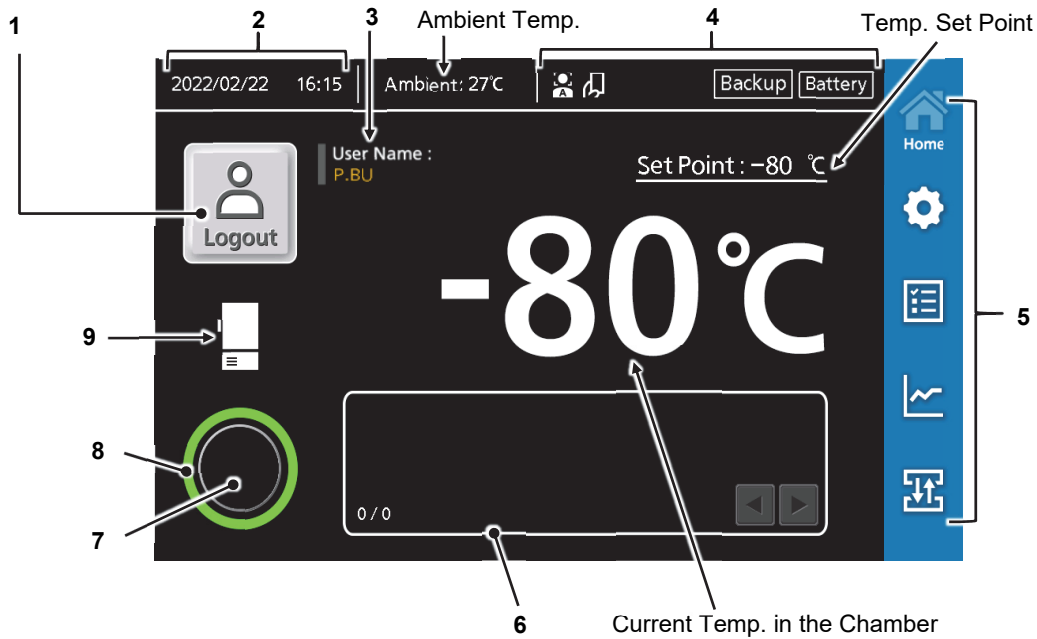

1. Login/Logout button

When the security mode is set to ON, a user can log in to or log out the freezer using this button. When the security mode is set to OFF, this button does not appear (Fig.1).



Tap this button to display the login screen.



Tap this button to log out (lock) when the outer door is closed.

2. Current date and time

The date and time has been temporarily set at the factory.

3. Logged-in user name

The name of the user currently logged in when the security mode is set to ON. The name is indicated by the first initial and last name.

4. Status icon

The statuses of some functions are indicated.

Icon	Name/Details
	Face recognition icon This icon is displayed when the security mode is set to ON and the face recognition function is set to ON.
	Auto face recognition icon This icon is displayed when the face recognition function is set to “Auto.” This icon blinks during the recognition process. The auto face recognition function does not work for about 20 seconds immediately after logging out to prevent the incorrect operation. During this period, the icon turns gray.
	NFC icon This icon is displayed when the security mode is set to ON and optional NFC reader is installed and set to ON.

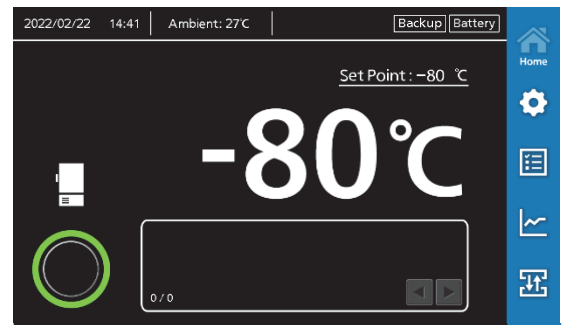



Fig.1 Home screen with the security mode set to OFF

Icon	Name/Details
	Backup cooling icon This icon is displayed when the optional backup cooling system is installed. The icon is white when the backup power switch (BACKUP) is turned on. The icon turns orange when the BACKUP switch is turned off.
	Battery for power failure alarm icon The icon is white when the battery for power failure alarm is turned on. This icon turns orange when the battery for power failure alarm is turned off.

5. Sidebar menu

Using the buttons in the sidebar menu, you can switch the screens for setting values or referring to the information of the freezer. For details about each button, refer to pages 24 and 25.

6. Message display area

Alarm or notice information is displayed.

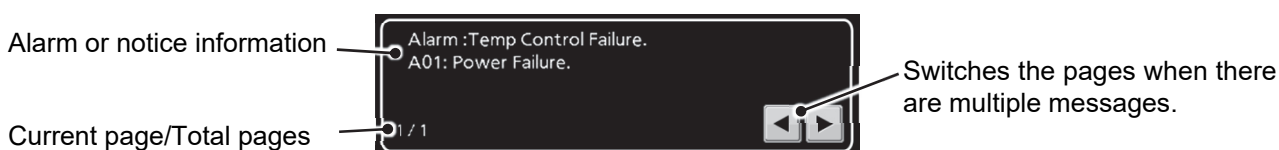

7. Buzzer Stop button

When the audible alarm sounds, “Buzzer Stop” is displayed in the center of the Buzzer Stop button. Tap this button to stop the sound. If the ring back function is set to ON and the alarm status still continues after the ring back set time elapsed, the audible alarm sounds again (pages 60 and 88).





8. Status indicator

The status of the freezer is indicated by the following indicator ring color.

Color	Status	Details
Green	Normal	No abnormality.
Orange	Notice	Cooling performance may have degraded or there is a possibility of failure other than the cooling performance. When the temperature change is temporarily resulting from user operation, wait for the recovery of chamber temperature. In other cases, if the status is left unsolved, the freezer may malfunction, the chamber temperature may rise, or alarms may not activate. Contact our sales representative or agent.
Red	Alarm	The cooling performance has significantly degraded. Thus, the chamber temperature may get considerably higher. Take some measures to protect the stored samples immediately (e.g. transferring the stored samples to another freezer) except when the cause is clear and the chamber temperature can recover soon. Turn off the power switch and contact our sales representative or agent.

9. Outer door status icon

Icon	Details
	The outer door is open.
	The outer door is closed and not electrically locked.
	The outer door is closed and electrically locked.

SIDEBAR MENU BUTTONS

Using the buttons in the sidebar menu, you can switch the screens for setting values, referring to information of the freezer, or importing/exporting data.

1. Home button



Tapping this button on the screens other than the Home screen returns to the Home screen.

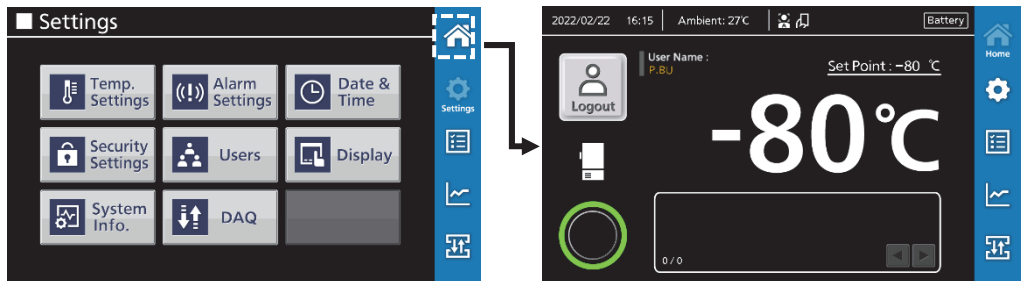

2. Settings button



Tapping this button displays the Settings screen where various settings such as temperature set point, alarm, security mode can be configured.

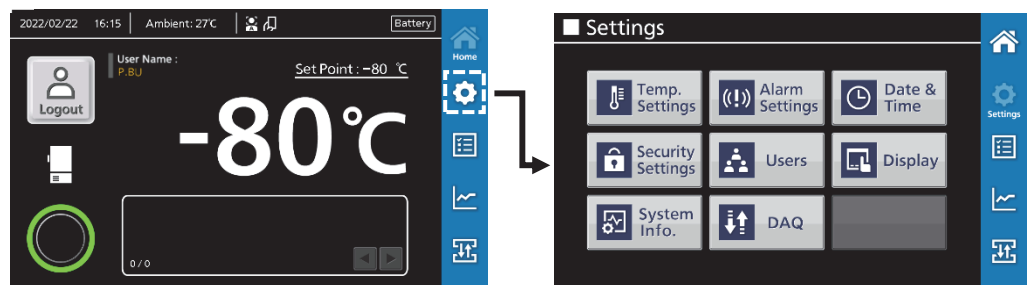

Buttons in the Settings screen	Details	Page
Temp. Settings	Temperature set point setting, high and low alarm setting	59
Alarm Settings	Alarm setting, compressor delay time setting	60, 61
Date & Time	Date and time setting	66
Security Settings	Enable/disable security mode, login method setting, answerback sound setting, auto logout setting	26-29 50-58
Users	User account management	30-49
Display	Display setting, screen lock setting	62-65, 67
System Info.	Information of the model No.and serial No., unit name setting	68
DAQ	DAQ setting	69

3. Event log button



Tapping this button displays the Event Log screen where you can check event log data* saved in the unit and can export the data to a USB flash drive.

*Event log data: Alarm/Notice messages, door openings, login/logout, setting button access, boot/alarm test logs, and information to be acknowledged (pages 70-75).

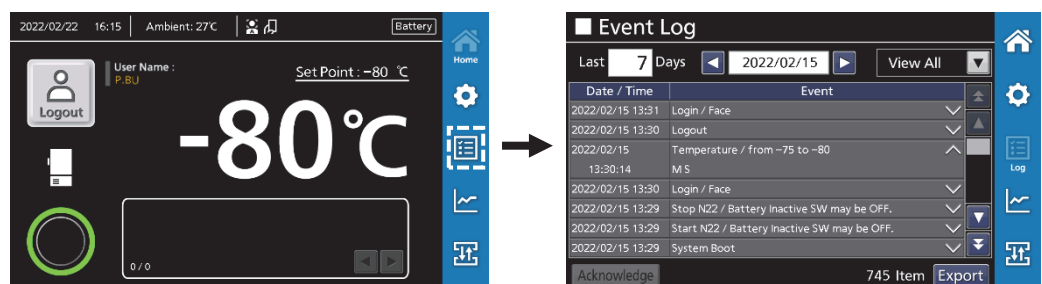

4. Chart button



Tapping this button displays the Chart screen where the charts of the chamber temperature log data and door opening log data can be shown. Also, such log data can be exported to a USB flash drive on the Chart screen (pages 76-78).

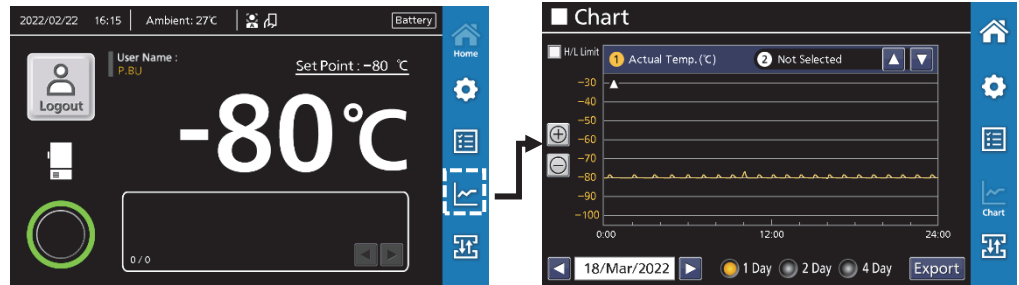

5. Import/Export button



Tapping this button displays the Import/Export screen where you can export log data, or import/export user account data or freezer setting data (pages 79-85).

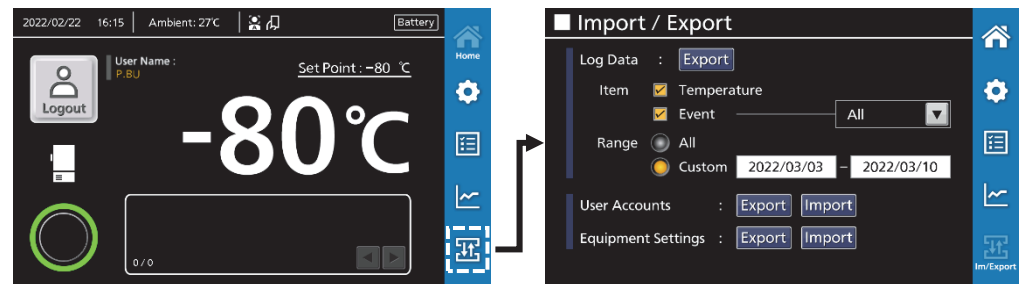

Notes:

- When you are in the middle of configuring settings, if another sidebar menu button is tapped before applying the set data, the confirmation message that asks you whether you want to leave the screen without saving the data is displayed. If “Yes” is selected, the setting is not saved and the top screen for the selected sidebar menu button is displayed. If “No” is selected, you can continue the configuration.
- If the Settings button or the Import/Export button is tapped when the security mode is set to ON and you are not logged in, the Information message that prompts the user to log in is displayed. Tap the OK button and log in to the freezer.

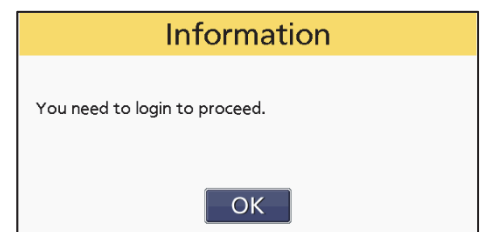
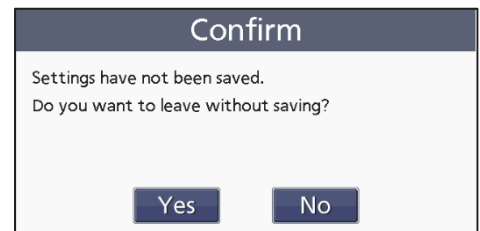

3. SECURITY MODE

SETTING SECURITY MODE

Introduction to the security mode

This product can provide enhanced security when the operation mode called as “security mode” is set to “ON.” In the security mode:

- 1). The outer door can be automatically locked by the electric lock system. It can be unlocked using the face recognition function^{*1}, passwords, or NFC authentication (when the optional NFC reader is installed).
- 2). Freezer control can be restricted by creating user accounts (administrator users (Admin) and general users (User)) to which access rights^{*2} are granted. Administrator users can perform administrative control such as creation of user accounts and configuration of settings. In most cases, general users cannot perform such administrative control.

Access control when using the security mode

	Security Mode	
	ON	OFF
Electrically lock/unlock the outer door	Yes	No
Restrict operations by each role	Yes	No (any user can operate)

To use the security mode, you need to set the security mode to ON (pages 27-28), create user accounts (pages 30-35), and configure the electric lock (Login/Logout method) settings (pages 50-58).

*1 About face recognition function

- The face recognition technology employed in this freezer does not guarantee perfect identification.
- PHC Corporation shall not be responsible for any damages caused by the use of the face recognition function or inoperative face recognition function.
- When security is prioritized, it is advised to turn off the face recognition function and use the password or NFC authentication (when the optional NFC reader is installed).

*2 About access right

The access rights granted to the Admin and User roles are as follows.

Operation	Access right		
	Admin	User	
See setting values	Yes	Yes	
Set, change, import/export of setting values	Yes	No	
See user account information	Yes (All user accounts)	Yes (Only own account)	
Delete user accounts	Yes (All user accounts)	No	
Import/export user account data	Yes (All user accounts)	No	
Create/change user account	Create User IDs	Yes (All user accounts)	No
	Change user IDs	No	No
	Create user names	Yes (All user accounts)	No
	Change user names	Yes (All user accounts)	Yes (Only own account)
	Create roles	Yes (All user accounts)	No
	Change roles	Yes (All user accounts except own account)	No
	Create passwords	Yes (All user accounts)	No
	Change passwords	Yes (All user accounts)	Yes (Only own account)
	Register, change, and delete face recognition data	Yes (Only own account)	Yes (Only own account)
Register, change, and delete NFC cards/devices	Yes (All user accounts)	Yes (Only own account)	
See operation log chart	Yes	Yes	
Export operation log chart data	Yes	No	
See event log	Yes	Yes	
Export event log data	Yes	No	

Setting the security mode to ON

Note:

You cannot use the screen lock function (see page 62) and the security mode at a time. Before setting the security mode to ON, turn off the screen lock. Tap the Settings button in the sidebar menu and tap the Display button, and then slide the Screen Lock button to the left to turn off the screen lock function in the Display screen.

1. Tap the Settings button  in the sidebar menu.
 - ▶ The Settings screen is displayed.
2. Tap the Security Settings button on the Settings screen.
 - ▶ The Security Settings screen is displayed.

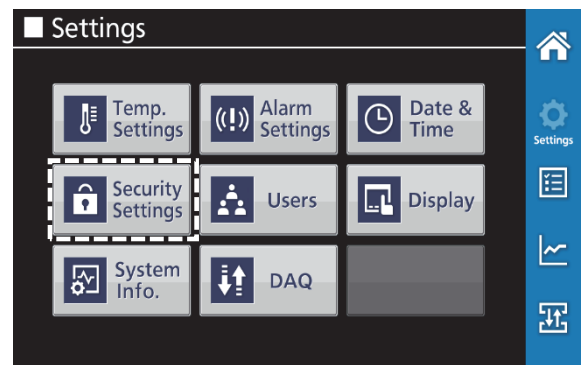
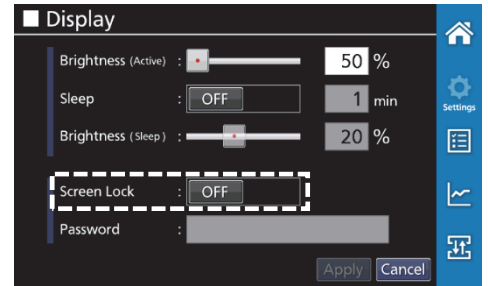

3. Tap the ON radio button at the Security Mode item.
 - ▶ The configuration for other settings such as Login Method, Answerback Sound, and Auto Logout becomes available. For details of these settings, refer to pages 51-52.

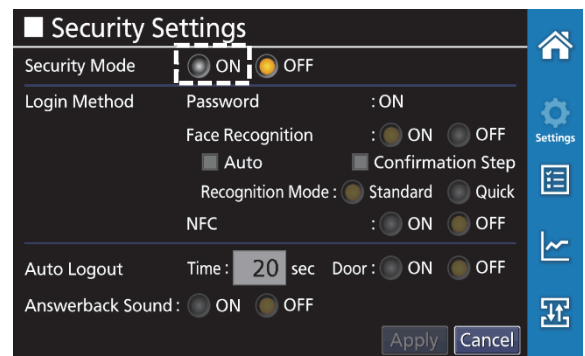

When no accounts are created:

4. Tap the Apply button.
 - ▶ The following Information message that prompts you to create an Admin account is displayed.

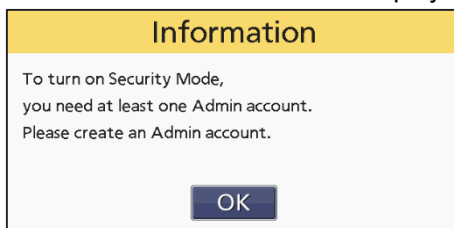

5. Tap the OK button.
 - ▶ The Account Creation screen is displayed.

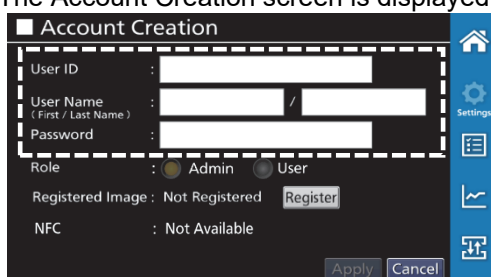

When there is an administrator (Admin) account:

4. Tap the Apply button.
 - ▶ The following Information message that prompts you to log in as an Admin account is displayed.

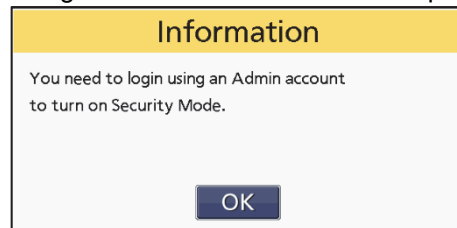

5. Tap the OK button.
 - ▶ The Login window is displayed.



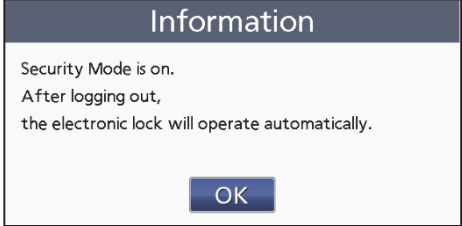
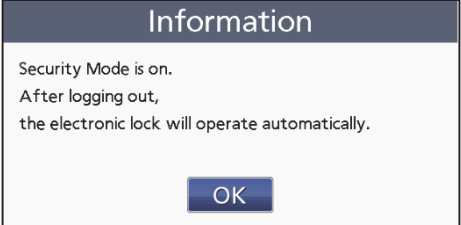
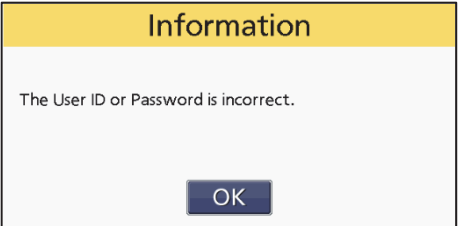
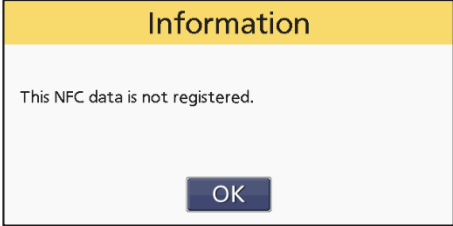

SETTING SECURITY MODE

When no accounts are created:	When there is an administrator (Admin) account:
<p>6. Enter a user ID, user name, and password (see pages 30 and 31), and then tap the Apply button. (Register an image for face recognition function and IC card/NFC device to be used for NFC authentication (when the optional NFC reader is installed) as necessary (for details about registration refer to pages 32-35).)</p> <p>▶ The following Information message informs you that the security mode has been turned on.</p>  <p>Notes:</p> <ul style="list-style-type: none"> • When creating an account for the first time, the “Role” item is fixed to “Admin” and you cannot change the setting (you cannot select the radio button). • If the entry is incorrect, one of the Information messages on page 35 appears. Correct the entry. <p>7. Tap the OK button.</p> <p>▶ The values are saved and the screen returns to the Settings screen.</p>	<p>6. Log in to the freezer using a password or NFC authentication (when the optional NFC reader is installed) (see pages 55 and 56).</p> <p>▶ The following Information message informs you that the security mode has been turned on.</p>  <p>Notes:</p> <ul style="list-style-type: none"> • Face recognition (FaceRecog.) is unavailable. • If you are not recognized, one of the following Information messages is displayed. Tap the OK button and correct the entry. • Incorrect ID or password:  <ul style="list-style-type: none"> • The IC card or NFC device is not registered.  <p>7. Tap the OK button.</p> <p>▶ The values are saved and the screen returns to the Settings screen.</p>

- 8.** Tap the Home button in the sidebar menu.
- ▶ The screen returns to the Home screen.

Setting the security mode to OFF

To set the security mode to OFF, you must log in to the freezer as an administrator role.

1. Tap the Settings button  in the sidebar menu.
 - ▶ The Settings screen is displayed.
2. Tap the Security Settings button  on the Settings screen.
 - ▶ The Security Settings screen is displayed.
3. Tap the “OFF” radio button.
 - ▶ Other setting items become unselectable.

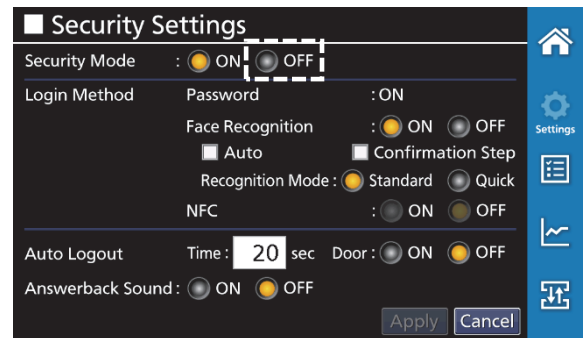

4. Tap the Apply button.
 - ▶ The confirmation message that asks if you want to turn off the security mode is displayed.

5. Tap the “Yes” button.
 - ▶ The security mode is turned off and the screen returns to the Settings screen.

Notes:

- Other settings such as login methods before the security mode is turned off are saved. So, you can use the same setting when you turn on the security mode again.
- If the “No” button is tapped, the screen returns to the Security Settings screen.

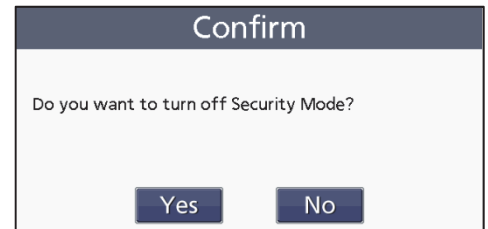

6. Tap the Home button in the sidebar menu.
 - ▶ The screen returns to the Home screen.

ACCOUNT MANAGEMENT BY ADMINISTRATOR

To use the freezer in the security mode, user accounts must be created to register users as administrators (Admin) or general users (User). As described on pages 27 and 28, the first user account (administrator) is created during the steps of setting the security mode to ON. From the second user account onward, only administrators can create user accounts.

Creating a user account

Administrators can create user accounts when they are logged in to the freezer (pages 53-58) when the security mode is set to ON. To create a user account, follow the steps below.

- 1. Tap the Settings button  in the sidebar menu.
▶ The Settings screen is displayed.

Note:

If you are not logging in, the Information message to indicate that you need to log in is displayed. Tap the OK button and log in to the freezer as an administrator.

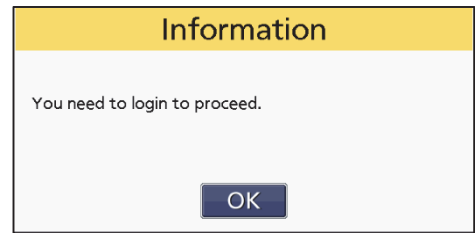

- 2. Tap the Users button on the Settings screen.
▶ The Users screen is displayed.

Note:

On the Users screen, the first names of users that have been entered on the Account Creation screen are indicated by their initials.

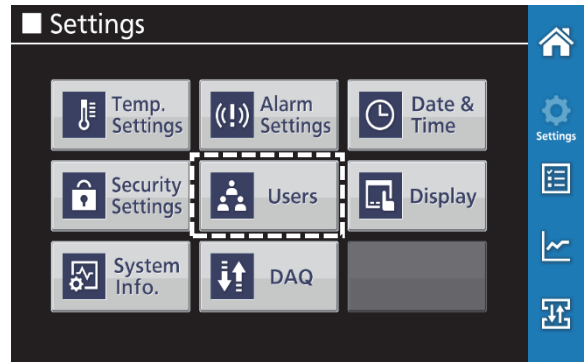

- 3. Tap the Add button.

▶ The Account Creation screen for creating a user account is displayed.

Note:

You can register up to 100 users. When you try to register the 101st user, the following Information message is displayed to notify you that you cannot register any more users. To add more users, delete unnecessary users from the account list (page 41).

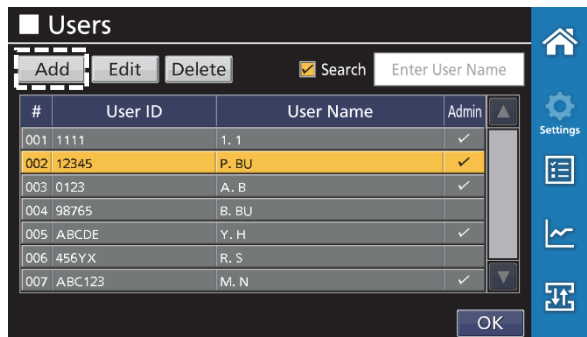
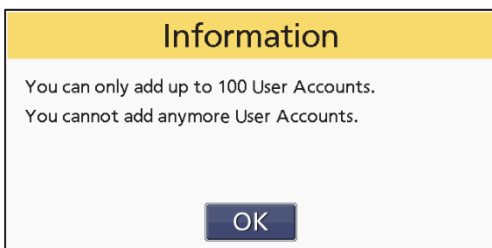



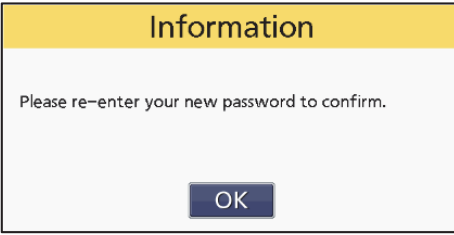
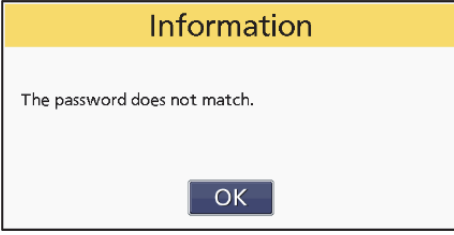

4. Enter each item on the Account Creation screen.

Details of entry

Item	Details	Settable range
User ID	<p>Enter a user ID to be used to log in to the freezer in alphanumeric characters or symbols. Tap the input field and enter the ID (mandatory).</p> <p>Note: If the entered user ID is already registered, the following Information message is displayed. Tap the OK button and enter a different user ID.</p> 	4 to 10 alphanumeric characters or symbols
User Name	<p>Enter a user name (first and last name) in alphanumeric characters or symbols. Tap the input field and enter the name (mandatory). The name is displayed on the Home screen while the user is logging in to the freezer.</p>	1 to 12 alphanumeric characters or symbols
Password	<p>Enter a password to be used to log in to the freezer in alphanumeric characters or symbols. To register the password, you need to enter it twice for confirmation (mandatory).</p> <ol style="list-style-type: none"> Tap the input field. ▶ The alphanumeric input window is displayed. Enter a 4-10 character password and tap the OK button. ▶ The Information message is displayed to ask you to enter the password again. Tap the OK button. ▶ The alphanumeric input window is displayed. Enter the same password as step 2 and tap the OK button. ▶ The screen returns to the Account Creation screen. <p>Note: If the password is not the same one entered in step 2, the following message is displayed. Tap the OK button and follow the steps again from step 1.</p>  	4 to 10 alphanumeric characters or symbols
Role	<p>Select the role of the user to be an administrator (Admin) or a general user (User) by tapping the radio button (mandatory). For the access right granted to each user role, refer to page 26.</p>	Admin/User

ACCOUNT MANAGEMENT BY ADMINISTRATOR

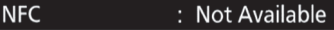
Item	Details	Settable range
Registered Image	<p>An image used for face recognition function can be registered here (optional). Note: For security reasons, every user can register only their own image while they are logging into their account. Therefore, administrators cannot register other users' images when creating other users' accounts.</p> <p>When not registered: </p> <p>When registered: </p> <p>For details about registration of an image for face recognition, refer to steps 5 to 7.</p>	Registered/ Not Registered
NFC	<p>An IC card or NFC device used for NFC authentication (when the optional NFC reader is installed) can be registered here (optional).</p> <p>When not registered: </p> <p>When registered: </p> <p>When not installed: </p> <p>For details about registration of a card or NFC device, refer to steps 8 and 9.</p>	

* Proceed to step 8, if you do not register an image for face recognition function.
 Proceed to step 10, if you do not register an NFC card or device either.

(Optional) Steps for registering an image used for face recognition

5. (Optional) Tap the Register button at the Registered Image item on the Account Creation screen.
 ▶ The Image Registration Setup window is displayed.

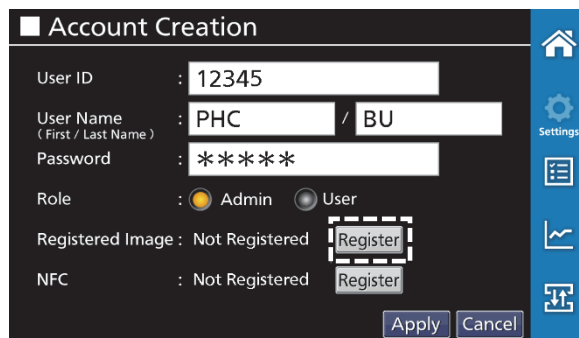

Important

When you try to register an image to be used for the face recognition function for the first time, the consent form for the registration is displayed (not displayed for the second and subsequent time). Read the consent form and also, read the "Ultra Low Temperature Freezer Privacy Policy" included with this product. To agree, tap the checkbox and tap the Agree button. The Image Registration Setup window is displayed. If you tap the Cancel button, the screen returns to the Account Creation screen.

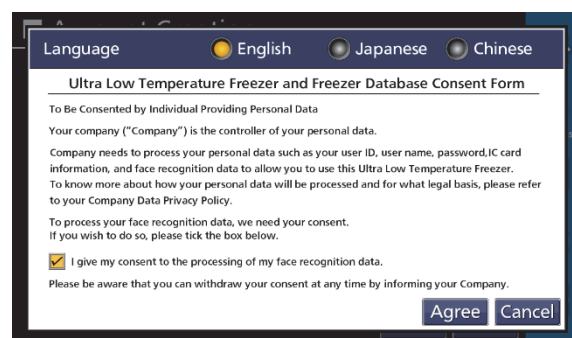

6. (Optional) Face the camera (page 14) and check that you are in the middle of the frame by looking at the image on the left side of the window. Then tap the camera icon () next to the image to take a picture.

▶ The picture taken is displayed on the Registered Image frame on the right side of the window.

If the picture is improper, tap the Retry button to take the picture again.

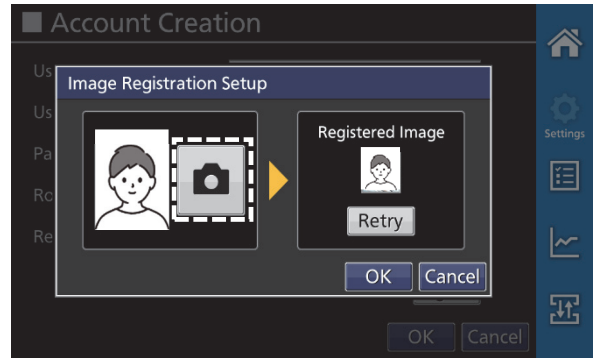

Notes when taking a picture for face recognition

- Face recognition of masked faces is not supported. Remove the mask when taking a picture.
- Face the camera so that your eyes, nose, and mouth are recognized clearly.
- If the user is wearing thick-frame glasses, the face recognition may become less accurate or take more time because part of their eyes is hidden by the frame.
- If the user's hair is hanging over their eyes, or a part of the mouth is covered with their facial hair, or the user is wearing glasses, the face recognition may become less accurate or take more time.

Notes:

- When the camera icon is grayed out, it is unavailable. Tap the icon when it becomes active (white background).

- When the picture is improper, the “Low Score” message is displayed at the bottom of the Image Registration Setup window. Stand at the proper position where the message on the window disappears.

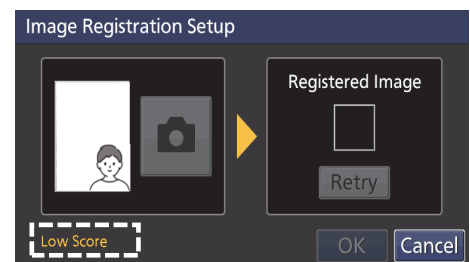

- When multiple people are recognized in the frame, the “Multiple faces have been detected.” message is displayed at the bottom of the Image Registration Setup window. Take the picture alone.

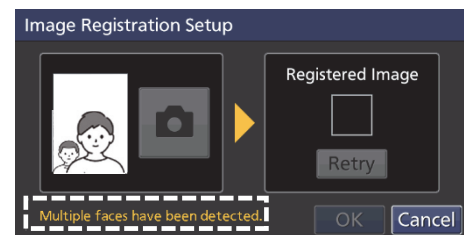

7. (Optional) Tap the OK button.

▶ The Account Creation screen is displayed. The indication at the Registered Image item changes from “Not Registered” to “Registered” and the registration date is displayed. Also, the Register button changes to the Clear button.

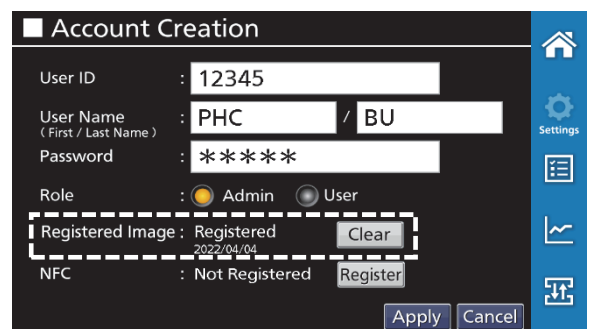

ACCOUNT MANAGEMENT BY ADMINISTRATOR

Note:

If the person in the picture is recognized as the same person who has been already registered, the following information message is displayed. Tap the OK button and retry.

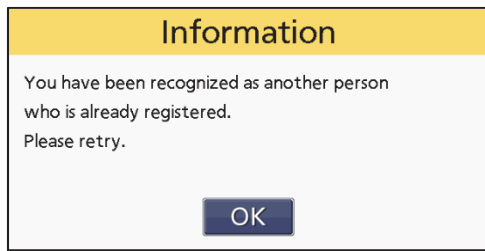

* Proceed to step 10 if you do not register an NFC card or device for NFC authentication (when the optional NFC reader is installed).

(Optional) Steps for registering an IC card/NFC device

Note:

Near-field communication (NFC) is a standards-based short-range wireless connectivity technology. When the optional NFC reader is installed, media conforming to the following communication protocol can be used for authentication.

The reader accepts the media conforming to the following communication protocols.

- JIS X 6319-4 (FeliCa communication system)
- ISO/IEC-14443A
- ISO/IEC-14443B
- ISO/IEC-15693

8. (Optional) Tap the Register button at the NFC item on the Account Creation screen.

► The NFC Registration message prompts you to hold an IC card or NFC device over the NFC reader.

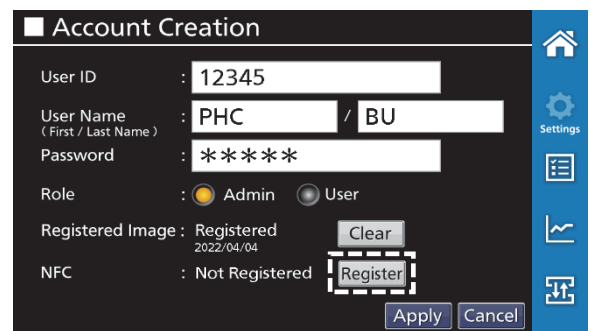
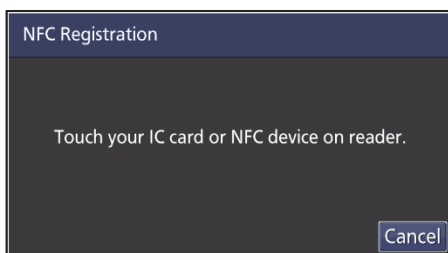

Note:

- If you tap the Cancel button without holding an IC card or NFC device over the reader, the screen returns to the Account Creation screen.

9. (Optional) Hold an IC card or NFC device over the NFC reader.

► Once the registration is completed, the screen returns to the Account Creation screen. The indication at the NFC item changes from "Not Registered" to "Registered." Also, the Register button changes to the Clear button.

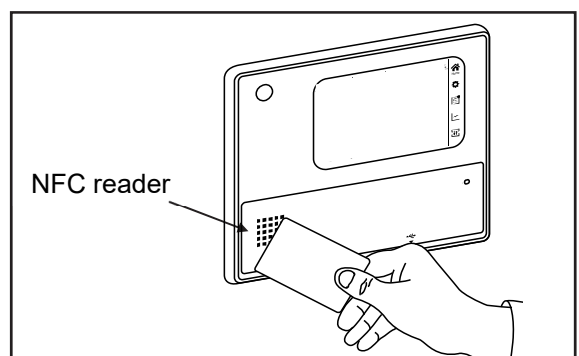

Note:

- If the card or NFC device has been already registered, the following Information message is displayed. Tap the OK button and register a different IC card or NFC device.

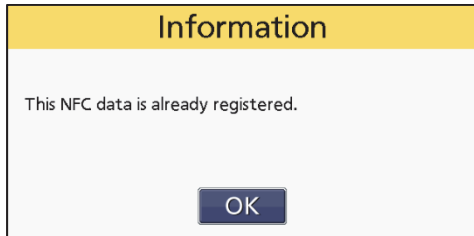

The image shows the 'Account Creation' form. It has a dark background with white text and input fields. The fields are: User ID (12345), User Name (PHC / BU), Password (*****), Role (Admin selected, User unselected), Registered Image (Registered with a date 2022/09/09 and a Clear button), and NFC (Registered with a Clear button). At the bottom right, there are 'Apply' and 'Cancel' buttons. A blue sidebar on the right contains icons for Home, Settings, a list, a graph, and a refresh icon.

- 10.** After necessary information is entered, tap the Apply button.
 ► The values are saved and the screen returns to the Users screen.

Note:

- If the entry is incorrect, one of the following Information messages appears. Tap the OK button and enter correct data.

<ul style="list-style-type: none"> • A user ID less than 4 characters was entered. <p>The dialog box has a yellow header 'Information' and the text 'User ID must be at least 4 characters.' with an 'OK' button at the bottom.</p>	<ul style="list-style-type: none"> • User Name is not entered. <p>The dialog box has a yellow header 'Information' and the text 'Please enter your User Name.' with an 'OK' button at the bottom.</p>
<ul style="list-style-type: none"> • The same user name as a registered user was entered. <p>The dialog box has a yellow header 'Information' and the text 'An account using this User Name already exists. The same User Name cannot be used.' with an 'OK' button at the bottom.</p>	<ul style="list-style-type: none"> • A password less than 4 characters was entered. <p>The dialog box has a yellow header 'Information' and the text 'Password must be at least 4 characters.' with an 'OK' button at the bottom.</p>

- 11.** Tap the Home button in the sidebar menu.
 ► The screen returns to the Home screen.

Note:

Due to unexpected trouble, user account data may be lost. For such an occasion, it is advisable to back up the data regularly by following the steps on pages 81 and 82 to export the data and save it to safe storage.

ACCOUNT MANAGEMENT BY ADMINISTRATOR

Viewing user account list

Administrator can view the list of all user accounts registered on the freezer.

1. Tap the Settings button  in the sidebar menu.
▶ The Settings screen is displayed.

2. Tap the Users button on the Settings screen.
▶ The Users screen is displayed.

Note:

Up to 7 users are displayed in a page. You can scroll up and down the list by tapping the scroll buttons (▲, ▼) to see other users.

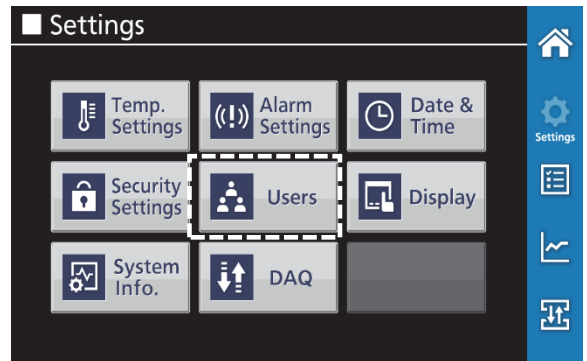

Details of each item

Item	Details
#	Registration number (automatic numbering)
User ID	Registered user ID
User Name	Registered user name
Admin	Marked with ✓ when the user is an administrator.

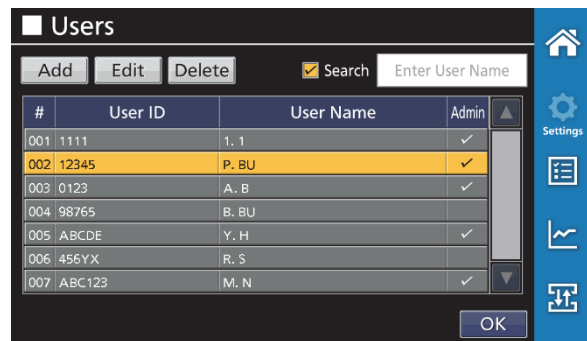

3. Tap the Home button in the sidebar menu.
▶ The screen returns to the Home screen.

About user search function (prefix search)

On the Users screen, you can search for a user by entering their name.

1. Tap the Enter User Name input field at the upper right corner of the screen with the Search checkbox selected.
▶ The alphanumeric input window is displayed.

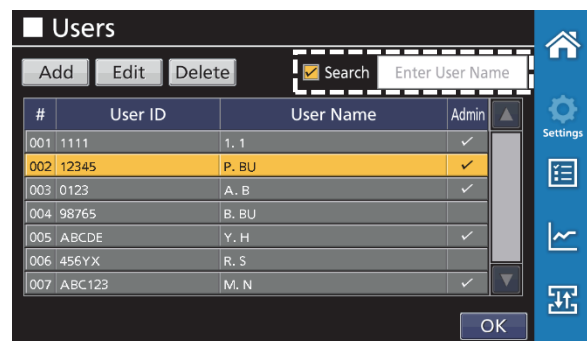

2. Enter the name of the user and tap the OK button.
▶ The search result is displayed.

Note:

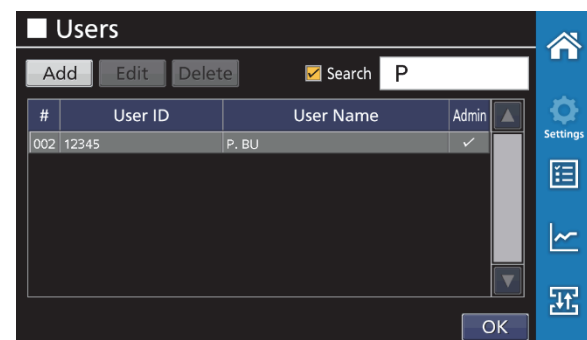

Tapping the Search checkbox to deselect displays all user accounts.

Tapping the OK button returns to the Settings screen.



Changing user account data

Administrators can change users' account data except for user IDs and other users' images. To change user account data, follow the steps below.

1. Tap the Settings button  in the sidebar menu.
▶ The Settings screen is displayed.
2. Tap the Users button  on the Settings screen.
▶ The Users screen is displayed.
3. Tap a user account whose data needs to be changed.
▶ The user account is highlighted in yellow.
Note:
When changing account data, you cannot select multiple users. If other users are selected, tap the users to deselect.
4. Tap the Edit button at the upper part of the Users screen.
▶ The Account Creation screen is displayed.

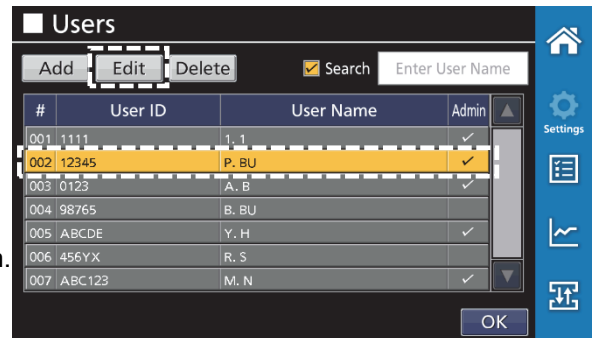

5. Change the data as necessary.

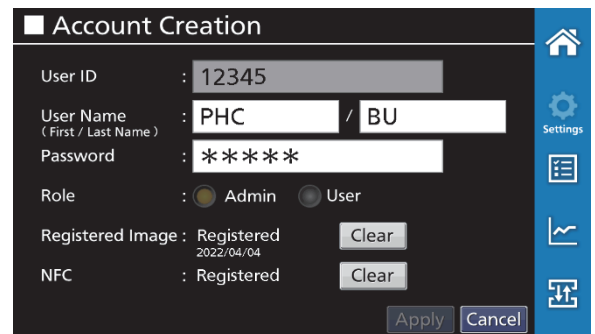

Details of entry

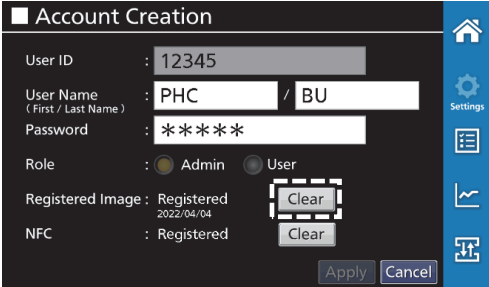
Item	Details
User Name	Tap the input field and change the user name.
Password	Tap the input field and change the password.
Role	Tap the radio button to change the role (Admin or User). Note: Administrator cannot change their own role while they are logging into their account.
Registered Image	<p>Note: Administrator can change only their own image while they are logging into their account.</p> <p>1. Tap the Clear button at the Registered Image. ▶ The Confirm message is displayed to ask you if you really want to delete the image.</p> 

ACCOUNT MANAGEMENT BY ADMINISTRATOR

Item	Details
<p>Registered Image</p>	<p>2. Tap the Yes button. ▶ The registered image is deleted and the indication at the Registered Image item changes from “Registered” to “Not Registered.” Also, the Clear button changes to the Register button.</p> <p>Note: If you tap the No button, the screen returns to the Account Creation screen.</p> <p>3. Tap the Register button at the Registered Image item. ▶ The Image Registration Setup window is displayed.</p> <p>4. Face the camera and check that you are in the middle of the frame by looking at the image on the left side of the window. Then tap the camera icon () next to the image to take a picture. ▶ The picture taken is displayed on the Registered Image frame on the right side of the window. If the picture is not proper, tap the Retry button to take the picture again.</p> <p>Notes:</p> <ul style="list-style-type: none"> • When the camera icon is grayed out, it is unavailable. Tap the icon when it becomes active (white background). • When the picture is improper, the “Low Score” message is displayed at the bottom of the Image Registration Setup window. Stand at the proper position where the message on the window disappears. • When multiple people are recognized in the frame, the “Multiple faces have been detected.” message is displayed at the bottom of the Image Registration Setup window. Take the picture alone.

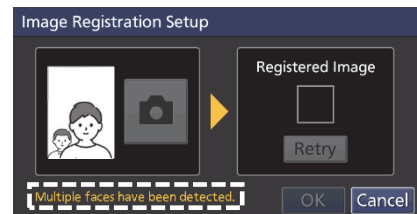
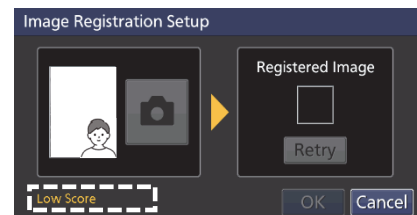
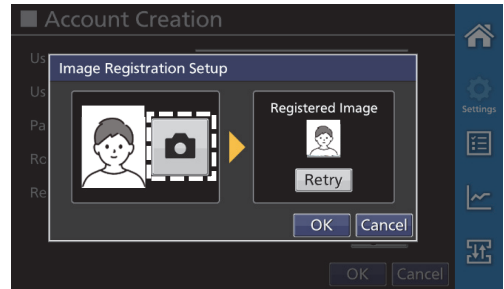
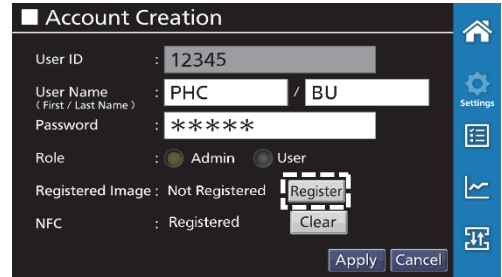

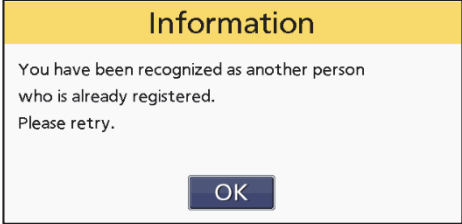
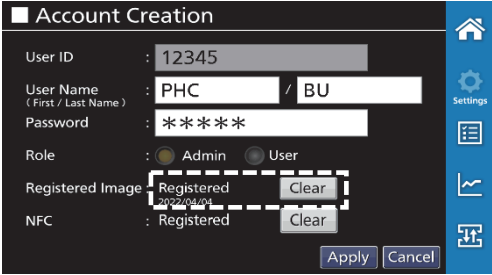
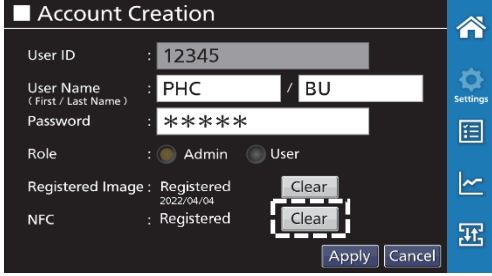
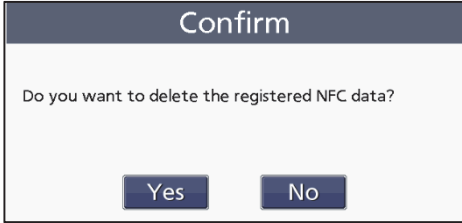
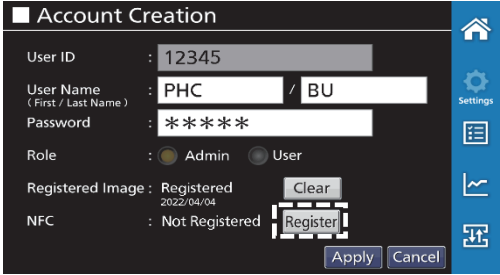
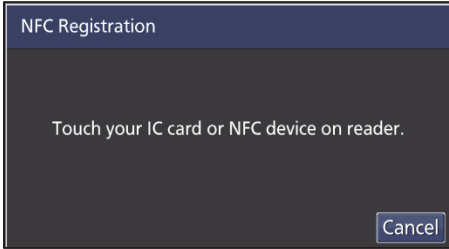
Item	Details
Registered Image	<p>5. Tap the OK button.</p> <p>▶ The indication at the Registered Image item changes from “Not Registered” to “Registered.” Also, the Register button changes to the Clear button.</p> <p>Note: If the person in the picture is recognized as the same person who has been already registered, the following Information message is displayed. Tap the OK button and retake a picture.</p>  <p>The dialog box has a yellow header 'Information' and contains the text: 'You have been recognized as another person who is already registered. Please retry.' with an 'OK' button at the bottom.</p>  <p>The 'Account Creation' screen shows fields for User ID (12345), User Name (PHC / BU), Password (*****), Role (Admin/User), Registered Image (Registered 2022/04/04), and NFC (Registered). The 'Clear' button next to 'Registered Image' is highlighted with a dashed box.</p>
NFC	<p>1. Tap the Clear button at the NFC item on the Account Creation screen.</p> <p>▶ The Confirm message is displayed to ask you if you really want to delete the NFC device registration.</p> <p>2. Tap the Yes button.</p> <p>▶ The registered NFC device is deleted and the indication at the NFC item changes from “Registered” to “Not Registered.” Also, the Clear button changes to the Register button.</p> <p>Note: If you tap the No button, the screen returns to the Account Creation screen.</p> <p>3. Tap the Register button at the NFC item on the Account Creation screen.</p> <p>▶ The NFC Registration message prompts you to hold an IC card or NFC device over the NFC reader.</p> <p>4. Hold an IC card or NFC device over the NFC reader.</p> <p>▶ Once the registration is completed, the screen returns to the Account Creation screen. The indication at the NFC item changes from “Not Registered” to “Registered.” Also, the Register button changes to the Clear button.</p>  <p>The 'Account Creation' screen shows the 'Clear' button next to the 'NFC' field, which is highlighted with a dashed box.</p>  <p>The 'Confirm' dialog box asks: 'Do you want to delete the registered NFC data?' with 'Yes' and 'No' buttons.</p>  <p>The 'Account Creation' screen shows the 'Register' button next to the 'NFC' field, which is highlighted with a dashed box.</p>  <p>The 'NFC Registration' dialog box prompts: 'Touch your IC card or NFC device on reader.' with a 'Cancel' button.</p>

ACCOUNT MANAGEMENT BY ADMINISTRATOR

Item	Details
NFC	<p>Notes:</p> <ul style="list-style-type: none"> • If you tap the Cancel button without holding an IC card or NFC device over the reader, the screen returns to the Account Creation screen. • If the card or NFC device has been already registered, the following Information message is displayed. Tap the OK button and register another IC card or NFC device. <div data-bbox="435 562 885 786" style="border: 1px solid black; padding: 5px; margin: 10px 0;"> <p style="text-align: center; background-color: #FFD700; margin: 0;">Information</p> <p style="text-align: center; margin: 5px 0;">This NFC data is already registered.</p> <p style="text-align: center; margin: 0;"><input type="button" value="OK"/></p> </div> <div data-bbox="954 286 1445 573" style="border: 1px solid black; padding: 5px; margin: 10px 0;"> <p>Account Creation</p> <p>User ID : 12345</p> <p>User Name (First / Last Name) : PHC / BU</p> <p>Password : *****</p> <p>Role : <input checked="" type="radio"/> Admin <input type="radio"/> User</p> <p>Registered Image : Registered <input type="button" value="Clear"/></p> <p>NFC : Registered <input type="button" value="Clear"/></p> <p style="text-align: right;"><input type="button" value="Apply"/> <input type="button" value="Cancel"/></p> </div>

6. Tap the Apply button.



▶ The values are saved and the screen returns to the Settings screen.

7. Tap the Home button in the sidebar menu.

▶ The screen returns to the Home screen.

Deleting a user account

Administrator can delete user accounts by following the steps below.

1. Tap the Settings button  in the sidebar menu.
▶ The Settings screen is displayed.
2. Tap the Users button  on the Settings screen.
▶ The Users screen is displayed.
3. Tap the user accounts that you want to delete (you can select multiple user accounts).
▶ The user accounts are highlighted in yellow.

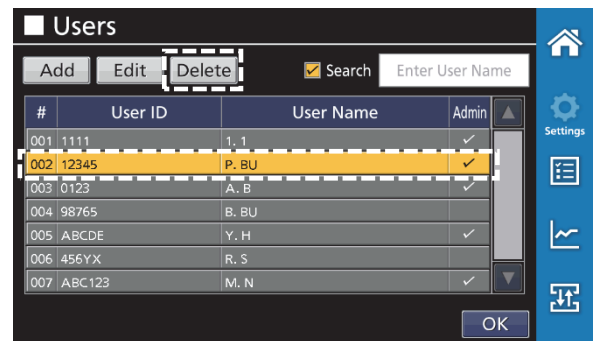

4. Tap the Delete button at the upper part of the Users screen.
▶ The Confirm message is displayed to ask you if you really want to delete the user account.

5. Tap the Yes button.
▶ The Information message notifies you that the account has been successfully deleted.

Note:

If you tap the No button, the screen returns to the Users screen.



6. Tap the OK button on the Information message window.
▶ The screen returns to the Users screen.

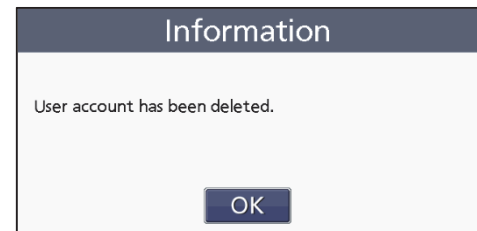

7. Tap the Home button in the sidebar menu.
▶ The screen returns to the Home screen.

Notes:

When you try to delete your own account:

- If there are user accounts other than your own account, the following Information message is displayed to notify you that you cannot delete your own account.

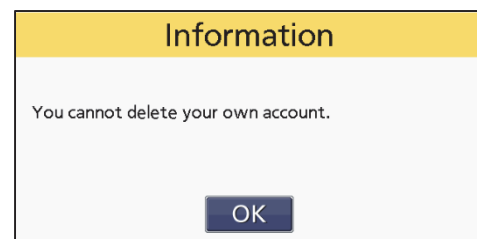

- If there are no user accounts other than your own account, the following Confirm message is displayed to ask you if you want to turn off the security mode.

Tapping the Yes button deletes your user account and sets the security mode to OFF. Then the screen returns to the Settings screen.

Tapping the No button just returns to the Users screen.

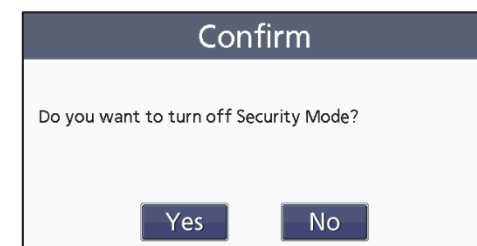

ACCOUNT OPERATION BY GENERAL USER

General users (User) can view and change their own user account information and register their image for face recognition function and an IC card/NFC device to be used for NFC authentication (when the optional NFC reader is installed). These operation can be performed while the security mode is set to ON and they are logged in to their account.

Important

Ask an administrator (Admin) to create a general user's account (creation of user ID, user name, password, and role) because general users cannot create accounts.

Registering a face recognition image and an IC card/NFC device

To register a face recognition image and an IC card or NFC device, follow the steps below (the registration is optional).

1. Tap the Settings button  in the sidebar menu.

▶ The Settings screen is displayed.

Note:

If you are not logging in, the Information message to indicate that you need to log in is displayed. Tap the OK button and log in to the freezer as a general user (User).

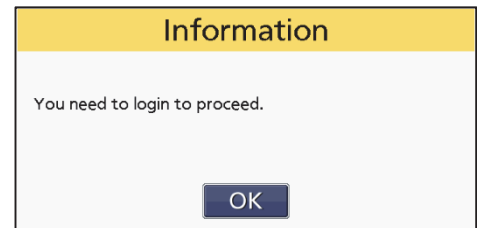

2. Tap the Users button on the Settings screen.

▶ The Account Creation screen is displayed.

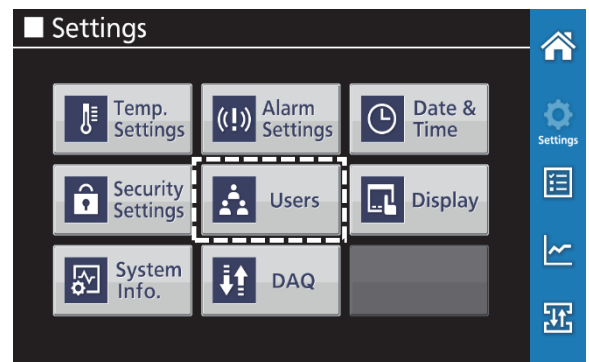

3. Register an image or an IC card/NFC device.

Image registration → Steps 4 to 6

NFC device registration → Steps 7 and 8

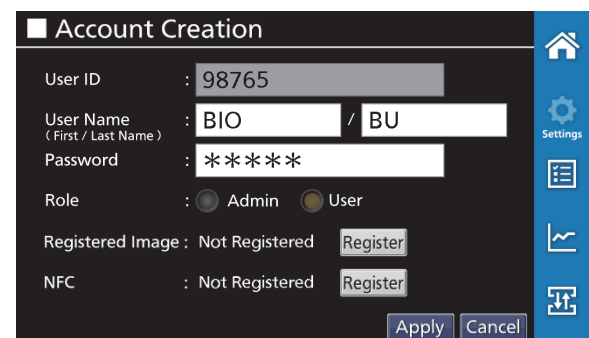

Steps for registering an image used for face recognition

4. Tap the Register button at the Registered Image item on the Account Creation screen.

▶ The Image Registration Setup window is displayed.

Important

When you try to register an image to be used for the face recognition function for the first time, the consent form for the registration is displayed (not displayed for the second and subsequent time). Read the consent form and also, read the “Ultra Low Temperature Freezer Privacy Policy” included with this product. To agree, tap the checkbox and tap the Agree button. The Image Registration Setup window is displayed. If you tap the Cancel button, the screen returns to the Account Creation screen.

5. Face the camera (page 14) and check that you are in the middle of the frame by looking at the image on the left side of the window. Then tap the camera icon () next to the image to take a picture.

▶ The picture taken is displayed on the Registered Image frame on the right side of the window.

If the picture is improper, tap the Retry button to take the picture again.

Notes when taking a picture for face recognition

- Face recognition of masked faces is not supported. Remove the mask when taking a picture.
- Face the camera so that your eyes, nose, and mouth are recognized clearly.
- If the user is wearing thick-frame glasses, the face recognition may become less accurate or take more time because part of their eyes is hidden by the frame.
- If the user's hair is hanging over their eyes, or a part of the mouth is covered with their facial hair, or the user is wearing glasses, the face recognition may become less accurate or take more time.

ACCOUNT OPERATION BY GENERAL USER

Notes:

- When the camera icon is grayed out, it is unavailable. Tap the icon when it becomes active (white background).
- When the picture is improper, the “Low Score” message is displayed at the bottom of the Image Registration Setup window. Stand at the proper position where the message on the window disappears.

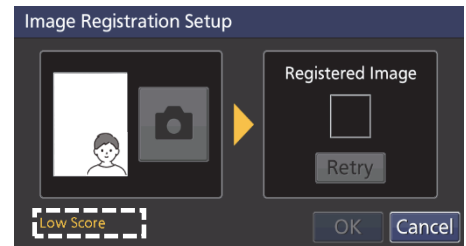

- When multiple people are recognized in the frame, the “Multiple faces have been detected.” message is displayed at the bottom of the Image Registration Setup window. Take the picture alone.

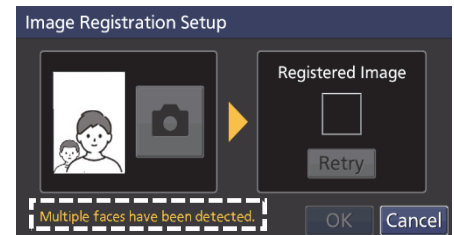

6. Tap the OK button.

▶ The Account Creation screen is displayed. The indication at the Registered Image item changes from “Not Registered” to “Registered” and the registration date is displayed. Also, the Register button changes to the Clear button.

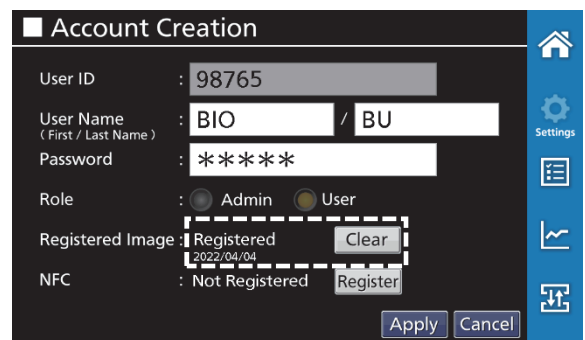

Note:

If the person in the picture is recognized as the same person who has been already registered, the following Information message is displayed. Tap the OK button and retry.

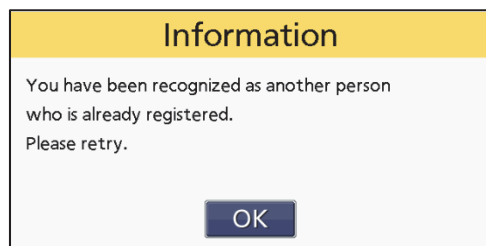

Steps for registering an IC card/NFC device

Note:

Near-field communication (NFC) is a standards-based short-range wireless connectivity technology. When the optional NFC reader is installed, media conforming to the following communication protocol can be used for authentication.

The reader accepts the media conforming to the following communication protocols.

- JIS X 6319-4 (FeliCa communication system)
- ISO/IEC-14443A
- ISO/IEC-14443B
- ISO/IEC-15693

7. Tap the Register button at the NFC item on the Account Creation screen.

► The NFC Registration message prompts you to hold an IC card or NFC device over the NFC reader.

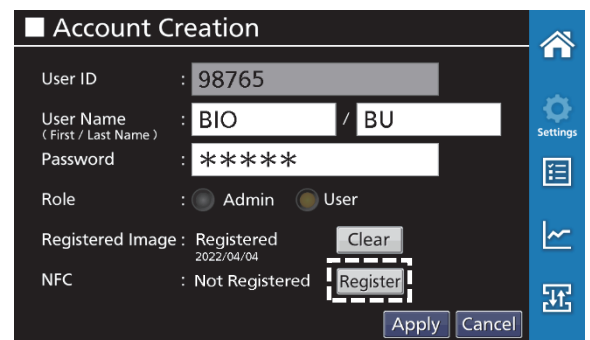
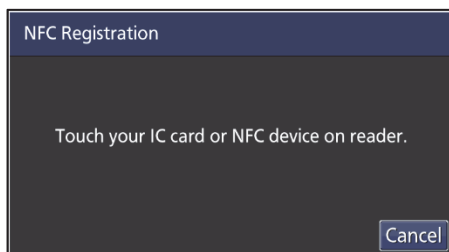

Note:

- If you tap the Cancel button without holding an IC card or NFC device over the reader, the screen returns to the Account Creation screen.

8. Hold an IC card or NFC device over the NFC reader.

► Once the registration is completed, the screen returns to the Account Creation screen. The indication at the NFC item changes from "Not Registered" to "Registered." Also, the Register button changes to the Clear button.

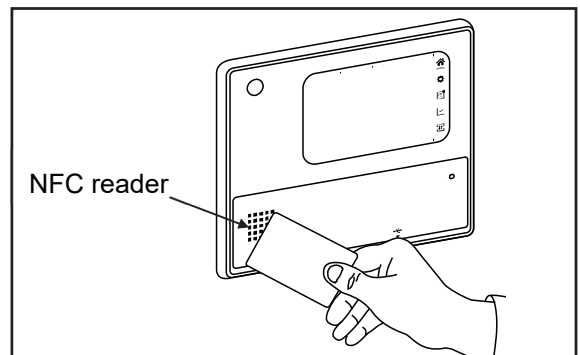

Note:

- If the card or NFC device has been already registered, the following Information message is displayed. Tap the OK button and register a different IC card or NFC device.

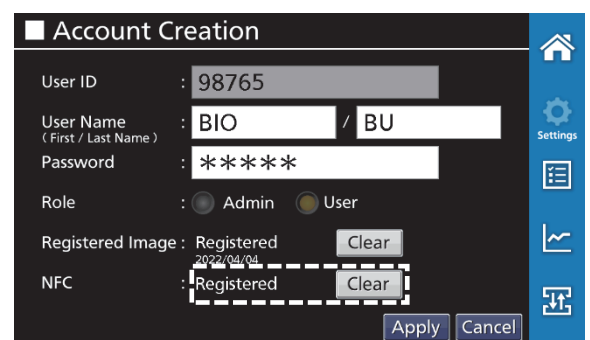
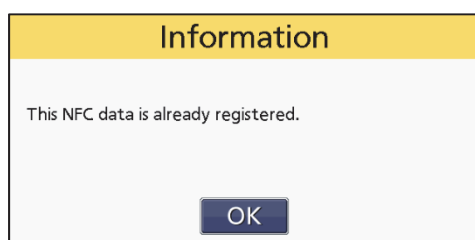

ACCOUNT OPERATION BY GENERAL USER

9. Tap the Apply button.

▶ The data is saved and the screen returns to the Settings screen.

Note:

If an image for face recognition is registered, the registration date appears next time when you open the Account Creation screen.

10. Tap the Home button in the sidebar menu.

▶ The screen returns to the Home screen.

Viewing your account information

General users can view only their own account information.

1. Tap the Settings button  in the sidebar menu.

▶ The Settings screen is displayed.

2. Tap the Users button  on the Settings screen.

▶ The Account Creation screen that shows your account information is displayed.

3. Tap the Home button in the sidebar menu.

▶ The screen returns to the Home screen.

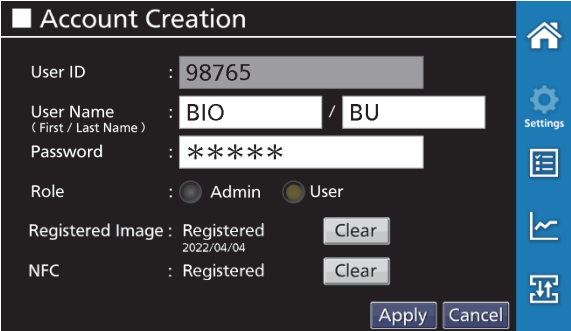

The screenshot shows the 'Account Creation' screen with the following fields and values:

- User ID: 98765
- User Name (First / Last Name): BIO / BU
- Password: *****
- Role: Admin (selected), User
- Registered Image: Registered (2022/04/04) with a 'Clear' button
- NFC: Registered with a 'Clear' button

At the bottom, there are 'Apply' and 'Cancel' buttons. A sidebar menu on the right contains icons for Home, Settings, List, Chart, and Refresh.

Changing user account data

General users can change their own user account data (user name, password, face recognition image, and IC card/NFC device). To change the account data, follow the steps below.

1. Tap the Settings button  in the sidebar menu.

▶ The Settings screen is displayed.

2. Tap the Users button  on the Settings screen.



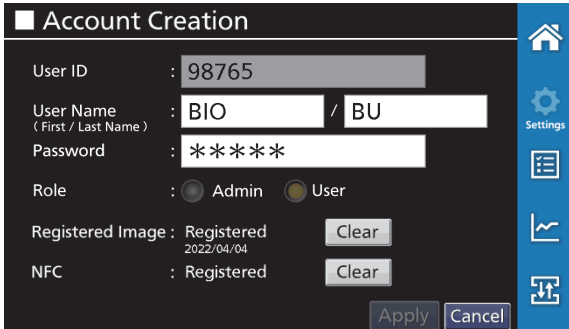

▶ The Account Creation screen is displayed.

3. Change the data as necessary.

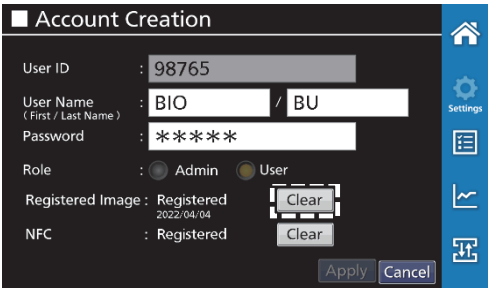

This screenshot is identical to the one above, showing the 'Account Creation' screen with the same fields and values.

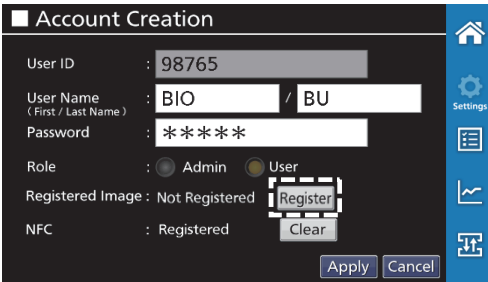
Details of entry

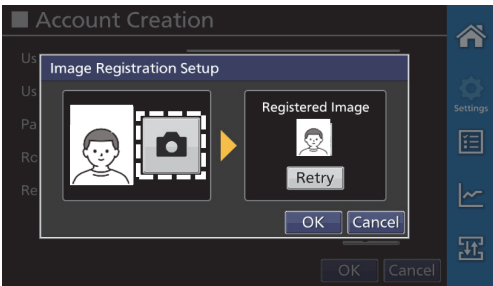
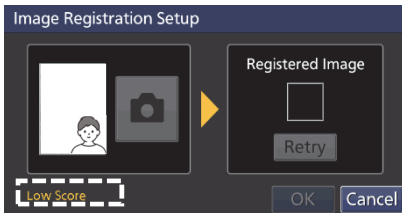
Item	Details
User Name	Tap the input field and change the user name.
Password	Tap the input field and change the password.
Registered Image	<p>1. Tap the Clear button at the Registered Image.</p> <p>▶ The Confirm message is displayed to ask you if you really want to delete the image.</p>  <p>2. Tap the Yes button.</p> <p>▶ The registered image is deleted and the indication at the Registered Image item changes from “Registered” to “Not Registered.” Also, the Clear button changes to the Register button.</p> <p>Note: If you tap the No button, the screen returns to the Account Creation screen.</p>  <p>3. Tap the Register button at the Registered Image item.</p> <p>▶ The Image Registration Setup window is displayed.</p>  <p>4. Face the camera and check that you are in the middle of the frame by looking at the image on the left side of the window. Then tap the camera icon () next to the image to take a picture.</p> <p>▶ The picture taken is displayed on the Registered Image frame on the right side of the window.</p> <p>If the picture is not proper, tap the Retry button to take the picture again.</p>  <p>Notes:</p> <ul style="list-style-type: none"> • When the camera icon is grayed out, it is unavailable. Tap the icon when it becomes active (white background). • When the picture is improper, the “Low Score” message is displayed at the bottom of the Image Registration Setup window. Stand at the proper position where the message on the window disappears. 

ACCOUNT OPERATION BY GENERAL USER

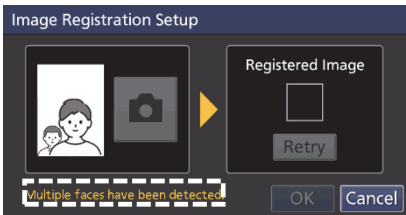
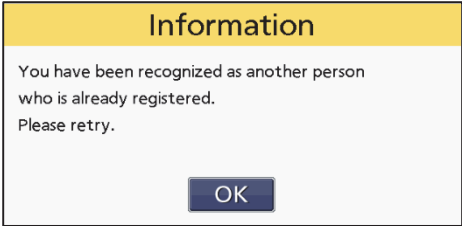
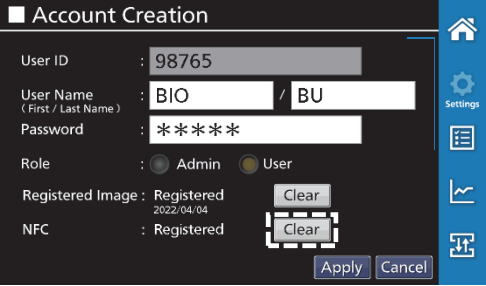
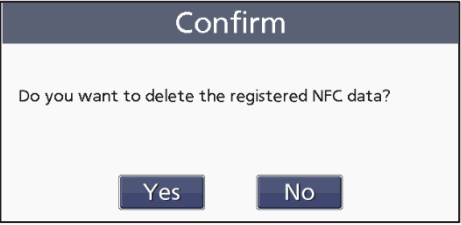
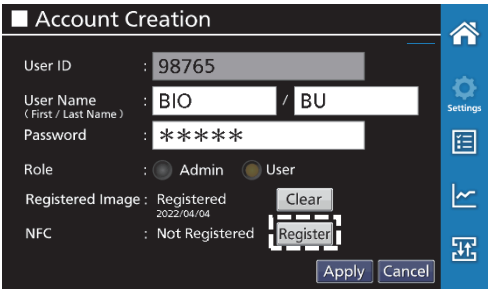
Item	Details
Registered Image	<p> <ul style="list-style-type: none"> When multiple people are recognized in the frame, the “Multiple faces have been detected.” message is displayed at the bottom of the Image Registration Setup window. Take the picture alone. </p>  <p>5. Tap the OK button.</p> <p>▶ The indication at the Registered Image item changes from “Not Registered” to “Registered” and the registration date is displayed. Also, the Register button changes to the Clear button.</p> <p>Note: If the person in the picture is recognized as the same person who has been already registered, the following Information message is displayed. Tap the OK button and retake a picture.</p> 
NFC	<p>1. Tap the Clear button at the NFC item on the Account Creation screen.</p> <p>▶ The Confirm message is displayed to ask you if you really want to delete the NFC device registration.</p>  <p>2. Tap the Yes button.</p> <p>▶ The registered NFC device is deleted and the indication at the NFC item changes from “Registered” to “Not Registered.” Also, the Clear button changes to the Register button.</p> <p>Note: If you tap the No button, the screen returns to the Account Creation screen.</p>  <p>3. Tap the Register button at the NFC item on the Account Creation screen.</p> <p>▶ The NFC Registration message prompts you to hold an IC card or NFC device over the NFC reader.</p> 

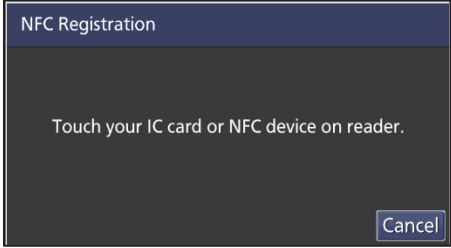
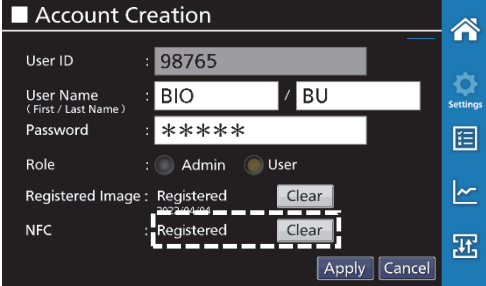
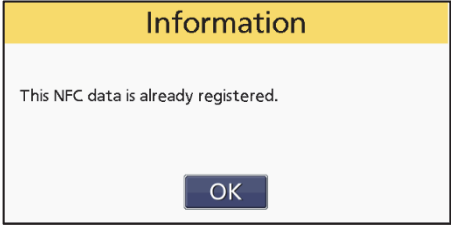
Item	Details
NFC	<p>4. Hold an IC card or NFC device over the NFC reader. ▶ Once the registration is completed, the screen returns to the Account Creation screen. The indication at the NFC item changes from “Not Registered” to “Registered.” Also, the Register button changes to the Clear button.</p> <p>Notes:</p> <ul style="list-style-type: none"> • If you tap the Cancel button without holding an IC card or NFC device over the reader, the screen returns to the Account Creation screen. • If the card or NFC device has been already registered, the following Information message is displayed. Tap the OK button and register another IC card or NFC device.   

4. Tap the Apply button.

▶ The values are saved and the screen returns to the Settings screen.

5. Tap the Home button in the sidebar menu.

▶ The screen returns to the Home screen.

ELECTRIC LOCK AND LOGIN/LOGOUT

About electric lock

Electric lock is a function that automatically locks the outer door after the door is closed (the outer door needs to be firmly closed by pushing the outer door handle towards the cabinet side to engage its latch). This function becomes active when the security mode is set to ON (refer to pages 27 and 28), making the stored samples safer.

* Locking and unlocking the outer door occur at the same timing as logging out and logging in to user accounts respectively.

The outer door gets electrically locked (logout) when:

- a specified amount of time (page 52) has elapsed without no user intervention after the outer door was closed,
- the outer door is closed (while the Auto Logout (Door) setting is turned ON (page 52)), or
- the Logout button on the Home screen is tapped with the outer door closed.

The outer door gets electrically unlocked (login) when:

- a user is authenticated by tapping the Login button and choosing the login method,
- a user is authenticated by the auto face recognition function, or
- a user is authenticated by holding a registered card or NFC device over the NFC reader (option).

Lock (Logout)

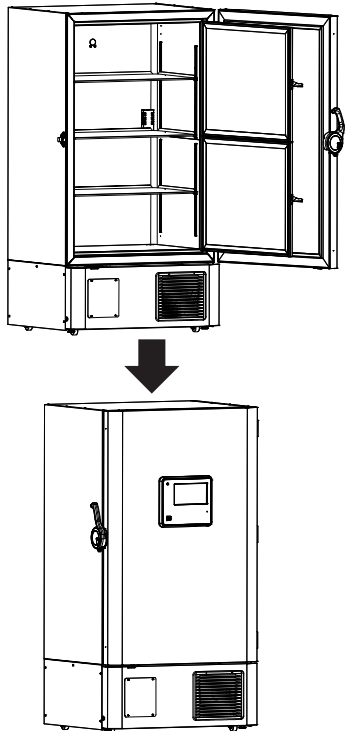

- A specified amount of time has elapsed.
→ See page 52.
- The outer door is closed (Auto Logout Door: ON).
→ See page 52.
- The Logout button is tapped.
→ See page 22.

Unlock (Login)

- Tap the Login button and choose the login method.
→ See pages 53-56.

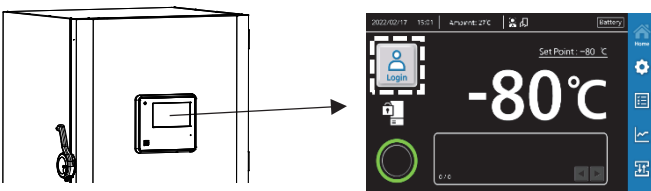

- Auto face recognition. → See page 56.

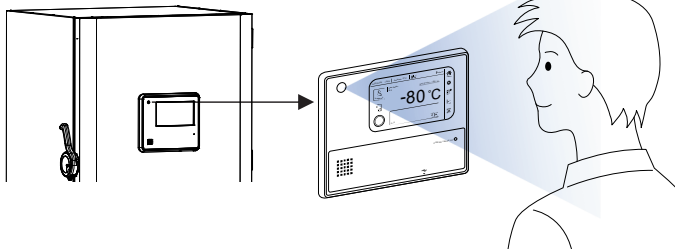

- NFC authentication (when the optional NFC reader is installed).

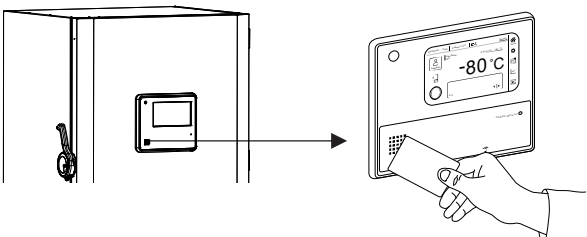

Setting electric lock (log in/log out method)

To configure the electric lock settings (login/logout method), a user must log in to the freezer as an administrator. Follow the steps below to configure the settings.

1. Tap the Settings button  in the sidebar menu.

► The Settings screen is displayed.

Notes:

- When the screen lock is set to ON, you are prompted to enter the password for the screen lock. Enter the password and turn off the screen lock.
- If you are not logged in, the Information message to indicate that you need to log in is displayed. Tap the OK button and log in to the freezer as an administrator.

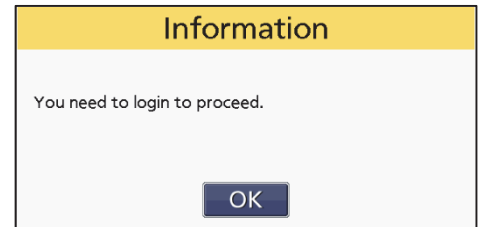

2. Tap the Security Settings button on the Settings screen.

► The Security Settings screen is displayed.

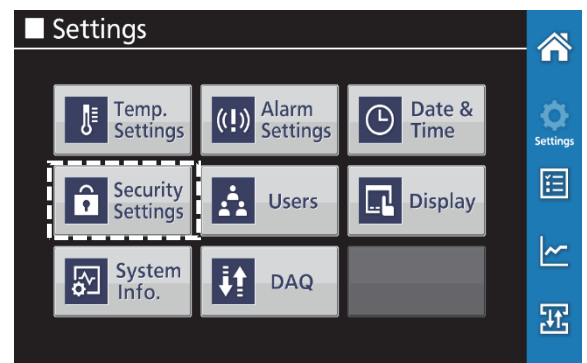

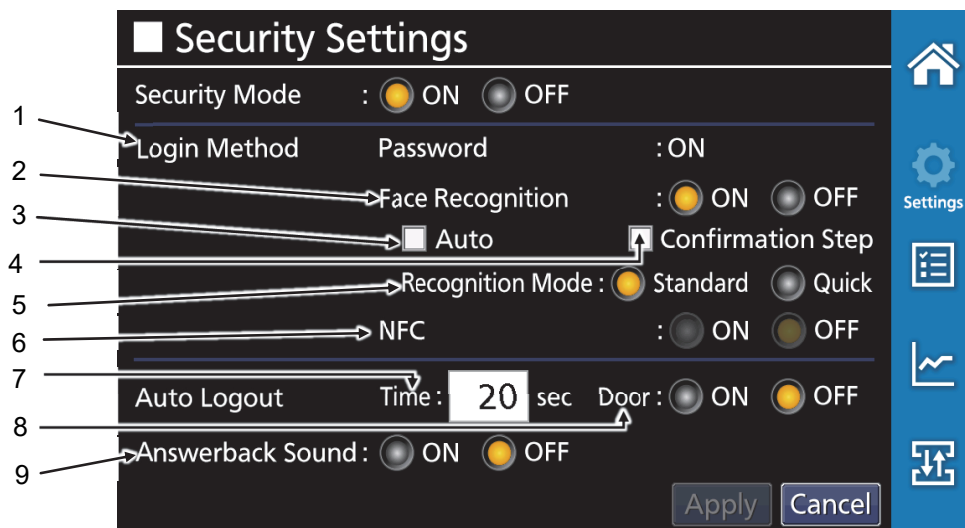

3. Configure each item on the Security Settings screen.



ELECTRIC LOCK AND LOGIN/LOGOUT

Details of entry

No.	Item	Details	Settable range	Default value*
Login Method (Unlock)				
1	Password	A user is authenticated by entering a user ID and a password registered for their account. This setting is automatically turned ON when the security mode is set to ON.	—	ON
2	Face Recognition	A user is authenticated by matching the face image registered in advance to the image currently being caught by the camera mounted on the freezer. When set to ON, the face recognition function is turned on and  icon is displayed on the upper part of the Home screen. Tap the ON or OFF radio button to select the setting.	ON/OFF	ON
3	Auto	While the Auto is selected and the Home screen is displayed, the face recognition function automatically activates and performs authentication when you face the camera on the freezer without selecting the login method. When selected,  icon is displayed on the upper part of the Home screen. Tap the checkbox to enable the automatic face recognition. Note: For preventing malfunction, the automatic face recognition function does not work for about 20 seconds right after logging out.	<input checked="" type="checkbox"/> /□	<input type="checkbox"/>
4	Confirmation Step	If this checkbox is selected, user ID and user name are displayed in the Login User window after the authentication using the face recognition function through the Login button. You can confirm that the displayed user name and ID are correct before logging in.	<input checked="" type="checkbox"/> /□	<input type="checkbox"/>
5	Recognition Mode	The face recognition function has two modes: Standard and Quick. In the Quick mode, authentication speed is faster than in the Standard mode for users' convenience but the recognition may become less accurate. Tap the Standard or Quick radio button to select the mode.	Standard/ Quick	Standard
6	NFC	A user is authenticated by using the optional NFC reader. When set to ON, the NFC authentication is turned ON and the  icon is displayed on the upper part of the Home screen. Tap the ON or OFF radio button to select the setting.	ON/OFF	OFF
Logout method (Lock)				
7	Auto Logout: Time	When a user is in a logged-in state and there is no touch panel operation for the time period specified in this field, the screen returns to the Home screen and the user is automatically logged out after 5 seconds (door lock). Tap the input field to enter the time. The time can be set in increments of 10 seconds.	10 sec to 600 sec	20 sec
8	Auto Logout: Door	When set to ON, the outer door gets locked right after the door is closed regardless of the time set to the above Auto Logout: Time item. Tap the ON or OFF radio button to select the setting.	ON/OFF	OFF
Beep sound when the outer door is locked/unlocked				
9	Answerback Sound	When set to ON, you can hear the beep sound to confirm that the outer door is locked (one short beep) or unlocked (two short beeps). Tap the ON or OFF radio button to select the setting.	ON/OFF	OFF

*The default value is the value when the security mode is set to ON for the first time.

4. Tap the Apply button.

▶ The values are saved and the screen returns to the Settings screen.

5. Tap the Home button in the sidebar menu.

▶ The screen returns to the Home screen.

Unlocking (logging in) by the Login button

You can unlock (log in to) the freezer by tapping the Login button on the Home screen and selecting the login method.

1. Tap the Login button on the Home screen.
 - ▶ The Login window for selecting the login method is displayed.

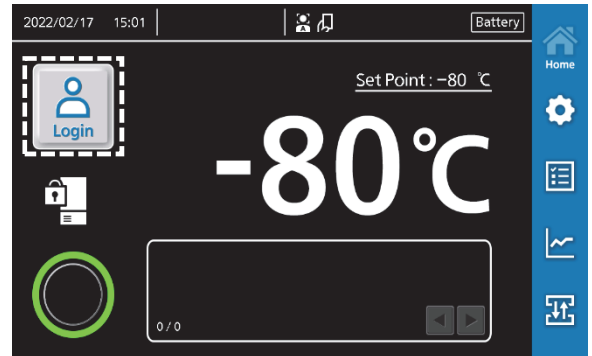

2. Tap the Face Recog. or Password or NFC radio button to select the login method.
 - ▶ The content of the window switches to show respective instruction.

Note:

You can select the login method that is set to "ON" on the security Settings screen.

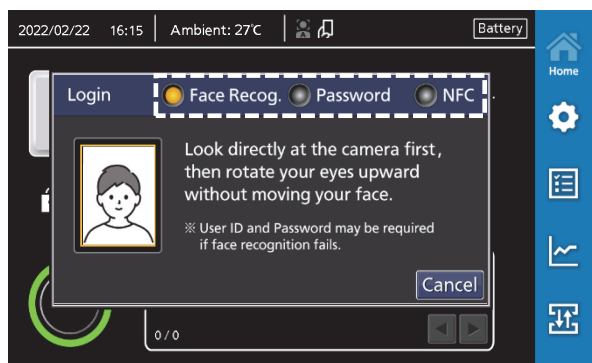

3. Log in to your account using the selected method.

Face recognition

1) Face the camera at the upper left corner of the control panel and check that you are in the middle of the frame by looking at the image on the left side of the window.

Notes when using face recognition

- Perform the face recognition procedure alone. If multiple people are in the frame, you cannot be authenticated.
- If the appearance of the user is significantly different from the face recognition image taken when it was registered such as wearing glasses, hats, or facial hair, the face recognition function may not work.
- For proper authentication, shift your eyes upward with keeping your head still once the authentication process has started.

Shift your eyes upward.

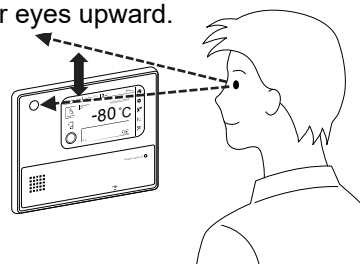

- If the face recognition does not work and the password input screen is displayed every time, clear the currently registered face image and register it again.

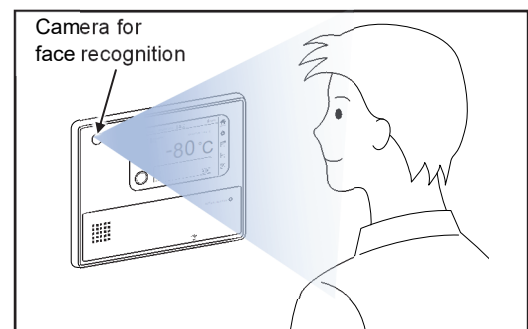

[Face recognition mode: Standard]

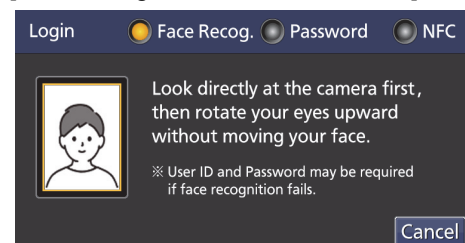

[Face recognition mode: Quick]



ELECTRIC LOCK AND LOGIN/LOGOUT

Note:

If you are not authenticated for about 20 seconds in the Standard mode or about 10 seconds in the Quick mode, the Login window with the Password radio button turned on is displayed. Log in to your account using password authentication or NFC authentication (when the optional NFC reader is installed).

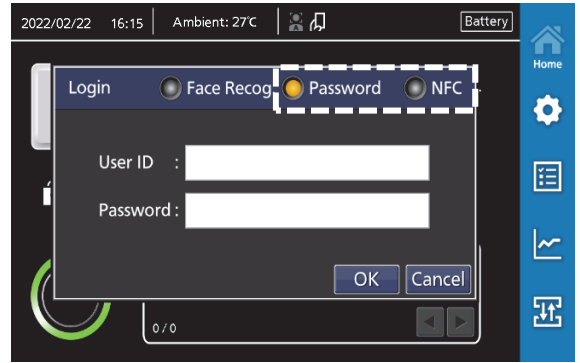

- ▶ After successful authentication, the outer door is unlocked and the screen returns to the Home screen. The login button on the Home screen changes to the Logout button and your user name is displayed on the right side of the button.

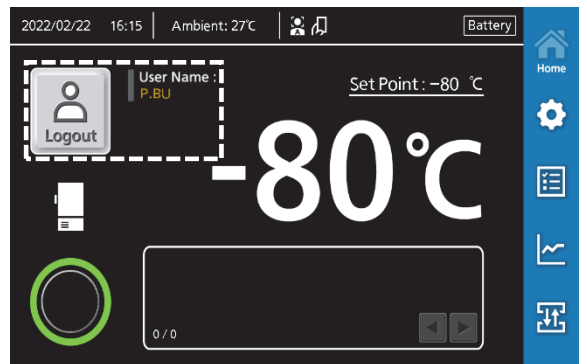

Notes:

- If the Confirmation Step checkbox has been selected on the Security Settings screen, the registered user ID and user name are displayed before logging into the account for confirming that you are the right user. If the user account is correct, tap the Login button to log in to the account (unlock).
- The first name of user that has been entered on the Account Creation screen is indicated by initial on the Login User window and the Home screen.

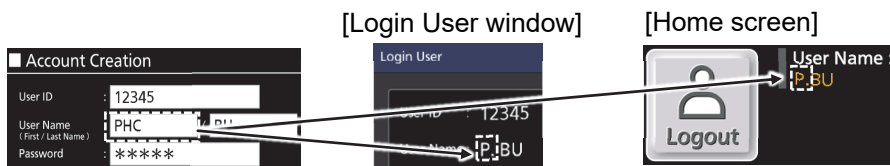
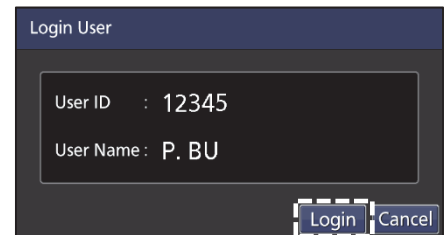

- When the position is improper, the “Low Score” message is displayed. Stand at the proper position where the message on the window disappears.



- When multiple people are recognized in the frame, the “Multiple faces have been detected.” message is displayed. Take the picture alone.
- * Although the screens show the examples when the face recognition mode is set to the Standard mode, the same messages appear in the Quick mode.



Password authentication

- 1) Tap the Password radio button.
 - ▶ User ID and Password input fields are displayed.

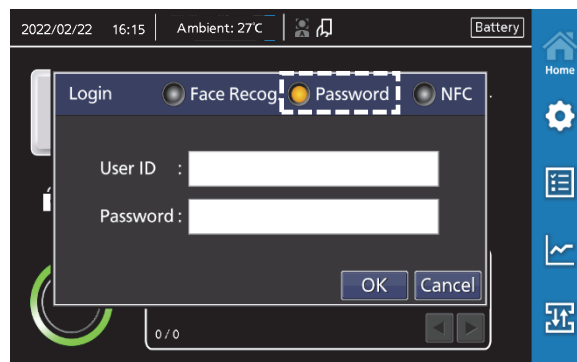

- 2) Tap the input fields to enter your user ID and password.

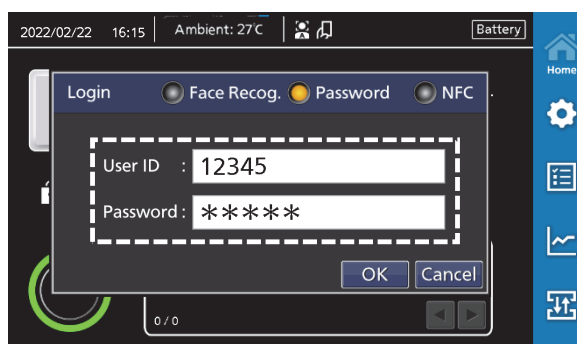

- 3) Tap the OK button.

▶ If you are successfully authenticated, the outer door is unlocked and the screen returns to the Home screen. The Login button on the Home screen changes to the Logout button and your user name is displayed on the right side of the button.

If you are not authenticated, the following Information message is displayed. Tap the OK button and reenter the user ID and password or try a different login method.

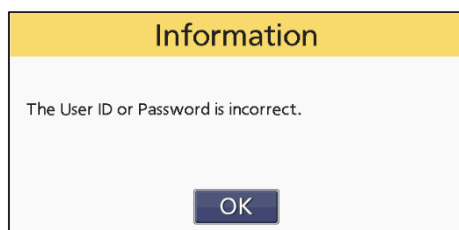
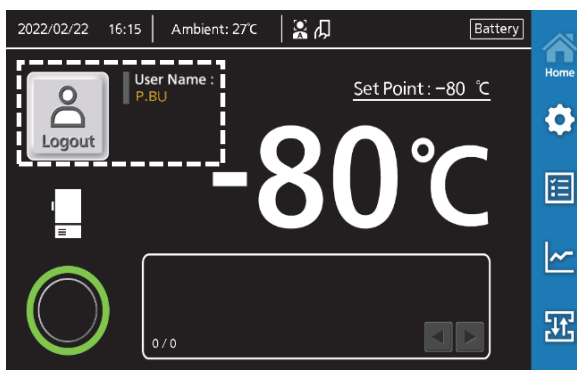

ELECTRIC LOCK AND LOGIN/LOGOUT

NFC authentication (when the optional NFC reader is installed)

1) Tap the NFC radio button.

▶ A message prompts you to hold your IC card or NFC device over the NFC reader.

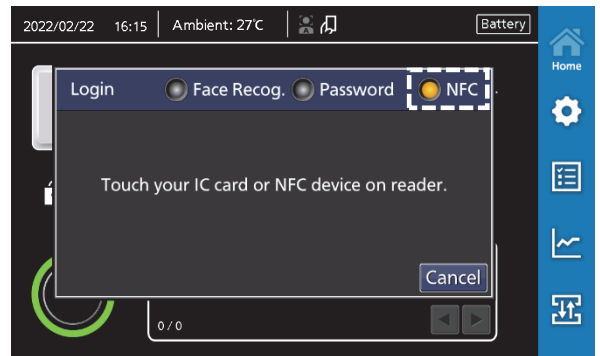

2) Hold your IC card or NFC device registered to your account over the NFC reader.

▶ If you are successfully authenticated, the outer door is unlocked and the screen returns to the Home screen. The Login button on the Home screen changes to the Logout button and your user name is displayed on the right side of the button.

If you are not authenticated, the following Information message is displayed. Tap the OK button and hold a different IC card or NFC device or try a different login method.

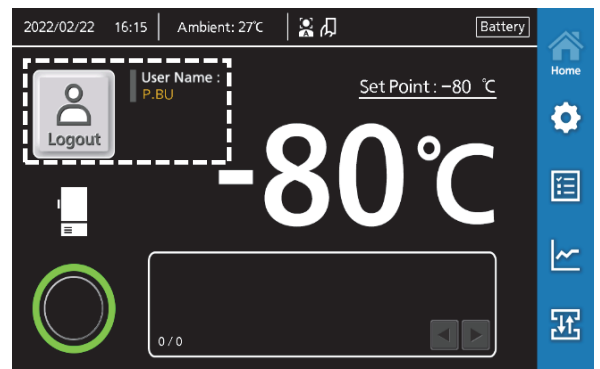
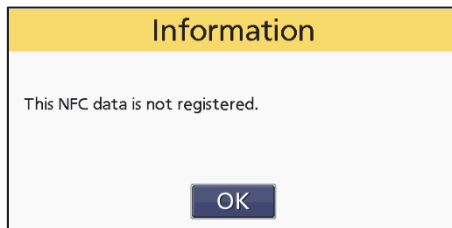
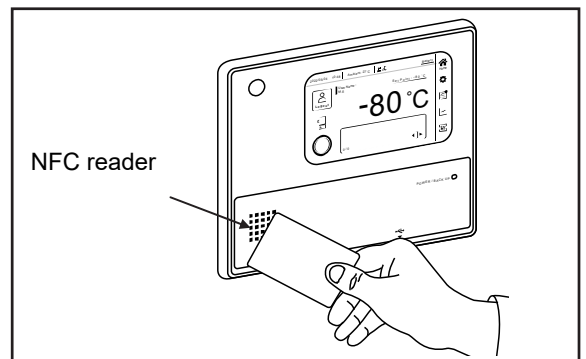

Unlocking (logging in) by auto face recognition

If the Face Recognition is set to ON and Auto is selected on the Security Settings screen, the face recognition function automatically activates when the Home screen is displayed. Therefore, you are authenticated automatically and can unlock (log in to) the freezer when you stand in front of the camera equipped with the freezer without selecting the login method.

Note:

If Auto is selected on the Security Settings screen, the auto face recognition icon  is displayed on the upper part of the Home screen.

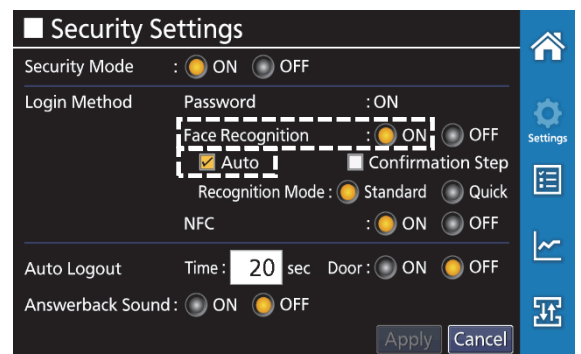

To perform auto face recognition to unlock the outer door (log in), face the camera at the upper left corner of the control panel when the Home screen is displayed.

► If you are successfully authenticated, the outer door is unlocked.

The Login button on the Home screen changes to the Logout button and your user name is displayed on the right side of the button.

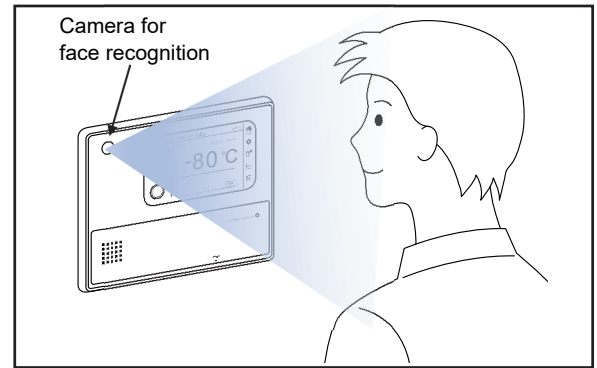

Notes when using face recognition

- Perform the face recognition procedure alone. If multiple people are in the frame, you cannot be authenticated.
- If the appearance of the user is significantly different from the face recognition image taken when it was registered such as wearing glasses, hats, or facial hair, the face recognition function may not work.
- For proper authentication, shift your eyes upward with keeping your head still once the authentication process has started.

Shift your eyes upward.

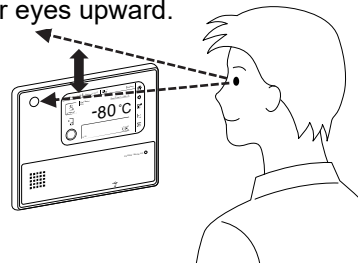

- When the face recognition takes too much time or the recognition does not work properly, clear the currently registered face image and register it again.
- If the recognition still does not work, try a different login method (password or NFC (if the optional NFC reader is installed)).

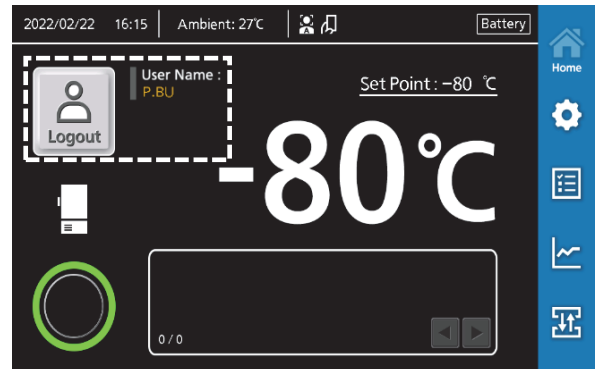

Notes:

- During face recognition process, the auto face recognition icon  blinks.
- The automatic face recognition function does not work for about 20 seconds right after logging out to prevent malfunction. The icon turns gray during this period.

Unlocking (logging in) by NFC authentication

If the optional NFC reader is installed on this freezer and NFC is set to ON in the Security Settings screen, you can unlock (log in to) the freezer by holding your IC card or NFC device over the NFC reader.

Note:

If NFC is selected on the Security Settings screen, the NFC icon  is displayed on the upper part of the Home screen.

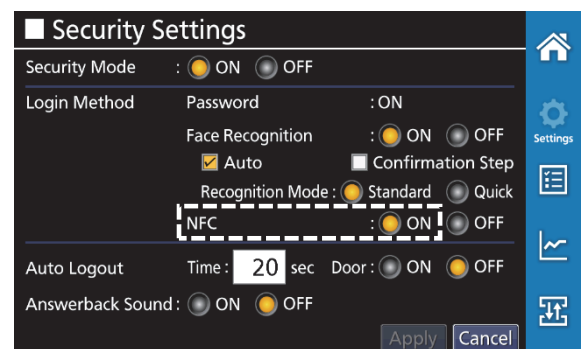

ELECTRIC LOCK AND LOGIN/LOGOUT

To log in, hold your IC card or NFC device registered to your account over the NFC reader when the Home screen is displayed.

► If you are successfully authenticated, the outer door is unlocked and the screen returns to the Home screen. The Login button on the Home screen changes to the Logout button and your user name is displayed on the right side of the button.

If you are not authenticated, the following Information message is displayed. Tap the OK button and hold a different IC card or NFC device or try a different login method.

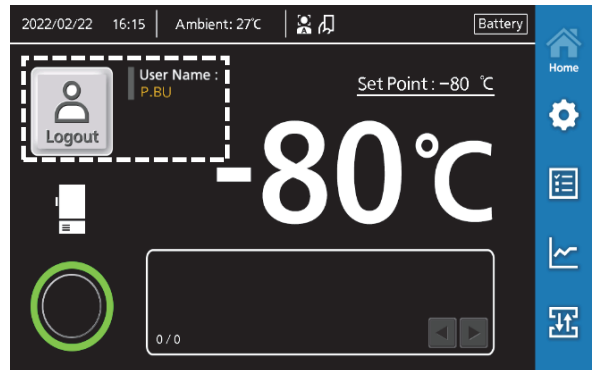
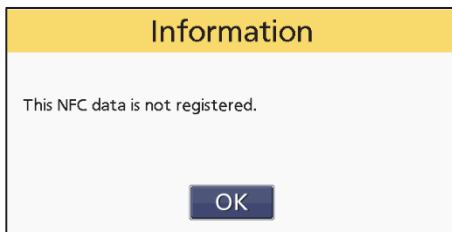
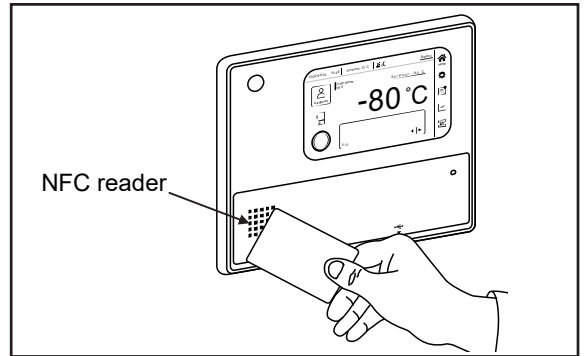



Locking/unlocking the outer door during power failure

In the event of a power failure, you can unlock or lock the outer door by following the steps below.

- When the capacity of the battery for power failure alarm is remaining (LCD touch panel is turned on), you can unlock the outer door by tapping the Login button and selecting the login method (Face Recog./Password/NFC) or holding your IC card or NFC device over the NFC reader, but the auto face recognition function does not work.
- When the capacity of the battery for power failure alarm is not remaining (LCD touch panel is turned off), unlock or lock using the accessory key and the lock system at the lower part of the outer door handle.

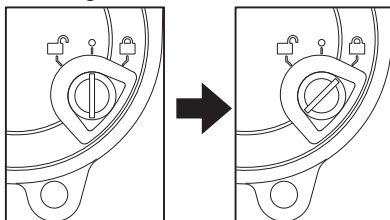
1. Locking the door



Insert the key into the key slot and turn it 45 degrees clockwise (to the position marked with ). After the door is locked, turn the key back to the first position and take it out of the lock system.

2. Unlocking the door

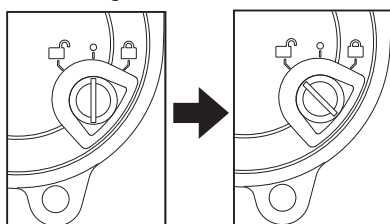

Insert the key into the key slot and turn it 45 degrees counterclockwise (to the position marked with ). After the door is unlocked, turn the key back to the first position and take it out of the lock system.

Notes:

- After locking/unlocking the door, be sure to take the key out of the key hole and store and manage it in a safe place.
- If the key is lost, contact our sales representative or agent and provide the number stamped in the metal near the key slot.

4. SETTINGS AND OPERATION

SETTING FOR BASIC OPERATION

Setting temperature and high/low alarms

The chamber temperature, high temperature alarm, and low temperature alarm can be set by following the steps below.

When the security mode is set to ON and a user is logged in as a user role, the user can see the setting values but cannot configure or change the setting (refer to page 26).

1. Tap the Settings button  in the sidebar menu.
 - ▶ The Settings screen is displayed.
2. Tap the Temp. Settings button on the Settings screen.
 - ▶ The Temp. Settings screen for setting temperature is displayed.

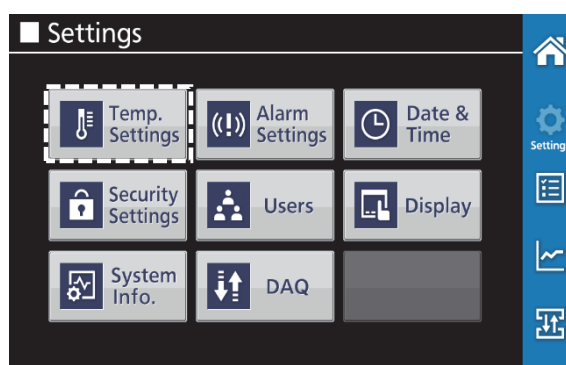

3. Tap the numeric input field to enter each value.

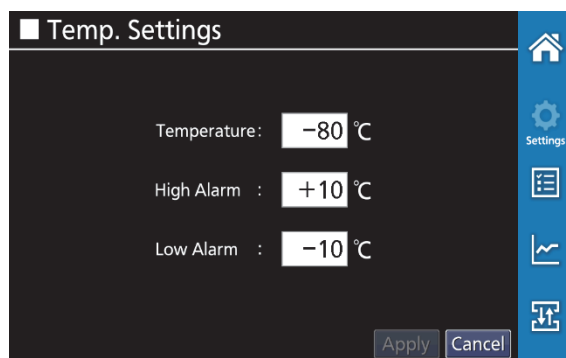

Details of entry

Item	Details	Settable range	Default value
Temperature	Temperature set point of the freezer.	-90 °C to -40 °C	-80 °C
High Alarm	When the chamber temperature exceeds the temperature (value set to "Temperature" + value set to "High Alarm"), the high alarm activates.	+5 °C to +40 °C	+10 °C
Low Alarm	When the chamber temperature falls below the temperature (value set to "Temperature" - value set to "Low Alarm")*, the low alarm activates.	-40 °C to -5 °C	-10 °C

* Since the chamber temperature displayed on the Home screen is the value rounded to the nearest integer, the high/low alarm may activate when the value of the displayed chamber temperature is equal to the set alarm temperature.

4. Tap the Apply button.
 - ▶ The values are saved and the screen returns to the Settings screen.
5. Tap the Home button in the sidebar menu.
 - ▶ The screen returns to the Home screen.

SETTING FOR BASIC OPERATION

Configuring other alarm settings and compressor delay time

On the Alarm Settings window, the alarm delay time, door delay time, ring back function, remote alarm, and compressor delay time can be configured.

When the security mode is set to ON and a user is logged in as a user role, the user can see the setting values but cannot configure, change the setting, or perform alarm test (refer to page 61).

1. Tap the Settings button  in the sidebar menu.
▶ The Settings screen is displayed.
2. Tap the Alarm Settings button on the Settings screen.
▶ The Alarm Settings screen for configuring alarm related settings and compressor delay time is displayed.

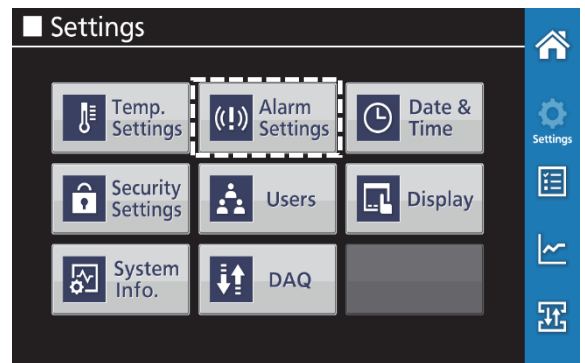

3. Tap the numeric input field to enter each value or slide the ON/OFF buttons to configure the settings.

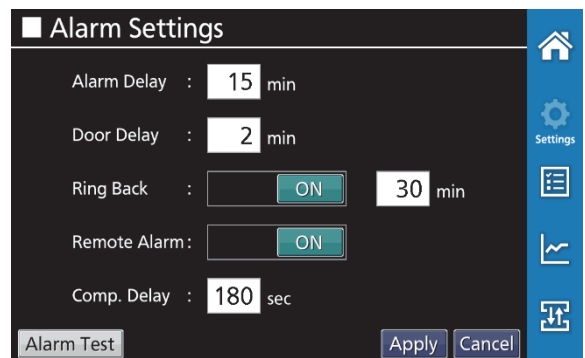

Details of entry

Item	Details	Settable range	Default value
Alarm Delay	Alarm delay is a function that when the High Alarm or Low Alarm status occurs, instead of activating audible alarm or remote alarm immediately, activates the alarm after elapse of the set alarm delay time. Note: When the freezer recovers from the alarm status within the set alarm delay time, audible alarm or remote alarm does not activate after the elapse of the alarm delay time.	0 to 15 min	15 min
Door Delay	Door delay is a function that when the unit is in the door alarm (the outer door is open) state, instead of sounding immediately, the alarm will sound after the elapse of the set door delay time. Note: When the unit recovers from the alarm status within the set door alarm delay time, the door alarm does not activate after the elapse of the door alarm delay time.	0 to 15 min	2 min
Ring Back	Ring back is a function that the audible alarm sounds again when an alarm status still continues after the ring back set time elapsed even though the alarm sound was stopped by tapping the Buzzer Stop button. The Ring Back can be turned ON/OFF by sliding the ON/OFF button. When turning it on, enter the ring back time in the right numeric input field. Note: For the door alarm, the alarm does not activate again since the alarm itself is deactivated by tapping the Buzzer Stop button (page 88).	ON/OFF 1 to 99 min	ON 30 min

Item	Details	Settable range	Default value
Remote Alarm	Selects behavior of the remote alarm when the Buzzer Stop button is tapped to stop the audible alarm sound of the freezer unit. When "ON" (not linked with the Buzzer Stop button) is selected by sliding the button to the right, the alarm indication by the remote alarm device does not stop even if the Buzzer Stop button is tapped. ON: Not linked with the Buzzer Stop button (remote alarm continues) OFF: Linked with the Buzzer Stop button (remote alarm stops)	ON/OFF	ON
Comp Delay	Compressor delay time is the time from when the freezer is turned ON until when the compressor starts up. This unit requires a large amount of electric power at the instant of compressor start-up. If multiple freezer units are installed in a same room, shift the start-up time of each compressor so that the compressors do not start up at the same time after a power failure.	180 sec to 600 sec	180 sec

4. Tap the Apply button.

▶ The values are saved and the screen returns to the Settings screen.

5. Tap the Home button in the sidebar menu.

▶ The screen returns to the Home screen.

About alarm test

You can check if the alarm activates properly by long tapping the Alarm Test button at the lower-left corner of the Alarm Settings screen for about 3 seconds. When the alarm activates, the following alarm status can be observed.

- Audible alarm beeps.
- Returns to the Home screen to show the red status indicator and the Buzzer Stop indication.
- Power/Alarm lamp (LED) blinks in red.
- "Alarm Test" is displayed in the message display area.
- Remote alarm activates (if installed).

The test alarm status is canceled by tapping the Buzzer Stop button.

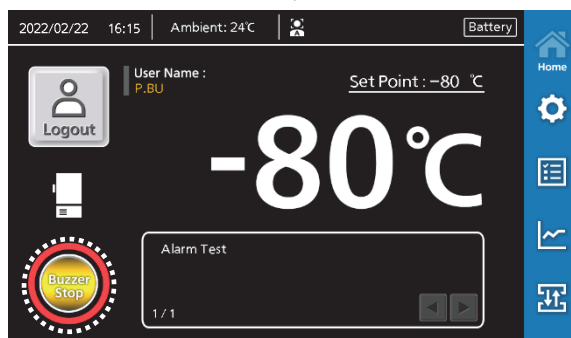
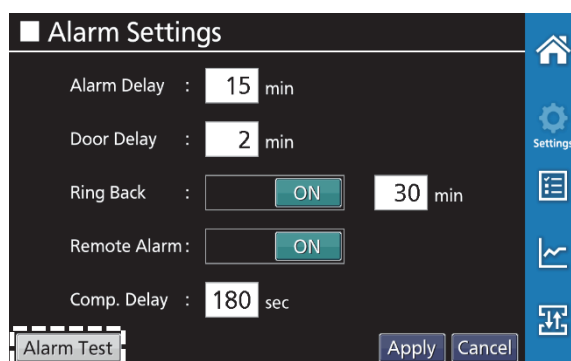

SCREEN LOCK

Screen lock is a function to avoid unauthorized changes to the settings of the freezer when the access to the freezer is not restricted by the security mode (page 26). When the screen lock is set to ON, if you try to tap the Settings button or the Import/Export button, you are asked to enter a password. This function is available while the security mode is set to “OFF.”

To turn off the security mode, tap the Settings button in the sidebar menu, select Security Settings button, and then set the Security Mode to “OFF.”

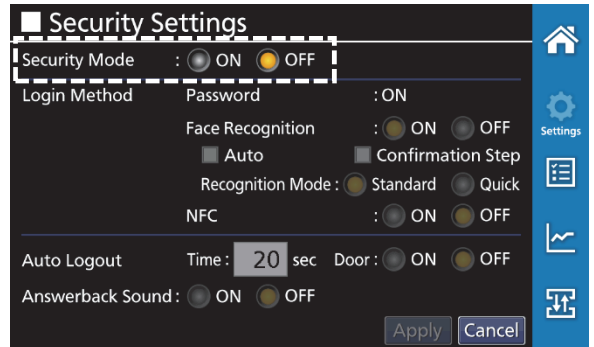

Setting screen lock

To set the screen lock, follow the steps below.

1. Tap the Settings button  in the sidebar menu.
▶ The Settings screen is displayed.
2. Tap the Display button on the Settings screen.
▶ The Display screen for configuring the screen related setting is displayed.

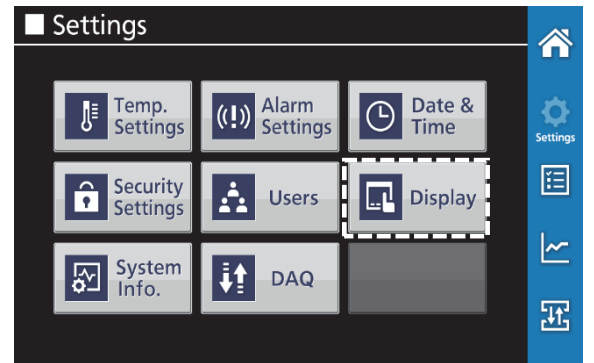

3. Configure the settings in the dotted square shown in the right figure.

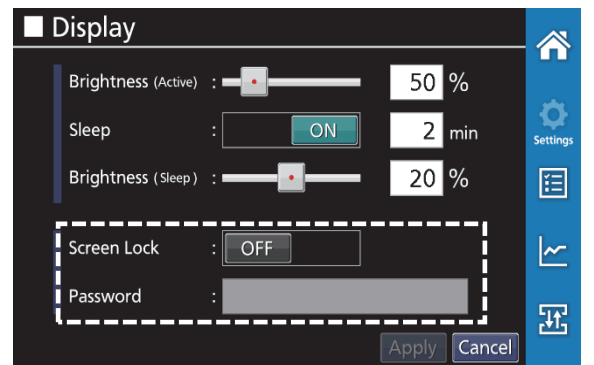

Item	Details	Settable range	Default value
Screen Lock	Slide the slide button to turn ON or OFF the screen lock function. To turn ON, slide the button to the right.	ON/OFF	OFF
Password	<p>Enter a password to be used for unlocking the screen. You can use 4 to 8 alphanumeric characters and symbols for the password. You need to enter it twice for confirmation</p> <ol style="list-style-type: none"> Tap the password input field. ▶ The alphanumeric input window is displayed. Enter a 4-8 character password and tap the OK button. ▶ The Information message prompting you to enter the same password again is displayed. <p>Note: If the password you entered is less than 4 characters, the following message is displayed. Tap the OK button and enter another password to satisfy the character length.</p> <ol style="list-style-type: none"> Tap the OK button. ▶ The alphanumeric input window is displayed again. Enter the same password as step 2 and tap the OK button. ▶ The Display screen appears. <p>Note: If the password is not the same one as entered in step 2, the following message is displayed. Tap the OK button and follow the steps again from step 1.</p>	4 to 8 alphanumeric characters and symbols	-

4. Tap the Apply button.

- ▶ The values are saved and the screen returns to the Settings screen.

5. Tap the Home button in the sidebar menu.

- ▶ The screen returns to the Home screen.

Note:

Be sure to manage the screen unlock password properly.

SCREEN LOCK

Operation when screen lock is ON

When the screen lock is set to ON, if you try to tap the Settings button or the Import/Export button, you are asked to enter a password.

1. Tap the Settings button  or the Import/Export  button in the sidebar menu.

▶ The Password input window is displayed.

2. Enter the screen unlock password and tap the OK button.

▶ The Settings or Import/Export screen is displayed.

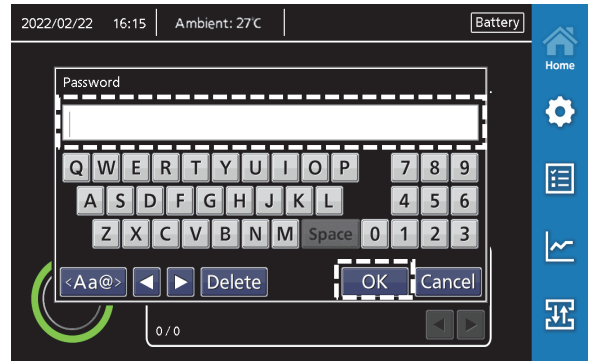

Notes:

- If an incorrect password is entered, the following Information message is displayed. Tap the OK button and enter the correct password.

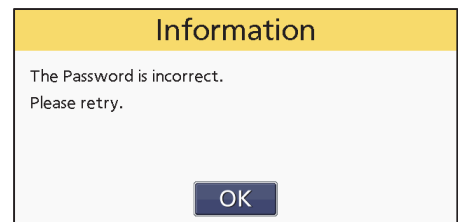

- When the screen lock function is set to ON, you cannot select the Security Settings button on the Settings screen. Therefore, the following message is displayed when you try to tap the Security Settings button. If you need to configure the Security Settings, you need to set the screen lock function to OFF.

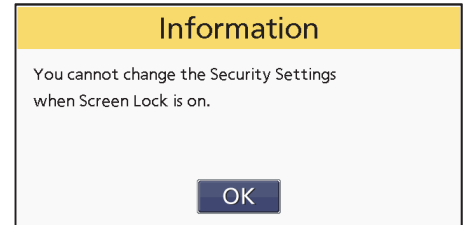

Turning OFF the screen lock setting

To turn off the screen lock setting, follow the steps below.

1. Tap the Settings button  in the sidebar menu.

▶ The Password input window is displayed.

2. Enter the screen unlock password and tap the OK button.

▶ The Settings screen is displayed.

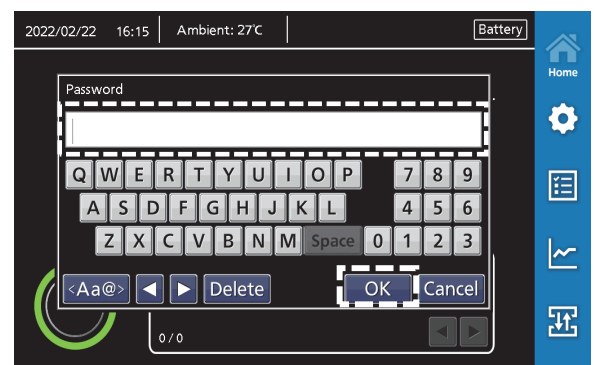

3. Tap the Display button.

▶ The Display screen is displayed.

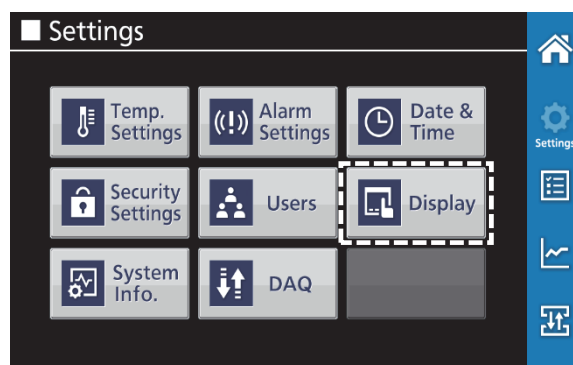

4. Slide the Screen Lock slide button to the left.

▶ The screen lock is set to OFF.

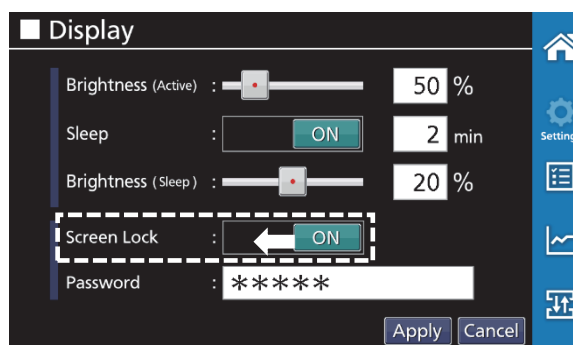

5. Tap the Apply button.

▶ The setting is saved and the screen returns to the Settings screen.

Note:

When the screen lock is set to OFF, the registered password for unlocking the screen lock is deleted.

6. Tap the Home button in the sidebar menu.

▶ The screen returns to the Home screen.

OTHER SETTINGS

Setting date and time

You can set date and time for the freezer.

When the security mode is set to ON and a user is logged in as a user role, the user can see the setting values but cannot configure or change the setting (refer to page 26).

1. Tap the Settings button  in the sidebar menu.
 - ▶ The Settings screen is displayed.
2. Tap the Date & Time button.
 - ▶ The Date & Time screen is displayed.

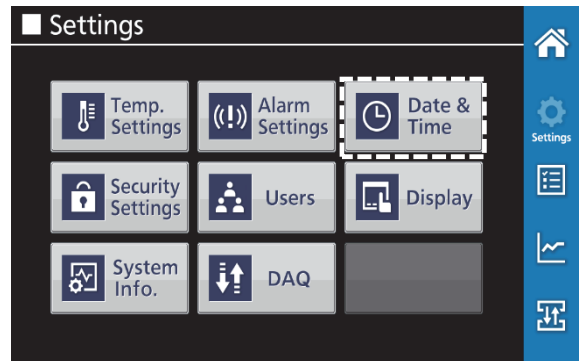

3. Configure the settings in the dotted square shown in the right figure.

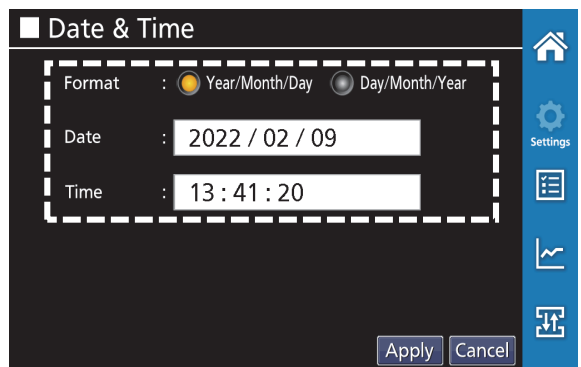

Details of entry

Item	Details	Settable range	Default value
Format	Select the date format by tapping the radio button.	Year/Month/Day or Day/Month/Year	Year/Month/Day
Date	Enter the current date by tapping the input field and tapping the ▲/▼ buttons on the input window. Then, tap the OK button.	-	The date and time has been temporarily set at the factory. Set the correct date and time.
Time	Enter the current time by tapping the input field and tapping the ▲/▼ buttons on the input window. Then, tap the OK button. The time is expressed using a 24-hour clock. Note: It is advisable to set the right time regularly since the error of about 1 minute may be observed within a month.	-	

4. Tap the Apply button.
 - ▶ The values are saved and the screen returns to the Settings screen.
5. Tap the Home button in the sidebar menu.
 - ▶ The screen returns to the Home screen.

Setting brightness and sleep

On the Display screen, you can configure the brightness of the LCD touch panel and the sleep function. When the security mode is set to ON and a user is logged in as a user role, the user can see the setting values but cannot configure or change the setting (refer to page 26).

1. Tap the Settings button  in the sidebar menu.

▶ The Settings screen is displayed.

2. Tap the Display button.

▶ The Display screen is displayed.

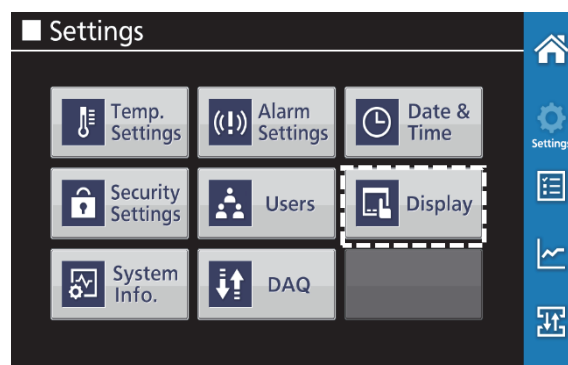

3. Configure the settings in the dotted square shown in the right figure.

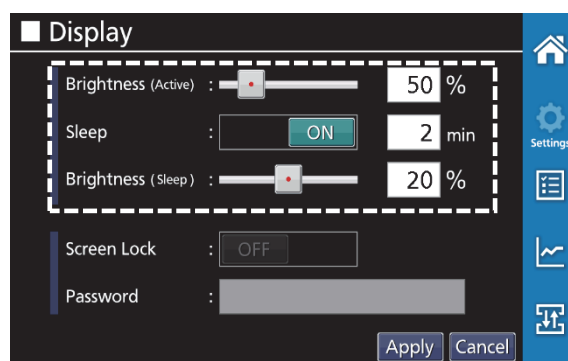

Details of entry

Item	Details	Settable range	Default value
Brightness (Active)	Brightness of the LCD touch panel in normal state. You can set the value using the slider bar or tapping the input field to enter the value.	40 to 100 %	50 %
Sleep	Sleep is a function that decreases the brightness of LCD touch panel to save electricity when there is no touch panel operation. Slide the Sleep slide button to the right to turn ON the Sleep function. Then, enter the time period from the last touch panel operation to the time the Sleep state starts.	ON/OFF 1 to 5 min	ON 2 min
Brightness (Sleep)	Brightness of the LCD touch panel in the Sleep state. You can set the value using the slider bar or tapping the input field to enter the value.	0 to 40 %	20 %

4. Tap the Apply button.

▶ The values are saved and the screen returns to the Settings screen.

5. Tap the Home button in the sidebar menu.

▶ The screen returns to the Home screen.

OTHER SETTINGS

Setting unit name

You can set a unit name that is used at the beginning of a file name when exporting the freezer data in a CSV file.

When the security mode is set to ON and a user is logged in as a user role, the user can see the setting values but cannot configure or change the setting (refer to page 26).

Note: By default, the serial number of the unit is set for the unit name.

1. Tap the Settings button  in the sidebar menu.

▶ The Settings screen is displayed.

2. Tap the System Info. button.

▶ The System Info. screen is displayed.

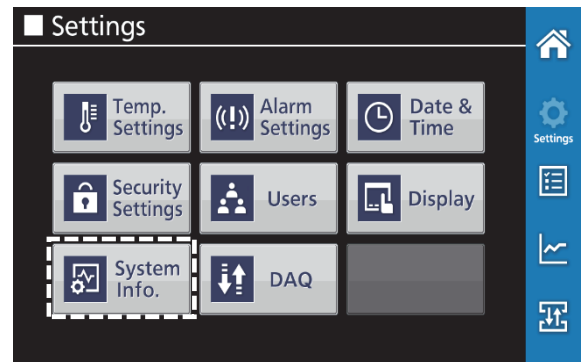

3. Tap the input field for Unit Name.

▶ The alphanumeric input window is displayed.

4. Enter a unit name in alphanumeric characters or symbols (1 to 10 characters) and tap the OK button.

▶ The System Info. screen is displayed.

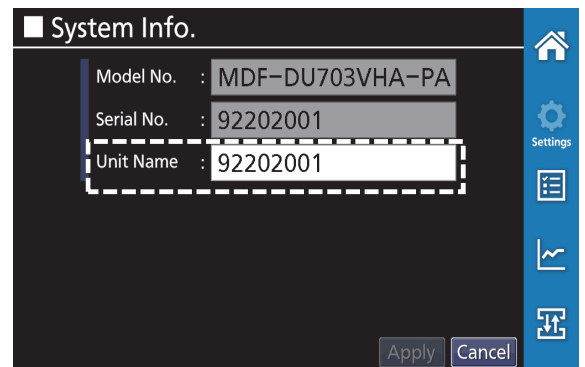

5. Tap the Apply button.

▶ The values are saved and the screen returns to the Settings screen.

6. Tap the Home button in the sidebar menu.

▶ The screen returns to the Home screen.

Setting DAQ

The DAQ setting is required when the optional interface board is installed.

When the security mode is set to ON and a user is logged in as a user role, the user can see the setting values but cannot configure or change the setting (refer to page 26).

For installing the interface board, contact our sales representative or agent.

1. Tap the Settings button  in the sidebar menu.
 - ▶ The Settings screen is displayed.

2. Tap the DAQ button.
 - ▶ The DAQ screen is displayed.

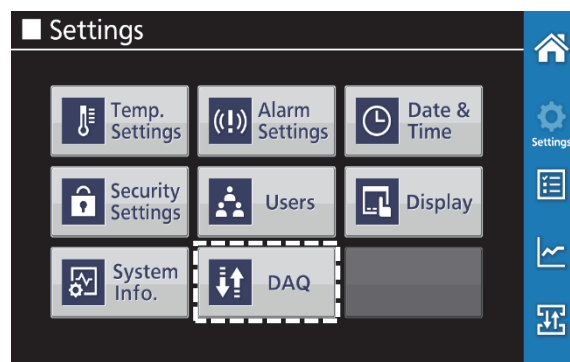

3. Select each value.

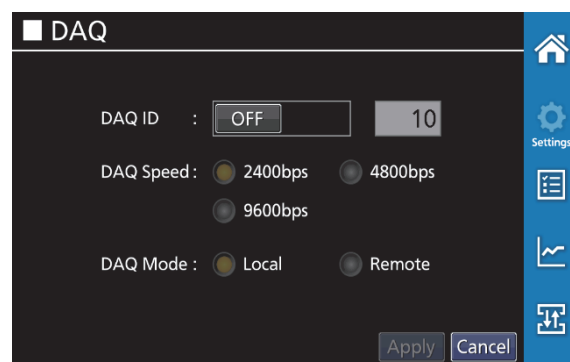

Details of settings:

Item	Details	Settable range	Default value
DAQ ID	Slide the DAQ ID to the right to set it to ON. Then, tap the input field next to the slide button to enter the ID value (1 to 250). Enter the value that is not used for other equipment. Note: Setting for the DAQ Speed and DAQ Mode becomes available when this setting is turned ON.	ON/OFF ID value: 1 to 250	OFF
DAQ Speed	Select the communication speed when the centralized monitoring (DAQ system) is connected by tapping the radio button.	2400 bps, 4800 bps, or 9600 bps	2400* ²
DAQ Mode	Select Local or Remote by tapping the radio button.	Local/Remote* ¹	Local* ²

*1 When "Remote" is selected, you cannot set the chamber temperature set point, high/low alarms, other alarm settings, and compressor delay time from the freezer. The configuration can be set from the remote side.

*2 These are the values when the DAQ ID is turned on for the first time.

4. Tap the Apply button.
 - ▶ The values are saved and the screen returns to the Settings screen.

5. Tap the Home button in the sidebar menu.
 - ▶ The screen returns to the Home screen.

EVENT LOG

This product is provided with a function to store event log data such as alarm messages.

- Log data type: Alarm messages, notice messages, outer door status, login/logout, settings, acknowledge, boot, and alarm test.
- Up to 40,000 logs can be stored. When the number of logs exceeds the maximum number, the oldest log data is overwritten with the new data.
- When the battery switch for power failure alarm is turned on and the battery capacity is remaining, the event log data continues to be recorded even during a power failure.

Event Log screen

The Event Log screen consists of the following items.

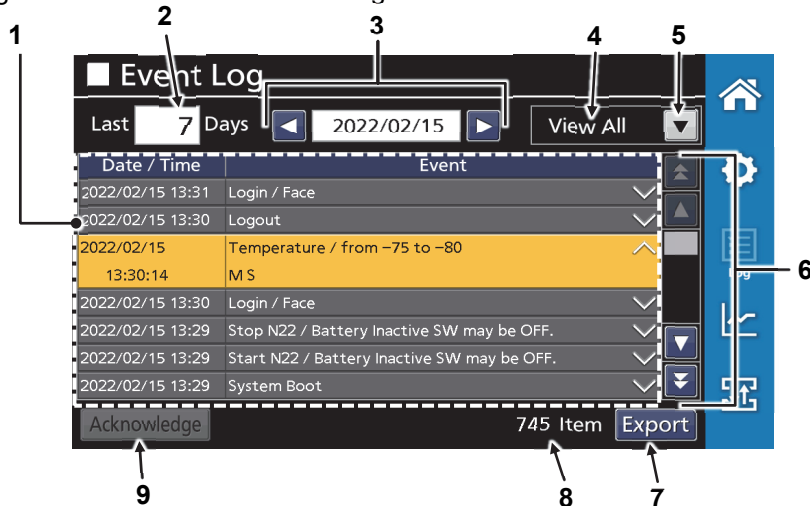

No.	Item	Details
1	Event log indication	<p>Indicates event log information stored in the freezer (date/time, details of an event, user name).</p> <p>Tapping the v mark on the right side of the Event column expands the indication area (2-line indication).</p> <p>Tapping the ^ mark on the right side of the Event column collapses the indication area (1-line indication).</p> <p>The following information is displayed in the second line.</p> <ul style="list-style-type: none"> • In the case of Alarm, Notice, or Pending Items event: <ul style="list-style-type: none"> If the beginning of the first line is "Start," no information is displayed (blank). If the beginning of the first line is "Stop," the time when the event occurred is displayed. • In the case of Door, Login/Logout, Setting, or System event: <ul style="list-style-type: none"> If the user is an administrator, name of the user who was logged in when the event occurred is displayed. If the user is a general user their registration number is displayed (page 36).
2	Period setting	Number of days
3		Base date
4	Filtering status indication	<p>View All: Indicates all event logs are displayed.</p> <p>Filter On: Indicates selected logs are displayed.</p>
5	Filtering item selection pull-down	Tapping ▼ button displays the pull-down lists from where you can select the types of event log you wish to display. Select the types of event log by tapping the checkbox.
6	Scroll buttons	<p>Tapping the button scrolls up one page.</p> <p>Tapping the button scrolls up one line.</p> <p>Tapping the button scrolls down one line.</p> <p>Tapping the button scrolls down one page.</p>

No.	Item	Details
7	Export button*	Tapping this button exports the selected event log data to the USB flash drive inserted into the USB port in CSV format.
8	Number of events	Indicates the total number of events stored in this product.
9	Acknowledge button	Tapping this button acknowledges the selected one event. For details, refer to page 72.

* When the security mode is set to ON, the user logged in as a general user cannot use the Export button.

Viewing the event log data

You can view the event log data by selecting the duration and event types.

1. Tap the event log button  in the sidebar menu.
▶ The Event Log screen is displayed.
 2. Tap the base date input field on the Event Log screen.
▶ The date input window is displayed.
 3. Tap the ▲/▼ buttons to enter the date and tap the OK button.
▶ The Event Log screen is displayed.
- Note:**
Tapping ◀ and ▶ buttons can display the previous date and next date respectively.

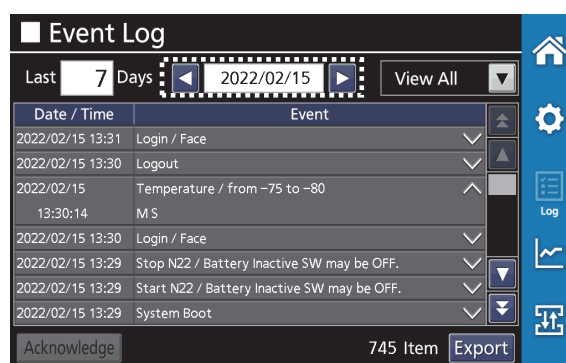

4. Tap the Number of days input field.
▶ The numeric input window is displayed.
5. Enter the number of days you want to display the events that occurred on and before the base date specified in step 3.

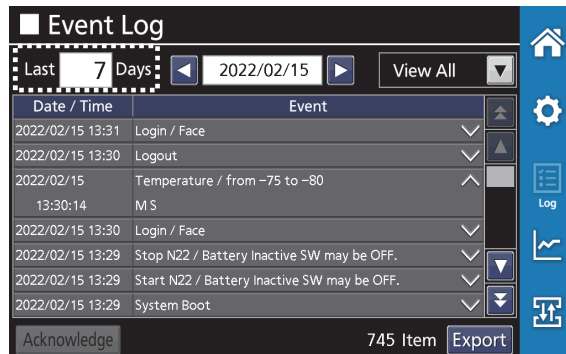

6. Tap the Filtering item selection pull-down and select the event types you want to display.
▶ The selected types of events occurred during the selected period of days are displayed.

Items in the Filtering item selection list

Item	Details
View All	All event logs
Alarm	Alarm message log
Notice	Notice message log
Door	Outer door open/close status log
Login/Logout	Login/logout log
Setting	Setting button access log
System	Log for boot and alarm test etc.
Pending Items	Alarm log to be acknowledged

- You can select multiple items.
- To deselect an item, tap its checkbox again.

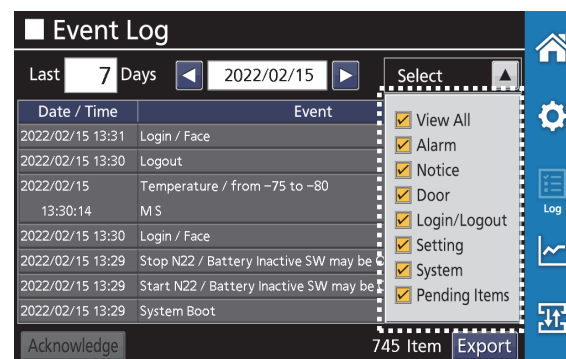

EVENT LOG

Notes:

- When all the event log items are selected, “View All” is displayed at the filtering status indication. When specific event log items are selected, “Filter On” is displayed there.
- You can scroll up and down the screen to view the items on the next or previous page using the scroll buttons.

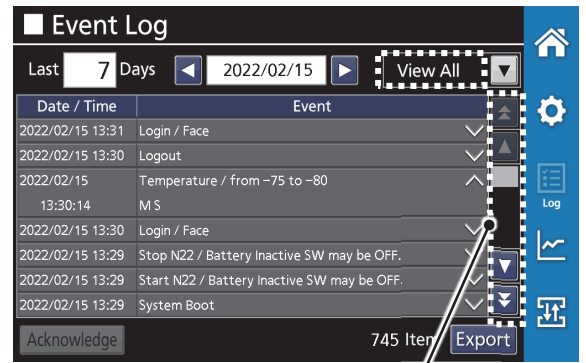

Scroll up and down

7. After checking the logs, tap the Home button in the sidebar menu.
 - ▶ The screen returns to the Home screen.

Viewing and acknowledging pending items

When there was an alarm status such as a high/low alarm or a power failure alarm but the alarm status was spontaneously cleared, the past alarm event (pending item) is notified by the indication of the yellow circle on the upper right part of the event log button.



When the notification is indicated, check the alarm and acknowledge it by following the steps below.

1. Tap the event log button  in the sidebar menu.
 - ▶ The Event Log screen showing the pending items is displayed.
2. Tap the event to be acknowledged.
 - ▶ The event line is highlighted in yellow.

3. After checking the event, tap the Acknowledge button*.
 - ▶ The event line disappears.

Notes:

- You can select only one line to acknowledge the event.
- The disappeared event is moved to the list of Alarm messages.

4. After acknowledgement, tap the Home button in the sidebar menu.
 - ▶ The screen returns to the Home screen.

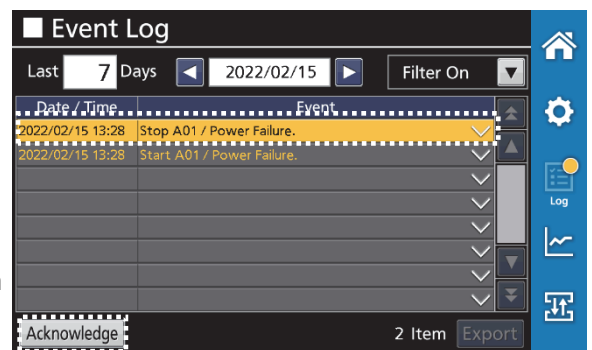

*General users cannot select the Acknowledge button.

Exporting event log data

The event log data displayed on the Event Log screen can be exported to a USB flash drive inserted into the USB port in the CSV format.

When the security mode is set to ON and a user is logged in as a user role, the user cannot export event log data.

1. Insert a USB flash drive into the USB port.

For supported USB flash drives, refer to “10. USB ports (at the lower part of the control panel and right side of the unit)” on page 15.

2. Tap the event log button  in the sidebar menu.

▶ The Event Log screen is displayed.

3. Tap the base date input field on the Event Log screen.

▶ The date input window is displayed.

4. Tap the ▲/▼ buttons to enter the date and tap the OK button.

▶ The Event Log screen is displayed.

Note:

Tapping ◀ and ▶ buttons can display the previous date and next date respectively.

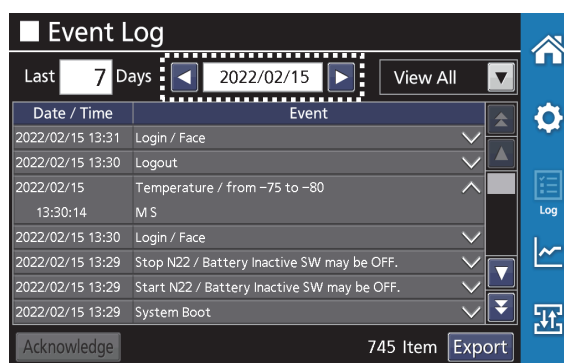

5. Tap the number of days input field.

▶ The numeric input window is displayed.

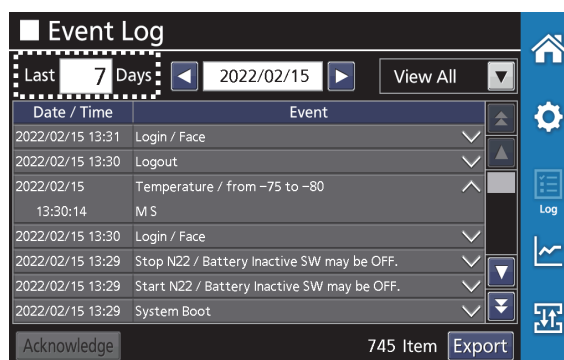

6. Enter the number of days you want to display the events that occurred on and before the base date specified in step 3.

7. Tap the Filtering item selection pull-down and select the event types you want to export.

▶ The selected type of events occurred during the selected period of days are displayed.

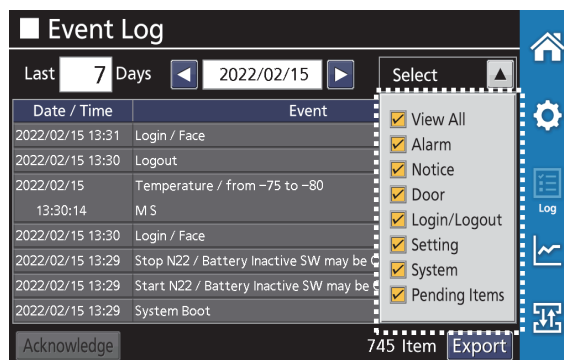

EVENT LOG

8. Tap the Export button at the lower right part of the Event Log screen.

▶ Export of the selected event log data starts.

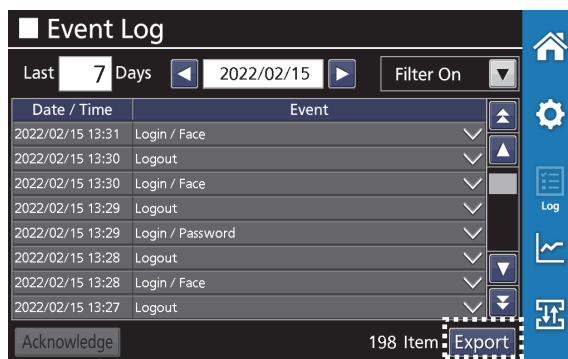

9. Tap the OK button on the Information message indicating that the export has been completed.

▶ The Event Log screen is displayed.

A folder named “log” is created in the USB flash drive and the exported data file is saved in the folder in CSV format.

The file name consists of the unit name, date (YY/MM/DD or DD/MM/YY), and type (AllEvent or Event). The date format specified on the Display screen is used for the date (see page 66).

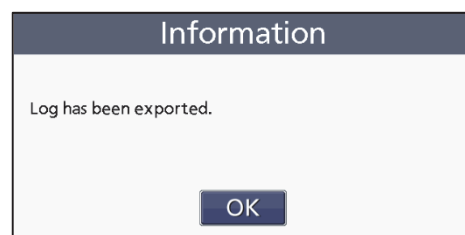

Examples of the file names are as follows:

The data is exported with the unit name “A00001” and the period is last 4 days from March 4 in 2022.

Filtering item	YY/MM/DD	DD/MM/YY
View All	A00001_20220301_20220304_AllEvent.csv	A00001_01Mar2022_04Mar2022_AllEvent.csv
Filter On	A00001_20220301_20220304_Event.csv	A00001_01Mar2022_04Mar2022_Event.csv



The data is exported with the unit name “A00001” and the period is last 1 day from March 1 in 2022.

Filtering item	YY/MM/DD	DD/MM/YY
View All	A00001_20220301_AllEvent.csv	A00001_01Mar2022_AllEvent.csv
Filter On	A00001_20220301_Event.csv	A00001_01Mar2022_Event.csv

Notes:

- User names are not exported. Instead, registration numbers of users are exported.
- If there is an existing same name file, the old file is overwritten with a new file.
- The event log data stored in the freezer is not deleted even if the event log data is exported to the USB flash drive.

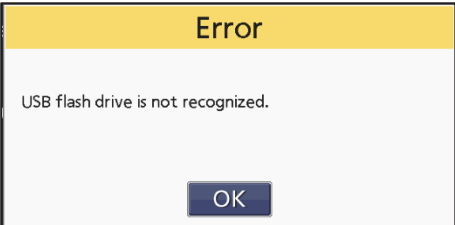
- If an error occurs, one of the following Error messages appears.

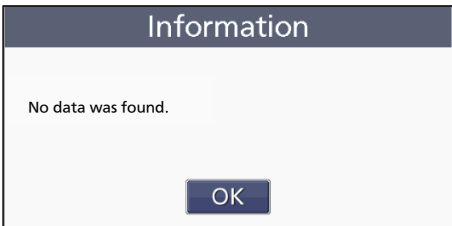
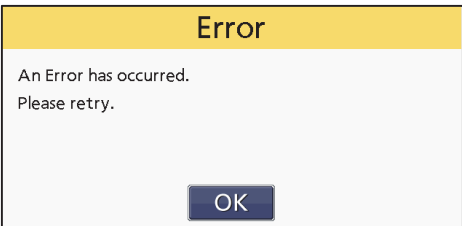
<ul style="list-style-type: none"> • The USB flash drive is not inserted into the USB port. • The USB flash drive is not inserted properly. • The USB flash drive is not formatted in FAT16 or FAT32 format.  <p>▶ Tap the OK button and check if the USB flash drive is inserted into the USB port correctly and check the file system format.</p>	<ul style="list-style-type: none"> • There is not enough free space in the USB flash drive.  <p>▶ Tap the OK button and check the memory capacity of the USB flash drive.</p>
<ul style="list-style-type: none"> • The data during the specified period does not exist.  <p>▶ Tap the OK button and check the specified data.</p>	<ul style="list-style-type: none"> • An Error has occurred during the export process.  <p>▶ Tap the OK button and retry.</p>

10. Remove the USB flash drive from the USB port.

11. Tap the Home button in the sidebar menu.

▶ The screen returns to the Home screen.

OPERATION LOG CHART

On the Chart screen, the operation logs stored in the freezer can be displayed in charts.

- Operation log type: temperature log, outer door status log
- Up to about 200 days' operation log data can be stored (fixed log interval of every two minutes). When the amount of data exceeds the maximum size, the oldest log data is overwritten with the new data.
- When the battery switch for power failure alarm is turned on and the battery capacity is remaining, the operation log data continues to be recorded even during a power failure.

Chart screen

On the Chart screen, you can see the operation log data in chart format. The Chart screen consists of the following items.

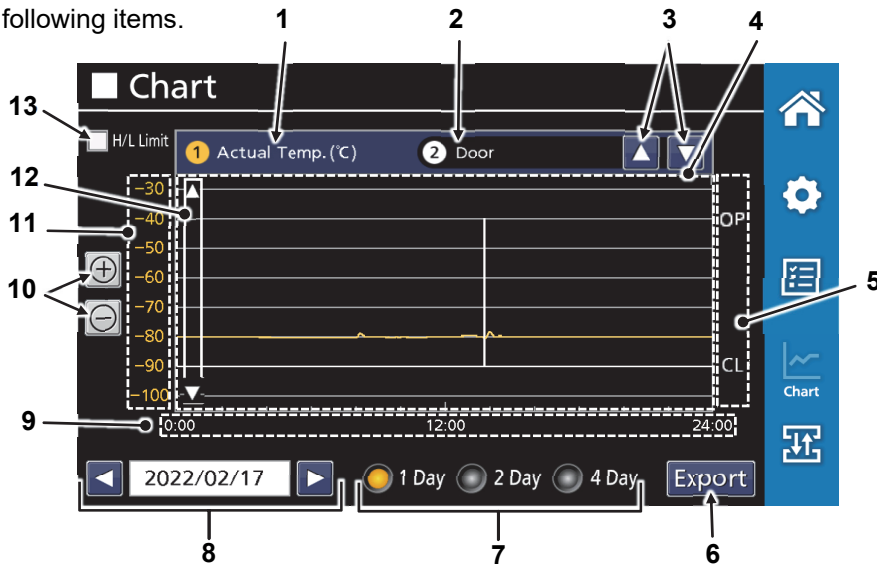

No.	Item	Details
1	Temperature log chart indication	The temperature log chart is always displayed.
2	Door status log chart indication	Indicates that the door status log chart is displayed or not. Door status log chart indication: Door: The door status log chart is displayed. Not Selected: The door status log chart is not displayed
3	Chart selection buttons.	Tapping the ▲ ▼ buttons can select whether or not to display the door status log chart. You cannot select to display only the door status log chart.
4	Chart display area	Each chart is displayed in this area. The temperature log chart is shown with a yellow line and the door status log chart is shown with a white line.
5	Door status axis	Indicate the status of the outer door. OP: Door is opened CL: Door is closed.
6	Export button*	Tapping this button exports the temperature log data and outer door status log data to a USB flash drive in CSV format.
7	Period setting	Select the period of days you want to see the log data on and before the date specified at 8 (base date) shown in the above figure. 1 Day: Only the base date 2 Day: The base date and the previous day 4 Day: Last four days including the base date
8	Base date	Tapping the input field displays the data input window for entering the base date for selecting the period of days you want to see log data. Tapping ◀ and ▶ buttons can display the previous date and next date respectively.
9	Time axis	Indicates time. When 2 Day or 4 Day duration is selected, date is also displayed under the time.

No.	Item	Details
10	Scale up/down buttons	Tapping the + button enlarges the scale of the vertical axis. Tapping the - button reduces the scale of the vertical axis.
11	Temperature axis	Indicates the temperature in the freezer.
12	Temperature log chart scroll buttons	Tapping the ▲ ▼ buttons can scroll up and down the temperature log chart.
13	High/low alarm setting value indication	Selecting this checkbox shows high/low alarm setting values with green lines in the chart.

* When the security mode is set to ON, the user logged in as a general user cannot use the Export button.

Displaying operation log chart

The operation log charts can be displayed by selecting the period and the types.

1. Tap the chart button  in the sidebar menu.
▶ The chart screen is displayed and the temperature log chart is shown.

2. Tap the chart selection button on the Chart screen to select whether or not to display the door status log chart.

3. Tap the base date input field on the Chart screen.
▶ The date input window is displayed.

4. Tap the ▲/▼ buttons to enter the date and tap the OK button.
▶ The Chart screen is displayed.

Note:

Tapping ◀ and ▶ buttons can display the previous date and next date respectively.

5. Tap the period selection radio button to select the period you want to see the operation log data on and before the base date.
▶ The operation log data within the specified period is displayed in the chart.

6. Tap the Home button in the sidebar menu.
▶ The screen returns to the Home screen.

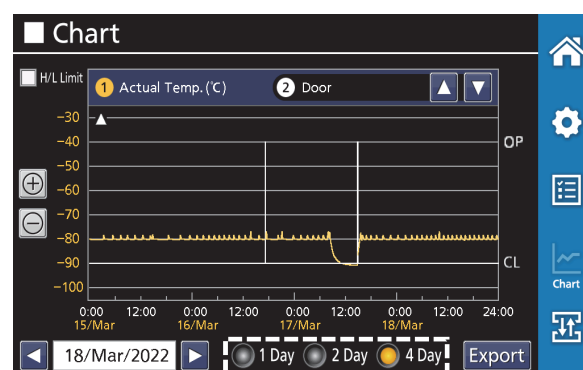
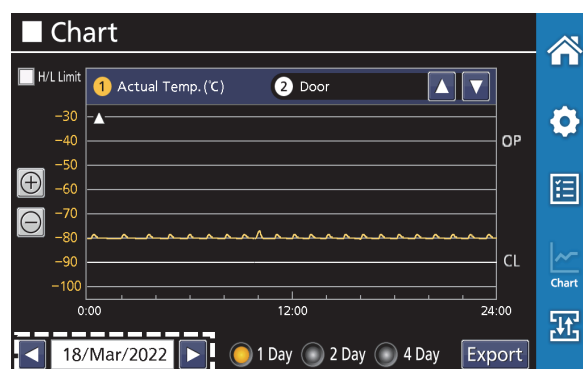
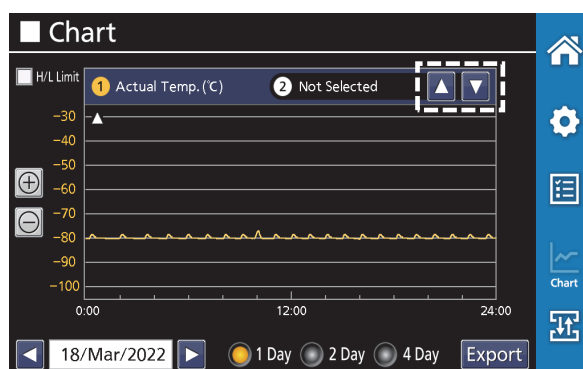

OPERATION LOG CHART

Exporting operation log data

The operation log data (temperature log and outer door status log) can be exported to a USB flash drive inserted into the USB port in the CSV format.

When the security mode is set to ON and a user is logged in as a user role, the user cannot perform export operation (refer to page 26).

Note: The temperature log data and the outer door status log data is exported together. You cannot export each data separately.

1. Insert a USB flash drive into the USB port.
For supported USB flash drives, refer to “10. USB ports (at the lower part of the control panel and right side of the unit)” on page 15.

2. Tap the chart button  in the sidebar menu.
▶ The Chart screen is displayed and the temperature log chart is shown.

3. Select the period of operation log data.
▶ The operation log data during the selected period is displayed.

4. Tap the Export button at the lower right part of the Chart screen.
▶ Export of the operation log data starts.

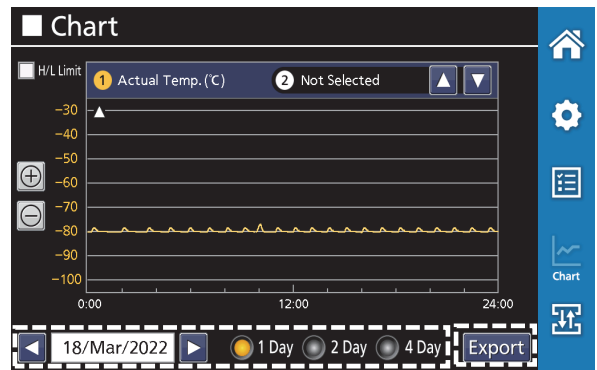

5. Tap the OK button on the Information message indicating that the export has been completed.
▶ The Chart screen is displayed.

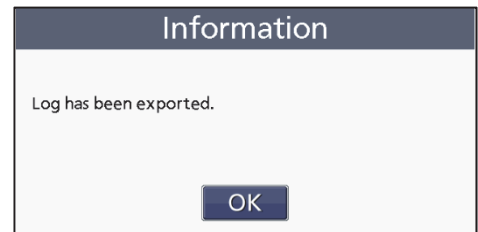

A folder named “log” is created in the USB flash drive and the exported data file is saved in the folder in CSV format.

The file name consists of the unit name, date (YY/MM/DD or DD/MM/YY), and type (Data). The date format specified on the Display screen is used for the date (see page 66).

Examples of the file names are as follows:

The log data is exported with the unit name “A00001” and the period is last 4 days from March 4 in 2022.

YY/MM/DD	DD/MM/YY
A00001_20220301_20220304_Data.csv	A00001_01Mar2022_04Mar2022_Data.csv

The log data is exported with the unit name “A00001” and the period is last 1 day from March 1 in 2022.

YY/MM/DD	DD/MM/YY
A00001_20220301_Data.csv	A00001_01Mar2022_Data.csv

Notes:

- If there is an existing same name file, the old file is overwritten with a new file.
- The operation log data stored in the freezer is not deleted even if the operation log data is exported to the USB flash drive.
- If an export error occurs, one of the Error messages on page 75 appears.

6. Remove the USB flash drive from the USB port.

7. Tap the Home button in the sidebar menu.
▶ The screen returns to the Home screen.

IMPORTING/EXPORTING DATA

Various data stored in the freezer can be exported to a USB flash drive inserted into the USB port. Also, the exported user account data and freezer setting data can be imported to a different similar type model freezer to use the same accounts and setting as the original freezer. For the freezer models that can import such data, contact our sales representative or agent. When the security mode is set to ON and a user is logged in as a user role, the user cannot import or export data (refer to page 26).

- Exportable data: log data, user account data*, freezer setting data*
- Importable data: user account data*, freezer setting data*

*Details of the user account data and freezer setting data

User account data	User ID, user name, password, user role, NFC card/device data *Face recognition data cannot be imported or exported for security reasons.
Freezer setting data	Temperature, high/low alarm, alarm delay, door delay, ring back, remote alarm, brightness (active/sleep), sleep, security settings (excluding the security mode ON/OFF setting), DAQ (excluding DAQ ID), format setting for date & time

Notes:

When tapping the Import/Export button to display the Import/Export screen:

- if the screen lock is set to ON, the Password input window is displayed. Enter the screen lock password to proceed (pages 64 and 65).
- if the security mode is set to ON and you are logged out, the following Information message is displayed. Tap the OK button and login as an administrator user.

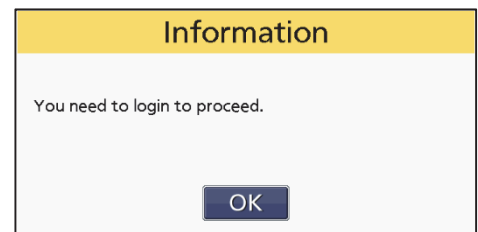

Exporting log data

You can export log data stored in the freezer to a USB flash drive inserted into the USB port in CSV format.

1. Insert a USB flash drive into the USB port.

For supported USB flash drives, refer to "10. USB ports (at the lower part of the control panel and right side of the unit)" on page 15.

2. Tap the Import/Export button in the sidebar menu.

► The Import/Export screen is displayed.

3. Select types of the log data (Item) and date range (Range) of the data to be exported.

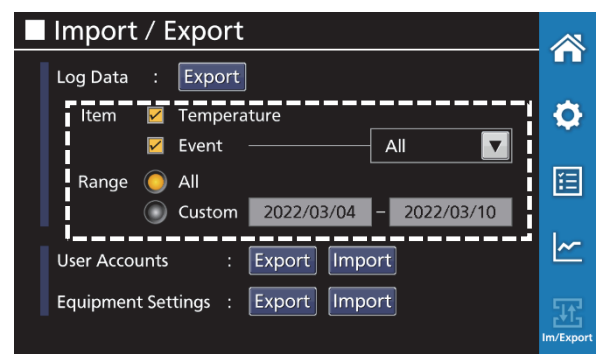

IMPORTING/EXPORTING DATA

Details of setting:

Item	Type	Details	
Item	Temperature	When this checkbox is selected, temperature log data and outer door status log data is exported.	
	Event log	When this checkbox is selected, event log data is exported. You can select the logs to be exported by selecting the items form the dropdown list.	
	All	All event logs	Tap the item selection pull-down button ▼ and select the event types you want to export from the dropdown list. You can select multiple event types.
	Alarm	Alarm message log	
	Notice	Notice message log	
	Door	Outer door open/close status log	
	Login/Logout	Login/logout log	
Setting	Setting button access log		
System	Log for boot and alarm test etc.		
Range	All	All data stored	Tap the All or Custom radio button.
	Custom	Data during specified period	If you tap the Custom radio button specify the start date and end date by tapping the date input field.

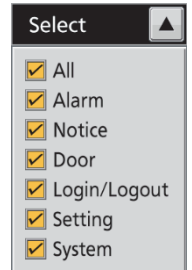

4. Tap the Export button at the upper part of the Import/Export screen.

▶ Export of the selected type of data starts.

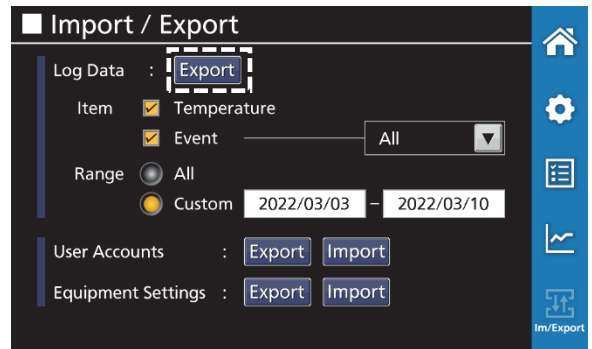

5. Tap the OK button on the Information message indicating that the export has been completed.

▶ The Import/Export screen is displayed.

A folder named “log” is created in the USB flash drive and the exported data file is saved in the folder in CSV format.

The file name consists of the unit name, date (YY/MM/DD or DD/MM/YY), and type (AllData, AllEvent, or Event). The date format specified on the Display screen is used for the date (see page 66).

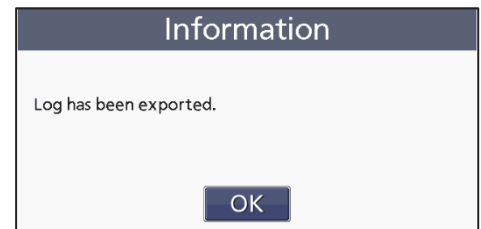

Examples of the file names are as follows:

The data is exported with the unit name “A00001” and ALL (January 1 in 2002 to March 30 in 2022) selected.

Item	Exported data	Date format	File name
Temperature	Temperature and door status	YY/MM/DD	A00001_20220101_20220330_AllData.csv
		DD/MM/YY	A00001_01Jan2022_30Mar2022_AllData.csv
Event - All	All event logs	YY/MM/DD	A00001_20220101_20220330_AllEvent.csv
		DD/MM/YY	A00001_01Jan2022_30Mar2022_AllEvent.csv
Event - Select	Selected event logs	YY/MM/DD	A00001_20220101_20220330_Event.csv
		DD/MM/YY	A00001_01Jan2022_30Mar2022_Event.csv

The data is exported with the unit name "A00001" and Custom (March 1 in 2022) selected.

Item	Exported data	Date format	File name
Temperature	Temperature and door status	YY/MM/DD	A00001_20220301_AllData.csv
		DD/MM/YY	A00001_01Mar2022_AllData.csv
Event - All	All event logs	YY/MM/DD	A00001_20220301_AllEvent.csv
		DD/MM/YY	A00001_01Mar2022_AllEvent.csv
Event - Select	Selected event logs	YY/MM/DD	A00001_20220301_Event.csv
		DD/MM/YY	A00001_01Mar2022_Event.csv

Notes:

- If there is an existing same name file, the old file is overwritten with a new file.
- The log data stored in the freezer is not deleted even if the log data is exported to the USB flash drive.
- If an export error occurs, one of the Error messages on page 75 appears.

6. Remove the USB flash drive from the USB port.

7. Tap the Home button in the sidebar menu.

▶ The screen returns to the Home screen.

Exporting user account data and freezer setting data

The user account data and freezer setting data stored in the freezer can be exported to a USB flash drive inserted into the USB port in BIN format. The data exported to the USB flash drive can be imported to a different similar model freezer to use the same setting as the original freezer.

When the security mode is set to OFF, you cannot export user account data.

1. Insert a USB flash drive into the USB port.

For supported USB flash drives, refer to "10. USB ports (at the lower part of the control panel and right side of the unit)" on page 15.

2. Tap the Import/Export button  in the sidebar menu.

▶ The Import/Export screen is displayed.

3. Tap the Export button (either for User Accounts or Equipment Settings).

▶ Export of the selected data starts.

User Accounts: user account data

Equipment Settings: freezer setting data

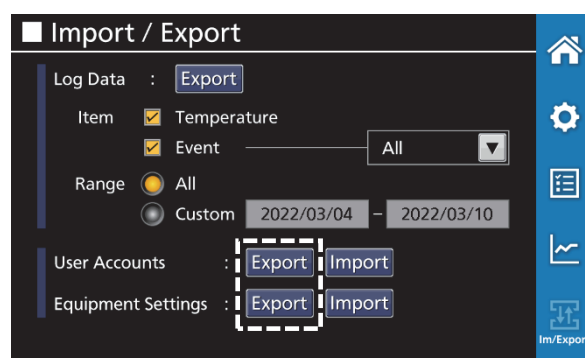

4. Tap the OK button on the Information message indicating that the export has been completed.

- In the case of user account data

A folder named "account" is created in the USB flash drive and the exported data file is saved in the model name (e.g. "MDF-DU703VH") folder in BIN format.

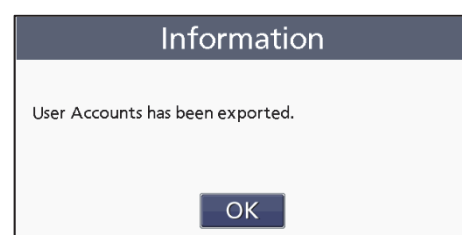

IMPORTING/EXPORTING DATA

- In the case of freezer setting data
A folder named “setup” is created in the USB flash drive and the exported data file is saved in the model name (e.g. “MDF-DU703VH”) folder in BIN format.

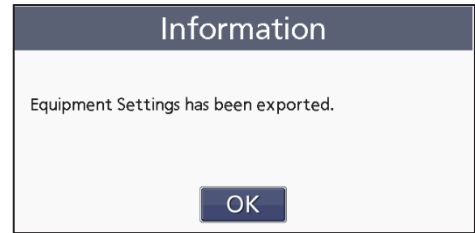

Examples of the file names are as follows:

Data	Folder name	File name
User account data	account¥MDF-DU703VH	account_MDF-DU703VH.bin
Freezer setting data	setup¥MDF-DU703VH	setup_MDF-DU703VH.bin

Notes:

- If there is an existing same name file, the old file is overwritten with a new file.
- The user account data and freezer setting data stored in the freezer is not deleted even if the data is exported to the USB flash drive.
- If an export error occurs, one of the Error messages on page 75 appears.

5. Remove the USB flash drive from the USB port.

6. Tap the Home button in the sidebar menu.

▶ The screen returns to the Home screen.

Note:

Due to unexpected trouble, data may be lost. To prepare for that case, regular backups of the user account data and freezer setting data in safe storage are recommended.

Importing user account data

The user account data exported from a different supported similar model freezer can be imported into this freezer to use the same accounts.

When the security mode is set to OFF, you cannot import user account data.

<p>CAUTION</p>	<ul style="list-style-type: none"> • When the data is imported, the data on this freezer is replaced with the imported data. • When there is the same account data on the original freezer and on the destination freezer and both have the same face recognition data, the face recognition data on the destination freezer remains. Other face recognition data on the destination freezer is deleted when user account data is imported.
-----------------------	---

1. Insert the USB flash drive including the user account data file (account.bin) into the USB port.

2. Tap the Import/Export button in the sidebar menu.

▶ The Import/Export screen is displayed.

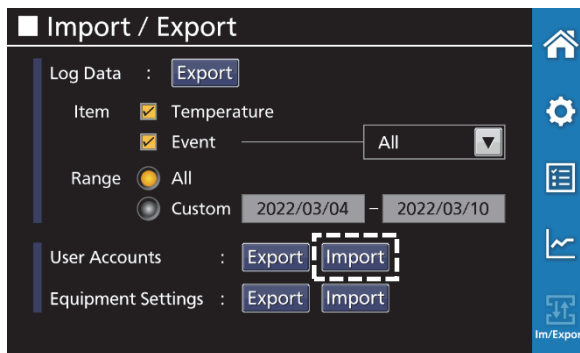

3. Tap the Import button at the User Accounts item on the Import/Export screen.

▶ The Information message indicating that the existing user account data in the freezer will be replaced (overwritten) and you need to log in as the user who exported the user account data is displayed.

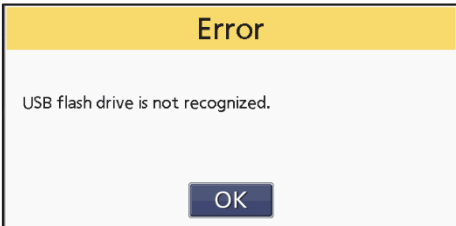

Note:

• If an error occurs, one of the following Error messages appears.

<ul style="list-style-type: none"> • The USB flash drive is not inserted into the USB port. • The USB flash drive is not inserted properly.  <p>▶ Tap the OK button and check if the USB flash drive is inserted into the USB port correctly.</p>	<ul style="list-style-type: none"> • There is no user account data in the USB flash drive.  <p>▶ Tap the OK button and check if there is an account.bin file in the USB flash drive.</p>
---	--

4. Tap the OK button.

▶ The Login window is displayed.

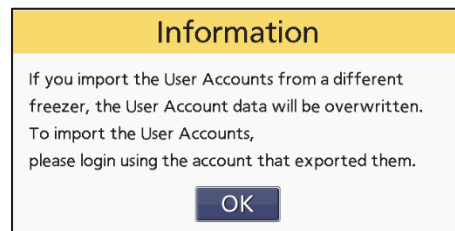

5. Select the Password or NFC (if installed) radio button and login as the user who exported the user account data, and then tap the OK button.

▶ Import of the account data starts.

Notes:

- You cannot select the Face Recog radio button.
- If the authentication fails, the following information message is displayed. Tap the OK button and try again.

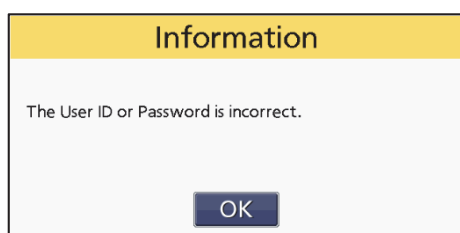
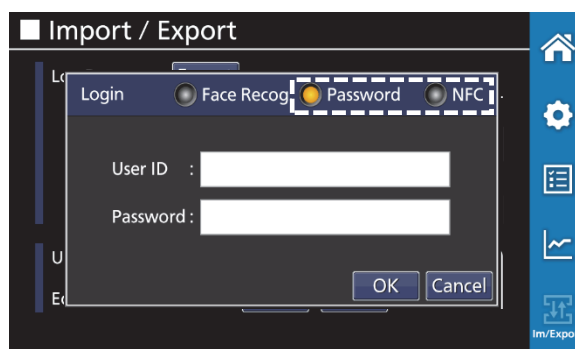

IMPORTING/EXPORTING DATA

- 6. Tap the OK button on the Information message indicating that the import has been completed.
▶ The screen returns to the Import/Export screen.

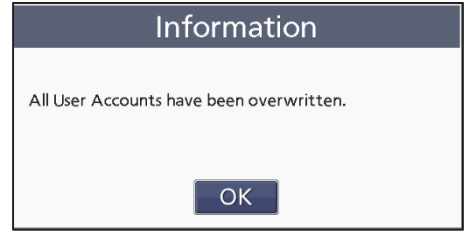

Note:
If the import fails, the following Error message is displayed. Tap the OK button and return to Step 3.

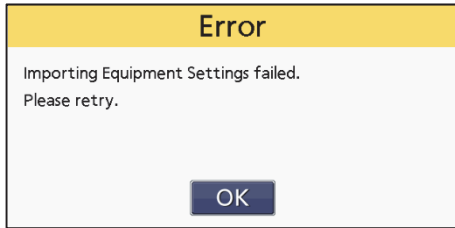

- 7. Remove the USB flash drive from the USB port.
- 8. Tap the Home button in the sidebar menu.
▶ The screen returns to the Home screen.

Importing freezer setting data

The freezer setting data exported from a different supported model freezer can be imported into this freezer to use the same settings as the freezer.

CAUTION When the data is imported, the data on this freezer is replaced with the imported data.

- 1. Insert the USB flash drive including the freezer setting data file (setup.bin) into the USB port.
- 2. Tap the Import/Export button  in the sidebar menu.
▶ The Import/Export screen is displayed.
- 3. Tap the Import button at the Equipment Settings item on the Import/Export screen.
▶ The Confirm message asking if you want to overwrite the existing freezer settings is displayed.

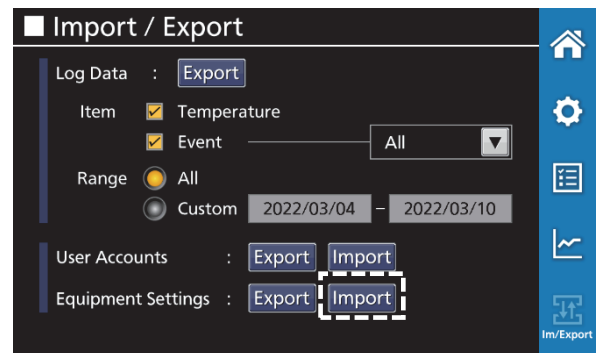

Note:

- If an error occurs, one of the following Error messages appears.

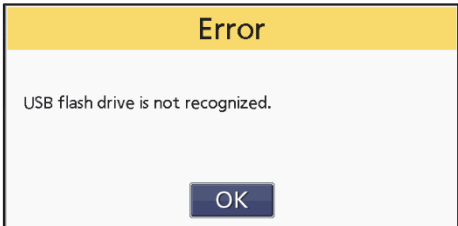
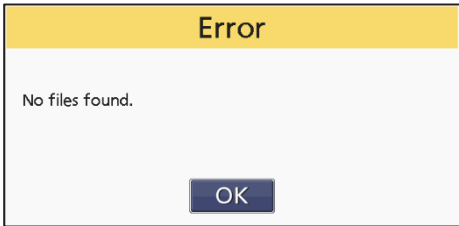
<ul style="list-style-type: none"> • The USB flash drive is not inserted into the USB port. • The USB flash drive is not inserted properly.  <p>▶ Tap the OK button and check if the USB flash drive is inserted into the USB port correctly.</p>	<ul style="list-style-type: none"> • There is no freezer setting data in the USB flash drive.  <p>▶ Tap the OK button and check if there is a setup.bin file in the USB flash drive.</p>
--	---

4. Tap the Yes button.

- ▶ Import of the freezer setting data starts.

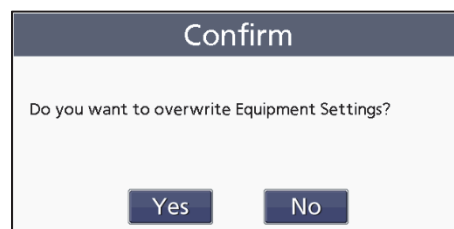
**5.** Tap the OK button on the Information message indicating that the import has been completed.

- ▶ The screen returns to the Import/Export screen.

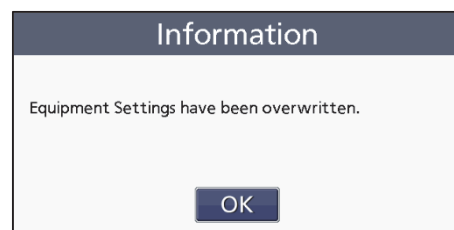
**Note:**

If the import fails, the following Error message is displayed. Tap the OK button and return to Step 3.

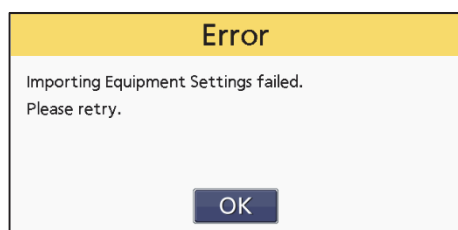
**6.** Remove the USB flash drive from the USB port.**7.** Tap the Home button in the sidebar menu.

- ▶ The screen returns to the Home screen.

5. MAINTENANCE AND TROUBLESHOOTING

ALARMS AND SELF-DIAGNOSIS

Alarm messages



The cooling performance has been significantly degraded. Thus, the chamber temperature may get considerably higher. Take some measures to protect the stored samples immediately (e.g. transferring the stored samples to another freezer) except when the cause is clear and the chamber temperature can be recovered soon. Turn off the power switch and contact our sales representative or agent.

LCD touch panel Message Display Area	Alarm type, Situation	Audible Alarm	LED & Status Indicator	Temp. Indication	Remote Alarm			
Alarm: Temp Control Failure. A01: Power Failure.	[Power failure alarm] The battery switch for power failure alarm is ON, and under any of the following conditions: •During a power failure •Power switch is OFF •Power supply cord is disconnected.	Intermittent tone	Blinking in red	Normal indication	ON			
Alarm: Temp Control Failure. *1 A02: Compressor Temp Abnormal.	[Compressor temp. abnormal] When the fan motor for cooling the compressor fails or when the ambient temperature is out of the usable environment condition.							
Alarm: Temp Too High. A04	[High temp. alarm] (after set alarm delay time has elapsed) The chamber temperature has exceeded the temp. set point + the value set for High Alarm.			Blinking				
Alarm: Temp Too Low. A05	[Low temp. alarm] (after set alarm delay time has elapsed) The chamber temperature has fallen below the temp. set point - the value set for Low Alarm.							
Alarm: Temp Control Failure. A06: Compressor 'H' Control Failure	[Internal communication error] Compressor control failure due to communication failure with H side inverter.			Normal indication				
Alarm: Temp Control Failure. A07: Compressor 'L' Control Failure.	[Internal communication error] Compressor control failure due to communication failure with L side inverter.							
Alarm: Temp Control Failure. *2 A12: Temperature Controller Failure	[Internal communication error] Communication between LCD touch panel and control substrate is unstable.			No indication		—		
Alarm: Temp Control Failure. *3 A13: Temperature Sensor Error.	[Temperature Sensor disconnected] The thermal sensor has been disconnected.			"----" is blinking		ON		
Alarm: Temp Control Failure. *3 A14: Temperature Sensor Error.	[Temperature Sensor short-circuited] The thermal sensor has been short-circuited.							
Alarm: Temp Control Failure. A15: Cascade Temp Abnormal.	[Cascade temp. abnormal] The cascade temperature has risen during the activation of high temp. alarm.			Intermittent tone		Blinking in red	ON	
Alarm: Temp Under Control. A20: Door Lock Error.	[Door lock error] The outer door has been opened without unlocking (logging in) while electrically locked.							
Alarm: Temp Control Risk. A22: Door Open Alarm	[Door alarm] Outer door is open.							Intermittent tone*4
Alarm: Temp Control Risk. A30: Fan Motor '1' Abnormal.	[Fan motor abnormal] Fan motor 1 failure.			Intermittent tone *5		Blinking in red *5	Normal indication	ON *5
Alarm: Temp Control Risk. A31: Fan Motor '2' Abnormal.	[Fan motor abnormal] Fan motor 2 failure.							
Alarm: Temp Control Risk. A32: Fan Motor '3' Abnormal.	[Fan motor abnormal] Fan motor 3 failure.							
Alarm: Temp Control Risk. A33: Fan Motor '4' Abnormal.	[Fan motor abnormal] Fan motor 4 failure.							

*1: The compressor stops in the case of A02.

*2: Chamber temperature is not displayed in the case of A12. Moreover, the LCD touch panel is unavailable.

*3: The compressor runs continuously in the case of A13 or A14.

If the *1 and *3 situations (A02 and A13/A14) occur at the same time, stopping of the compressor has a higher priority over running continuously.

*4: Activates after set door delay time has elapsed.

*5: Activates two or more of the A30 to A33 alarm situations have occurred.

Notice messages



Cooling performance may have been degraded or there is a possibility of failure other than the cooling performance. When the temperature change is temporarily resulting from user operation, wait for the recovery of chamber temperature. In other cases, if the status is left unsolved, the freezer may malfunction, the chamber temperature may rise, or the malfunction may not be notified. Contact our sales representative or agent.

LCD touch panel Message Display Area	Notice type, Situation	Audible Alarm	LED & Status Indicator	Temp. Indication	Remote Alarm
Notice: Temp Control Risk. N01: Cooling Circuits Overload.	*6 [Overload operation] The chamber temp. has not reached the temp. set point for approx. 5 days or more.	—		Normal indication	
Notice: Temp Under Control. N02: Ambient Temp Abnormal.	*7 [Abnormal ambient temperature] The ambient temp. is over 35 °C or lower than 0 °C.				
Notice: Temp Under Control. N03: Air Intake Port Heater Failure.	[Air Intake Port Heater Failure] Heater failure.	Intermittent tone	Blinking in orange	Blinking	—
Notice: Temp Too High. N04	[High temp. alarm] (during set alarm delay time) The chamber temperature has exceeded the temp. set point + the value set for High Alarm.				
Notice: Temp Too Low. N05	[Low temp. alarm] (during set alarm delay time) The chamber temperature has fallen below the temp. set point - the value set for Low Alarm.				
Notice: Temp Control Risk. N06: Filter Error.	[Filter clogged] The filter has become clogged.				
Notice: Temp Under Control. N12: Cascade Sensor Error.	[Cascade Sensor disconnected] The cascade sensor has been disconnected.				
Notice: Temp Under Control. N13: Cascade Sensor Error.	[Cascade Sensor short-circuited] The cascade sensor has been short-circuited.				
Notice: Temp Under Control. N14: Filter Sensor Error.	[Filter Sensor disconnected] The filter sensor has been disconnected.				
Notice: Temp Under Control. N15: Filter Sensor Error.	[Filter Sensor short-circuited] Filter Sensor short-circuited				
Notice: Temp Under Control. N16: Ambient Temp Sensor Error.	[Ambient Temp Sensor disconnected] The ambient temp. sensor has been disconnected.				
Notice: Temp Under Control. N17: Ambient Temp Sensor Error.	[Ambient Temp Sensor short-circuited] The ambient temp. sensor has been short-circuited.				
Notice: Temp Under Control. N18: Main Battery Charging Failure.	[Battery for power failure alarm Charging Failure] The battery voltage does not increase after a certain period of time.				
Notice: Temp Under Control. N19: Backup Battery Charging Failure.	[Battery for backup cooling system charging failure] The battery voltage does not increase after a certain period of time.				
Notice: Temp Under Control. N20: Exchange a Main Battery.	[Battery for power failure alarm replacement] Total operation time has exceeded about 3 years.				
Notice: Temp Under Control. N21: Exchange a Backup Battery.	[Battery for backup cooling system replacement] Total ON time of the backup cooling system has exceeded about 3 years.				
Notice: Temp Under Control. N22: Battery Inactive, SW may be OFF.	[Check for battery switch for power failure alarm] The battery switch for power failure alarm is OFF.				
Notice: Temp Under Control. N24: Face Recognition Device Error.	[Device communication error (face recognition device)] Cannot communicate with the face recognition device.				
Notice: Temp Under Control. N25: NFC Reader Error.	[Device communication error (NFC reader device)] Cannot communicate with the NFC reader device.				
Notice: Temp Under Control. N30: Fan Motor '1' Abnormal.	[Fan motor abnormal] Fan motor 1 failure.				
Notice: Temp Under Control. N31: Fan Motor '2' Abnormal.	[Fan motor abnormal] Fan motor 2 failure.				
Notice: Temp Under Control. N32: Fan Motor '3' Abnormal.	[Fan motor abnormal] Fan motor 3 failure.				
Notice: Temp Under Control. N33: Fan Motor '4' Abnormal.	[Fan motor abnormal] Fan motor 4 failure.				

*6: In the case of N01, check the following:

- (1) There are too many samples stored in the chamber at a time.
- (2) The door is frequently opened or the door gasket is damaged.
- (3) The chamber temperature should be set to -80 °C or higher.

*7: In the case of N02, check the air conditioning at the installation site. The ambient temperature should be 5 °C to 30 °C.

ALARMS AND SELF-DIAGNOSIS

Alarm and Buzzer Stop button

1. The behaviors of the alarm indication and the ring back function when tapping the Buzzer Stop button are as follows.

● **In the cases other than the door alarm and communication error**

<Setting of the freezer>

Remote alarm setting	Ring back setting
ON: Not linked with Buzzer Stop button	ON
	OFF
OFF: Linked with Buzzer Stop button	ON
	OFF

<Alarm behavior>

Alarm sound from freezer		Remote Alarm	
When Buzzer Stop button is tapped	After the set ring back time has elapsed	When Buzzer Stop button is tapped	After the set ring back time has elapsed
OFF (Alarm is not canceled)	ON	ON	ON (Alarm status is continuing)
	OFF		ON
	ON	OFF (Alarm is not canceled)	ON
	OFF		OFF

Note:

Tapping the Buzzer Stop button when the audible alarm is beeping stops the sound. However, the cause of the alarm is not solved by only tapping this button. Refer to pages 86 and 87 to know the cause of the alarm and solve the problem.

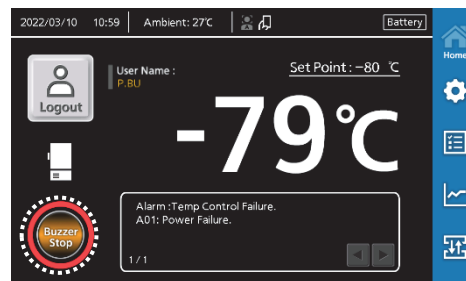

● **In the cases of the door alarm**

<Setting of the freezer>

Remote Alarm setting	Ring Back setting
ON: Not linked with Buzzer Stop button	ON
	OFF
OFF: Linked with Buzzer Stop button	ON
	OFF

<Alarm behavior>

Alarm sound from freezer		Remote Alarm (Door alarm does not link with remote alarm)
When Buzzer Stop button is tapped	After the set ring back time has elapsed	
OFF (Alarm is canceled)	OFF (Alarm is already canceled)	—

2. The alarm indication after the freezer gets out of a high/low alarm condition without user intervention, after recovery from a power failure, and after door lock error is as follows.

Resolved alarm	Home screen	Audible alarm	Status indicator	Power/alarm lamp (LED)	Remote alarm	Event Log button
	Message display area					
High alarm (A04) Low alarm (A05) Power failure alarm (A01) Door lock error (A20)	—	Intermittent tone	Lights in orange	Blinks in orange	—	

Note:

Tapping the Buzzer Stop button stops the alarm sound and the “Buzzer Stop” indication on the Buzzer Stop button disappears.

ROUTINE MAINTENANCE

Cleaning the exterior, interior, and accessories

- Clean the unit once a month. Regular cleaning keeps the unit in good condition.
- Use a dry cloth to wipe down the outside and inside of the unit and all accessories. If the outside panels are dirty, clean them with a diluted neutral dish-washing detergent (using an undiluted solution of detergent may cause the unit's plastic areas to crack. Follow the directions on the detergent for details of dilution.). After wiping the unit or accessories with a diluted detergent, be absolutely sure to wipe the surfaces using a cloth moistened with clean water to remove traces of the detergent. After this, be absolutely sure to wipe the surfaces with a dry cloth.
- Do not use a brush, an acid, a thinner, laundry soap, a powder detergent, or boiling water for cleaning. These may cause damage to painted surfaces or cause perishing of plastic and rubber components. Moreover, do not wipe plastic and rubber components with a volatile material.
- When wiping the control panel with a damp cloth, wipe out the surface so that the droplets do not remain on the surface.
- Do not clean the entire freezer unit using peracetic acid or hydrogen peroxide, or do not disinfect the unit by formalin fumigation.
- Never pour water onto or into the unit. Doing so can damage the electric insulation and cause failure.
- The compressor and other mechanical parts are completely sealed. This unit requires absolutely no lubrication.
- Clean the inside of the inner door to remove the frost and ice at least once a month.
- In order to maintain the unit's intended level of performance, always put back the accessories that have been removed for cleaning.

Cleaning the condenser filter

Clean the condenser filter once a month. A dusty condenser filter may cause shorter compressor life as well as the poor cooling.

Also, if the condenser filter is clogged, notice message (N06: Filter Error) is displayed in the message display area. Clean the condenser filter immediately when this message appears.

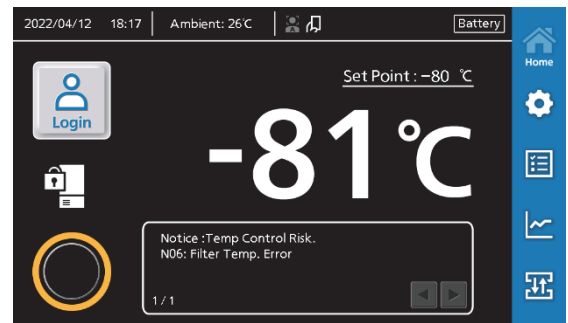

Clean the condenser filter by following the steps below.

1. Open the grille by pulling it to you as shown in the figure.
2. Take out the condenser filter.
3. Wash the condenser filter with water.
4. Put the condenser filter back (set the filter so that the handle of the filter faces to the front) and close the grille.
5. Check that the Notice message disappears from the message display area if it was displayed before.

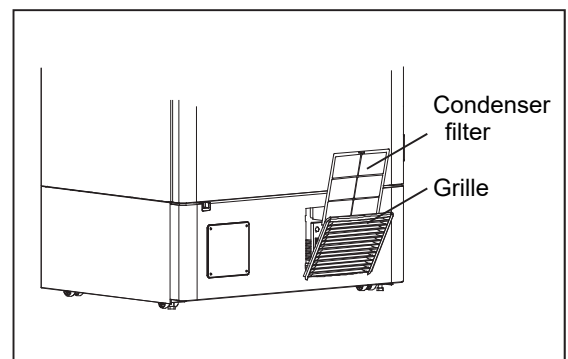

ROUTINE MAINTENANCE

Defrosting the chamber



WARNING

- **Never damage the chamber wall or pipework in the chamber when removing frost.**
It may cause explosions and/or a fire in case of refrigerant leakage.
- **Wear protective gloves when handling frozen items or cleaning the chamber.**
Without gloves, you may get frostbite or get injured by the corners of interior parts. Also, touching or inhaling chemicals or aerosols from around the unit may be detrimental to health.

Frost may accumulate at the upper part in the chamber, around the upper inner part of the inner door, or around the auto air intake port. Excessive accumulation of frost is likely to create gaps between the door and the door gasket, which can degrade the cooling performance. Also, the auto air intake port may not work properly due to the restricted air flow caused by the accumulation of frost around the auto air intake port at the inner side of the door. Remove the frost using the scraper included with the unit before the accumulation becomes too thick. Follow the steps below to defrost when excessive frost builds up in the chamber.



1. Turn off the switch for the backup cooling system (if installed).
2. Turn off the battery switch for power failure alarm.
3. Take out all contents from the freezer and transfer them to another freezer or a container which is refrigerated by liquid carbon dioxide or dry ice.
4. Turn off the power switch for the freezer unit.
5. Open the outer door and inner door. Remove the inner door by lifting up as shown in the figure.
6. Leave the freezer in this state until the frost in the chamber melts.
7. Wipe up the water accumulated at the bottom of the chamber with a dry cloth.
8. After cleaning the chamber, replace the inner door and start up the unit by following “START-UP PROCEDURE” on page 17.
9. Check that the chamber temperature reaches the set temperature and then replace the contents.

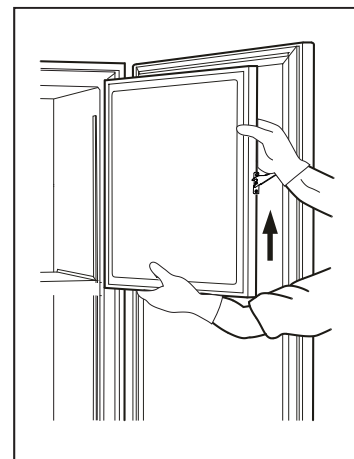

Note:

Do not use a tool with a sharp edge (such as a knife or screw-driver) to remove the frost.

CALIBRATION

During continuous operation, the following service tasks must be performed:

- Perform a temperature calibration at least once a year.

For temperature calibration, contact our sales representative or agent.

REPLACEMENT OF CONSUMABLE PARTS

**WARNING**

- **The replacement of the battery for power failure alarm should be performed by a qualified engineer or service personnel only.**
The replacement of the battery for power failure alarm involves the risk of electric shock.

«Important»

The used battery is a recyclable resource. Do not dispose of the battery. Always follow the procedure for recycling.

Replacing the battery for power failure alarm

To ensure that the power failure alarm is issued when a power failure occurs, replace the battery for power failure alarm about every 3 years. Contact our sales representative or agent for the replacement of the battery when “N20: Exchange a Main Battery.” is displayed in the message display area on the Home screen, and the status indicator and the power/alarm lamp (LED) blink in orange.

- The replacement of the battery for power failure alarm is a paid service.
- The power failure alarm (indication on the LCD display, alarm sound, and remote alarm) will not work when the battery for power failure alarm is flat.
- In the event of a power failure, the battery for power failure alarm is used for displaying the warning “A01: Power Failure” and activates alarm sounds.

Replacing the battery for backup cooling system (option)

To ensure that the backup cooling system can function properly when the temperature in the chamber rises, replace the battery for backup cooling system about every 3 years. Contact our sales representative or agent for the replacement of the battery when “N21: Exchange a Backup Battery.” is displayed in the message display area on the Home screen, and the status indicator and the power/alarm lamp (LED) blink in orange.

- The replacement of the battery for backup cooling system is a paid service.
- The backup cooling system will not function when the battery for backup cooling system is flat.
- When the chamber temperature rises, the backup cooling system is activated by the battery for backup cooling system even during a power failure. The regular replacement of the battery for backup cooling system is important to prevent the rise of chamber temperature in the case of an unexpected situation.

TROUBLESHOOTING

When the freezer does not seem to be working properly, check the following solutions before making a service call.

<Attention>

- If the problem is not resolved by checking the following causes/solutions or if the problem is not shown in the table below, contact our sales representative or agent. If the chamber temperature rose due to the freezer failure, move the samples following the tips on pages 10 and 11.
- If the product needs to be repaired, the registered data (user account data, freezer setting data, and log data) may be lost depending on the types of repair work (e.g. replacement of the substrate). In such a case, we will ask you to back up the data beforehand.

Problem	Cause/Solution
Nothing starts up even after the power is turned on.	<ul style="list-style-type: none"> ■ The unit is not connected to the power supply properly. ■ The capacity and voltage of the power supply is not sufficient. ■ There is a power failure. ■ The circuit breaker has tripped. ■ The fuse has blown.
The compressor does not start up when turning ON the power switch (LCD touch panel is turned ON).	<ul style="list-style-type: none"> ■ The capacity of power supply is not sufficient. When the capacity of power supply is not sufficient to start the compressor, compressor may not start.
The alarm is activated during operation.	<ul style="list-style-type: none"> ■ A user has changed the chamber temperature set point significantly. ■ The door has been kept open for a long time. ■ Containers with a high temperature (load) have been put in the chamber. <p>* In the above cases, the alarm is spontaneously canceled after a while.</p>
	<ul style="list-style-type: none"> ■ The unit is not connected to the power supply properly. ■ The capacity and voltage of the power supply is not sufficient. ■ There is a power failure. ■ The circuit breaker has tripped. ■ The fuse has blown.
	<ul style="list-style-type: none"> ■ If the LCD touch panel is inoperable, turn the power off and then turn it on again.
Cannot set chamber temperature set point.	<ul style="list-style-type: none"> ■ The screen lock has been set to ON. → Turn the screen lock setting to OFF (pages 64 and 65). ■ The user has not logged in as an administrator role when the security mode is set to ON. ■ “DAQ Mode” on the DAQ screen is set to “Remote.”
During the setting operation, the screen returns to the Home screen.	<ul style="list-style-type: none"> ■ The display will automatically return from each screen to the Home screen when there is no touch panel operation for about 90 seconds (auto return function). (When the security mode is set to ON, the Home screen is displayed after the amount of time specified at the Auto Logout (Time) setting on the Security Settings screen has elapsed by the auto return function.)
Excessive noise	<ul style="list-style-type: none"> ■ The floor is not stable. ■ The installation site is not level. ■ The freezer is tilted. ■ The cabinet is touching the surrounding wall.

Problem	Cause/Solution
The chamber does not cool down enough.	<ul style="list-style-type: none"> ■ A large amount of warm materials has been put in the chamber. ■ There is a large amount of frost built in the chamber. ■ The door is frequently opened. ■ The chamber temperature has been set to lower than -86 °C. Although the temperature settable range is between -90 °C to -40 °C, the temperature control range that ensures the cooling performance of this freezer is between -86 °C to -40 °C. ■ The ambient temperature is over 30 °C. The ambient temperature that ensures the cooling performance of this freezer is between 5 °C to 30 °C. ■ The unit is in direct sunlight. ■ The freezer unit is not installed in the appropriate place described in this operating instructions. ■ The ventilation around the unit is blocked. ■ The grille (air intake vent) is blocked. ■ The condenser filter is clogged. ■ There is a nearby heat source. ■ The access port is not covered. → The access port should be covered with insulation and rubber caps when not in use. ■ The door gasket is damaged. → If it is damaged, contact our sales representative or agent for replacement. ■ A foreign substance has got into the door gasket.
The exterior of the freezer is wet with water droplets.	<ul style="list-style-type: none"> ■ When hot humid weather continues or depending on the installation site, the exterior of the freezer may be wet with water droplets. However, this is not a malfunction. When water vapor in the air is cooled down by the cold exterior of the freezer, the vapor condenses into small droplets. Wipe the droplets with a dry cloth.
The motor sound or flowing liquid sound is noisy.	<ul style="list-style-type: none"> ■ Due to the characteristics of the cooling circuit, the sound of the motor or the flowing refrigerant may be heard during operation. Especially a few hours after starting the operation, the sound of the compressor or the flowing refrigerant may be loud, but it is a normal operation.
Cannot export data to the USB flash drive.	<ul style="list-style-type: none"> ■ The USB flash drive is not inserted properly. ■ Data during the specified time period does not exist. ■ The USB flash drive is full. ■ The USB flash drive has not been formatted in FAT16 or FAT32 format. ■ The USB flash drive that requires password is used. ■ The USB flash drive with capacity of more than 32 GB is used.
Cannot import data from the USB flash drive.	<ul style="list-style-type: none"> ■ The USB flash drive is not inserted properly. ■ Data is not included in the USB flash drive.
Face recognition function does not work (low accuracy).	<ul style="list-style-type: none"> ■ The user is wearing a mask. ■ The user is wearing thick-frame glasses. ■ The user's hair is hanging over their eyes. ■ The user's facial hair is covering a part of their mouth. ■ The appearance of the user is significantly different from the face recognition image taken when it was registered such as wearing glasses, hats, or facial hair. ■ Multiple people are in front of the camera. ■ The user is standing too close to or too far from the camera. ■ The user is standing in a too dark place. ■ The camera's lens is dirty. ■ Shift your eyes upward with keeping your head still once the authentication process has started. <p>Note: When the face recognition takes too much time or the recognition does not work properly, clear the currently registered face image and register it again.</p>
Cannot register NFC devices	<ul style="list-style-type: none"> ■ The IC card or the NFC device does not conform to the standards of the NFC reader. ■ The card or device is held over at an incorrect position.

DISPOSAL OF UNIT

Before disposing of the freezer unit with biohazardous danger, decontaminate the unit to the extent possible by the user.

 WARNING	<ul style="list-style-type: none">● If the unit is to be stored unused in an unsupervised area for a long period, ensure that children do not have access to the unit and that doors cannot be closed completely. There may be a risk of child entrapment.
	<ul style="list-style-type: none">● Do not give strong shock or vibration when moving or using the unit. The piping may be damaged, causing a fire.
	<ul style="list-style-type: none">● Flammable and explosive product. The unit contains flammable refrigerant. When repairing or recycling the unit, only trained service personnel should perform the work. Follow the procedure below.<ul style="list-style-type: none">■ Well ventilate the room to prevent refrigerant accumulation.■ Keep fire away when the refrigerant is contained in the product.■ Do not damage or break the pipework.
	<ul style="list-style-type: none">● There is a risk of fire or explosion. Dispose of properly in accordance with federal or local regulations. Flammable refrigerant used.

Recycle of battery

(Only for USA and CANADA)

A sealed lead acid battery that is recyclable powers the product you have purchased. At the end of its useful life, under various state and local laws, it is illegal to dispose of this battery into your municipal waste stream.

L'appareil que vous êtes procuré est alimenté par une batterie au plomb étanche. Après la fin de la vie utile de la batterie, en vertu de diverses réglementations gouvernementales et locales, il est illégal de l'éliminer avec les déchets domestiques ordinaires.



Pb

- USE THE SPECIFIED CHARGER.



- This label is a recycle mark complying with the Taiwanese battery regulation.

(Apenas para a Brasil)



CHUMBO

Baterias de chumbo – ácido:

Atenção sobre a bateria:

- Após o uso, a bateria deverá ser devolvida à rede de assistência técnica ou revendedores para ser encaminhada ao fabricante ou importador. (Resolução CONAMA nsº 401)
- **Riscos a saúde:** O contato com os componentes químicos internos desta bateria pode causar danos a saúde.
- **Riscos ao meio-ambiente:** A destinação final inadequada pode poluir águas e solo.
- **Composição básica:** Chumbo, ácido sulfúrico diluído e plástico.

Deleting personal information (user account data)

If this product was used in the security mode, user account data including personal information was registered and stored in this product. For protecting personal information, be sure to delete the user account data including personal information before disposing of this product. For deleting the user account data, refer to page 41.

6. OPTIONS & SPECIFICATIONS etc.

OPTIONAL COMPONENTS

NFC Reader (MTR-NFC)

The optional NFC reader (MTR-NFC) is a contactless NFC reader. If this reader is installed, users can use IC cards or NFC devices to electrically unlock the outer door (login).

The reader accepts the media conforming to the following communication protocols.

- JIS X 6319-4 (FeliCa communication system)
- ISO/IEC-14443A
- ISO/IEC-14443B
- ISO/IEC-15693

Contact our sales representative or agent for the purchase and installation of the NFC reader.

IC card (MTR-IC)

The optional IC card (MTR-IC) can be used with the optional NFC card reader. Contact our sales representative or agent for the purchase of the IC card.

Material	PVC
Size	85.6 x 54 mm
Thickness	0.78 mm
IC	FeliCaLite-S
Quantity	5

Temperature recorder (MTR-G85A)

The chamber temperature can be recorded and checked by installing the optional temperature recorder.

*The temperature recorder (MTR-G85A) is available only for MDF-DU503/703VHA.

Contact our sales representative or agent for the purchase of the temperature recorder.

Main specifications of temperature recorder

	MTR-G85A
Temperature recording range	-100 °C to +40 °C
Feed speed of recording paper	1-day/1 turn, 7-day/1 turn, 32-day/1 turn (can be switched)
Recording paper	Circular type
Power source	Supplied from the unit

* For installation of the temperature recorder (MTR-G85A), optional recorder sensor cover MTR-DU700SF is required.

OPTIONAL COMPONENTS

Small inner doors (MDF-5ID4/5ID5, MDF-7ID4/7ID5)

For MDF-DU503VH/VHA, small inner doors (MDF-5ID4 (4 doors), MDF-5ID5 (5 doors)) are available as an optional component.

For MDF-DU703VH/VHA, small inner doors (MDF-7ID4 (4 doors), MDF-7ID5 (5 doors)) are available as an optional component.

For the installation, contact our sales representative or agent.

Notes:

- The cooling performance described on page 99 cannot be guaranteed when the small inner doors are installed.

When the small inner doors are installed, the lowest achievable temperature at the center of the chamber is approximately -82 °C (ambient temperature: 30 °C, no load).

- For stable long-term use, it is recommended that the chamber temperature be set to at least 5 °C higher than the lowest achievable temperature (-82 °C). Depending on the actual use conditions, there may be a case where the chamber temperature does not reach the lowest achievable temperature (-82 °C).
- When the small inner doors (MDF-5ID5, MDF-7ID5) are attached, you cannot use the inventory racks (IR-224U, IR-316U).

Backup cooling kit (MDF-UB9)

When the unit stops operation in the event of a power failure, the optional backup cooling kit MDF-UB9 and the liquid CO₂ cylinder can prevent the chamber temperature from rising for several hours by injecting liquid CO₂ into the chamber.

- Contact our sales representative or agent for the purchase and installation of the backup cooling kit.



WARNING

- **Install the unit in a well-ventilated (airy) location**



As with any equipment that uses CO₂ gas, there is a likelihood of oxygen depletion in the vicinity of the equipment. It is important that you assess the work site to ensure there is suitable and sufficient ventilation. If restricted ventilation is suspected, then other methods of ensuring a safe environment must be considered. These may include atmosphere monitoring systems and warning devices with alarm functions.

The injection start temperature of the backup cooling system can be set using the temperature setting knob (page 15). However, the actual injection start temperature slightly deviates from the set injection start temperature.

Activation of the backup cooling system

- Settable range of the injection start temperature: -70 °C~-50 °C

For example, when the injection start temperature of the backup cooling system is set to -70 °C, the injection starts at a temperature of -67 °C to -65 °C and stops at a temperature of -75 °C to -74 °C.

Backup power switch (Page 15)	Status icon (Page 23)	Condition of the backup cooling system	Chamber temperature	Liquid CO ₂
ON	 (White)	Ready to inject	Lower than the injection start temperature.	No injection
			Equal to or higher than the injection start temperature.	Injection starts
OFF	 (Orange)	Not ready to inject (Backup test switch does not work)	Lower than the injection start temperature	No injection
			Equal to or higher than the injection start temperature.	

Note:

Set the injection start temperature of the backup cooling system to at least 10 °C higher than the freezer chamber temperature set point. Otherwise, the liquid CO₂ may be injected continuously into the chamber consuming the liquid CO₂ in the cylinder wastefully.

SETTING OF SHELF STOPPERS WHEN USING INVENTORY RACKS

Optional inventory racks (IR-224U/IR-316U) are available for effectively storing frozen samples in the chamber. For using the inventory racks, make sure to set the shelf stoppers at the positions shown in the following figure. When inserting the inventory rack into the chamber, be careful not to bump the rack against the door gasket and the chamber walls. If they are damaged, the cooling performance of the freezer may deteriorate.

CAUTION

- **Set up or remove the shelf with both hands.**
If the shelf falls down, it may cause injury.
- **When using the inventory racks, be careful not to drop the racks.**
If the rack falls down, it may cause injury or damage to the contents.

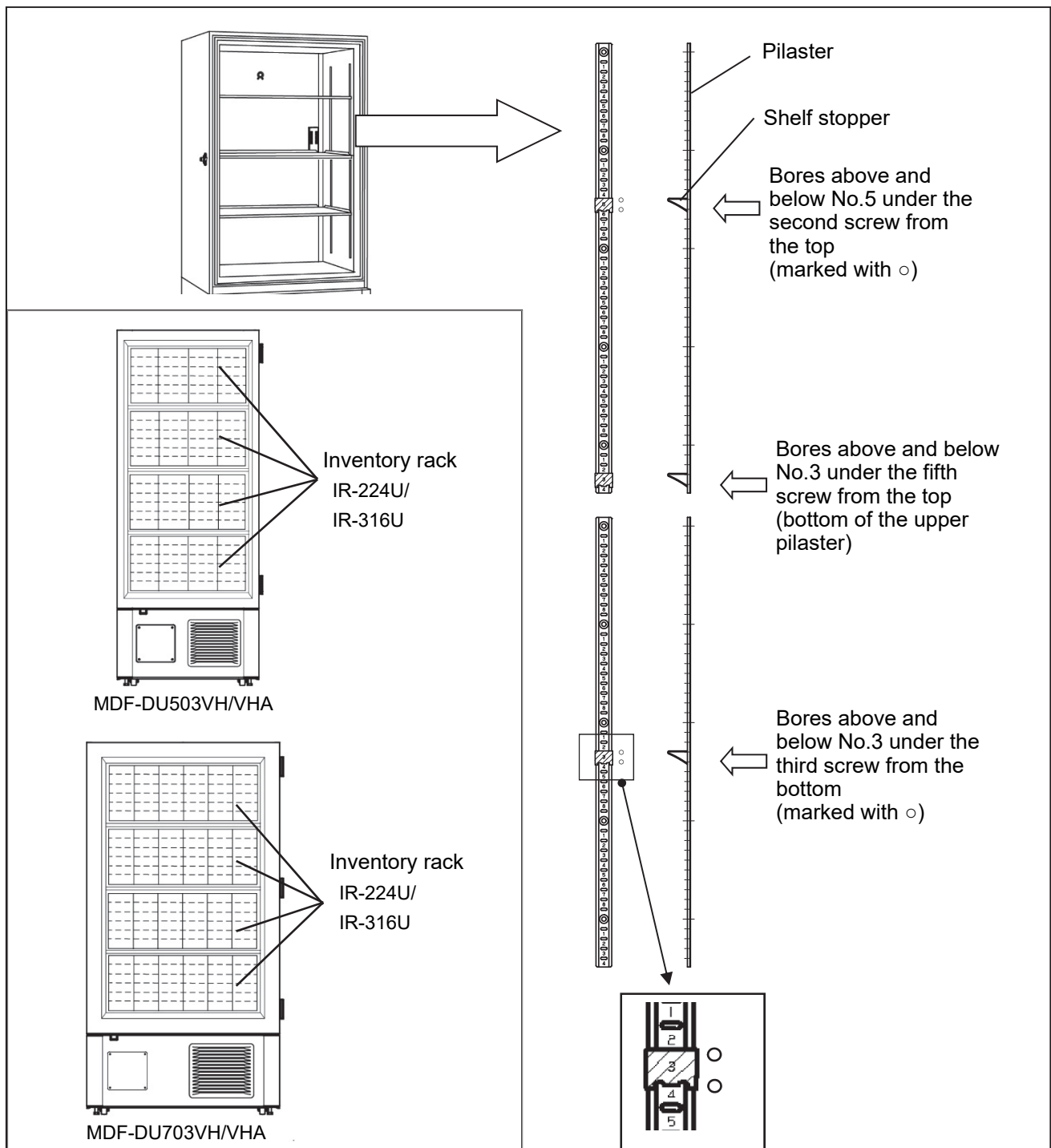

SPECIFICATIONS

Product name		Ultra-Low Temperature Freezer MDF-DU503VH MDF-DU503VHA	Ultra-Low Temperature Freezer MDF-DU703VH MDF-DU703VHA
External dimensions	Width	790 mm (31.1 inch)	1,030 mm (40.6 inch)
	Depth	882 mm (34.7 inch)	882 mm (34.7 inch)
	Height	1,993 mm (78.5 inch)	1,993 mm (78.5 inch)
Internal dimensions	Width	630 mm (24.8 inch)	870 mm (34.3 inch)
	Depth	600 mm (23.6 inch)	600 mm (23.6 inch)
	Height	1,400 mm (55.1 inch)	1,400 mm (55.1 inch)
Effective capacity		528 L (18.6 cu.ft.)	729 L (25.7 cu.ft.)
Exterior		Painted steel	
Interior		Painted steel	
Outer door		Painted steel	
Inner door		Achilles board (2 doors)	
Shelf		Stainless steel, 3 shelves (adjustable) Inner dimension; W615 mm x D534 mm Load; Max. 50 kg/shelf	Stainless steel, 3 shelves (adjustable) Inner dimension; W855 mm x D534 mm Load; Max. 50 kg/shelf
Access port		Inner diameter: 17 mm, 3 positions (back x 1, bottom x 2)	
Insulation		Rigid polyurethane foamed-in place + Vacuum insulation panel	
Compressor		High stage side; Hermetic type, Output; 750 W Low stage side; Hermetic type, Output; 750 W	
Evaporator		High stage side; Cascade type, Low stage side; Tube on sheet type	
Condenser		High stage side: Fin and tube type, Low stage side: Brazing plate	
Refrigerant		High stage side; R-290, Low stage side; R-170	
Temperature controller		Microcomputer control system	
Temperature display		LCD Digital display	
Thermal sensor		Platinum resistance (Pt 1,000 Ω)	
Alarm		High alarm, Low alarm, Power failure alarm, Fan motor alarm, Internal communication error alarm, Compressor temp. abnormal alarm, Temperature Sensor disconnected/ short-circuited alarm, Cascade temp. abnormal alarm, Door alarm, Door lock error alarm	
Remote alarm contact		Allowable contact capacity: DC 30 V, 2 A *1	
Battery		Lead storage battery, DC 12 V, 7,000 mAh, Auto-recharge	
Weight		241 kg (531 lbs)	276 kg (608 lbs)
Accessories		1 set of keys, 1 scraper, 12 shelf stoppers	

*1: Standard signal and interface cables with a maximum length of 30 meters are recommended.

Product name		MDF-DU503VH MDF-DU503VHA	MDF-DU703VH MDF-DU703VHA
Options	Temperature recorder	MTR-G85A (only for MDF-DU503/703VHA) * For installation, recorder sensor cover (MTR-DU700SF) is required.	
	NFC system	NFC reader (MTR-NFC) 5 IC cards (MTR-IC)	
	Rack	Inventory rack (IR-224U, IR-316U)	
		Drawers (MDF-50R)	—
	Backup cooling system	Backup cooling kit (MDF-UB9) ^{*2} For Liquid CO ₂	
	Small inner door	Small inner door (4-door) (MDF-5ID4) Small inner door (5-door) (MDF-5ID5)	Small inner door (4-door) (MDF-7ID4) Small inner door (5-door) (MDF-7ID5)
Communication	Interface board (MTR-L03) ^{*1} for LAN Interface board (MTR-480) ^{*1} for RS-232C/RS-485		

*1: Standard signal and interface cables with a maximum length of 30 meters are recommended.

*2: Settable range of the injection start temperature is -70 °C to -50 °C.

Note:

Refer to the updated catalogue when ordering an optional component.

PERFORMANCE

Product name	Ultra-Low Temperature Freezer MDF-DU503VH	Ultra-Low Temperature Freezer MDF-DU703VH
Model number	MDF-DU503VH-PA	MDF-DU703VH-PA
Cooling performance	-86 °C at the center of the chamber (ambient temperature; 30 °C, no load)*	
Temperature settable range	-90 °C to -40 °C	
Temperature control range	-86 °C to -40 °C (ambient temperature; 30 °C, no load)	
Rated voltage	AC 220 V	
Rated frequency	60 Hz	
Rated power consumption	305 W (Max. 645 W)	360 W (Max. 750 W)
Noise level	52 dB [A] (background noise; 20 dB)	
Maximum pressure	1,800 kPa	1,920 kPa
Heat emission	2,322 kJ/h	2,700 kJ/h
Environmental conditions	Ambient Temperature: 5 °C to 30 °C, Humidity: 80 %R.H. or less	

Product name	Ultra-Low Temperature Freezer MDF-DU503VHA	Ultra-Low Temperature Freezer MDF-DU703VHA
Model number	MDF-DU503VHA-PA	MDF-DU703VHA-PA
Cooling performance	-86 °C at the center of the chamber (ambient temperature; 30 °C, no load)*	
Temperature settable range	-90 °C to -40 °C	
Temperature control range	-86 °C to -40 °C (ambient temperature; 30 °C, no load)	
Rated voltage	AC 115 V	
Rated frequency	60 Hz	
Rated power consumption	305 W (Max. 665 W)	360 W (Max. 785 W)
Noise level	52 dB [A] (background noise; 20 dB)	
Maximum pressure	1,800 kPa	1,920 kPa
Heat emission	2,394 kJ/h	2,826 kJ/h
Environmental conditions	Ambient Temperature: 5 °C to 30 °C, Humidity: 80 %R.H. or less	

* The value for the cooling performance indicates the lowest achievable temperature at the center of the chamber. For stable long-term use, it is recommended that the chamber temperature be set to at least 5 °C higher than the lowest achievable temperature (-86 °C). Depending on the actual use conditions, there may be a case where the chamber temperature does not reach the lowest achievable temperature (-86 °C).

Note:

Data for this product is measured based on our measuring method.

SAFETY ENVIRONMENTAL CONDITIONS

This equipment is designed to be safe at least under the following conditions (based on the IEC 61010-1):

- Indoor use;
- Altitude up to 2,000 m;
- Temperature 5 °C to 40 °C;
- Maximum relative humidity 80 % for temperature up to 31 °C decreasing linearly to 50 % relative humidity at 40 °C;
- Mains supply voltage fluctuations up to ± 10 % of the nominal voltage;
- Transient overvoltages up to the levels of OVERVOLTAGE CATEGORY II;
- Temporary OVERVOLTAGES occurring on the mains supply;
- Applicable pollution degree of the intended environment (POLLUTION DEGREE 2 in most cases);

* The above conditions do not indicate the performance of this product. For the performance of this product, refer to the "PERFORMANCE" section.

SAFETY CHECK SHEET



CAUTION

Please copy and fill out this form before servicing. Hand over the form to the service engineer for their and your safety.

Safety check sheet

1. Stored material

Risk of infection: Yes No Maybe

Risk of toxicity: Yes No Maybe

Risk from radioactive sources: Yes No Maybe

List all potentially hazardous materials that have been stored in this unit:

2. Contamination in the unit

a) Contamination Yes No Maybe

Types of contamination (if any): _____

b) Decontaminated Yes No

Methods used for the decontamination work:

3. Status of the unit

a) The unit is now safe to work on Yes No

b) If the answer is "No,"

Details on the danger: _____

Measures we should take to reduce the danger:

Date:

Signature:

Address, Division:

Telephone:

Product name: Ultra-low temperature freezer	Model No. MDF-	Serial number:	Date of Installation:
--	-------------------	----------------	-----------------------

Please decontaminate the unit yourself before calling the service engineer.

USE OF OPEN-SOURCE SOFTWARE

- This product uses MD5 source code. In accordance with the MD5 license, the copyright, delivery condition, and license statement are shown below.

- RSA Data Security's MD5 License

RSA Data Security, Inc., MD5 message-digest algorithm
Copyright (C) 1991-2, RSA Data Security, Inc. Created 1991. All rights reserved.

License to copy and use this software is granted provided that it is identified as the "RSA Data Security, Inc. MD5 Message- Digest Algorithm" in all material mentioning or referencing this software or this function.

License is also granted to make and use derivative works provided that such works are identified as "derived from the RSA Data Security, Inc. MD5 Message-Digest Algorithm" in all material mentioning or referencing the derived work.

RSA Data Security, Inc. makes no representations concerning either the merchantability of this software or the suitability of this software for any particular purpose. It is provided "as is" without express or implied warranty of any kind.

These notices must be retained in any copies of any part of this documentation and/or software.

- This product uses FreeRTOS source code. In accordance with the MIT license, the copyright, delivery condition, and license statement are shown below.

- MIT License

Copyright (C) 2017 Amazon.com, Inc. or its affiliates. All Rights Reserved.

Permission is hereby granted, free of charge, to any person obtaining a copy of this software and associated documentation files (the "Software"), to deal in the Software without restriction, including without limitation the rights to use, copy, modify, merge, publish, distribute, sublicense, and/or sell copies of the Software, and to permit persons to whom the Software is furnished to do so, subject to the following conditions:

The above copyright notice and this permission notice shall be included in all copies or substantial portions of the Software.

THE SOFTWARE IS PROVIDED "AS IS", WITHOUT WARRANTY OF ANY KIND, EXPRESS OR IMPLIED, INCLUDING BUT NOT LIMITED TO THE WARRANTIES OF MERCHANTABILITY, FITNESS FOR A PARTICULAR PURPOSE AND NONINFRINGEMENT. IN NO EVENT SHALL THE AUTHORS OR COPYRIGHT HOLDERS BE LIABLE FOR ANY CLAIM, DAMAGES OR OTHER LIABILITY, WHETHER IN AN ACTION OF CONTRACT, TORT OR OTHERWISE, ARISING FROM, OUT OF OR IN CONNECTION WITH THE SOFTWARE OR THE USE OR OTHER DEALINGS IN THE SOFTWARE.

PHC Corporation

1-1-1 Sakada, Oizumi-machi, Ora-gun, Gunma 370-0596, Japan

© PHC Corporation 2022



Printed in Japan
LDCL077200-1
J0922-10922