



Stainless Steel Inset **CASEWORK**

Pharmaceutical • Biotech • Medical Device • Cleanroom • Lab • Research





Adjustable Height Tables

- with Pinned Legs20
- with Electronic Drive.....20

Base Units - Sitting Height Cabinets

- with Door/Drawer Combo10
- with Drawer Bank.....9
- with Full-Height Door(s).....9
- with Open Front.....9
- Corner Bases.....10
- Sink Bases.....10

Base Units - Standing Height Cabinets

- with Door/Drawer Combo 6-7
- with Drawer Bank..... 4-5
- with Full-Height Door(s).....4
- with Open Front.....4
- Corner Bases.....8
- Sink Bases.....8

Base Fillers

- Corner Fillers12
- Knee Space Apron Kits11
- Knee Space Panels.....11
- Rear Filler Panels.....12
- Rear Filler Scribes12
- Toe Fillers.....11
- Toe Scribes11

Bench Frames

- Standard.....18
- with Drawer(s)..... 18-19

Healthcare Storage Cabinets

- with Pinned Legs20
- with Electronic Drive.....20

Laboratory Wall Shelves

- Laboratory Wall Shelves13

Pegboards

- Pegboards13

Stainless Steel Countertops

- Stainless Steel Countertops 20-21

Tall Cabinets

- Framed Glass Swinging Tall Cases17
- Open Tall Cases.....16
- Solid Swinging Tall Cases.....16

Upper Cabinets

- Framed Glass Swinging
Wall Cases.....113
- Open Wall Cases.....112
- Solid Swinging Wall Cases.....112

Vertical Storage Cabinets

- Vertical Storage Cabinets.....19

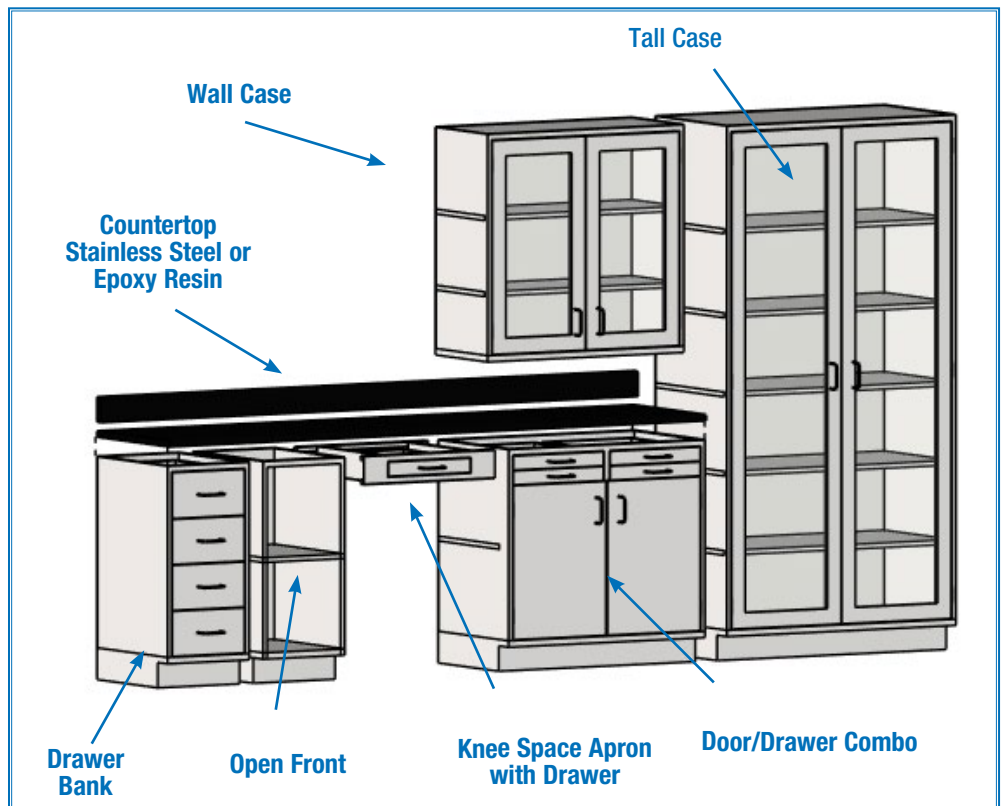

Standard Casework Construction Specifications



casework construction and performance characteristics are in full compliance with SEFA 8M Metal standards.

Base Units - Standing Height Cabinets

with Open Base

- FEATURES:**
- Open Base with interior shelf
 - Standing Height - 35" (889mm) high.
 - 22" (559mm) depth.

depth		width		weight		description	model #
in	mm	in	mm	lbs.	kg		
22"	559	18"	457	74	33.6	open base	SSC-HOB-18
22"	559	24"	610	99	44.9	open base	SSC-HOB-24
22"	559	30"	762	124	56.2	open base	SSC-HOB-30
22"	559	36"	914	133	60.3	open base	SSC-HOB-36
22"	559	48"	1218	149	67.6	open base	SSC-HOB-48

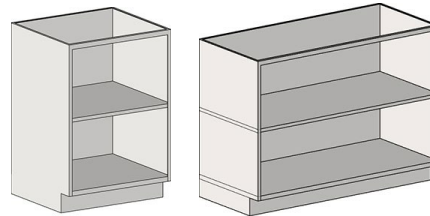

with Full-Height Door(s)

- FEATURES:**
- Full-height hinged door(s) with wire style pull.
 - Intermediate shelf.
 - Standing Height - 35" (889mm) high.
 - 22" (559mm) depth.

depth		width		weight		description	model #
in	mm	in	mm	lbs.	kg		
22"	559	18"	457	99	44.9	left swing door	SSC-HCBL-18
22"	559	18"	457	99	44.9	right swing door	SSC-HCBL-18
22"	559	24"	610	124	56.2	left swing door	SSC-HCBL-24
22"	559	24"	610	124	56.2	right swing door	SSC-HCBL-24
22"	559	30"	762	174	78.9	double doors	SSC-HCB-30
22"	559	36"	914	183	83.0	double doors	SSC-HCB-36
22"	559	48"	1219	199	90.3	double doors	SSC-HCB-48

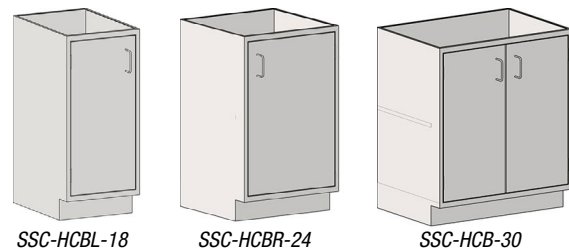

with Single-Bank Drawers

- FEATURES:**
- Units with single-bank full-length drawers.
 - Standing Height - 35" (889mm) high.
 - 22" (559mm) depth.

Four 7" (178mm) Drawers Per Unit

depth		width		weight		no. of drawers	drawer height		model #
in	mm	in	mm	lbs.	kg		in.	mm	
22"	559	18"	457	142	64.4	4	7"	178	SSC-HDB7-18
22"	559	24"	610	167	75.7	4	7"	178	SSC-HDB7-24
22"	559	30"	762	260	117.9	4	7"	178	SSC-HDB7-30
22"	559	36"	914	269	122.0	4	7"	178	SSC-HDB7-36
22"	559	48"	1219	285	129.0	4	7"	178	SSC-HDB7-48



Three 10" (254mm) Drawers Per Unit

depth		width		weight		no. of drawers	drawer height		model #
in	mm	in	mm	lbs.	kg		in.	mm	
22"	559	18"	457	134	60.8	3	10"	254	SSC-HDB10-18
22"	559	24"	610	159	72.1	3	10"	254	SSC-HDB10-24
22"	559	30"	762	244	110.7	3	10"	254	SSC-HDB10-30
22"	559	36"	914	253	114.8	3	10"	254	SSC-HDB10-36
22"	559	48"	1219	269	122.1	3	10"	254	SSC-HDB10-48



Base Units - Standing Height Cabinets

with Single-Bank Drawers

- Units with single-bank full-length drawers.
- Standing Height - 35" (889mm) high.
- 22" (559mm) depth.

FEATURES:

Ten 3" (76mm) Drawers Per Unit

depth		width		weight		no. of drawers	drawer height		model #
in	mm	in	mm	lbs.	kg		in.	mm	
22"	559	18"	457	174	78.9	10	3"	76	SSC-HDB3-18
22"	559	24"	610	199	90.3	10	3"	76	SSC-HDB3-24
22"	559	30"	762	324	146.9	10	3"	76	SSC-HDB3-30
22"	559	36"	914	333	151.0	10	3"	76	SSC-HDB3-36
22"	559	48"	1219	349	158.0	10	3"	76	SSC-HDB3-48

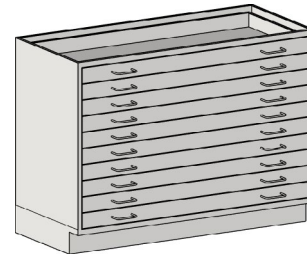

SSC-HDB3-24

Five 6" (152mm) Drawers Per Unit

depth		width		weight		no. of drawers	drawer height		model #
in	mm	in	mm	lbs.	kg		in.	mm	
22"	559	18"	457	149	67.6	5	6"	152	SSC-HDB6-18
22"	559	24"	610	174	78.9	5	6"	152	SSC-HDB6-24
22"	559	30"	762	274	124.3	5	6"	152	SSC-HDB6-30
22"	559	36"	914	283	128.4	5	6"	152	SSC-HDB6-36
22"	559	48"	1219	299	135.6	5	6"	152	SSC-HDB6-48



SSC-HDB6-18

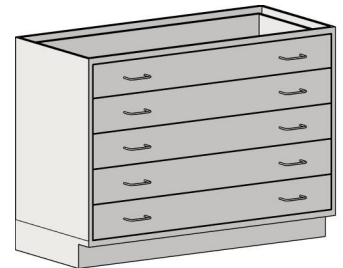

SSC-HDB6-48

with Double-Bank Drawers

- Units with double-bank of drawers.
- Standing Height - 35" (889mm) high.
- 22" (559mm) depth.

FEATURES:

Ten 6" (152mm) Drawers Per Unit

depth		width		weight		no. of drawers	drawer height		model #
in	mm	in	mm	lbs.	kg		in.	mm	
22"	559	30"	762	548	248.6	10	6"	152	SSC-HDBD6-30
22"	559	36"	914	566	256.7	10	6"	152	SSC-HDBD6-36
22"	559	48"	1219	598	271.2	10	6"	152	SSC-HDBD6-48

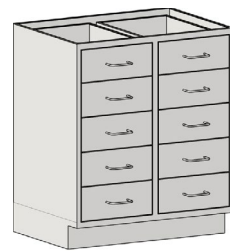

SSC-HDBD6-36



Eight 7" (178mm) Drawers Per Unit

depth		width		weight		no. of drawers	drawer height		model #
in	mm	in	mm	lbs.	kg		in.	mm	
22"	559	30"	762	520	235.9	8	7"	152	SSC-HDBD7-30
22"	559	36"	914	538	244.0	8	7"	152	SSC-HDBD7-36
22"	559	48"	1219	570	258.6	8	7"	152	SSC-HDBD7-48

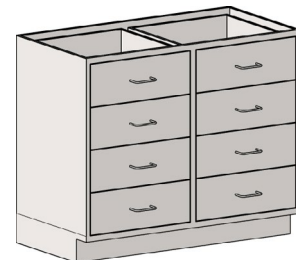

SSC-HDBD7-48

Base Units - Standing Height Cabinets

with Door/Drawer Combination

- Units with hinged door(s) and drawer(s).
- Standing Height - 35" (889mm) high.
- 22" (559mm) depth.

FEATURES:



SSC-HDDL3-18



SSC-HDDLRT3-18

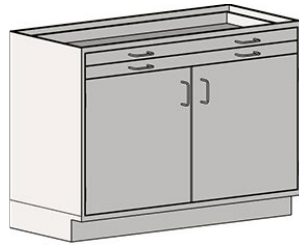

SSC-HDDT3-36

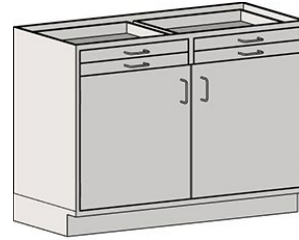

SSC-HDDT3D-36

Units with 3" (76mm) Drawers

depth		width		weight		no. of drawers	drawer height		description	model #
in	mm	in	mm	lbs.	kg		in.	mm		
22"	559	18"	457	94	42.6	2	3"	76	left swing door	SSC-HDDL3-18
22"	559	18"	457	94	42.6	2	3"	76	right swing door	SSC-HDDR3-18
22"	559	24"	610	119	53.9	2	3"	76	left swing door	SSC-HDDL3-24
22"	559	24"	610	119	53.9	2	3"	76	right swing door	SSC-HDDR3-24
22"	559	30"	762	214	97.1	2	3"	76	double doors	SSC-HDDT3-30
22"	559	36"	914	223	101.1	2	3"	76	double doors	SSC-HDDT3-36
22"	559	48"	1219	239	108.4	2	3"	76	double doors	SSC-HDDT3-48
22"	559	30"	762	224	101.6	4	3"	76	double doors	SSC-HDDT3D-30
22"	559	36"	914	233	105.7	4	3"	76	double doors	SSC-HDDT3D-36
22"	559	48"	1219	249	112.9	4	3"	76	double doors	SSC-HDDT3D-48



SSC-HDDL6-18



SSC-HDDLRT6-18

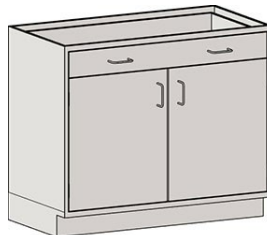

SSC-HDDT6-18

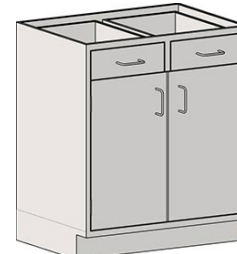

SSC-HDDT6D-30

Units with One or Two 6" (152mm) Drawers

depth		width		weight		no. of drawers	drawer height		description	model #
in	mm	in	mm	lbs.	kg		in.	mm		
22"	559	18"	457	114	51.7	1	6"	152	left swing door	SSC-HDDL6-18
22"	559	18"	457	114	51.7	1	6"	152	right swing door	SSC-HDDR6-18
22"	559	24"	610	139	63.0	1	6"	152	left swing door	SSC-HDDL6-24
22"	559	24"	610	139	63.0	1	6"	152	right swing door	SSC-HDDR6-24
22"	559	30"	762	204	92.5	1	6"	152	double doors	SSC-HDDT6-30
22"	559	36"	914	213	96.6	1	6"	152	double doors	SSC-HDDT6-36
22"	559	48"	1218	229	103.9	1	6"	152	double doors	SSC-HDDT6-48
22"	559	30"	762	214	97.1	2	6"	152	double doors	SSC-HDDT6D-30
22"	559	36"	914	223	101.2	2	6"	152	double doors	SSC-HDDT6D-36
22"	559	48"	1218	239	108.4	2	6"	152	double doors	SSC-HDDT6D-48

Base Units - Standing Height Cabinets

with Door/Drawer Combination (cont.)

FEATURES:

- Units with door(s) and drawer(s).
- Standing Height - 35" (889mm) high.
- 22" (559mm) depth.

Units with Five 6" (152mm) Drawers

depth		width		weight		no. of drawers	drawer height		description	model #
in	mm	in	mm	lbs.	kg		in.	mm		
22"	559	30"	762	209	94.8	5	6"	152	left swing door	SSC-HDDL6-30
22"	559	30"	762	209	94.8	5	6"	152	right swing door	SSC-HDDR6-30
22"	559	36"	914	218	98.9	5	6"	152	left swing door	SSC-HDDL6-36
22"	559	36"	914	218	98.9	5	6"	152	right swing door	SSC-HDDR6-36
22"	559	48"	1219	234	106.1	5	6"	152	left swing door	SSC-HDDL6-48
22"	559	48"	1219	234	106.1	5	6"	152	right swing door	SSC-HDDR6-48

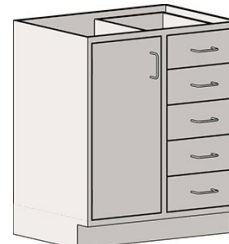

SSC-HDDL6-30

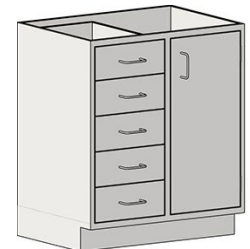

SSC-HDDR6-30

Units with Six 6" (152mm) Drawers

depth		width		weight		no. of drawers	drawer height		description	model #
in	mm	in	mm	lbs.	kg		in.	mm		
22"	559	30"	762	234	106.1	6	6"	152	left swing door	SSC-HDDL6D-30
22"	559	30"	762	234	106.1	6	6"	152	right swing door	SSC-HDDR6D-30
22"	559	36"	914	243	110.2	6	6"	152	left swing door	SSC-HDDL6D-36
22"	559	36"	914	243	110.2	6	6"	152	right swing door	SSC-HDDR6D-36
22"	559	48"	1219	259	117.5	6	6"	152	left swing door	SSC-HDDL6D-48
22"	559	48"	1219	259	117.5	6	6"	152	right swing door	SSC-HDDR6D-48



SSC-HDDL6D-48

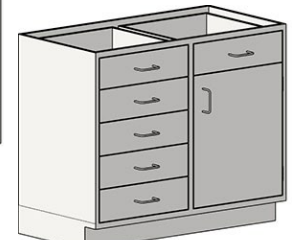

SSC-HDDR6D-48

Units with Four 7" (178mm) Drawers

depth		width		weight		no. of drawers	drawer height		description	model #
in	mm	in	mm	lbs.	kg		in.	mm		
22"	559	30"	762	202	91.6	4	7"	178	left swing door	SSC-HDDL7-30
22"	559	30"	762	202	91.6	4	7"	178	right swing door	SSC-HDDR7-30
22"	559	36"	914	211	95.7	4	7"	178	left swing door	SSC-HDDL7-36
22"	559	36"	914	211	95.7	4	7"	178	right swing door	SSC-HDDR7-36
22"	559	48"	1219	227	102.9	4	7"	178	left swing door	SSC-HDDL7-48
22"	559	48"	1219	227	102.9	4	7"	178	right swing door	SSC-HDDR7-48

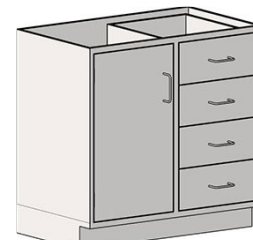

SSC-HDDL7-36

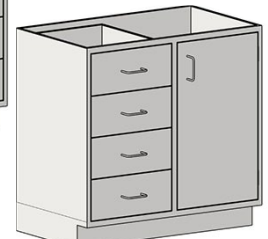

SSC-HDDR7-36

Units with Five 7" (178mm) Drawers

depth		width		weight		no. of drawers	drawer height		description	model #
in	mm	in	mm	lbs.	kg		in.	mm		
22"	559	30"	762	244	110.7	5	7"	178	left swing door	SSC-HDDL7D-30
22"	559	30"	762	244	110.7	5	7"	178	right swing door	SSC-HDDR7D-30
22"	559	36"	914	253	114.8	5	7"	178	left swing door	SSC-HDDL7D-36
22"	559	36"	914	253	114.8	5	7"	178	right swing door	SSC-HDDR7D-36
22"	559	48"	1219	269	122.0	5	7"	178	left swing door	SSC-HDDL7D-48
22"	559	48"	1219	269	122.0	5	7"	178	right swing door	SSC-HDDR7D-48

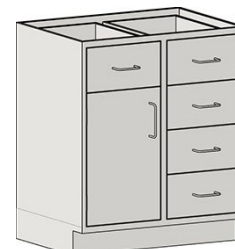

SSC-HDDL7D-30



Base Units - Standing Height Cabinets

Sink Bases

FEATURES:

- Units with hinged door(s).
- Standing Height - 35" (889mm) high.
- Partial height back panel.
- 22" (559mm) depth.

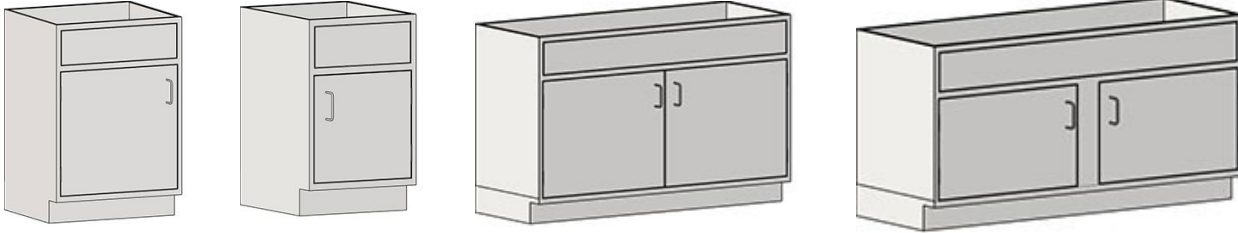

depth		width		weight		description	model #
in	mm	in	mm	lbs.	kg		
22"	559	18"	457	99	44.9	left swing door	SSC-HSBL-18
22"	559	18"	457	99	44.9	right swing door	SSC-HSBR-18
22"	559	24"	610	124	56.2	left swing door	SSC-HSBL-24
22"	559	24"	610	124	56.2	right swing door	SSC-HSBR-24
22"	559	30"	762	174	78.9	double doors	SSC-HSB-30
22"	559	36"	914	183	83.0	double doors	SSC-HSB-36
22"	559	48"	1219	199	90.2	double doors	SSC-HSB-48
22"	559	56"	1422	219	99.3	double doors	SSC-HSB-56
22"	559	58"	1473	222	100.7	double doors	SSC-HSB-58



Angled Sink Bases

FEATURES:

- Removable access panel at front
- Open design at rear for plumbing
- Mounts to adjacent freestanding base units

depth		width		weight		model #
in	mm	in	mm	lbs.	kg	
22"	559	24"	610	53	24.0	SSC-HSBA-24
22"	559	30"	762	56	25.4	SSC-HSBA-30
22"	559	36"	914	62	28.2	SSC-HSBA-36
22"	559	48"	1219	75	34.0	SSC-HSBA-48

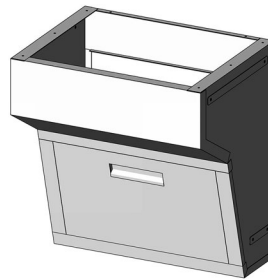

SSC-HSBS-36



Corner Base Cabinets

FEATURES:

- Standing Height - 35" (889mm) high.
- Intermediate shelf adjustable on 1/2" (12mm) increments!
- 22" (559mm) depth.

depth		width*		weight		description	model #
in	mm	in	mm	lbs.	kg		
22"	559	49"	1245	142	64.4	open base	SSC-HCOB-18
22"	559	49"	1245	149	67.6	left swing door	SSC-HCCBL-18
22"	559	49"	1245	149	67.6	right swing door	SSC-HCCBR-18

* Overall end-to-end dimension.

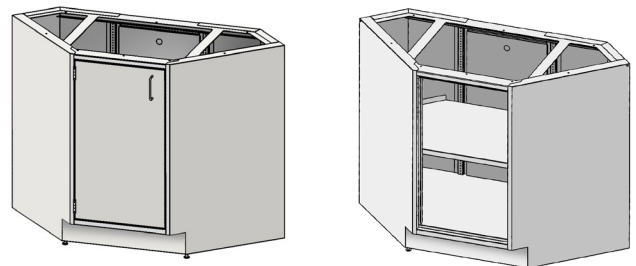

Base Units - Sitting Height Cabinets

with Open Base

depth		width		weight		description	model #
in	mm	in	mm	lbs.	kg		
22"	559	18"	457	72	32.7	open base	SSC-SOB-18
22"	914	24"	610	97	44.0	open base	SSC-SOB-24
22"	914	30"	610	122	55.3	open base	SSC-SOB-30
22"	914	36"	610	131	59.4	open base	SSC-SOB-36
22"	914	48"	610	147	66.7	open base	SSC-SOB-48

FEATURES:

- Open Base with interior shelf
- Sitting Height - 29½" (740mm) high.
- 22" (559mm) depth.

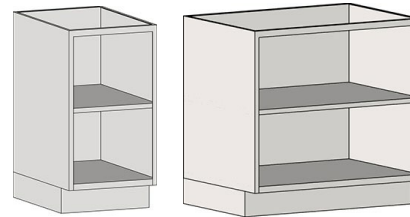

with Full Height Door(s)

depth		width		weight		description	model #
in	mm	in	mm	lbs.	kg		
22"	559	18"	457	97	44.0	left swing door	SSC-SCBL-18
22"	914	18"	457	97	44.0	right swing door	SSC-SCBR-18
22"	914	24"	610	122	55.3	left swing door	SSC-SCBL-24
22"	914	24"	610	122	55.3	right swing door	SSC-SCBR-24
22"	914	30"	762	172	78.0	double doors	SSC-SCB-30
22"	914	36"	914	181	82.1	double doors	SSC-SCB-36
22"	914	48"	1219	197	89.4	double doors	SSC-SCB-48

FEATURES:

- Full height door with interior shelf
- Sitting Height - 29½" (740mm) high.
- 22" (559mm) depth.

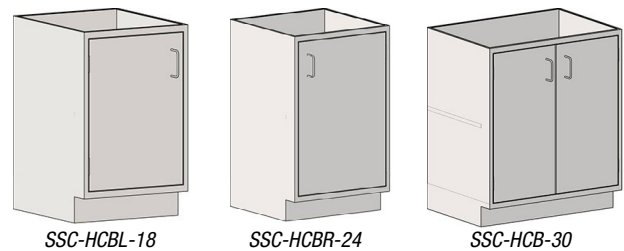

with Drawers

FEATURES:

- Units with single-bank full-length drawers.
- Sitting Height - 29½" (740mm) high.
- 22" (559mm) depth.

Two 12" (305mm) Drawers Per Unit

depth		width		weight		no. of drawers	drawer height		model #
in	mm	in	mm	lbs.	kg		in.	mm	
22"	559	18"	457	112	50.8	2	12"	305	SSC-SDB12-18
22"	559	24"	610	137	62.1	2	12"	305	SSC-SDB12-24

Four 6" (152mm) Drawers Per Unit

depth		width		weight		no. of drawers	drawer height		model #
in	mm	in	mm	lbs.	kg		in.	mm	
22"	559	18"	457	132	59.9	4	6"	152	SSC-SDB6-18
22"	559	24"	610	157	71.2	4	6"	152	SSC-SDB6-24

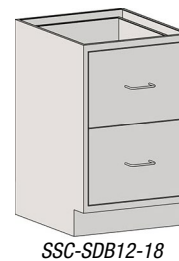

Base Units - Sitting Height Cabinets

with Door/Drawer Combination

FEATURES:

- Units with door(s) and drawer(s).
- Sitting Height - 29½" (740mm) high.
- 22" (559mm) depth.

Units with 3" (76mm) Drawers

depth		width		weight		no. of drawers	drawer height		description	model #
in	mm	in	mm	lbs.	kg		in.	mm		
22"	559	18"	457	117	53.1	2	3"	152	left swing door	SSC-SDDL3-18
22"	559	18"	457	117	53.1	2	3"	152	right swing door	SSC-SDDRT3-18
22"	559	24"	610	142	64.4	2	3"	152	left swing door	SSC-SDDL3-24
22"	559	24"	610	142	64.4	2	3"	152	right swing door	SSC-SDDRT3-24



SSC-SDDL3-24



SSC-SDDRT3-24

Units with 6" (152mm) Drawer

depth		width		weight		no. of drawers	drawer height		description	model #
in	mm	in	mm	lbs.	kg		in.	mm		
22"	559	18"	457	112	50.8	1	6"	152	left swing door	SSC-SDDL6-18
22"	914	18"	457	112	50.8	1	6"	152	right swing door	SSC-SDDRT6-18
22"	914	24"	457	137	62.1	1	6"	152	left swing door	SSC-SDDL6-24
22"	914	24"	610	137	62.1	1	6"	152	right swing door	SSC-SDDRT6-24

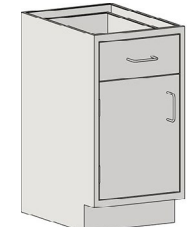

SSC-SDDL6-18



SSC-SDDRT6-18

Sink Bases



FEATURES:

- Units with hinged door(s).
- Sitting Height - 29½" (740mm) high.
- Partial height back panel.
- 22" (559mm) depth.

depth		width		weight		description	model #
in	mm	in	mm	lbs.	kg		
22"	559	18"	457	97	44.0	left swing door	SSC-SSBL-18
22"	914	18"	457	97	44.0	right swing door	SSC-SSBR-18
22"	914	24"	610	122	55.3	left swing door	SSC-SSBL-24
22"	914	24"	610	122	55.3	right swing door	SSC-SSBR-24
22"	914	30"	762	172	78.0	double doors	SSC-SSB-30
22"	914	36"	914	181	82.1	double doors	SSC-SSB-36
22"	914	48"	1219	197	89.4	double doors	SSC-SSB-48
22"	559	56	1422	217	98.4	double doors	SSC-SSB-56
22"	559	58	1473	220	99.8	double doors	SSC-SSB-58



SSC-SSBL-24

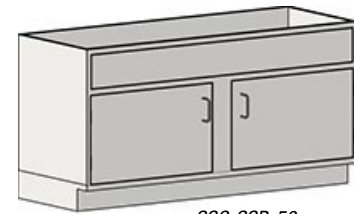

SSC-SSB-56

Angled Sink Bases

FEATURES:

- Removable access panel at front
- Open design at rear for plumbing
- Mounts to adjacent freestanding base units

depth		width		weight		model #
in	mm	in	mm	lbs.	kg	
22"	559	24"	610	49	22.2	SSC-SSBA-24
22"	559	30"	762	52	23.6	SSC-SSBA-30
22"	559	36"	914	56	25.4	SSC-SSBA-36
22"	559	48"	1219	65	29.5	SSC-SSBA-48

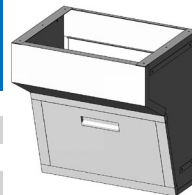

SSC-SSBA-18

FEATURES:

- Sitting Height - 29½" (740mm) high.
- Intermediate shelf adjustable on 1/2" (12mm) increments.
- 22" (559mm) depth.

Corner Base Cabinets



* Overall end-to-end dimension.

depth		width*		weight		description	model #
in	mm	in	mm	lbs.	kg		
22"	559	49"	1245	142	64.4	open base	SSC-SCOB-18
22"	559	49"	1245	149	67.6	left swing door	SSC-SCCBL-18
22"	559	49"	1245	149	67.6	right swing door	SSC-SCCBL-18

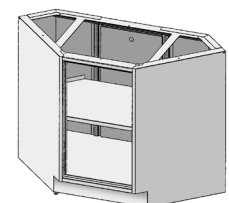
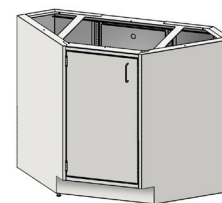

Base Fillers

Knee Space Apron Kits

depth		width		weight		without Drawer		w/One 3" Drawer	
in	mm	in.	mm	lbs.	kg	model #	weight	weight	model #
							lbs.	kg	
22"	559	24"	610	32	14.5	SSC-KAK-24	46	20.8	SSC-KAK1D-24
22"	559	30"	762	35	15.9	SSC-KAK-30	49	22.2	SSC-KAK1D-30
22"	559	36"	914	38	17.2	SSC-KAK-36	52	23.6	SSC-KAK1D-36
22"	559	48"	1219	41	18.5	SSC-KAK-48	55	25.0	SSC-KAK1D-48

FEATURES:

- Ships knocked down.
- Mounts to adjacent freestanding bases.
- Kits with Drawer feature 3" drawer assembly with wire pull.

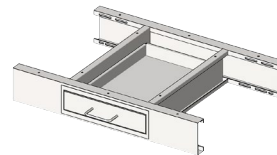

Knee-Space Filler Panels

width		weight		35" Standing Height		29 1/2" Sitting Height	
in	mm	lbs.	kg	model #	weight	weight	model #
					lbs.	kg	
24"	610	20.0	9.1	SSC-HKPL-24	17.0	7.7	SSC-SKPL-24
30"	762	22.0	10.1	SSC-HKPL-30	18.5	8.6	SSC-SKPL-30
36"	914	24.0	10.9	SSC-HKPL-36	20.0	9.0	SSC-SKPL-36

FEATURES:

- 29 1/2" (740mm) Sitting or 35" (889mm) Standing Height.
- For use with no apron above.



Toe Fillers

depth		width		weight		35" Standing Height		29 1/2" Sitting Height		84" Tall Height	
in	mm	in.	mm	lbs.	kg	model #	weight	weight	weight	model #	
							lbs.	kg	lbs.	kg	
1"	25	3"	76	1.0	0.5	SSC-HTF-3	0.9	0.5	SSC-STF-3	2.4	1.1
1"	25	6"	152	2.0	0.9	SSC-HTF-6	1.7	0.8	SSC-STF-6	4.8	2.2
1"	25	12"	305	3.0	1.4	SSC-HTF-12	2.5	1.1	SSC-STF-12	9.6	4.4

FEATURES:

- 29 1/2" (740mm) Sitting, 35" (889mm) Standing Height, or 84" (2134mm) Tall Height.



Toe Scribes

depth		width		weight		35" Standing Height		29 1/2" Sitting Height		84" Tall Height		
in	mm	in.	mm	orientation	lbs.	kg	model #	weight	weight	weight	model #	
								lbs.	kg	lbs.	kg	
1"	25	1"	25	left	1.0	0.5	SSC-HTSL-1	0.9	0.5	SSC-STSL-1	2.4	1.1
1"	25	2"	51	left	1.5	0.7	SSC-HTSL-2	1.0	0.5	SSC-STSL-2	3.6	1.6
1"	25	3"	76	left	2.0	0.9	SSC-HTSL-3	1.3	0.6	SSC-STSL-3	4.8	2.2
1"	25	1"	25	right	1.0	0.5	SSC-HTSR-1	0.9	0.5	SSC-STSR-1	2.4	1.1
1"	25	2"	51	right	1.5	0.7	SSC-HTSR-2	1.0	0.5	SSC-STSR-2	3.6	1.6
1"	25	3"	76	right	2.0	0.9	SSC-HTSR-3	1.3	0.6	SSC-STSR-3	4.8	2.2

FEATURES:

- 29 1/2" (740mm) Sitting, 35" (889mm) Standing Height, or 84" (2134mm) Tall Height.



Base Fillers

Rear Filler Panels

FEATURES:

- 29½" (740mm) Sitting, 35" (889mm) Standing Height, or 84" (2134mm) Tall Height.

depth		width		35" Standing Height			29½" Sitting Height			weight		
in	mm	in.	mm	lbs.	kg	model #	lbs.	kg	model #	lbs.	kg	model #
3"	76	6"	152	4.0	1.8	SSC-HRFP-6	3.0	1.4	SSC-SRFP-6	9.6	4.4	SSC-TRFP-6
3"	76	12"	305	5.0	2.3	SSC-HRFP-12	4.0	1.8	SSC-SRFP-12	14.4	6.5	SSC-TRFP-12



Rear Filler Scribes

FEATURES:

- 29½" (740mm) Sitting, 35" (889mm) Standing Height, or 84" (2134mm) Tall Height.

depth		width		35" Standing Height			29½" Sitting Height			84" Tall Height			
in	mm	in.	mm	orientation	lbs.	kg	model #	lbs.	kg	model #	lbs.	kg	model #
1"	25	1"	25	left	1.2	0.5	SSC-HRFSL-1	1.0	0.5	SSC-SRFSL-1	2.9	1.3	SSC-TRFSL-1
1"	25	2"	51	left	1.4	0.6	SSC-HRFSL-2	1.0	0.5	SSC-SRFSL-2	3.4	1.5	SSC-TRFSL-2
1"	25	3"	76	left	2.2	1.0	SSC-HRFSL-3	2.0	0.9	SSC-SRFSL-3	5.3	2.4	SSC-TRFSL-3
1"	25	6"	152	left	3.3	1.5	SSC-HRFSL-6	3.0	1.4	SSC-SRFSL-6	7.9	3.6	SSC-TRFSL-6
1"	25	1"	25	right	1.2	0.5	SSC-HRFSR-1	1.0	0.5	SSC-SRFSR-1	2.9	1.3	SSC-TRFSR-1
1"	25	2"	51	right	1.4	0.6	SSC-HRFSR-2	1.0	0.5	SSC-SRFSR-2	3.4	1.5	SSC-TRFSR-2
1"	25	3"	76	right	2.2	1.0	SSC-HRFSR-3	2.0	0.9	SSC-SRFSR-3	5.3	2.4	SSC-TRFSR-3
1"	25	6"	152	right	3.3	1.5	SSC-HRFSR-6	3.0	1.4	SSC-SRFSR-6	7.9	3.6	SSC-TRFSR-6



Corner Fillers

FEATURES:

- 29½" (740mm) Sitting, 35" (889mm) Standing Height, or 84" (2134mm) Tall Height.

depth		width		35" Standing Height			29½" Sitting Height			84" Tall Height		
in	mm	in.	mm	lbs.	kg	model #	lbs.	kg	model #	lbs.	kg	model #
1"	25	3"	76	2.0	0.9	SSC-HCF-3	1.5	0.7	SSC-SCF-3	4.8	2.2	SSC-TCF-3
1"	25	6"	152	3.0	1.4	SSC-HCF-6	2.5	1.1	SSC-SCF-6	7.2	3.3	SSC-TCF-6

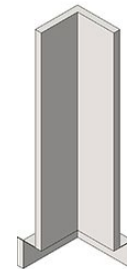

Upper Cabinets

Open Wall Cases

depth		width		weight		with Flat Top		with Sloped Top	
in	mm	in	mm	lbs.	kg	model #	weight	weight	model #
							lbs.	kg	
13"	330	18"	457	117	53.1	SSC-WCO-1318	132	59.9	SSC-WCOST-1318
13	330	24	610	123	55.8	SSC-WCO-1324	138	62.6	SSC-WCOST-1324
13	330	30	762	129	58.5	SSC-WCO-1330	144	65.3	SSC-WCOST-1330
13	330	36	914	141	63.9	SSC-WCO-1336	156	70.7	SSC-WCOST-1336
13	330	48	1219	165	74.8	SSC-WCO-1348	180	81.6	SSC-WCOST-1348
16	406	18	457	122	55.3	SSC-WCO-1618	137	62.1	SSC-WCOST-1618
16	406	24	610	128	58.0	SSC-WCO-1624	143	64.9	SSC-WCOST-1624
16	406	30	762	134	60.8	SSC-WCO-1630	149	67.6	SSC-WCOST-1630
16	406	36	914	146	66.2	SSC-WCO-1636	161	73.0	SSC-WCOST-1636
16	406	48	1219	170	77.1	SSC-WCO-1648	185	83.9	SSC-WCOST-1648

FEATURES:

- Open front.
- Two adjustable shelves.
- 31" (787mm) height.
- 13" (330mm) or 16" (406mm) depth.

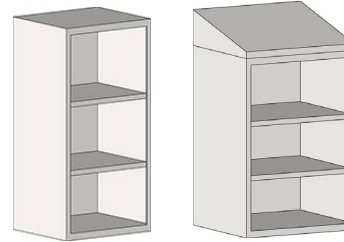

Solid Swinging Wall Cases

with Flat Top

depth		width		weight		description	model #
in	mm	in	mm	lbs.	kg		
13"	330	18"	457	136	61.7	left swing door	SSC-WCHL-1318
13"	330	18"	457	136	61.7	right swing door	SSC-WCHR-1318
13"	330	24"	610	142	64.4	left swing door	SSC-WCHL-1324
13"	330	24"	610	142	64.4	right swing door	SSC-WCHR-1324
13"	330	30"	762	154	69.8	double doors	SSC-WCH-1330
13"	330	36"	914	172	78.0	double doors	SSC-WCH-1336
13"	330	48"	1219	208	94.3	double doors	SSC-WCH-1348
16"	406	18"	457	142	64.4	left swing door	SSC-WCHL-1618
16"	406	18"	457	142	64.4	right swing door	SSC-WCHR-1618
16"	406	24"	610	148	67.1	left swing door	SSC-WCHL-1624
16"	406	24"	610	148	67.1	right swing door	SSC-WCHR-1624
16"	406	30"	762	160	72.6	double doors	SSC-WCH-1630
16"	406	36"	914	166	75.3	double doors	SSC-WCH-1636
16"	406	48"	1219	214	97.1	double doors	SSC-WCH-1648

FEATURES:

- Full height solid hinged door(s).
- Two adjustable shelves.
- 31" (787mm) height.
- 13" (330mm) or 16" (406mm) depth.

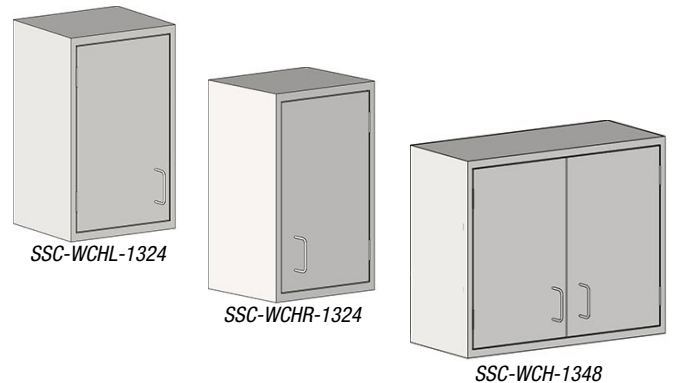

with Sloped Top

depth		width		weight		description	model #
in	mm	in	mm	lbs.	kg		
13"	330	18"	457	156	70.7	left swing door	SSC-WCHLST-1318
13"	330	18"	457	156	70.7	right swing door	SSC-WCHRST-1318
13"	330	24"	610	162	73.5	left swing door	SSC-WCHLST-1324
13"	330	24"	610	162	73.5	right swing door	SSC-WCHRST-1324
13"	330	30"	762	174	78.9	double doors	SSC-WCHST-1330
13"	330	36"	914	192	87.1	double doors	SSC-WCHST-1336
13"	330	48"	1219	228	103.4	double doors	SSC-WCHST-1348
16"	406	18"	457	162	73.5	left swing door	SSC-WCHLST-1618
16"	406	18"	457	162	73.5	right swing door	SSC-WCHRST-1618
16"	406	24"	610	168	76.2	left swing door	SSC-WCHLST-1624
16"	406	24"	610	168	76.2	right swing door	SSC-WCHRST-1624
16"	406	30"	762	180	81.6	double doors	SSC-WCHST-1630
16"	406	36"	914	186	84.4	double doors	SSC-WCHST-1636
16"	406	48"	1219	234	106.1	double doors	SSC-WCHST-1648

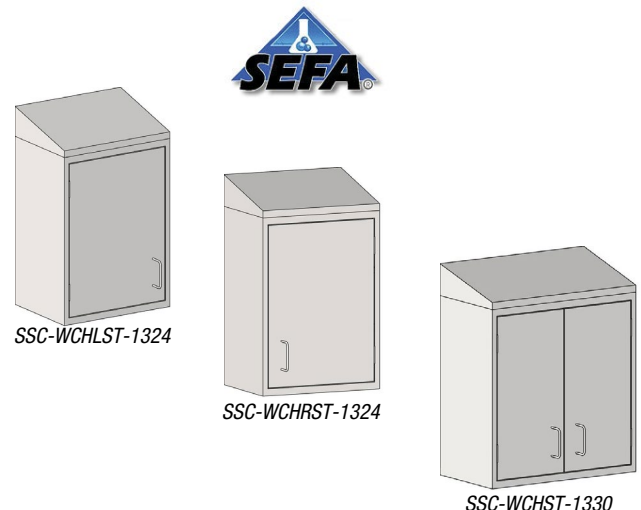

Upper Cabinets

Framed Glass Swinging Wall Cases

- Full height hinged door(s) with framed glass.
- Two adjustable shelves.
- 31" (787mm) height.
- 13" (330mm) or 16" (406mm) depth.

FEATURES:

with Flat Top

depth		width		weight		description	model #
in	mm	in	mm	lbs.	kg		
13"	330	18"	457	166	75.3	left swing door	SSC-WCGHL-1318
13"	330	18"	457	166	75.3	right swing door	SSC-WCGHR-1318
13"	330	24"	610	172	78.0	left swing door	SSC-WCGHL-1324
13"	330	24"	610	172	78.0	right swing door	SSC-WCGHR-1324
13"	330	30"	762	184	83.4	double doors	SSC-WCGH-1330
13"	330	36"	914	184	83.4	double doors	SSC-WCGH-1336
13"	330	48"	1219	202	91.6	double doors	SSC-WCGH-1348
16"	406	18"	457	172	78.0	left swing door	SSC-WCGHL-1618
16"	406	18"	457	172	78.0	right swing door	SSC-WCGHR-1618
16"	406	24"	610	178	80.7	left swing door	SSC-WCGHL-1624
16"	406	24"	610	178	80.7	right swing door	SSC-WCGHR-1624
16"	406	30"	762	160	72.6	double doors	SSC-WCGH-1630
16"	406	36"	914	166	75.3	double doors	SSC-WCGH-1636
16"	406	48"	1219	214	97.1	double doors	SSC-WCGH-1648

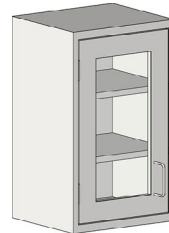

SSC-WCGHL-1324

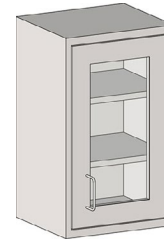

SSC-WCGHR-1324

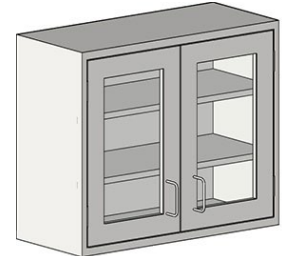

SSC-WCGH-1348



with Sloped Top

depth		width		weight		description	model #
in	mm	in	mm	lbs.	kg		
13"	330	18"	457	186	84.4	left swing door	SSC-WCGHLST-1318
13"	330	18"	457	186	84.4	right swing door	SSC-WCGHRST-1318
13"	330	24"	610	192	87.1	left swing door	SSC-WCGHLST-1324
13"	330	24"	610	192	87.1	right swing door	SSC-WCGHRST-1324
13"	330	30"	762	244	110.7	double doors	SSC-WCGHST-1330
13"	330	36"	914	222	100.7	double doors	SSC-WCGHST-1336
13"	330	48"	1219	158	71.7	double doors	SSC-WCGHST-1348
16"	406	18"	457	192	87.1	left swing door	SSC-WCGHLST-1618
16"	406	18"	457	192	87.1	right swing door	SSC-WCGHRST-1618
16"	406	24"	610	198	89.8	left swing door	SSC-WCGHLST-1624
16"	406	24"	610	198	89.8	right swing door	SSC-WCGHRST-1624
16"	406	30"	762	210	95.2	double doors	SSC-WCGHST-1630
16"	406	36"	914	216	98.0	double doors	SSC-WCGHST-1636
16"	406	48"	1219	264	119.7	double doors	SSC-WCGHST-1648

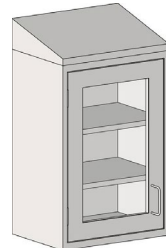

SSC-WCGHLST-1324

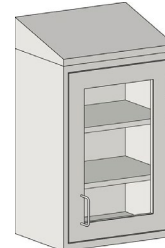

SSC-WCGHRST-1324

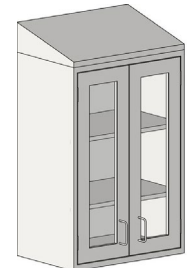

SSC-WCGHST-1630

Corner Cases



depth		width*		weight		description	model #
in	mm	in	mm	lbs.	kg		
13"	330	36 1/2"	924	120	54.4	open front	SSC-WCCO-1318
13"	330	18"	457	126	57.2	left swing door	SSC-WCCHL-1318
13"	330	18"	457	126	57.2	right swing door	SSC-WCCHR-1318
16"	406	18"	457	135	61.2	open front	SSC-WCCO-1618
16"	406	18"	457	141	64.0	left swing door	SSC-WCCHL-1618
16"	406	18"	457	141	64.0	right swing door	SSC-WCCHR-1618

* Overall end-to-end dimension.

- Open front or solid hinged left or right door.
- Two adjustable shelves.
- 31" (787mm) height.
- 13" (330mm) or 16" (406mm) depth.

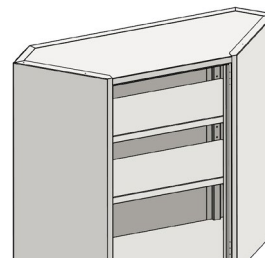

SSC-WCCHR-1318

Tall Cabinets

Open Tall Cases

depth		width		weight		with Flat Top		with Sloped Top	
in	mm	in	mm	lbs.	kg	model #	weight	weight	model #
							lbs.	kg	
18"	457	24"	610	263	119.3	SSC-TOB-1824	283	128.3	SSC-TOBST-1824
18"	457	30"	762	293	132.9	SSC-TOB-1830	313	142.0	SSC-TOBST-1830
18"	457	36"	914	301	136.5	SSC-TOB-1836	321	145.6	SSC-TOBST-1836
18"	457	48"	1219	331	150.1	SSC-TOB-1848	351	159.2	SSC-TOBST-1848
24"	610	24"	610	338	153.3	SSC-TOB-2424	358	162.4	SSC-TOBST-2424
24"	610	30"	762	368	166.9	SSC-TOB-2430	388	176.0	SSC-TOBST-2430
24"	610	36"	914	413	187.3	SSC-TOB-2436	433	196.4	SSC-TOBST-2436
24"	610	48"	1219	443	200.9	SSC-TOB-2448	463	210.0	SSC-TOBST-2448



FEATURES:

- Open front.
- Five adjustable shelves.
- 84" (2134mm) height.
- 18" (457mm) or 24" (610mm) depth.

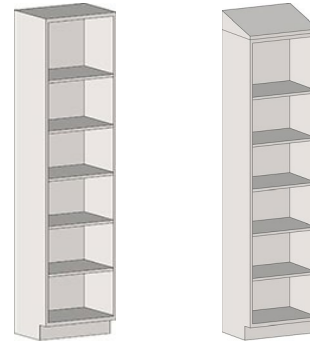

Solid Swinging Tall Cases

with Flat Top

depth		width		weight		description	model #
in	mm	in	mm	lbs.	kg		
18"	457	24"	610	343	64.4	left swing door	SSC-TCBL-1824
18"	457	24"	610	343	64.4	right swing door	SSC-TCBR-1824
18"	457	30"	762	381	69.8	double doors	SSC-TCB-1830
18"	457	36"	914	413	78.0	double doors	SSC-TCB-1836
18"	457	48"	1219	418	94.3	double doors	SSC-TCB-1848
24"	610	24"	610	373	67.1	left swing door	SSC-TCBL-2424
24"	610	24"	610	373	67.1	right swing door	SSC-TCBR-2424
24"	610	30"	762	448	72.6	double doors	SSC-TCB-2430
24"	610	36"	914	493	75.3	double doors	SSC-TCB-2436
24"	610	48"	1219	523	97.1	double doors	SSC-TCB-2448

FEATURES:

- Full height solid hinged door(s).
- Five adjustable shelves.
- 84" (2134mm) height.
- 18" (457mm) or 24" (610mm) depth.

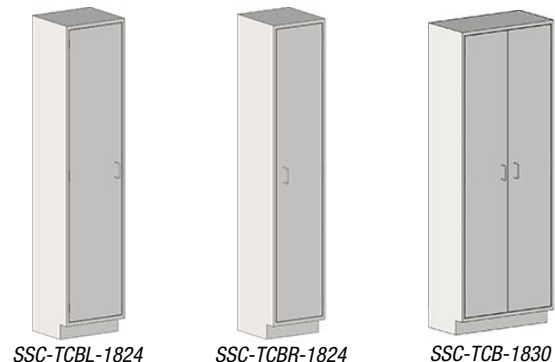

with Sloped Top

depth		width		weight		description	model #
in	mm	in	mm	lbs.	kg		
18"	457	24"	610	363	164.6	left swing door	SSC-TCBSTL-1824
18"	457	24"	610	363	164.6	right swing door	SSC-TCBSTR-1824
18"	457	30"	762	401	181.9	double doors	SSC-TCBST-1830
18"	457	36"	914	431	195.5	double doors	SSC-TCBST-1836
18"	457	48"	1219	438	198.6	double doors	SSC-TCBST-1848
24"	610	24"	610	393	178.2	left swing door	SSC-TCBSTL-2424
24"	610	24"	610	393	178.2	right swing door	SSC-TCBSTR-2424
24"	610	30"	762	468	212.2	double doors	SSC-TCBST-2430
24"	610	36"	914	513	232.7	double doors	SSC-TCBST-2436
24"	610	48"	1219	543	246.3	double doors	SSC-TCBST-2448

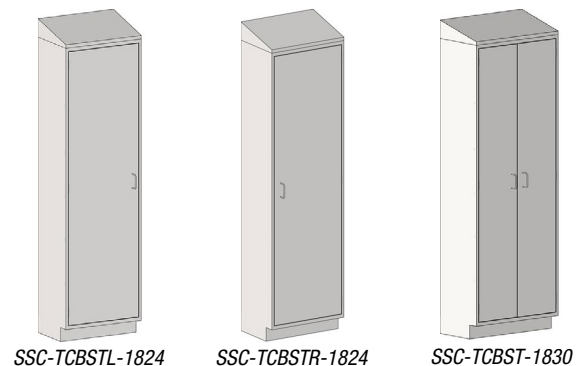

Tall Cabinets



Framed Glass Swinging Tall Cases

- Full height hinged door(s) with framed glass.
- Five adjustable shelves.
- 84" (2134mm) height.
- 18" (457mm) or 24" (610mm) depth.

FEATURES:

with Flat Top

depth		width		weight		description	model #
in	mm	in	mm	lbs.	kg		
18"	457	24"	610	443	200.9	left swing door	SSC-TCBGL-1824
18"	457	24"	610	443	200.9	right swing door	SSC-TCBGR-1824
18"	457	30"	762	481	218.1	double doors	SSC-TCBG-1830
18"	457	36"	914	481	218.1	double doors	SSC-TCBG-1836
18"	457	48"	1219	518	234.9	double doors	SSC-TCBG-1848
24"	610	24"	610	473	214.5	left swing door	SSC-TCBGL-2424
24"	610	24"	610	473	214.5	right swing door	SSC-TCBGR-2424
24"	610	30"	762	548	248.5	double doors	SSC-TCBG-2430
24"	610	36"	914	593	268.9	double doors	SSC-TCBG-2436
24"	610	48"	1219	623	282.5	double doors	SSC-TCBG-2448

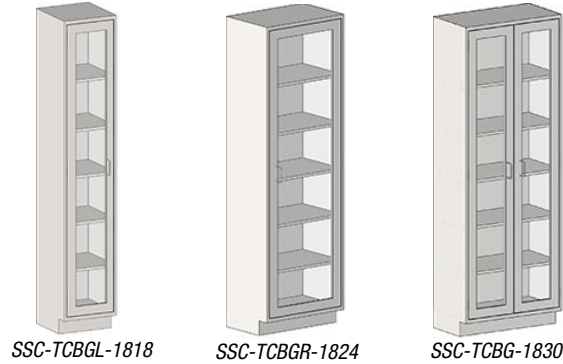

with Sloped Top

depth		width		weight		description	model #
in	mm	in	mm	lbs.	kg		
18"	457	24"	610	463	210.0	left swing door	SSC-TCBGLST-1824
18"	457	24"	610	463	210.0	right swing door	SSC-TCBGRST-1824
18"	457	30"	762	501	227.2	double doors	SSC-TCBGST-1830
18"	457	36"	914	531	240.8	double doors	SSC-TCBGST-1836
18"	457	48"	1219	538	244.0	double doors	SSC-TCBGST-1848
24"	610	24"	610	493	223.6	left swing door	SSC-TCBGLST-2424
24"	610	24"	610	493	223.6	right swing door	SSC-TCBGRST-2424
24"	610	30"	762	568	257.6	double doors	SSC-TCBGST-2430
24"	610	36"	914	613	278.0	double doors	SSC-TCBGST-2436
24"	610	48"	1219	643	291.6	double doors	SSC-TCBGST-2448

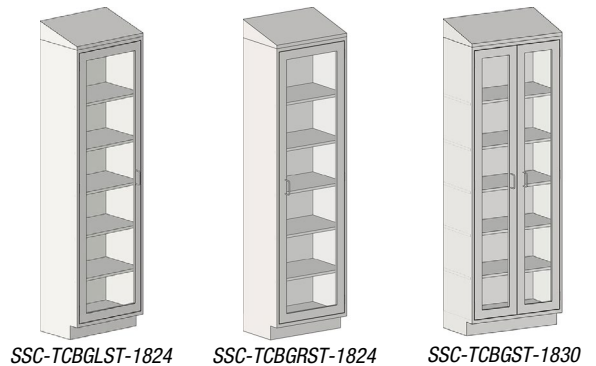

Peg Boards



SSC-PB1824-4



- Heavy gauge 304 stainless steel construction
- Comes standard with 6" white polymer pegs
- Choice of 2" or 4" integral drip trough
- All drip troughs come with 36" long clear flexible drain tubing
- Wall mounting bracket included

FEATURES:

width		height		weight		no. of pegs	2" drip trough	4" drip trough
in	mm	in	mm	lbs.	kg		model #	model #
18"	457	24"	610	13	5.9	15	SSC-PB1824-2	SSC-PB1824-4
24"	610	18"	457	15	6.8	16	SSC-PB2418-2	SSC-PB2418-4
24"	610	24"	610	17	7.7	20	SSC-PB2424-2	SSC-PB2424-4
24"	610	30"	762	23	10.4	32	SSC-PB2430-2	SSC-PB2430-4
24"	610	36"	914	25	11.8	40	SSC-PB2436-2	SSC-PB2436-4
30"	762	24"	610	23	10.4	25	SSC-PB3024-2	SSC-PB3024-4
30"	762	30"	762	25	10.9	50	SSC-PB3030-2	SSC-PB3030-4
30"	762	36"	914	25	10.9	40	SSC-PB3036-2	SSC-PB3036-4
36"	914	24"	610	25	11.8	30	SSC-PB3624-2	SSC-PB3624-4
36"	914	30"	762	26	10.9	60	SSC-PB3630-2	SSC-PB3630-4
36"	914	36"	914	27	11.3	66	SSC-PB3636-2	SSC-PB3636-4
48"	1219	24"	610	26	11.8	40	SSC-PB3624-2	SSC-PB3624-4
48"	1219	30"	762	28	12.7	48	SSC-PB3630-2	SSC-PB3630-4
48"	1219	36"	914	30	13.6	88	SSC-PB3636-2	SSC-PB3636-4

Laboratory Wall Shelves



FEATURES:

- 16 gauge stainless steel shelves, with center hat channel and 1 1/4" rear upturn
- Adjustable on 1/2" increments
- 36" tall, 1" square tubular uprights

**WITH
UPTURNED
BOOKENDS**

**WITH
DOWNTURNED
BOOKENDS**

shelf depth		shelf length		overall length		weight		STANDARD SHELVES	WITH WIRE LEDGE	STANDARD SHELVES	WITH WIRE LEDGE
in	mm	in	mm	in	mm	lbs.	kg	model #	model #	model #	model #
12"	305	30"	762	31"	787	38	17.2	LS1230-36-3	LS1230-36-3L	LSD1230-36-3	LSD1230-36-3L
12"	305	36"	914	37"	939	43	19.5	LS1236-36-3	LS1236-36-3L	LSD1236-36-3	LSD1236-36-3L
12"	305	48"	1219	49"	1244	52	23.6	LS1248-36-3	LS1248-36-3L	LSD1248-36-3	LSD1248-36-3L
12"	305	60"	1524	61"	1549	62	28.1	LS1260-36-3	LS1260-36-3L	LSD1260-36-3	LSD1260-36-3L
12"	305	72"	1828	73"	1854	71	32.2	LS1272-36-3	LS1272-36-3L	LSD1272-36-3	LSD1272-36-3L
15"	381	30"	762	31"	787	44	20.0	LS1530-36-3	LS1530-36-3L	LSD1530-36-3	LSD1530-36-3L
15"	381	36"	914	37"	939	50	22.7	LS1536-36-3	LS1536-36-3L	LSD1536-36-3	LSD1536-36-3L
15"	381	48"	1219	49"	1244	61	27.7	LS1548-36-3	LS1548-36-3L	LSD1548-36-3	LSD1548-36-3L
15"	381	60"	1524	61"	1549	72	32.7	LS1560-36-3	LS1560-36-3L	LSD1560-36-3	LSD1560-36-3L
15"	381	72"	1828	73"	1854	83	37.6	LS1572-36-3	LS1572-36-3L	LSD1572-36-3	LSD1572-36-3L
18"	457	30"	762	31"	787	51	23.1	LS1830-36-3	LS1830-36-3L	LSD1830-36-3	LSD1830-36-3L
18"	457	36"	914	37"	939	57	25.9	LS1836-36-3	LS1836-36-3L	LSD1836-36-3	LSD1836-36-3L
18"	457	48"	1219	49"	1244	70	31.8	LS1848-36-3	LS1848-36-3L	LSD1848-36-3	LSD1848-36-3L
18"	457	60"	1524	61"	1549	83	37.5	LS1860-36-3	LS1860-36-3L	LSD1860-36-3	LSD1860-36-3L
18"	457	72"	1828	73"	1854	97	44.0	LS1872-36-3	LS1872-36-3L	LSD1872-36-3	LSD1872-36-3L



Vertical Storage Cabinets



vertical storage cabinet with flat top

FEATURES:

- Type 304 stainless steel construction.
- Four (4) adjustable intermediate shelves.
- Hinged doors with wire-style pulls.
- Stationary “-SLG” units feature stainless steel legs with 1” (25mm) adjustable bullet feet.
- Mobile “-CPB” units include 4” (102mm)-diameter swivel/brake casters with poly tread.

Note: Custom sizes, glass doors, locks, and additional shelves available upon request. Please contact Factory for pricing on these options.



			with Flat Top				with Sloped Top							
depth		width	stationary	height		weight		model #	height		weight		model #	
in	mm	in.		mm	lbs.	kg	in.		mm	lbs.	kg			
18"	457	36"	914	stationary	72"	1829	416	188.7	SSC-TSC-1836	77"	1956	419	190.0	SSC-TSCST-1836
18"	457	48"	1219	stationary	72"	1829	490	222.3	SSC-TSC-1848	77"	1956	495	224.5	SSC-TSCST-1848
24"	610	36"	914	stationary	72"	1829	458	207.7	SSC-TSC-2436	77"	1956	461	209.1	SSC-TSCST-2436
24"	610	48"	1219	stationary	72"	1829	539	244.5	SSC-TSC-2448	77"	1956	545	247.2	SSC-TSCST-2448
24"	610	36"	914	mobile	72"	1829	462	209.6	SSC-TSC-2436-CPB	78"	1981	465	210.9	SSC-TSCST-2436-CPB
24"	610	48"	1219	mobile	72"	1829	543	246.3	SSC-TSC-2448-CPB	78"	1981	549	249.0	SSC-TSCST-2448-CPB

Bench Frames

Consult Factory for pricing.

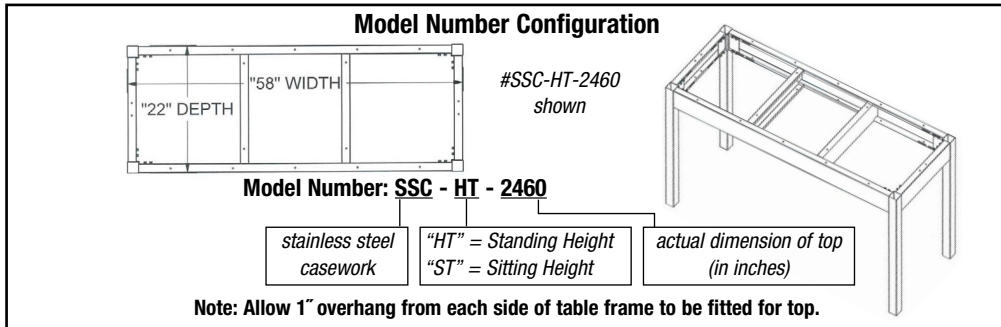

Standard Bench Frames

- FEATURES:**
- Standing and Sitting-Height models available.
 - 22" (559mm) or 28" (712mm) depth.

depth		width		weight		35" Standing Height		29 1/2" Sitting Height	
in	mm	in	mm	lbs.	kg	weight	model #	weight	model #
				lbs.	kg	lbs.	kg	lbs.	kg
22"	559	22"	559	50	22.7	48	21.8	53	24.0
22"	559	28"	711	55	24.9	53	24.0	58	26.3
22"	559	34"	864	60	27.2	58	26.3	63	28.6
22"	559	40"	1016	65	29.5	63	28.6	68	30.8
22"	559	46"	1168	70	31.7	68	30.8	76	34.5
22"	559	58"	1473	78	35.4	76	34.5	82	37.2
22"	559	64"	1626	84	38.1	82	37.2	88	39.9
22"	559	70"	1778	90	40.8	88	39.9		
28"	711	22"	559	55	24.9	53	24.0	58	26.3
28"	711	28"	711	58	26.3	56	25.4	63	28.6
28"	711	34"	864	65	29.5	63	28.6	68	30.8
28"	711	40"	1016	70	31.7	68	30.8	73	33.1
28"	711	46"	1168	75	34.0	73	33.1	82	37.2
28"	711	58"	1473	84	38.1	82	37.2	89	40.4
28"	711	64"	1626	91	41.3	89	40.4		
28"	711	70"	1778	98	44.4	96	43.5		

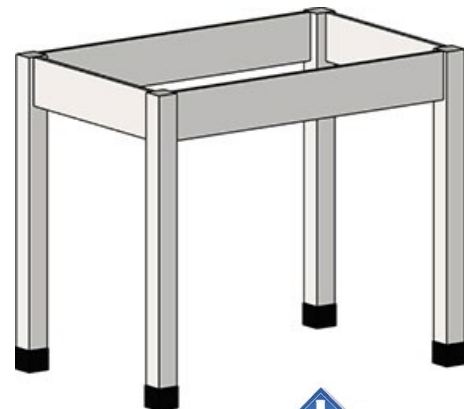

Bench Frames

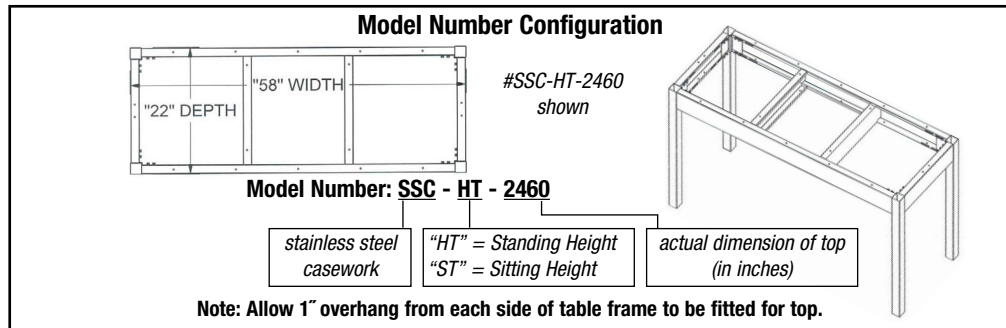

with One Drawer

depth		width		35"		29 $\frac{1}{8}$ "		weight		model #	
				Standing Height		Sitting Height					
in	mm	in	mm	lbs.	kg	lbs.	kg	lbs.	kg	lbs.	kg
22"	559	22"	559	50	22.7	SSC-HT1D-2424	48	21.8	SSC-ST1D-2424	48	21.8
22"	559	28"	711	55	24.9	SSC-HT1D-2430	53	24.0	SSC-ST1D-2430	53	24.0
22"	559	34"	864	60	27.2	SSC-HT1D-2436	58	26.3	SSC-ST1D-2436	58	26.3
22"	559	40"	1016	65	29.5	SSC-HT1D-2442	63	28.6	SSC-ST1D-2442	63	28.6
22"	559	46"	1168	70	31.7	SSC-HT1D-2448	68	30.8	SSC-ST1D-2448	68	30.8
22"	559	58"	1473	78	35.4	SSC-HT1D-2460	76	34.5	SSC-ST1D-2460	76	34.5
22"	559	64"	1626	84	38.1	SSC-HT1D-2466	82	37.2	SSC-ST1D-2466	82	37.2
22"	559	70"	1778	90	40.8	SSC-HT1D-2472	88	39.9	SSC-ST1D-2472	88	39.9
28"	711	22"	559	55	24.9	SSC-HT1D-3024	53	24.0	SSC-ST1D-3024	53	24.0
28"	711	28"	711	58	26.3	SSC-HT1D-3030	56	25.4	SSC-ST1D-3030	56	25.4
28"	711	34"	864	65	29.5	SSC-HT1D-3036	63	28.6	SSC-ST1D-3036	63	28.6
28"	711	40"	1016	70	31.7	SSC-HT1D-3042	68	30.8	SSC-ST1D-3042	68	30.8
28"	711	46"	1168	75	34.0	SSC-HT1D-3048	73	33.1	SSC-ST1D-3048	73	33.1
28"	711	58"	1473	84	38.1	SSC-HT1D-3060	82	37.2	SSC-ST1D-3060	82	37.2
28"	711	64"	1626	91	41.3	SSC-HT1D-3066	89	40.4	SSC-ST1D-3066	89	40.4
28"	711	70"	1778	98	44.4	SSC-HT1D-3072	96	43.5	SSC-ST1D-3072	96	43.5

FEATURES:

- Standing and Sitting-Height models available.
- 22" (559mm) or 28" (712mm) depth.

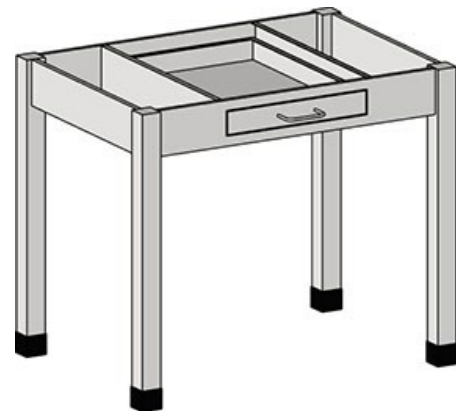

with Two Drawers

depth		width		35"		29 $\frac{1}{8}$ "		weight		model #	
				Standing Height		Sitting Height					
in	mm	in	mm	lbs.	kg	lbs.	kg	lbs.	kg	lbs.	kg
22"	559	22"	559	50	22.7	SSC-HT2D-2424	48	21.8	SSC-ST2D-2424	48	21.8
22"	559	28"	711	55	24.9	SSC-HT2D-2430	53	24.0	SSC-ST2D-2430	53	24.0
22"	559	34"	864	60	27.2	SSC-HT2D-2436	58	26.3	SSC-ST2D-2436	58	26.3
22"	559	40"	1016	65	29.5	SSC-HT2D-2442	63	28.6	SSC-ST2D-2442	63	28.6
22"	559	46"	1168	70	31.7	SSC-HT2D-2448	68	30.8	SSC-ST2D-2448	68	30.8
22"	559	58"	1473	78	35.4	SSC-HT2D-2460	76	34.5	SSC-ST2D-2460	76	34.5
22"	559	64"	1626	84	38.1	SSC-HT2D-2466	82	37.2	SSC-ST2D-2466	82	37.2
22"	559	70"	1778	90	40.8	SSC-HT2D-2472	88	39.9	SSC-ST2D-2472	88	39.9
28"	711	22"	559	55	24.9	SSC-HT2D-3024	53	24.0	SSC-ST2D-3024	53	24.0
28"	711	28"	711	58	26.3	SSC-HT2D-3030	56	25.4	SSC-ST2D-3030	56	25.4
28"	711	34"	864	65	29.5	SSC-HT2D-3036	63	28.6	SSC-ST2D-3036	63	28.6
28"	711	40"	1016	70	31.7	SSC-HT2D-3042	68	30.8	SSC-ST2D-3042	68	30.8
28"	711	46"	1168	75	34.0	SSC-HT2D-3048	73	33.1	SSC-ST2D-3048	73	33.1
28"	711	58"	1473	84	38.1	SSC-HT2D-3060	82	37.2	SSC-ST2D-3060	82	37.2
28"	711	64"	1626	91	41.3	SSC-HT2D-3066	89	40.4	SSC-ST2D-3066	89	40.4
28"	711	70"	1778	98	44.4	SSC-HT2D-3072	96	43.5	SSC-ST2D-3072	96	43.5

FEATURES:

- Standing and Sitting-Height models available.
- 22" (559mm) or 28" (712mm) depth.

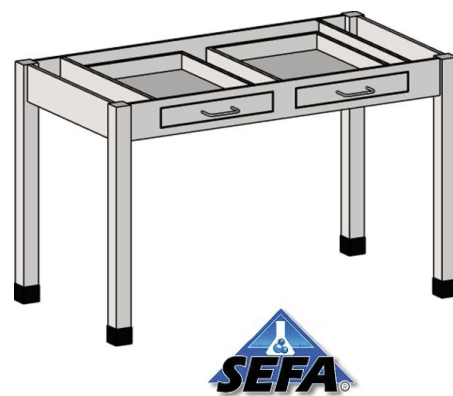

Adjustable Height Tables

Pinned Leg Adjustable Height Tables



depth*		width*		model #	model #
in	mm	in	mm		
22"	559	22"	559	SSC-AHTP-2424	SSC-AHTTP-2424
22"	559	28"	711	SSC-AHTP-2430	SSC-AHTTP-2430
22"	559	34"	864	SSC-AHTP-2436	SSC-AHTTP-2436
22"	559	46"	1168	SSC-AHTP-2448	SSC-AHTTP-2448
22"	559	58"	1473	SSC-AHTP-2460	SSC-AHTTP-2460
22"	559	70"	1778	SSC-AHTP-2472	SSC-AHTTP-2472
28"	711	28"	711	SSC-AHTP-3030	SSC-AHTTP-3030
28"	711	34"	864	SSC-AHTP-3036	SSC-AHTTP-3036
28"	711	46"	1168	SSC-AHTP-3048	SSC-AHTTP-3048
28"	711	58"	1473	SSC-AHTP-3060	SSC-AHTTP-3060
28"	711	70"	1778	SSC-AHTP-3072	SSC-AHTTP-3072

* For units with tabletop, add 2" to width and depth. Tabletop is 16 gauge stainless steel, with support channels, sound-deadening tape, and square edge on all for sides.

FEATURES:

- 2" (51mm) square legs with leveling mount.
- Adjustable from 30" to 37" (762 to 940mm) height.
- 22" (559mm) or 28" (712mm) depth.



Electronic Drive Adjustable Height Tables

depth*		width*		model #	model #
in	mm	in	mm		
22"	559	22"	559	SSC-AHTM-2424	SSC-AHTTM-2424
22"	559	28"	711	SSC-AHTM-2430	SSC-AHTTM-2430
22"	559	34"	864	SSC-AHTM-2436	SSC-AHTTM-2436
22"	559	46"	1168	SSC-AHTM-2448	SSC-AHTTM-2448
22"	559	58"	1473	SSC-AHTM-2460	SSC-AHTTM-2460
22"	559	70"	1778	SSC-AHTM-2472	SSC-AHTTM-2472
28"	711	28"	711	SSC-AHTM-3030	SSC-AHTTM-3030
28"	711	34"	864	SSC-AHTM-3036	SSC-AHTTM-3036
28"	711	46"	1168	SSC-AHTM-3048	SSC-AHTTM-3048
28"	711	58"	1473	SSC-AHTM-3060	SSC-AHTTM-3060
28"	711	70"	1778	SSC-AHTM-3072	SSC-AHTTM-3072

* For units with tabletop, add 2" to width and depth. Tabletop is 16 gauge stainless steel, with support channels, sound-deadening tape, and square edge on all for sides.

- 2" (51mm) square legs with leveling mount.
- 29" to 40" (737 to 1016mm) height adjustment.
- Electromechanical drive in each leg.
- 22" (559mm) or 28" (712mm) depth.



Healthcare Storage Cabinets



double-width unit with baskets



FEATURES:

- Type 304 stainless steel construction.
- 45 pairs of slides on inner panels.
- Hinged doors, with 4" (102mm) wire-style pulls, available solid or with framed glass.
- Single- and double-width units available.
- 83" (2108mm) height.



single-width unit with baskets

Single-Width Units

Double-Width Units

depth			width			width		
in	mm	description	in.	mm	model #	in.	mm	model #
18"	457	solid	28"	711	PSSC-TCB-1828	54"	1372	PSSC-TCB-1854
18"	457	with framed glass	28"	711	PSSC-TCBG-1828	54"	1372	PSSC-TCBG-1854
26"	661	solid	20"	508	PSSC-TCB-2620	38"	965	PSSC-TCB-2638
26"	661	with framed glass	20"	508	PSSC-TCBG-2620	38"	965	PSSC-TCBG-2638



Baskets and Trays for Healthcare Storage Cabinets

FEATURES:

- Cream-colored ABS material.
- Tray stopper keeps basket / tray from falling.
- 23 3/8" x 15 3/4" (600 x 400mm).



#PSSC-SB4

Baskets and Trays

height				length x width				OPEN BASKETS	SOLID TRAYS	SHORT	LONG
in.	mm	in.	mm	in.	mm	in.	mm	model #	model #	model #	model #
2"	51	23 3/8"	15 3/4"	600	400	-	-	PSSC-ST2	PSSC-SD2	PSSC-LD2	
4"	102	23 3/8"	15 3/4"	600	400	PSSC-SB4	PSSC-ST4	PSSC-SD4	PSSC-LD4		
8"	203	23 3/8"	15 3/4"	600	400	PSSC-SB8	PSSC-ST8	PSSC-SD8	PSSC-LD		

Optional Dividers



#PSSC-ST8 shown with dividers

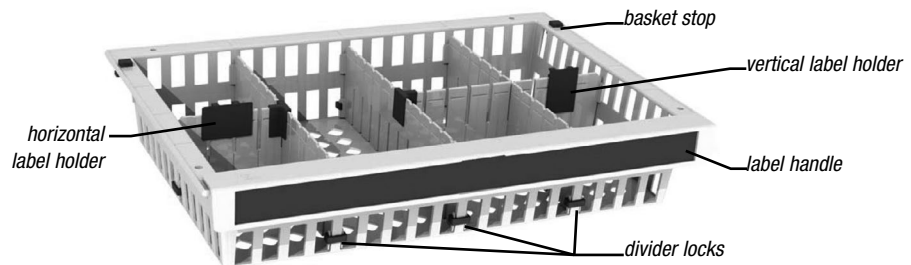

Download Spec Sheet EG03.71

Accessories for Baskets and Trays

description	model #
vertical label holder: can be adhered to top of dividers or front edge of baskets	PSSC-LHV
horizontal label holder: can be adhered to top of dividers or front edge of baskets	PSSC-LHH
label handle: color-coded, over 20 colors available	PSSC-LHAN
T-holder for dividers: allows use of custom-length dividers	PSSC-THD
basket stop: prevents basket from falling out when pulled	PSSC-BSKSTP
divider lock: keeps dividers locked in place	PSSC-DL



Stainless Steel Countertops



stainless steel countertops fabricated to drawings indicating backsplash height, raised edge and field condition requirements

- 14 or 16 gauge, type 304 or 316 stainless steel. Other gauges and types of stainless available to meet the function and chemical resistant demands of highly specialized labs.
- Standard front edge Square or Box Marine, unless otherwise specified. See *detail 1* on next page.
- Back and end splashes are manufactured per specification. See *details 2 & 3* on next page. All working surfaces and sink bowls have coved sanitary horizontal and vertical corners.
- Either a mechanical hairline seam or field welded joint available per your specifications. Maximum length without seam is 144" if no end splash. Length is reduced by 5½" for each end splash that may be required.
- Fabricated sink bowls available in most any size and depth with single or multiple compartments.
- For backsplash mounted faucets, splash will need to be at least 2" deep for plumbing access, holes for deck mounted faucets are typically centered 1½" from the edge of sink bowl.
- Both L-shaped and U-shaped tops are available per your drawings.
 - Corners are mitered and factory welded.
 - Maximum size without field joint provisions is 96" x 96" to fit into standard trailer for ground shipment.
- Countertops have stainless steel reinforcing hat channels. National Sanitation Foundation (NSF)-listed sprayed latex sound deadening available upon request.
- Standard packaging is wood crated and is included in the cost.



Stainless Steel Countertops

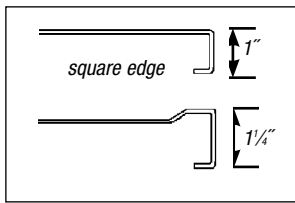
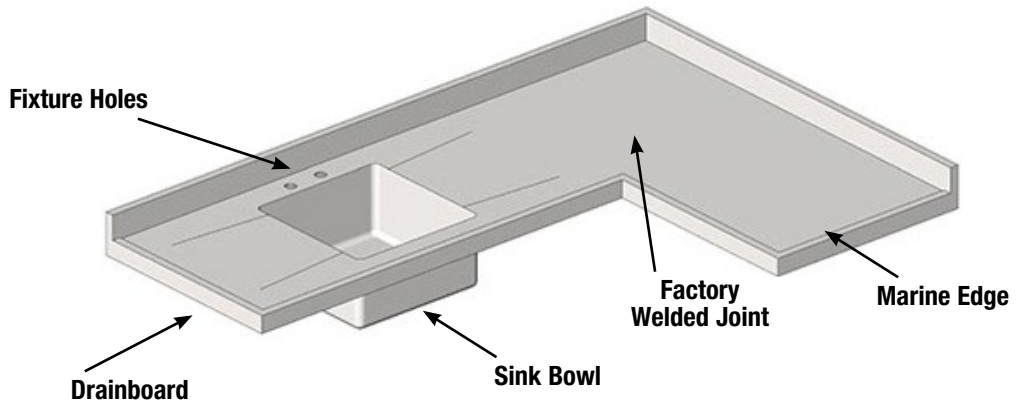
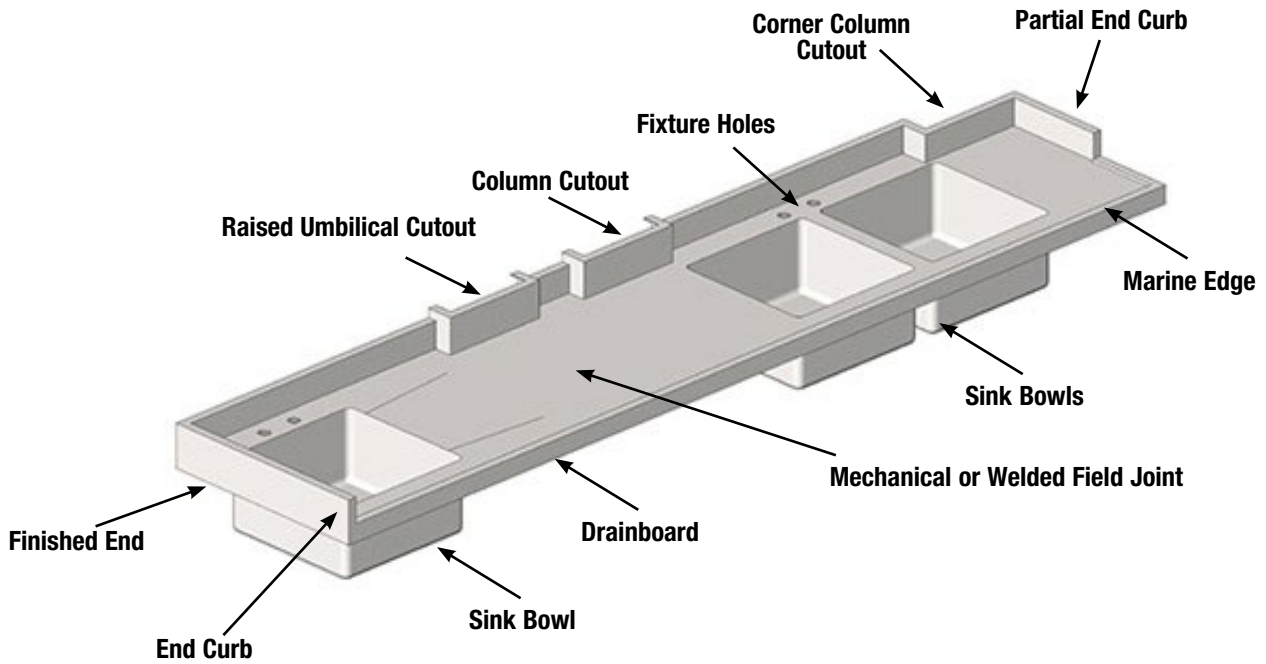

detail 1: edges

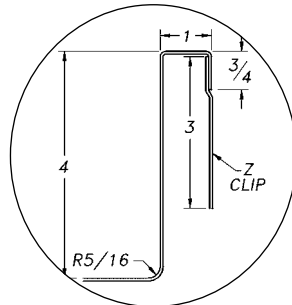

detail 2:
4" backsplash with 1" return and turndown.
Z-clip provided for wall attachment.

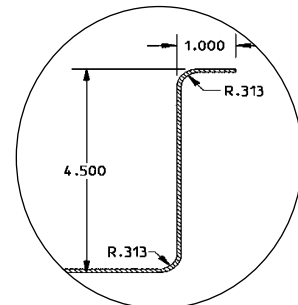

detail 3:
4-1/2" backsplash with 1" return.

- NOTE:**
- Drawings to be submitted for approval prior to fabrication using the latest version of AutoCad software. They will be emailed in Adobe Acrobat format (.pdf) unless specified otherwise. AutoCad files (.dwg) are available upon request.
 - Complete field welding and finishing services are available at additional expense.