

Operation and Maintenance Manual

Electronic Laboratory Autoclaves Models 2840 EL-D

EL-D: standard autoclave

C: optional system for fast cooling

PV: optional vacuum pump

BH: optional bio hazard filtration

F: optional fan for super-fast cooling



Cat. No. MAN205-00450003EN Rev. J

☒ Heidolph North America , 1241 Jarvis Ave. Elk Grove Village IL, ☎ Phone: 224-265-9600 ☒ Fax: 224-265-9611, e-mail: sales@heidolph.com

☒ Brinkmann Instruments (Canada) Ltd. 4160 Sladeview Crescent #6, Mississauga, Ontario L5N 2L8, ☎ (905) 569-0664, Toll Free: (866) 260-6069, ☒ Fax: (905) 569-0665

Table Of Contents

Paragraph	page no.
1	General 4
1.1	Incoming Inspection 4
1.2	Warranty 4
1.3	Warranty Statement 4
1.4	Ordering Information 5
1.5	Accessories..... 6
2	Safety Instructions..... 7
3	Technical Data 9
3.1	Introduction 9
3.2	Storage Conditions.....10
3.3	Operating Conditions10
3.4	Directives and Standards11
3.5	Electrical Data.....11
3.6	Water Quality12
3.7	Specifications.....13
3.8	Overall Dimensions: 2840EL-D13
3.9	Overall Dimensions: 2840ELPV-D.....15
3.10	Utilities15
3.11	Construction.....16
3.12	Environment Emission Information16
3.13	Safety Features.....16
3.14	Stickers Description17
3.15	Front View: EL2840, ELPV284018
3.16	Rear View: EL 284019
3.17	Rear View: ELPV 2840.....20
4	Control Panel21
4.1	Control Panel Drawing21
4.2	Description and Functions of the Front Panel Keyboard22
4.3	Displayed Error Messages / Symbols24
4.4	Displayed operational messages / Symbols24
5	Sterilization Programs26
5.1	Program 1: Glass29
5.2	Program 2: Plastic.....30
5.3	Program 3: Liquid A31
5.4	Program 4: Liquid B – Waste.....32
5.5	Program 5: Liquid A – Cooling (C – cooling models only).....33
5.6	Program 6: Liquid B – Waste Cooling (C – cooling models only)34
5.7	Program 7: Bio Hazard 1 (BH, bio-hazard models only)35
5.8	Program 8: Bio Hazard 2 (BH, bio-hazard models only)36

5.9	Program 9: Bio Hazard Liquids (BH, bio-hazard models only)	37
5.10	Program 10: Vacuum Test (PV, pre-vacuum models only)	38
5.11	Program 11: Warm-Up	39
5.12	Program 12: Isothermal	40
5.13	Program 13: Air Mixture	41
5.14	Program 14: Glass Test	43
5.15	Program 15: Durham	44
6	Screens	46
6.1	Screens following a completely successful cycle – "Cycle Ended"	46
6.2	Screens following aborted cycles after complete sterilization stage	47
6.3	Screens following a fail cycle:	47
7	Printer	49
7.1	Printer Output	49
7.2	Printer Handling	51
8	Installation	54
8.1	Placing	54
8.2	Lifting and carrying	55
8.3	Filling the Mineral-Free Water Reservoir	55
9	Preparation before Sterilization	58
9.1	Instruments	58
9.2	Wrapped Instruments	59
9.3	Packs	60
9.4	Tubing	61
9.5	Liquids	61
10	Operating Instructions	62
10.1	Turning on the autoclave	62
10.2	Opening the door	62
10.3	Loading	63
10.4	Operation	63
10.5	Unloading	64
10.6	Stopping the process and canceling the ERROR message	65
10.7	Cycle by Clock mode (Start Cycle by Clock)	65
11	Checking and Changing Parameters and Other Data	66
11.1	Browsing through the menus	66
11.2	Changing a Parameter	67
11.3	Quick options screen	69
11.4	Logging in and entering the Main menu	73
11.5	Changing parameters	74
11.6	System Parameters	75
11.7	Maintenance	76
11.8	Cycle parameters	77
12	Service and Maintenance Instructions	79
12.1	Preventive and Scheduled Maintenance	79
12.2	Draining the Reservoirs	81
12.3	Cleaning the Air Jet	82

12.4	Replacing the Door Gasket	83
12.5	Checking the Safety Valve	83
12.6	Cleaning the water outlet strainer	85
12.7	Cleaning the water sensor	86
13	Troubleshooting	88
14	Baskets and Containers	91
14.1	Pouch Rack ACS215-0008.....	91
15	Spare Parts List.....	92
16	Accessories.....	92

1 General



Read the Operating Instructions carefully, before beginning any operation on the autoclave!

1.1 Incoming Inspection

The autoclave should be unpacked and inspected for mechanical damage upon receipt. Observe packing method and retain packing materials until the unit has been inspected. Mechanical inspection involves checking for signs of physical damage such as: scratched panel surfaces, broken knobs, etc.

If damage is apparent, contact your dealer or point of purchase, so that they may notify the manufacturer and file a claim with the appropriate carrier.

All Tuttnauer products are carefully inspected prior to shipment and all reasonable precautions are taken in preparing them for shipment to assure safe arrival at their destination.

1.2 Warranty

We certify that this instrument is guaranteed to be free from defects in material and workmanship for one year against faulty components and assembly with the exception of glassware, lamps and heaters.

The warranty does not include and does not replace routine treatment and preventive maintenance to be performed according to instructions in sec. 12.1 (Preventive Maintenance).

Our obligation is limited to replacing the instrument or parts, after our examination, if within one year after the date of shipment they prove to be defective. This warranty does not apply to any instrument that has been subjected to misuse, neglect, accident or improper installation or application, nor shall it extend to products that have been repaired or altered outside the factory without prior authorization from us.

The Autoclave should not be used in a manner not described in this manual!

1.3 Warranty Statement

To activate your warranty or for warranty information on this unit please contact your dealer or Heidolph at one of the #'s listed below:

☒ Heidolph North America , 1241 Jarvis Ave. Elk Grove Village IL, ☎
Phone: 224-265-9600 ☐ Fax: 224-265-9611, e-mail:
sales@heidolph.com

☒ Brinkmann Instruments (Canada) Ltd. 4160 Sladeview Crescent #6,
Mississauga, Ontario L5N 2L8, ☎ (905) 569-0664, Toll Free: (866) 260-
6069, ☐ Fax: (905) 569-0665

Tuttnauer USA Co., Ltd., 25 Power Drive Hauppauge, NY 11788, USA
(800) 624 5836, (631) 737 4850, Fax: (631) 737 0720
e-mail:info@tuttnauerUSA.com.

Note:

If you have any questions or there are any difficulties with this instrument and the solution is not covered in this manual, please contact your dealer or Heidolph.

Do not attempt to service this instrument yourself.

If there is any difficulty with this instrument, and the solution is not covered in this manual, contact our representative or us first. Do not attempt to service this instrument yourself. Describe the difficulty as clearly as possible so we may be able to diagnose the problem and provide a prompt solution.

If the autoclave is equipped with a printer, send along a copy of the last printout for our inspection. If replacement parts are needed, stipulate the model and serial number of the machine.

No products will be accepted for repair without proper authorization from us. All transportation charges must be paid both ways by the owner. This warranty will be void if the unit is not purchased from an authorized full service **Tuttnauer** dealer.

1.4 Ordering Information

Several items must be specified when ordering the unit from your dealer.

- The chamber diameter and chamber depth required
- Please specify the supply voltage available (i.e. 115v/208v; 1Ph/3Ph)
- The temperature scale needed (Celsius or Fahrenheit).
- The pressure scale needed (kPa or psi)

1.5 Accessories

- Baskets – Different size baskets are available for these units. The baskets are made of stainless steel wire and have a handle. The basket allows the operator to load a large quantity of materials into the chamber.
The baskets are made of stainless steel wire and have a handle. The basket allows the operator to load a large quantity of materials into the chamber.
- Stainless steel containers - Different size containers are available for these units.
The containers are designed for sterilizing waste material. The containers have vent holes along the upper rim.

2 Safety Instructions

The autoclave has unique characteristics. Please read and understand the operation instructions before first operation of the autoclave. The following issues may require instructions guidance provided by the manufacturer: how to operate the autoclave, the door safety mechanism, the dangers involved in circumventing safety means, how to ensure that the door is closed, and how to select a correct sterilization program.

Make sure that you know where the main power switch is, where the water cut-off valve is and where the compressed air disconnection valve is located.

Autoclave maintenance is crucial for the correct and efficient function of the device. We enclose a log booklet that includes maintenance recommendations, with every device.

The weekly spore test is part of the preventive maintenance plan, along with the annual validation of the sterilization processes that ensures appropriate temperature dispersion within the chamber.

Never use the autoclave to sterilize corrosive products, such as: acids, bases and phenols, volatile compounds or solutions such ethanol, methanol or chloroform nor radioactive substances.

1. Never start using a new autoclave or a new steam generator, before the safety, licensing and authorization department has approved it for use.
2. All autoclave users must receive training in proper usage from an experienced employee. Every new employee must undergo a training period under an experienced employee.
3. A written procedure must be established for autoclave operation, including: daily safety tests, seal inspection and door hinge inspection, smooth action of the closing mechanism, chamber cleaning, prevention of clogging and preservation from corrosion, what is permitted and what is prohibited for sterilization and choosing a sterilization program.
4. Liquids may be sterilized only with the "liquids" program. The container must be covered but not sealed. Sealed bottles may only be sterilized using a special program. The bottle must be either Pyrex or a Borosilicate glass bottle.
5. When sterilizing plastic materials, make sure that the item can withstand sterilization temperature. Plastic that melts in the chamber is liable to cause a great deal of damage.
6. Individual glass bottles may be placed within an appropriate container that will be placed on a tray. Never place glass bottles on the floor of the autoclave. Never fill more than 2/3 of the bottle volume.
7. On closing the autoclave's door, make sure it is properly locked before activating.
8. Before withdrawing trays, wear heat resistant gloves.

9. Before opening the door, verify that there is no pressure in the chamber.
10. Open the door slowly to allow steam to escape and wait 5 minutes before you remove the load. When sterilizing liquids, wait 10 minutes.
11. Once a month, ensure that the safety valves are functioning, and once annually a certified tester must conduct pressure chamber safety tests.
12. Once annually, or more frequently, effective tests must be performed, i.e., calibration and validation.
13. Examine the condition of assemblies on a regular basis. Make sure there are no leaks, breaks, blockages, whistles or strange noises.
14. It is required to conduct maintenance operations as instructed.
15. Immediately notify the person in charge of any deviation or risk for the proper function of the device.

3 Technical Data

3.1 Introduction

Model 2840 EL-D/ELPV-D represent a table-top sterilizer designed especially for the sterilization of instruments, liquids, medical waste, and other materials in hospital laboratories, medical laboratories, research institutes, food laboratories and pharmaceutical facilities.

A computerized control unit ensuring a fully automatic sterilization cycle controls the autoclave.

The temperature and pressure are controlled through sensors placed inside and outside the media container or bottles.

Special feature of ELPV-D model is the vacuum pump that enables air removal prior to sterilization and during the drying stage.

The PV (pre-vacuum) models are equipped with a vacuum pump.

The advantages of the pre-vacuum sterilizer in comparison to the regular gravity displacement steam sterilizer are as follows:

- Removal of air pockets from packs and porous loads and most kinds of tubes (rubber, plastic etc.) by vacuum at the first stage of the cycle.
- Better steam penetration into the load; resulting in effective sterilization.
- Better temperature uniformity.
- Better drying of materials with closed doors due to the vacuum achieved in the chamber at the end of the sterilization cycle.

In BH (bio-hazard) models, a bio-hazard filter installed in the chamber enables sterilizing bio-hazard load without contaminating the surrounding.

There is a configuration equipped with fan that allows shortening the cooling operation.

The temperature and pressure are controlled through sensors placed inside and outside the media container or bottles.

The sterilizer is fully automatic with a choice of five programs (including the vacuum test program) eliminating any need for operator intervention during a cycle.

The sterilizer has multiple built - in safety devices, which provides adequate protection to ensure the safety of operating personnel.

On all models, a printer is an optional addition to the autoclave. The printer prints the preset and actual parameters of the cycle (temperature, time and pressure/vacuum).

The pressure scale, printer option can be set up at any time by a technician.

Note: After operating the sterilizer, brown stains might appear on the bottom of the chamber. These stains are a result of the heating elements that are located at the lower external part of the chamber. The brown color is a common phenomenon, can easily be removed, and will not have any effect on the sterilized goods.

This manual is intended to give the user a general understanding of how the autoclave works and indicates the best ways to operate and take care of it in order to obtain optimum results and a trouble-free operation. After reading this manual, operating the autoclave should be straightforward. However, since the autoclave is built using high technology sensitive components, no attempt should be made by the user or any other unauthorized person to repair or recalibrate it.



Only technical personnel having proper qualifications, holding technical documentation and adequate test instrumentation are authorized to undertake repair or service.

3.2 Storage Conditions

The packed or unpacked autoclave shall be retained in indoor conditions!

3.3 Operating Conditions

This device is for indoor use only!

The sterilizer should be loaded only with autoclavable material!

The environment shall not exceed an ambient temperature of 40°C and a relative humidity of 85% respectively.

The operation altitude shall not be over 2000 meters (6561 feet) (ambient pressure shall not be lower than 80 kPa (11.6 psi)).

The autoclave shall not be used in a manner not specified in this manual!

Do not use the autoclave in the presence of dangerous gases.

Operate the autoclave only in the manner specified in the manual. If the equipment is used in a manner not specified by the manufacturer, the protection provided by the equipment may be impaired.



Caution!

Waste water should be brought into the public net in accordance with the local rules or requirements i.e. ONLY NON-HAZARDOUS LIQUIDS SHALL BE DISPOSED IN PUBLIC SEWAGE!

3.4 Directives and Standards

Every autoclave meets the provisions of the following Directives and is constructed in compliance with the following Standards:

Tuttnauer. Ltd. company meets the provisions of the following standards:

EN ISO	13485:2012	(Quality Systems for Medical Devices)
ISO	9001:2008	(Quality Systems)
MDD	93/42/EEC	(Medical Device Directive)

Tuttnauer. Ltd. company also works in conjunction with and refers to:

AAMI/ANSI-ST8	Hospital sterilizers
ASME	American Society of Mechanical Engineers Section VIII, Division 1, for unfired pressure vessels
EN 13060	Small Steam Sterilizers
UL	UL 61010-1
PED	97/23EEC
IEC	IEC 61010-2-040 Safety
IEC	IEC 61326-1 EMC
ISO	17665-1:2006 (Validation and Routine Control)

3.5 Electrical Data

Specifications	Value
Total Power	2000W (2*1000W)
Voltage	230VAC / 1ph
Amperage	10A
Protection against electrical shock	Class I (IEC 60601-1)
Mains supply fluctuation	+/- 10%
Degree of protection by enclosure	IP31

Note: In order to avoid any injury by electrical hazard, it is recommended that a ground fault protection device be installed in the electrical panel feeding the autoclave (local codes may make this mandatory).

3.6 Water Quality

The distilled or mineral-free water supply shall be according to the table below:

Physical Characteristics and Maximum acceptable contaminants levels in water or steam, for steam generator and sterilizers

	Contaminants in water supplied to generator/chamber	Contaminants in condensate at steam inlet to sterilizer
Evaporate residue	≤ 10 mg/l	N/A
Silicate (SiO₂)	≤ 1 mg/l	≤ 0.1 mg/l
Iron	≤ 0.2mg/l	≤ 0.1mg/l
Cadmium	≤ 0.005 mg/l	≤ 0.005 mg/l
Lead	≤ 0.05 mg/l	≤ 0.05 mg/l
Rest of heavy metals except iron, cadmium, lead	≤ 0.1 mg/l	≤ 0.1 mg/l
Chloride (Cl)	≤ 2 mg/l	≤ 0.1 mg/l
Phosphate (P₂O₅)	≤ 0.5 mg/l	≤ 0.1 mg/l
Conductivity (at 25°C)	3 to 15 µs/cm	≤ 3 µs/cm
pH value (degree of acidity)	5 to 7.5	5 to 7
Hardness (Σ ions of alkaline earth)	≤ 0.02 mmol/l	≤ 0.02 mmol/l
Appearance	Colorless, clean, without sediments	

Compliance with the above data should be tested in accordance with acknowledged analytical methods, by an authorized laboratory.

Attention:

The use of water for autoclaves that do not comply with the table above may have severe impact on the working life of the sterilizer and can invalidate the manufacturer's guarantee.

Use only deionized water, having a maximum conductivity of 15 µs/cm. Conductivity greater than 15 µs/cm may cause failures.

Tap water supply

The range of hardness value 0.7-2.0 mmol/l (70- 200 mg/l CaCO₃)

The use of soft water is strictly forbidden!

Please consult a water specialist!

3.6.1 Reverse Osmosis

A Reverse Osmosis system may be used to improve the quality of the water used to generate steam in the autoclave chamber. The use of mineral free will contribute to better performance and longer life of the autoclave.

3.7 Specifications

Property		Value	
		EL	ELPV
Overall dimensions	Height	440mm	397mm
	Width	530mm	535mm
	Length	631mm	660mm
Maximum dimensions (door open)	Length	961	980mm
Distance between supporting legs	Width	315mm (front legs), 400mm (reat legs)	
	Length	415	452
Net weight		43kg	
Weight per support area (max. load)		According to overall weight and floor loading requirements	
Shipping volume		0.23 m3	
Shipping weight		51kg	
Shipping dimensions	length	720mm	
	width	620mm	
	height	510mm	
Max. Allowable Working pressure (MAWP)		2.8 bar	
Chamber	diameter	28mm	
	Depth	40mm	
Chamber Volume		28.5L	

3.8 Overall Dimensions: 2840EL-D

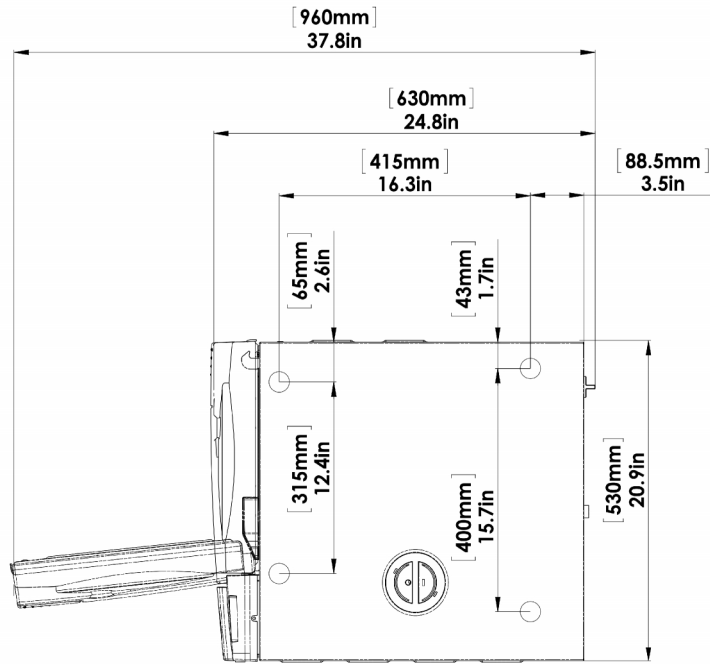
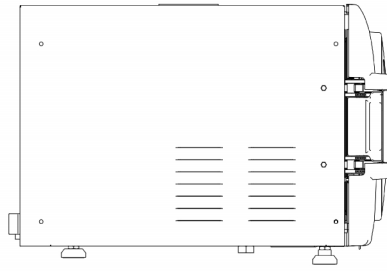
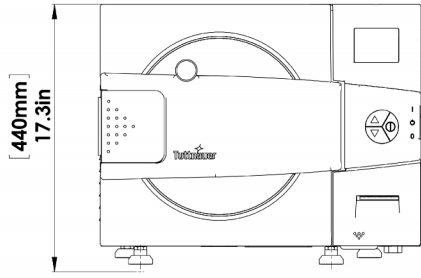

3.9 Overall Dimensions: 2840ELPV-D

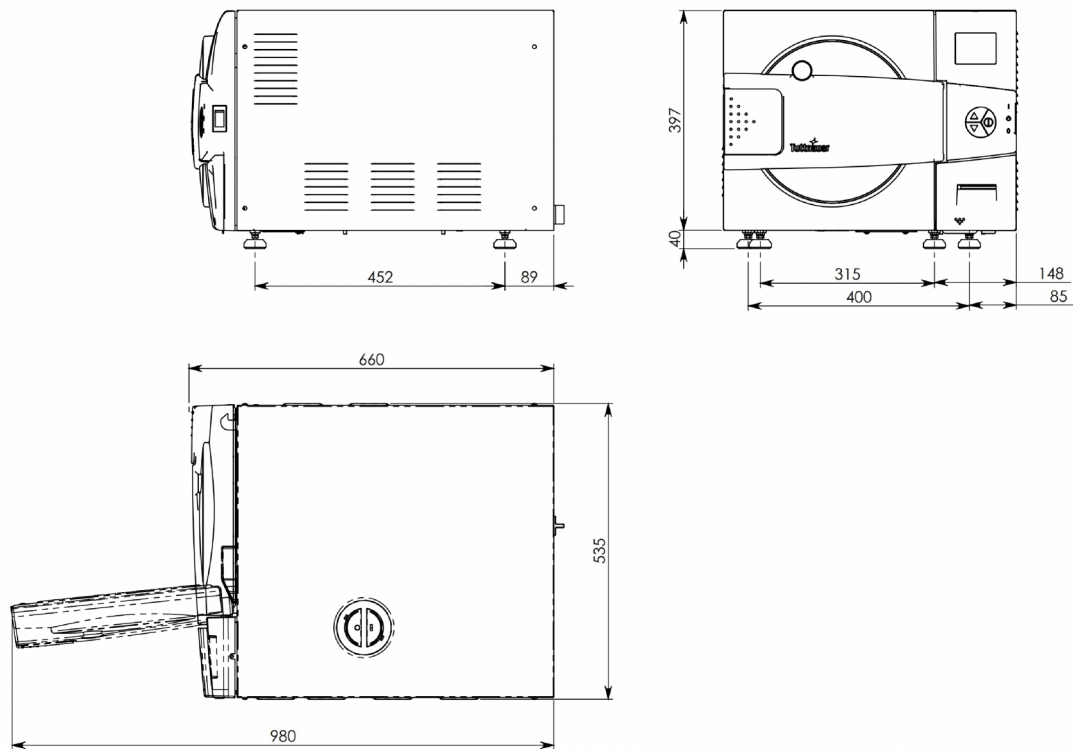

Note: In order to avoid any injury by electrical hazard, it is recommended that a ground fault protection device be installed in the electrical panel feeding the autoclave (local codes may make this mandatory).

3.10 Utilities

Property	Value
Compressed Air (C, cooling models only)	1/2" 3 Bar
Tap water	1/2", 2-6 Bar
Mineral free water	See table in sec.3.6.
Power supply	* 1 phase, 230VAC ±10%, 60Hz
Recommended circuit breaker	15A

* According to the local network.



Attention:

- **A switch or circuit-breaker must be included in the building installation. This switch or circuit-breaker shall be in close proximity to the equipment, within easy reach of the operator; and marked as the disconnecting device for the equipment.**
- **The electrical net must be protected with a current leakage safety relay.**
- **The electrical network must comply with local rules or regulations.**
- **Verify that there is an easy access to the main power switch, to the water cut-off valve and to the current leakage safety relay.**

3.11 Construction

The main parts of the autoclave are made of materials as indicated below:

- Chamber is built of stainless steel.
- Door is made of stainless steel.
- Trays are made of stainless steel.
- Water reservoir is made of hard plastic material.
- Door handle is made of hard plastic material, which is safe to touch and thermo-insulated.

3.12 Environment Emission Information







1. The peak sound level generated by the autoclave is 65dBa with background noise of 48 dBa.
2. The total heat per hour transmitted by the autoclave is <200Wh.

3.13 Safety Features

This autoclave includes built-in safety features such as:

- Error message display.
- Temperature dependent door locking system according to European standards.
- Electronic pressure and temperature measurement.
- Safety relief valve to avoid build-up of excessive pressure.
- Door switch enabling operation to be started only when the door is closed.
- Water level safety device.
- Excess temperature protection.

3.14 Stickers Description

Symbol	Meaning	Part Number	Location
	Caution! Hot steam.	LAB048-0058	Near the safety valve
	Protective earth (Ground)	LAB048-0020	Near the earthing screw
	Caution! Hot surface.	LAB048-0023	On the rear cover above the water strainer
	Press & Hold Until "System Ready" is Displayed = 10 sec.	LAB048-0461 (Automatic door only)	On the door right edge
	Don't Touch Microswitches please Contact Tuttnauer Service	LAB048-0462	On the door frame behind the door cover
	Don't Touch Microswitches please Contact Tuttnauer Service	LAB048-0463	On the door frame behind the door cover
	On-Off	LAB048-0018	Near the Power switch

3.15 Front View: EL2840, ELPV2840

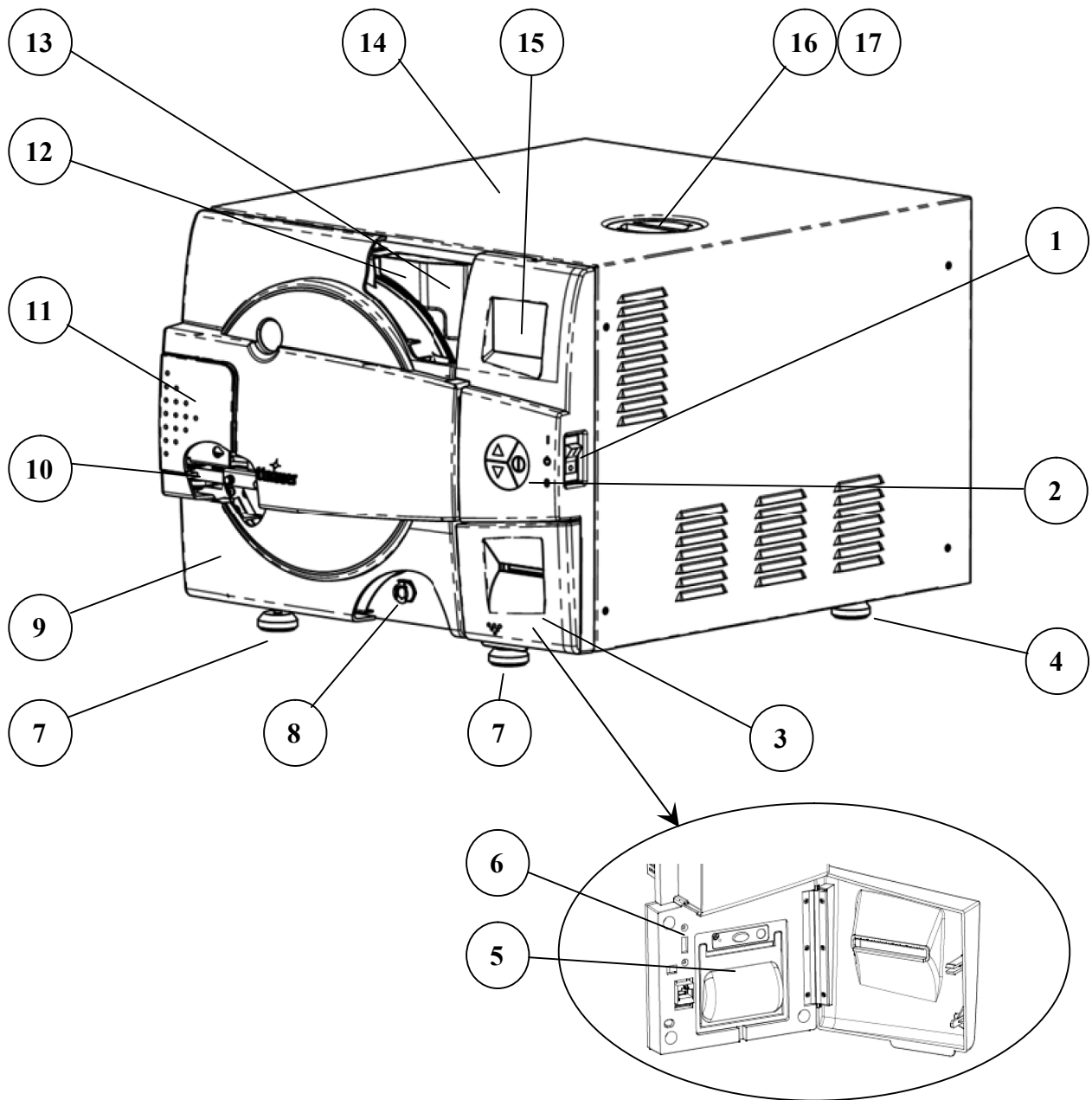

No.	Description	No.	Description
1	Main switch circuit breaker	10	Door switch
2	Operating keyboard	11	Door closing device
3	Printer cover	12	Water reservoir funnel
4	Rear Leg	13	Water level gauge
5	Printer (option)	14	Autoclave cover
6	USB connection	15	Display

7	Front Legs	16	Mineral-free water reservoir cover
8	Mineral-free water reservoir drain valve	17	Safety valve
9	Door cover		

3.16 Rear View: EL 2840

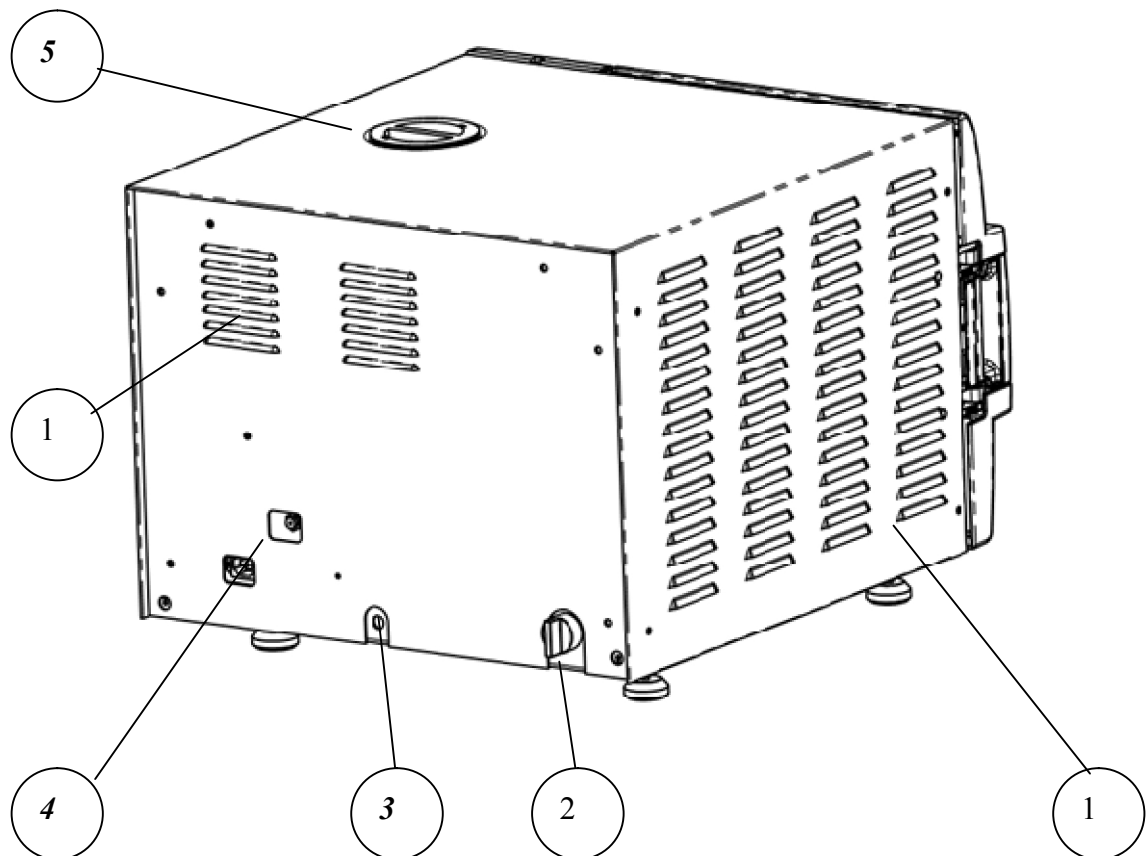

No.	Description
1	Ventilation grills
2	Drain line water strainer
3	Compressed air inlet (optional) or overflow
4	Main power electric cable socket
5	Mineral-free water reservoir cover

3.17 Rear View: ELPV 2840

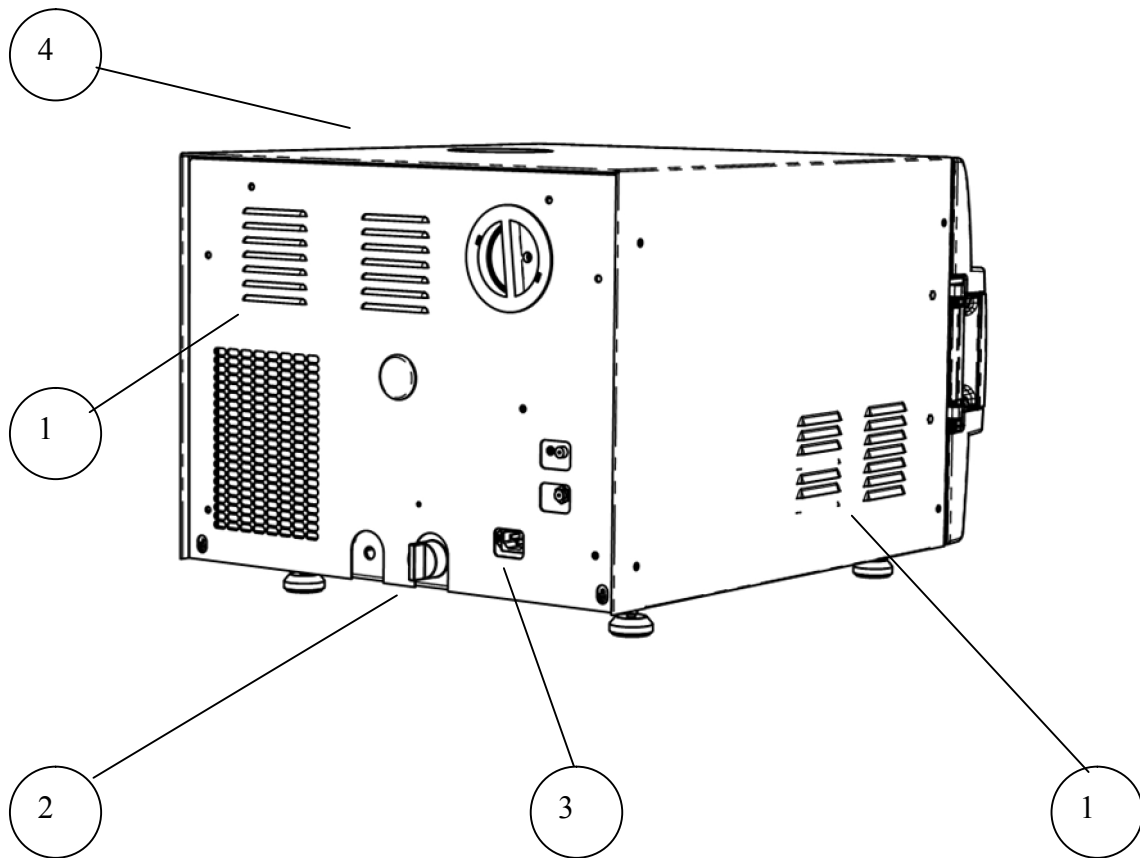

No.	Description
1	Ventilation grills
2	Drain line water strainer
3	Main power electric cable socket
4	Mineral-free water reservoir cover

4 Control Panel

4.1 Control Panel Drawing

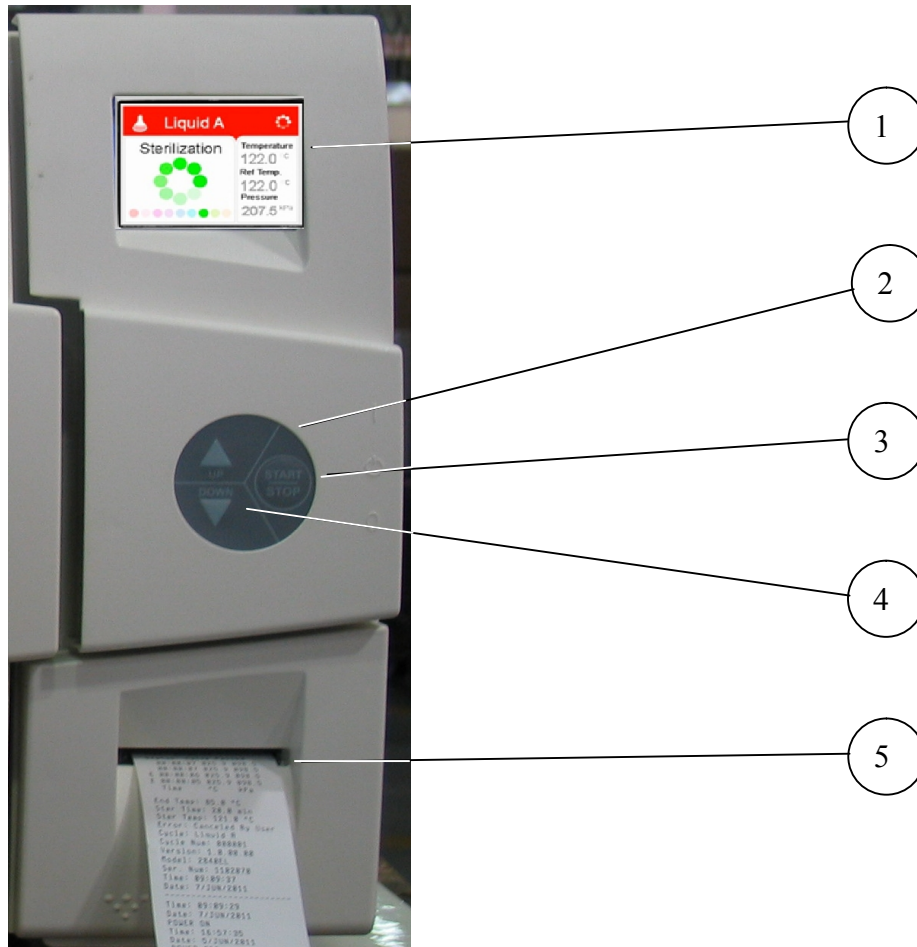

No.	Description
1	Display
2	Keypad: Up Button
3	Keypad: Start/Stop Button
4	Keypad: Down Button
5	Printer

4.2 Description and Functions of the Front Panel Keyboard

The front panel is composed of 3 sections:

1. Display screen.
2. Keypad.
3. Printer

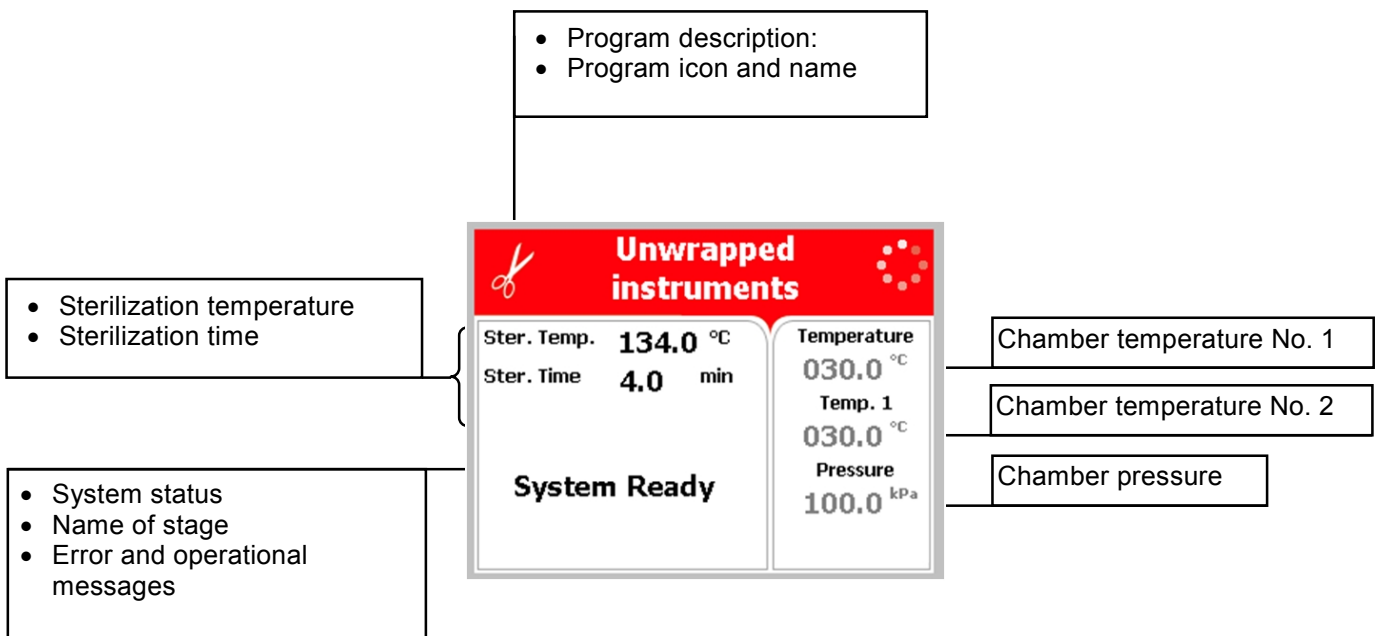

4.2.1 Display screen

The display is a LCD panel used to display the current status of the autoclave while using Operational Messages and Error Messages.



4.2.2 Keypad

The keypad consists of three keys as described below:

<p>UP key</p> <p>This key has the following functions:</p> <ul style="list-style-type: none"> • In the menu directories: <ul style="list-style-type: none"> ○ This key enables the operator to browse through the cycles. • In the directories available: <ul style="list-style-type: none"> ○ When the cursor is blinking on a number, the UP ▲ key increases its value. ○ When the cursor is blinking on a menu selection, the UP ▲ key allows browsing backward through the menu. ○ When adjusting a parameter and the cursor is blinking on “SET” or “EXIT” the UP ▲ key activates that procedure.” 	
<p>DOWN key</p> <p>This key has the following functions:</p> <ul style="list-style-type: none"> • In the menu directories: <ul style="list-style-type: none"> ○ This key enables the operator to browse through the cycles. • In the directories available: <ul style="list-style-type: none"> ○ When the cursor is blinking on a number, the DOWN ▼ key decreases its value. ○ When the cursor is blinking on menu selection, the DOWN ▼ key allows browsing forward through the menu. ○ When adjusting a parameter and the cursor is blinking on “SET” or “EXIT” the DOWN ▼ key activates that procedure. 	
<p style="text-align: right;">START/STOP key</p> <p>This key has the following functions:</p> <ul style="list-style-type: none"> • In the main screen: <ul style="list-style-type: none"> ○ Starts the process when the required program was chosen. ○ Stops the current process. ○ Cancels the ERROR message displayed on the screen and opens the electric door lock. • In the menu directories: <ul style="list-style-type: none"> ○ When the cursor is blinking on a number, the START/STOP ① key enables moving to the next position. ○ When the cursor is blinking on a menu selection, the START/STOP ① key activates that selection. 	

4.2.3 Printer

The printer is an optional device.

It prints the detailed history of each cycle performed by the autoclave. The printing is on thermal paper with 24 characters per line and records the sterilization cycle information for subsequent consideration.



4.3 Displayed Error Messages / Symbols

The failures are divided into two categories.

1. Failure that occur before completing the sterilization stage, which in this case will leave the load unsterilized
2. Failure that occur after completing the sterilization stage, which in this case will leave the load sterilized









For the list of Displayed Error Messages / Symbols see **TROUBLESHOOTING**







4.4 Displayed operational messages / Symbols

Message / Symbol Name	Message / Symbol Description	Required Action
	This symbol is displayed when the door is open.	Close the door.
Door is open (during stand by)	This message is displayed when the door is opened:	Close the door to perform a new cycle.
Cycle Ended	This message is displayed when the cycle ended successfully.	Press START/STOP in order to perform a new cycle.
Test Ended	This message is displayed when the test ended.	Press START/STOP in order to perform a new test
	This symbol is displayed when Cycle by Clock mode is performed.	Enter the Admin menu as described in this manual to change the time or to cancel this option.

<p>Cycle by clock</p>	<p>This message is displayed if the user presses START/STOP key while the "cycle by clock" mode is active.</p>	<p>Enter the Admin menu as described in this manual to change the time or to cancel this option.</p>
<p>Atmospheric pressure not set</p>	<p>This message is displayed in order to set the atmospheric pressure by opening the door for 5 minutes.</p>	<p>Open the door for 5 minutes in order to set the Atmospheric pressure.</p>
<p>Critical settings have been updated, Please restart machine in order for changes to be updated</p>	<p>If a change of the autoclave setting was made, a restart operation is required.</p>	<p>Restart the autoclave in order for changes to be updated.</p>
	<p>This message is displayed if the electrode in the chamber senses water.</p>	<p>You can still open the door.</p>

5 Sterilization Programs

Sterilization Programs			Temp.	Sterilization Time (minutes)	Drying Time (minutes)	C models only	PV models only	BH models only
Icon	No.	Name						
	1.	Glass	134°C (273°F)	3	1			
	2.	Plastic	121°C (250°F)	15	1			
	3.	Liquid A	121°C (250°F)	15				
	4.	Liquid B – Waste*	121°C (250°F)	30				
	5.	Liquid A – Cooling*	121°C (250°F)	15		√		
	6.	Liquid B Waste Cooling*	121°C (250°F)	30		√		
	7.	Bio Hazard 1*	134°C (273°F)	30	1			√
	8.	Bio Hazard 2*	121 (250°F)	45	1			√

Sterilization Programs			Temp.	Sterilization Time (minutes)	Drying Time (minutes)	C models only	PV models only	BH models only
Icon	No.	Name						
	9.	Bio Hazard Liquids*	121 (250°F)	45				√
	10.	Vacuum test (PV only)*		5 +10			√	
	11.	Warm-Up*	80 °C (176°F)	20				
	12.	Isotherma I*	80 °C (176°F)	20				
	13.	Air Mixture*	121°C (250°F)	15				
	14.	Glass Test*	121°C (250°F)	20				
	15.	Durham*	121°C (250°F)	15				

***These programs are optional**

During the process, the stages of the cycle will be displayed on the screen:

The stages names are as follows:

- Start
- Pulse Low (PV models only)
- Pulse High (PV models only)
- Water Inlet
- Heating
- Sterilization
- Cooling (C models only)
- Exhaust
- Drying (PV model only)
- Ending

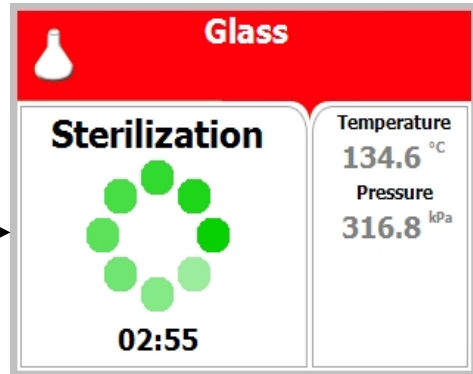

5.1 Program 1: Glass

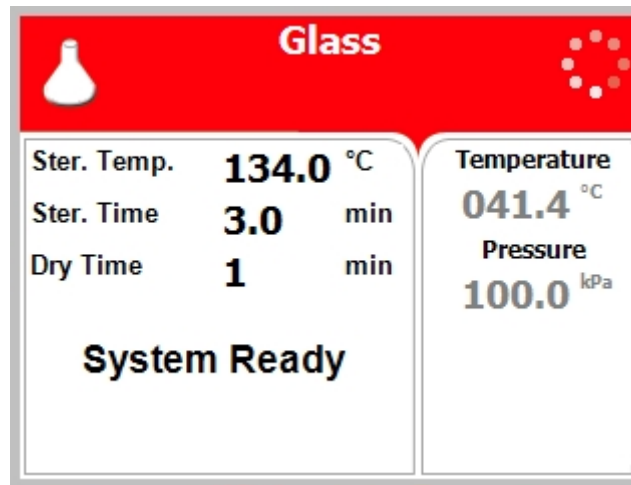

For glass instruments, when the manufacturer recommends autoclaving at temperatures of 134°C (273°F). Drying stage is available for PV (pre-vacuum) models only.

Nominal parameters default settings

- Sterilization temperature: 134°C (273°F).
- Sterilization time: 3 minutes.
- Drying time: 1 minute. (PV – pre-vacuum models only).

Operations sequence:

- (PV, pre-vacuum models only) **Pulse low/Pulse high:** at one pulse it will build vacuum down to 25 kPa.
- **Water Inlet:** Water enters the chamber
- **Heating:** The chamber and is heated by actuation of electrical heaters until the sterilization temperature is reached.
- **Sterilization:** Sterilization temperature is maintained constant during the sterilization time.
- **Cooling:** N/A.
- **Fast Exhaust:** the steam is exhausted out of the chamber at a fast rate until pressure decreases to ambient pressure.
- (PV, pre-vacuum model only) **Drying:** vacuum is built up and the air pump is working.
- **Ending:** The system checks that End temperature and End pressure have been reached, and then releases the door.

5.2 Program 2: Plastic

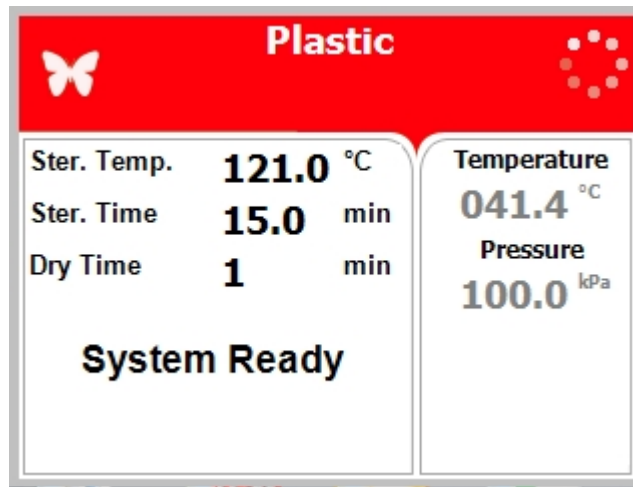

For plastic and other delicate instruments, when the manufacturer recommends autoclaving at temperatures of 121°C (250°F). Drying stage is available for PV (pre-vacuum) models only.

Nominal parameters default settings

- Sterilization temperature: 121°C (250°F)
- Sterilization time: 15 minutes
- Drying time: 1 minute (PV – pre-vacuum models only).

Operations sequence:

- (PV, pre-vacuum models only) **Pulse low/Pulse high:** at one pulse it will build vacuum down to 25 kPa.
- **Water Inlet:** Water enters the chamber
- **Heating:** The chamber is heated by actuation of electrical heaters until the sterilization temperature is reached.
- **Sterilization:** Sterilization temperature is maintained constant during the sterilization time.
- **Cooling:** N/A
- **Fast Exhaust:** the steam is exhausted out of the chamber at a fast rate until pressure decreases to ambient pressure.
- (PV, pre-vacuum models only) **Drying:** vacuum is built up and the air pump is working.
- **Ending:** The system checks that End temperature and End pressure have been reached, and then releases the door.

5.3 Program 3: Liquid A

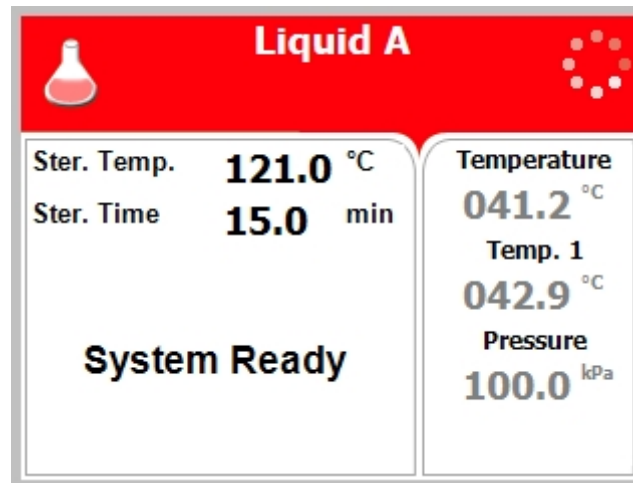

For liquids when the manufacturer recommends autoclaving at temperatures of 121°C (250°F) for 15 minutes.



Cautions!

Both PT100 temperature sensors must be inside the bottles.
For proper sterilization, fill the bottles with approximately the same amount of liquid.

Nominal parameters default settings

- Sterilization temperature: 121°C (250°F)
- Sterilization time: 15 minutes

Operations Sequence

- (PV, pre-vacuum models only) **Pulse low/Pulse high:** at one pulse it will build vacuum down to 25 kPa.
- **Water Inlet:** Water enters the chamber
- **Heating:** The chamber is heated by actuation of electrical heaters until the sterilization temperature is reached.
- **Sterilization:** Sterilization temperature is maintained constant during the sterilization time.
- **Cooling:** N/A
- **Slow Exhaust:** Steam is exhausted from the chamber at a slow rate, until it reaches the pressure of 30 kPa above the ambient pressure. Then steam is exhausted out of the chamber at a fast rate until pressure decreases to ambient pressure.
- **Drying:** N/A
- **Ending:** The system checks that End temperature and End pressure have been reached, and then releases the door.

5.4 Program 4: Liquid B – Waste

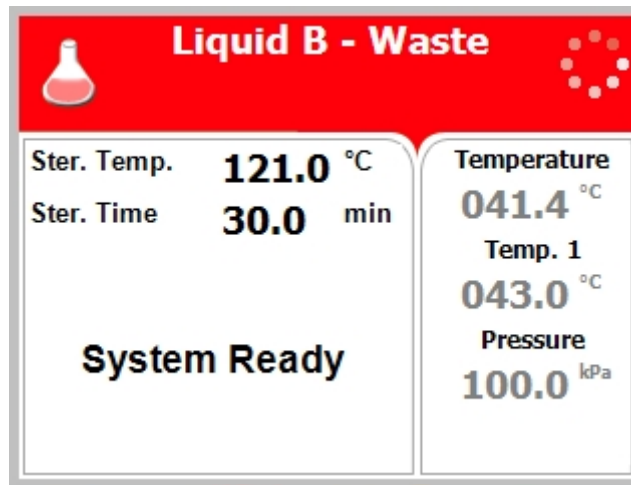

For liquids when the manufacturer recommends autoclaving at temperatures of 121°C (250°F) for 30 minutes, such as liquid waste.



Cautions!

Both PT100 temperature sensors must be inside the bottles.
For proper sterilization, fill the bottles with approximately the same amount of liquid.

Nominal parameters default settings

- Sterilization temperature: 121°C (250°F)
- Sterilization time: 30 minutes

Operations Sequence

- (PV, pre-vacuum models only) **Pulse low/Pulse high:** at one pulse it will build vacuum down to 25 kPa.
- **Water Inlet:** Water enters the chamber
- **Heating:** The chamber is heated by actuation of electrical heaters until the sterilization temperature is reached.
- **Sterilization:** Sterilization temperature is maintained constant during the sterilization time.
- **Cooling:** N/A
- **Slow Exhaust:** Steam is exhausted from the chamber at a slow rate, until it reaches the pressure of 30 kPa above the ambient pressure. Then steam is exhausted out of the chamber at a fast rate until pressure decreases to ambient pressure.
- **Drying:** N/A

- **Ending:** The system checks that End temperature and End pressure have been reached, and then releases the door.

5.5 Program 5: Liquid A – Cooling (C – cooling models only)

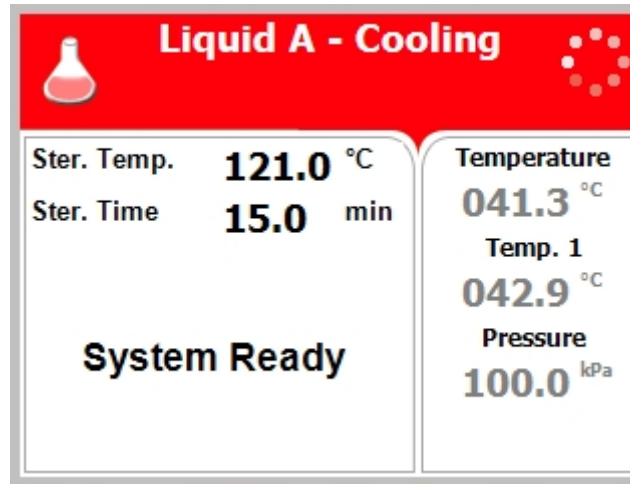

For liquids when the manufacturer recommends autoclaving at temperatures of 121°C (250°F). for 15 minutes.



Cautions!

Both PT100 temperature sensors must be inside the bottles.
For proper sterilization, fill the bottles with approximately the same amount of liquid.

Nominal parameters default settings

- Sterilization temperature: 121°C (250°F).
- Sterilization time: 15 minutes.

Operations sequence:

- (PV, pre-vacuum models only) **Pulse low/Pulse high:** at one pulse it will build vacuum down to 25 kPa.
- **Water Inlet:** Water enters the chamber
- **Heating:** The chamber is heated by actuation of electrical heaters until the sterilization temperature is reached.
- **Sterilization:** Sterilization temperature is maintained constant during the sterilization time.
- **Cooling:** Forced cooling to the required end temperature, chamber pressure remains at approx. 300 kPa and the cooling valve is opened.

- **Fast Exhaust:** the steam is exhausted out of the chamber at a fast rate until pressure decreases to ambient pressure.
- **Drying:** N/A
- **Ending:** The system checks that End temperature and End pressure have been reached, and then releases the door.

5.6 Program 6: Liquid B – Waste Cooling (C – cooling models only)

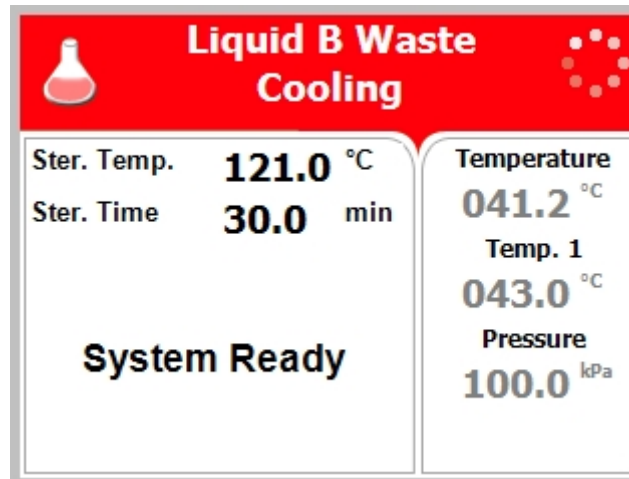

For liquids when the manufacturer recommends autoclaving at temperatures of 121°C (250°F) for 30 minutes, such as liquid waste.



Cautions!

Both PT100 temperature sensors must be inside the bottles.
For proper sterilization, fill the bottles with approximately the same amount of liquid.

Nominal parameters default settings

- Sterilization temperature: 121°C (150°F).
- Sterilization time: 30 minutes.

Operations sequence:

- (PV, pre-vacuum models only) **Pulse low/Pulse high:** at one pulse it will build vacuum down to 25 kPa.
- **Water Inlet:** Water enters the chamber
- **Heating:** The chamber is heated by actuation of electrical heaters until the sterilization temperature is reached.
- **Sterilization:** Sterilization temperature is maintained constant during the sterilization time.

- **Cooling:** Forced cooling to the required end temperature, chamber pressure remains at approx. 300 kPa and the cooling valve is opened.
- **Fast Exhaust:** the steam is exhausted out of the chamber at a fast rate until pressure decreases to ambient pressure.
- **Drying:** N/A
- **Ending:** The system checks that End temperature and End pressure have been reached, and then releases the door.

5.7 Program 7: Bio Hazard 1 (BH, bio-hazard models only)

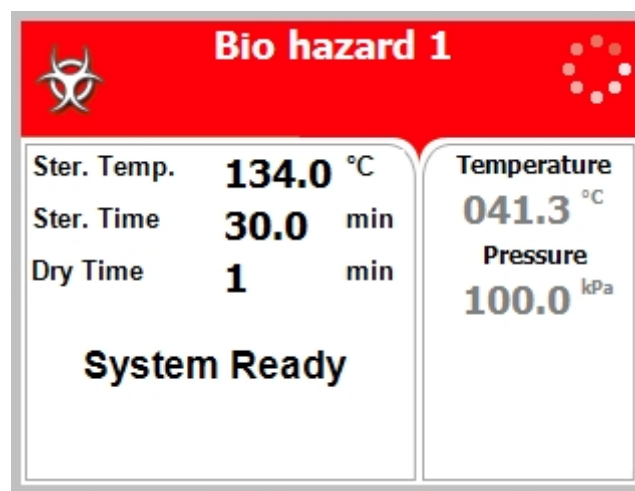

All exhaust from the chamber before completion of the Sterilization stage is performed through the bio-hazard filter. For instruments, when the manufacturer recommends autoclaving at temperatures of 134°C (273°F) for 30 minutes. Drying stage is available for PV (pre-vacuum) models only.

Nominal parameters default settings

- Sterilization temperature: 134°C (273°F)
- Sterilization time: 30 minutes
- Drying time: 1 minute. (PV – pre-vacuum models only).
-

Operations sequence:

- (PV, pre-vacuum models only) **Pulse low/Pulse high:** at one pulse it will build vacuum down to 25 kPa. **All exhaust from the chamber is performed through the bio-hazard filter.**
- **Water Inlet:** Water enters the chamber
- **Heating:** The chamber is heated by actuation of electrical heaters until the sterilization temperature is reached.
- **Sterilization:** Sterilization temperature is maintained constant during the sterilization time.

- **Cooling:** N/A
 - **Fast Exhaust:** the steam is exhausted out of the chamber at a fast rate until pressure decreases to ambient pressure.
- Note:** If the cycle fails, fast exhaust is performed through the bio-hazard filter. Some water may remain in the chamber after a failed cycle. To remove such water, press Start and repeat the cycle. If the problem persists, call for service.
- (PV, pre-vacuum models only) **Drying:** vacuum is built up and the air pump is working.
 - **Ending:** The system checks that End temperature and End pressure have been reached, and then releases the door.

5.8 Program 8: Bio Hazard 2 (BH, bio-hazard models only)

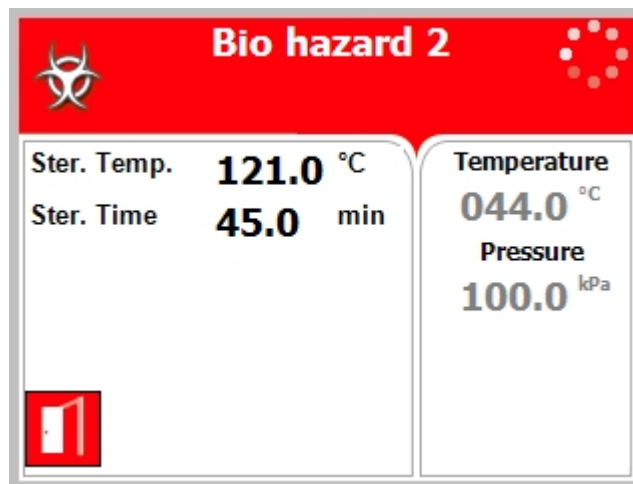

All exhaust from the chamber before completion of the Sterilization stage is performed through the bio-hazard filter. For instruments, when the manufacturer recommends autoclaving at temperatures of 121°C (250°F) for 45 minutes. Drying stage is available for PV (pre-vacuum) models only.

Nominal parameters default settings

- Sterilization temperature: 121°C (250°F)
- Sterilization time: 45 minutes
- Drying time: 1 minute. (PV – pre-vacuum models only).

Operations sequence:

- (PV, pre-vacuum models only) **Pulse low/Pulse high:** at one pulse it will build vacuum down to 25 kPa. **All exhaust from the chamber is performed through the bio-hazard filter.**
- **Water Inlet:** Water enters the chamber

- **Heating:** The chamber is heated by actuation of electrical heaters until the sterilization temperature is reached.
- **Sterilization:** Sterilization temperature is maintained constant during the sterilization time.
- **Cooling:** N/A
- **Fast Exhaust:** the steam is exhausted out of the chamber at a fast rate until pressure decreases to ambient pressure.
- **Note:** If the cycle fails, fast exhaust is performed through the bio-hazard filter. Some water may remain in the chamber after a failed cycle. To remove such water, press Start and repeat the cycle. If the problem persists, call for service.
- (PV, pre-vacuum models only) **Drying:** vacuum is built up and the air pump is working.
- **Ending:** The system checks that End temperature and End pressure have been reached, and then releases the door.

5.9 Program 9: Bio Hazard Liquids (BH, bio-hazard models only)

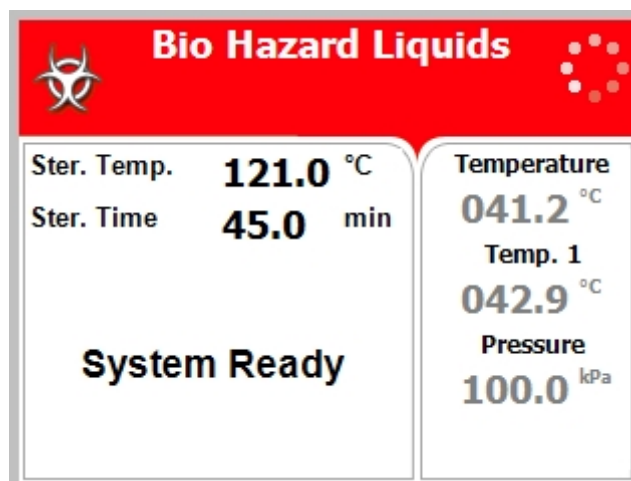

All exhaust from the chamber before completion of the Sterilization stage is performed through the bio-hazard filter. For liquids when the manufacturer recommends autoclaving at temperatures of 121°C (250°F) for 45 minutes.



Cautions!

Both PT100 temperature sensors must be inside the bottles. For proper sterilization, fill the bottles with approximately the same amount of liquid.

Nominal parameters default settings

- Sterilization temperature: 121°C (250°F)

- Sterilization time: 45 minutes

Operations sequence:

- (PV, pre-vacuum models only) **Pulse low/Pulse high:** at one pulse it will build vacuum down to 25 kPa. **All exhaust from the chamber is performed through the bio-hazard filter.**
- **Water Inlet:** Water enters the chamber
- **Heating:** The chamber is heated by actuation of electrical heaters until the sterilization temperature is reached.
- **Sterilization:** Sterilization temperature is maintained constant during the sterilization time.
- **Cooling:** N/A
- **Slow Exhaust:** Steam is exhausted from the chamber at a slow rate, until it reaches the pressure of 30 kPa above the ambient pressure. Then steam is exhausted out of the chamber at a fast rate until pressure decreases to ambient pressure.

Note: If the cycle fails, fast exhaust is performed through the bio-hazard filter. Some water may remain in the chamber after a failed cycle. To remove such water, press Start and repeat the cycle. If the problem persists, call for service.

- **Drying:** N/A
- **Ending:** The system checks that End temperature and End pressure have been reached, and then releases the door.

5.10 Program 10: Vacuum Test (PV, pre-vacuum models only)

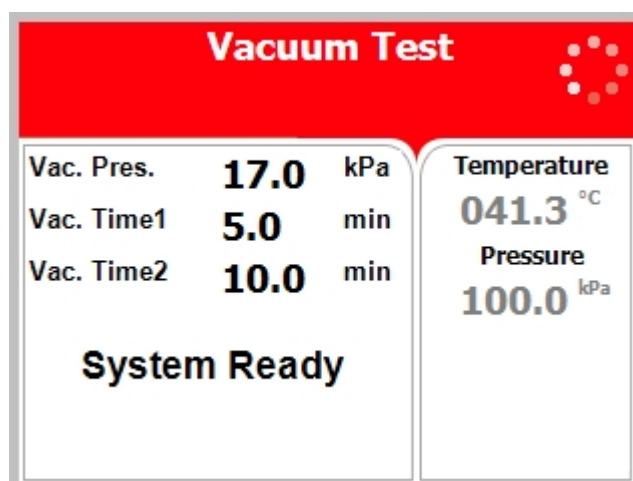

Vacuum Test is a test program with the following parameters:

Nominal parameters default settings

- Vacuum pressure: 17.0 kPa

- Vacuum time 1: 5 minutes
- Vacuum time 2: 10 minutes

Operations sequence:

- Vacuum is produced in the chamber down to P1=17 kPa. At this stage all the valves close. The autoclave remains in this stage for 5 minutes. This period enables the condition in the chamber to reach equilibrium.
- After the 5 minutes have elapsed, the printer records the pressure that is referred to as P2. At this point the test begins and lasts 10 minutes.
- At the end of the test, the printer records the results. The pressure at the end of the test is referred to as P3. The rate of change of P3-P2 shall not exceed 0.13 kPa/min.).

5.11 Program 11: Warm-Up

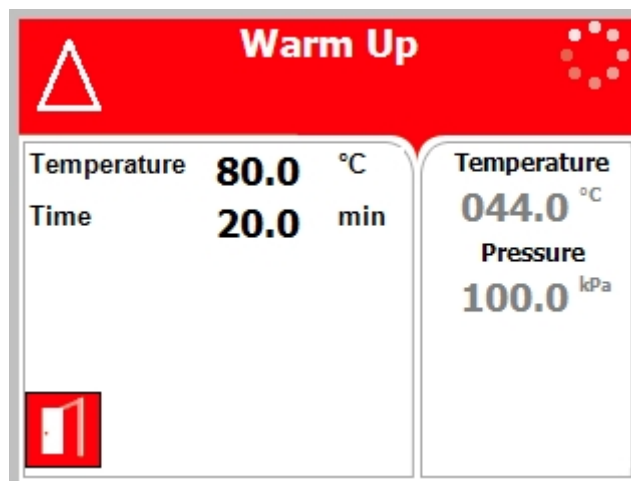

Pre-warming the chamber at 80°C (176°F) without drying.



Caution!

This is not a sterilization program!

Nominal parameters default settings

- Warm-up temperature: 80°C (176°F).
- Warm-up time: 20 minutes.

Operations sequence:

- **Pulse low/Pulse high: N/A**

- **Heating:** Water enters the chamber and is heated by actuation of electrical heaters until the warm-up temperature) is reached.
- **Warm up:** Warm up temperature is maintained constant for the warm-up time.
- **Sterilization:** N/A.
- **Cooling:** N/A.
- **Fast Exhaust:** the steam is exhausted out of the chamber at a fast rate until pressure decreases to ambient pressure.
- **Drying:** N/A.

Note: Some water may remain in the chamber.

5.12 Program 12: Isothermal

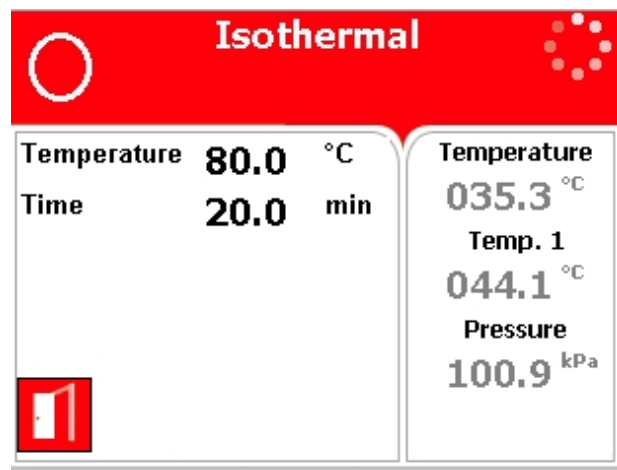

For liquids when the manufacturer recommends autoclaving at 60-100°C (140-212°F) with no drying. Recommending for melting of agar, pasteurization etc.



Caution!

This is not a sterilization program!

Put one PT100 inside the bottle, leave the second one hanging in the chamber outside the bottle (see below).



Nominal parameters default settings

- Heating temperature (default): 80°C (176°F).
- Heating time: 20 minutes.

Operations sequence:

- **Water Inlet:** Water enters the chamber
- **Heating:** The chamber is warmed up until the Keep-Heat temperature is reached inside the chamber.
- **Keep Heat:** Keep-Heat temperature is maintained constant for the preset Keep-Heat time.
- **Cooling:** N/A.
- **Fast Exhaust:** the steam is exhausted out of the chamber at a fast rate until pressure decreases to ambient pressure.
- **Drying:** N/A
- **Ending:** The system checks that End temperature and End pressure have been reached, and then releases the door.

Note: Some water may remain in the chamber.

5.13 Program 13: Air Mixture

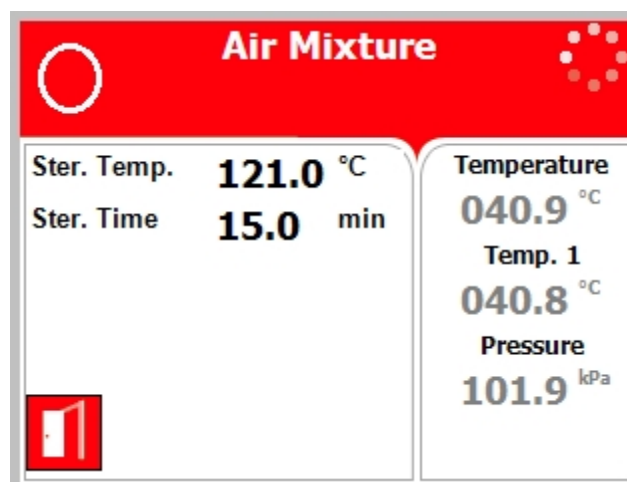

This program is intended for liquids in soft packages when the manufacturer recommends autoclaving at temperature of 121°C (250°F) for 15 minutes.

Sterilization is controlled in a way that the sterilization pressure remains approx. 30% above the theoretical pressure corresponding to the same temperature according to the steam table. These intends for prevent swelling or warping of the package.



Cautions!

Both PT100 temperature sensors must be inside the bottles.

For proper sterilization, fill the bottles with approximately the same amount of liquid.

Nominal parameters default settings

- Sterilization temperature: 121°C (250°F).
- Sterilization time: 15 minutes.

Operations sequence:

- **Heating:** Air enters the chamber followed by steam that heats it up until the sterilization temperature is reached. Air adds pressure needed to prevent swelling or warping of soft plastic items. Chamber fan is used to mix air with steam.
- **Sterilization:** Sterilization is controlled in a way that the sterilization pressure remains approx. 30% above the theoretical pressure corresponding to the same temperature according to the steam table.
- **Cooling:** Forced cooling to the required end temperature, chamber pressure remains at approx. 300 kPa and the cooling valve is opened.
- **Fast Exhaust:** The steam is exhausted out of the chamber at a fast rate until pressure decreases to ambient pressure.
- **Drying:** N/A
- **Ending:** The system checks that End temperature and End pressure have been reached, and then releases the door.

5.14 Program 14: Glass Test

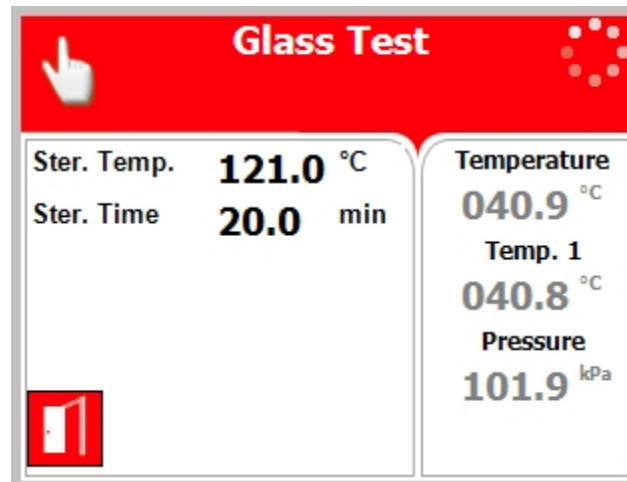

This cycle is intended to check the durability of the bottles for liquids when the manufacturer recommends autoclaving at temperatures of 121°C (250°F) for 20 minutes.



Cautions!

Both PT100 temperature sensors must be inside the bottles.
For proper sterilization, fill the bottles with approximately the same amount of liquid.

Nominal parameters default settings

- Sterilization temperature: 121°C (250°F).
- Sterilization time: 20 minutes.

Operations sequence:

- **Heating:** Steam enters the chamber and heats it up until the sterilization temperature is reached.
During the interval of the heating stage, between 100°C and 121°C, the heating rate is kept to approximately a rise of 1 degree per minute. This will make the last stage of the heating take approximately 21 minutes. This is to check the durability of the bottles.
- **Sterilization:** Sterilization temperature is maintained constant during the sterilization time.
- **Cooling:** Forced cooling to the required end temperature, chamber pressure remains at approx. 300 kPa and the cooling valve is opened.
During the interval of the cooling stage, between 121°C and 100°C the cooling rate is kept to approximately a decrease of 1 degree per minute. This will make the last stage of the cooling

take approximately 21 minutes. This is to check the durability of the bottles.

- **Fast Exhaust:** The steam is exhausted out of the chamber at a fast rate until pressure decreases to ambient pressure.
- **Drying:** N/A
- **Ending:** The system checks that End temperature and End pressure have been reached, and then releases the door.

5.15 Program 15: Durham

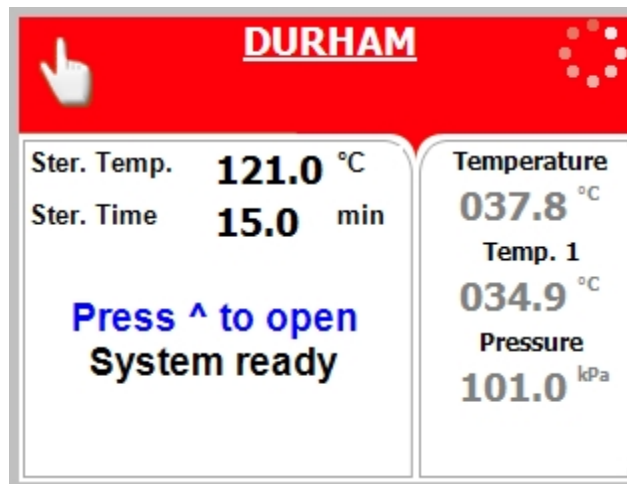

For liquids when the manufacturer recommends autoclaving at temperatures of 121°C (250°F) for 15 minutes.



Cautions!

Both PT100 temperature sensors must be inside the bottles.
For proper sterilization, fill the bottles with approximately the same amount of liquid.

Nominal parameters default settings

- Sterilization temperature: 121°C (250°F).
- Sterilization time: 15 minutes.

Operations sequence:

- **(PV, pre-vacuum models only) Pulse low/Pulse high:** at one pulse it will build vacuum down to 25 kPa.
- **Heating:** Steam enters the chamber and heats it up until the sterilization temperature is reached.
- **Sterilization:** Sterilization temperature is maintained constant during the sterilization time.

-
- **Slow Exhaust:** Steam is exhausted from the chamber at a slow rate, until chamber temperature reaches 105°C.
 - **Cooling:** Forced cooling to the required end temperature, chamber pressure remains at approx. 140kPa, and the cooling valve is opened.
 - **Fast Exhaust:** The steam is exhausted out of the chamber at a fast rate until pressure decreases to ambient pressure.
 - **Drying:** N/A
 - **Ending:** The system checks that End temperature and End pressure have been reached, and then releases the door.

6 Screens

6.1 Screens following a completely successful cycle – "Cycle Ended"

1. System Ready

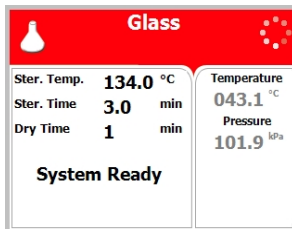

2. Pulse Low (ELPV model only)

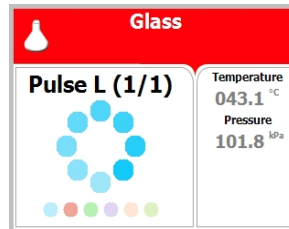

3. Pulse High (1/1) (ELPV model only)

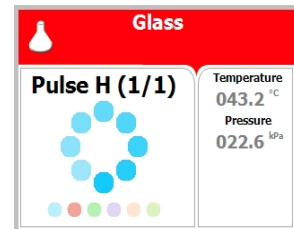

4. Insert Water

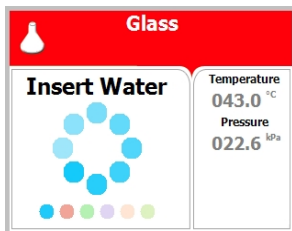

5. Heating

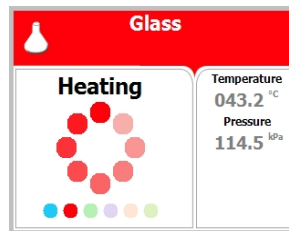

6. Sterilization

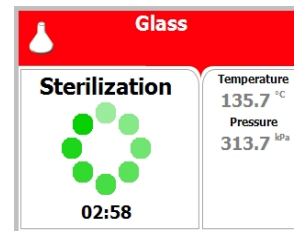

7. Exhaust

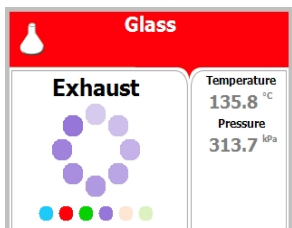

8. Drying (ELPV model only)

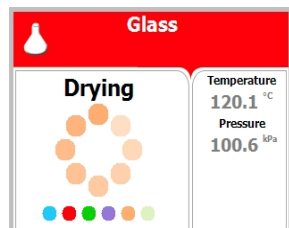

9. Ending

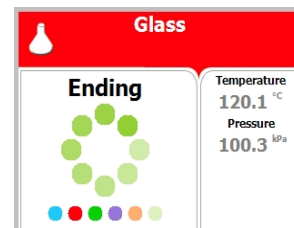

10. Cycle Ended

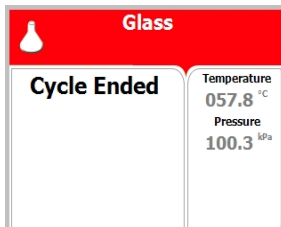

6.2 Screens following aborted cycles after complete sterilization stage

The sterilization phase ended successfully – cycle ended and the reason of failure is displayed

For example the next two scenarios:

6.2.1 Canceled by user after complete sterilization stage

The cycle ended successfully, the reason for aborted cycle is displayed.



6.2.2 Pressure Time Error Failure occurrence after complete sterilization stage

The cycle ended successfully, the reason of failure is displayed.

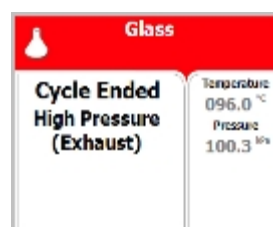

6.3 Screens following a fail cycle:

In this case, the display becomes yellow, a warning sign  and the reason of failure will be displayed.

For example the next two scenarios:

6.3.1 Failure according to Pressure Time Error



6.3.2 Failure according to Cancellation by user before complete sterilization stage

When "Cycle Failed" appears on the screen, the user shall press **START/STOP** key in order to delete the "Cycle Failed" message

An example for all displayed warnings according to Cycle Failed:

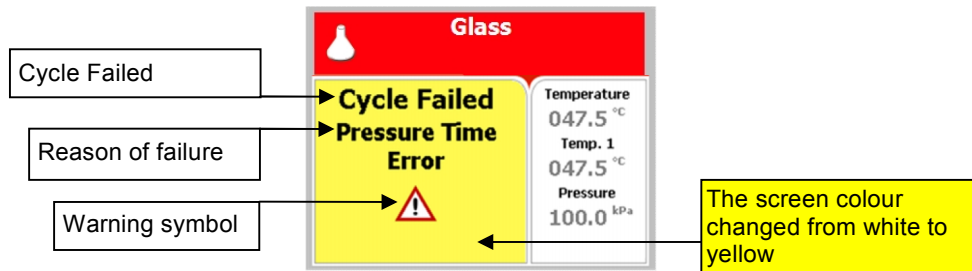

7 Printer

7.1 Printer Output

The printing is on thermal paper with 24 characters per line and contains the following information:

- Date:
- Time:
- Ser. Num:
- Model:
- Version:
- Cycle Num:
- Cycle:
- Ster Temp:
- Ster Time:

When the sterilization cycle begins the printer starts printing the above data.

After the preliminary printing, the autoclave starts performing the sequence of operations of the cycle. The measured values of temperature and pressure are printed at fixed time intervals, according to the phase of the process, as shown in the table on the next page.

The data is printed from the bottom up, beginning with the date and ending with "Cycle Ended". For an aborted cycle, "Cycle Failed" and the Error message are printed (refer to "Displayed Error Messages/Symbols").

For an example of a typical printout, see next page.

Note: Please note that the print out goes from the bottom upwards.

Printer output			Description
Operator:	_____		To be filled in manually by operator
Time:	12:14:47		Time sterilization cycle ended
Status: Cycle Ended			
00:24:43	101.3	099.7	Cycle finished time
D 00:31:23	101.9	023.4	The time, temperature and pressure during drying
D 00:28:23	106.2	109.7	The time, temperature and pressure during exhaust

E 00:23:43	107.0	107.4	The time, temperature and pressure during exhaust
E 00:22:08	134.5	311.9	The time, temperature and pressure during exhaust
CLK 2:	12:12:10:00		Sterilization Process End time as registered by two clocks
CLK 1:	12:12:10:00		
S 00:22:07	134.5	311.6	The time, temperature and pressure during sterilization
S 00:22:06	134.5	311.6	The time, temperature and pressure during sterilization
S 00:21:06	134.6	311.0	The time, temperature and pressure during sterilization
S 00:20:06	134.5	310.1	The time, temperature and pressure during sterilization
S 00:19:06	134.8	311.1	The time, temperature and pressure during sterilization
S 00:18:06	134.5	315.8	The time, temperature and pressure during sterilization
CLK 2:	12:08:08:00		Sterilization Process Start time as registered by two clocks
CLK 1:	12:08:08:00		
H 00:18:04	134.4	315.1	The time, temperature and pressure during heating
H 00:16:35	128.9	268.4	The time, temperature and pressure during heating
H 00:13:35	116.3	110.9	The time, temperature and pressure during heating
A 00:08:48	089.6	077.1	The time, temperature and pressure during air removal
A 00:05:48	091.3	049.4	The time, temperature and pressure during air removal
W 00:03:22	092.5	015.2	The time, temperature and pressure during water inlet
A 00:03:05	092.8	017.1	The time, temperature and pressure during air removal
A 00:00:05	098.3	101.6	The time, temperature and pressure during air removal
TIME	°C	kPa	
End Temp:	120.0 °C		
Ster Time:	7.0min		Sterilization time for selected program
Ster Temp:	134.0°C		Sterilization temperature in chamber for selected

		program
Cycle:	Unwrapped pouches	Cycle name
Cycle Num:	000082	Cycle number
Version:	1.0.00.00	Version A.B.CC.DD = 1.0.00.00 A: Door Type: Single Manual = 1 B: Vacuum Type = 0 C: Total number of Input/Output functionality that are not as default = 00 D: Total number of parameters values that are not as default = 00
Model:	2840 ELPV-D	Model name
Ser. Num:	000000000001	Model Serial number
Time:	11:50:05	Time sterilization cycle started
Date:	9/FEB/2010	Date sterilization cycle started

Time:	08:51:39	Time of turning on
Date:	9/FEB/2010	Date of turning on
POWER ON		The device is turned on
Time:	00:00:00	Time of turning off
Date:	9/FEB/2010	Date of turning off
POWER OFF		The device is turned off

Legend				
W	Insert Water	S		Sterilization stage
F	Steam Flush	CLK 1		Real Time Clock
A	Air removal stage	CLK 2		Software clock
H	Heating stage	E		Exhaust stage
K	Keep Heat (Optional)			
D	Drying Stage (ELPV Model only)			

7.2 Printer Handling

7.2.1 Maintenance

Wipe off the soiling on the printer surface with a dry soft cloth with a weak neutral detergent. After that, wipe the printer with a dry cloth.

7.2.2 Setting paper

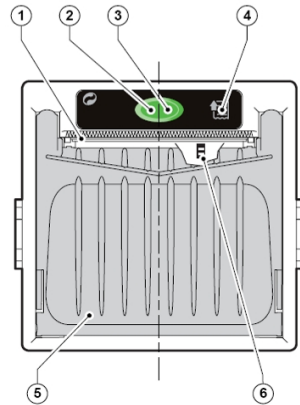

Printer model PLUS II Front view

- 1-Paper mouth
- 2-STATUS Led (blinking – no paper, steady – status is OK)
- 3-OPEN key (for paper roll compartment opening)
- 4-FEED key
- 5-Paper roll compartment
- 6-Paper end sensor

Fig. 1

1. Open the printer's cover door (1) by pulling it up (see Fig. 2).

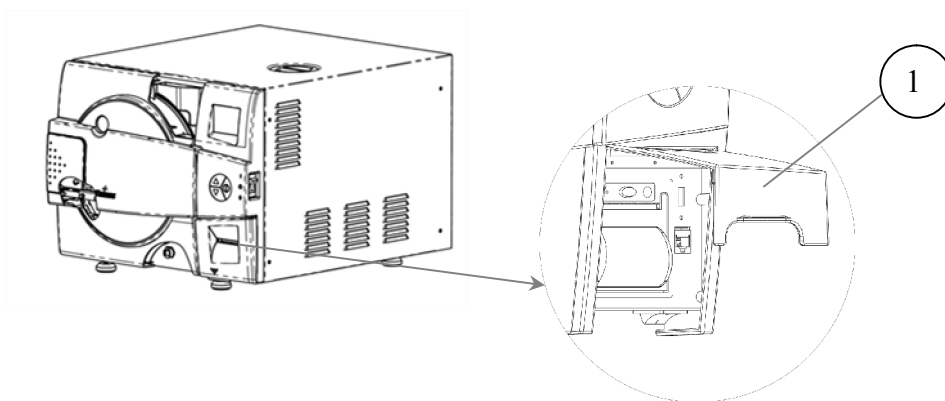

Fig. 2

2. Press the OPEN key to open the printer cover as shown (see Fig. 3/1). Handle the paper cutter carefully not to cut your hand.
3. Place the paper roll making sure it unrolls in the proper direction as shown (see Fig. 3/2).
4. Take out the paper and re-close the cover as shown (see Fig. 3/3) the printer cover is locked.
5. Tear off the exceeding paper using the jagged edge (see Fig. 3/4).

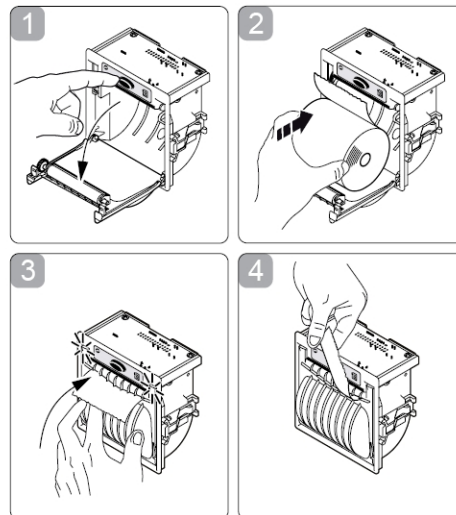

Fig. 3

6. Close the printer's cover door (3) by pressing corner (2), with the tip end of the paper emerging from the slot (1).

7.2.3 Notes on treatment of thermal papers:

- Store the papers in a dry, cool and dark place.
- Do not rub the papers with hard substance.
- Keep the papers away from organic solvent.

Cautions!



Never disassemble the printer. Failure to follow this instruction may cause overheating or burning of the printer or the AC adapter. Or an electric shock, which may lead to fires or accidents.

Never use the printer in a place of extreme humidity or any place where it can possibly be splashed by any liquids. If any liquids get into the printer, it could lead to fire, electric shock, or other serious accidents.

Never touch the thermal head immediately after printing because it becomes very hot. Make sure that the thermal head is cool before setting papers or cleaning the thermal head.

Power OFF the printer in any of the following cases:

- The printer does not recover from an error.
- Smoke, strange noise or smells erupt from the printer.
- A piece of metal or any liquid touches the internal parts or slot of the printer.

8 Installation

8.1 Placing



Caution!

The sterilizer is not portable or hand-held equipment; it is a fixed device so it is forbidden to move it.

The sterilizer must be placed on a rigid and leveled surface. The stand must be able to withstand the load of the device and loaded material.

1. **Counter top**

Able to support a minimum of 70 kg (154 lb).

2. **Counter space**

Min. 55cmW x 65cmD (22"W x 25"D) * (see unit dimensions).

When changing the autoclave location the door should remain open for at least 5 minutes in order to set the atmospheric pressure

8.1.1 Placing the Autoclave

Keep the back and the sides of the autoclave approximately 50 mm (2") away from the wall to allow ventilation and to facilitate the device disconnection.

If placed in a cabinet, verify that the rear of the cabinet is open to allow ventilation.

Insufficient space for ventilation may result in an increase of the autoclave's temperature that may damage the instrument.

It is recommended that enough space be left around the autoclave to give a technician access for servicing the machine.

8.1.2 Connections to Utility Supplies

Plug the power cord into the power supply output as specified in sec. 3.5 (Utilities).

8.2 Lifting and carrying



Caution!

Before moving the autoclave, Make sure that the electric cord is disconnected from the power, and there is no pressure in the chamber and in the generator.

To avoid injuries, lifting and carrying should be done with at least two persons or by using a fork-lift or any other mechanical aid.

Do not drop the device!

8.3 Filling the Mineral-Free Water Reservoir.



Before filling the reservoir, verify that the autoclave is idle and there is no pressure in the chamber.

1. Open the door (1).
2. Pour water, gently, into the front funnel (5) until it reaches the required level (3) on the side gauge. It is preferable to use a carafe.

Please note that the side gauge is divided into three sections. The bottom red section (4) indicates that the water level in the reservoir is too low. The middle blue section (3) shows that there is sufficient amount of water. The upper red section (2) indicates that the water level in the reservoir is too high.



Caution!

Under no circumstance should water be filled above the top sign level (the line between section 2 and 3) on the side gauge.

3. If the reservoir is empty, it is recommended to add water directly into the reservoir, as follows:



Before filling the reservoir, verify that the autoclave is idle, disconnected from the electrical supply and there is no pressure in the chamber.

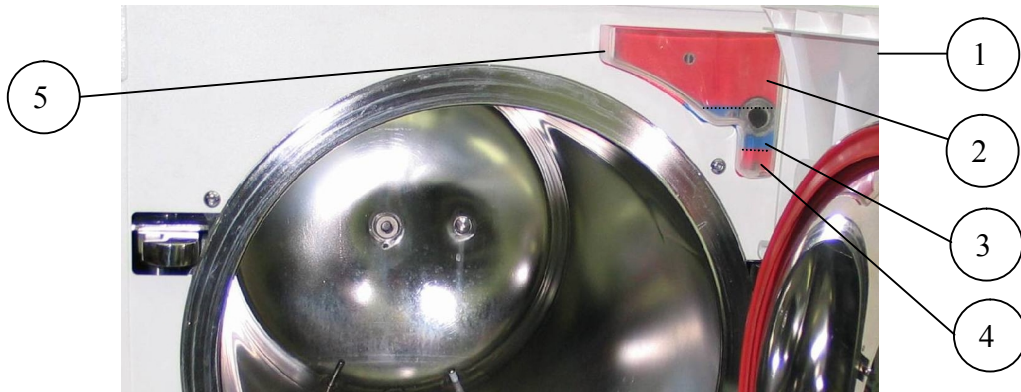

- ◆ Remove the water reservoir cover (6).
- ◆ Pour distilled water into the reservoir through the opening on top of the autoclave until it reaches the base of the safety valve holder (7).



Caution:

Under no circumstance should water be filled above the safety valve holder.

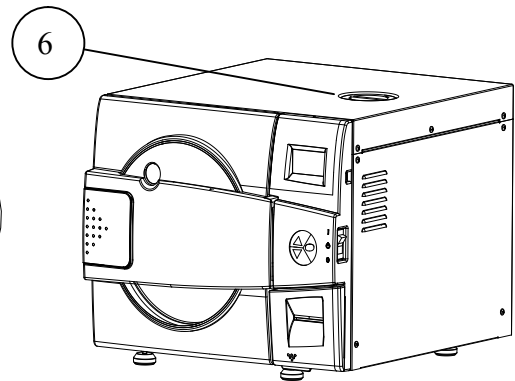
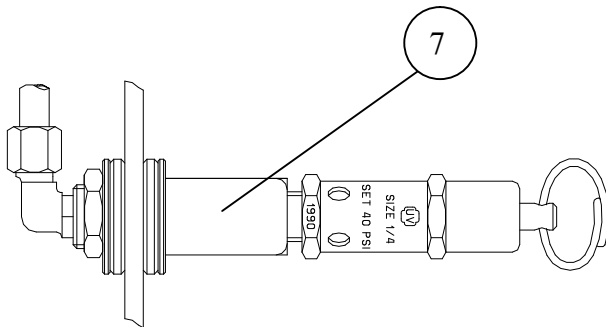

In case more water is added accidentally above the top sign level on the side gauge, decrease the water level by draining the reservoir before starting a cycle (see sec. 12.2).



Caution:

Use only water having the characteristics as per table in sec. 3.9. Tap water may clog the system and using them can invalidate the manufacturer's guarantee.

USE DISTILLED WATER ONLY. The impurities in tap water will create the need for more frequent cleaning and maintenance.

9 Preparation before Sterilization

The purpose of packaging and wrapping of items for sterilization is to provide an effective barrier against sources of potential contamination in order to maintain sterility and to permit aseptic removal of the contents of the pack. Packaging and wrapping materials should permit the removal of air from the pack, penetration of the sterilizing water vapor into the pack and removal of the sterilizing vapor.

The basic principle determining the size, mass and contents of instrument and hollowware packs is that the contents are sterile and dry immediately on completion of the cycle and removal of the pack from the sterilizer chamber.

Instruments to be sterilized must be clean, free from any residual matter, such as debris, blood, pads or any other material. Such substances may cause damage to the contents being sterilized and to the sterilizer.

1. Before use, check inside the autoclave chamber to ensure that no items have been left from the previous cycle.
2. Immediately after use, clean instruments thoroughly to dispose of any residue.
3. It is recommended to wash instruments with an ultrasonic cleaner, using detergent and mineral-free water.
4. Launder textile wraps prior to reuse.
5. After cleaning, rinse instruments for 30 seconds. (Follow manufacturer's instructions on the use of products for cleaning and lubricating instruments after using the ultrasonic cleaner).
6. Materials, including materials used for inner wraps, shall be compatible with the item being packed and the sterilizing method selected.
7. Do not place materials to be sterilized directly on the chamber's wall. Place the material only on trays, rack, etc.

9.1 Instruments

1. Before placing an instrument on the sterilizer tray, make sure that instruments which are not of the same metal, (stainless steel, carbon steel, etc.) are separated and placed on different trays.
2. Place empty containers upside down to prevent accumulation of water.

Note: Check manufacturer's instructions for the sterilization of each item.

3. In case carbon steel instruments are placed on the stainless steel tray, the tray should be lined with a towel or paper wrap before placing the instruments on the tray. There should be no direct contact between the carbon steel and the stainless steel tray.

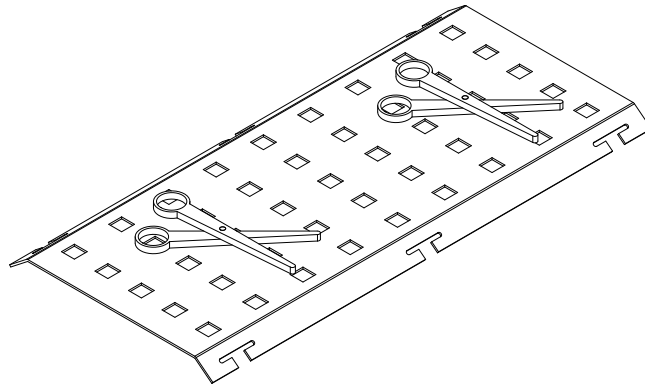

1. All instruments must be sterilized in an open position.
2. Use single-use wraps only once and discards them after use.
3. Place a sterilization indicator strip in each tray.
4. Place instruments with ratchets opened and unlocked or clipped on the first ratchet position.
5. Disassemble or sufficiently loosen multiple-part instruments prior to packaging to permit the sterilizing agent to come into contact with all parts of the instrument.
6. Tilt on edge items prone to entrap air and moisture, e.g. hollowware, so that only minimal resistance to removal of air, the passage of steam and condensate will be met.
7. Load items within the boundaries of the tray so that they do not touch the chamber walls, or fall off when the tray is moved.
8. The operator may use racks to allow adequate separation of packaged instruments.
9. Load trays in such a way as to allow steam to move freely among all items.
10. Once a week, use a biological spore test indicator in any load to make sure sterilization is performed.
11. Make sure that all instruments remain apart during the sterilization cycle.
12. Empty canisters should be placed upside-down, in order to prevent accumulation of water.

9.2 Wrapped Instruments

1. Wrapped instruments should be packed in material that promotes drying such as autoclave bag, autoclave paper, and muslin towels.
2. It is highly recommended to utilize the Tuttnauer™ Pouch Rack. This rack allows the operator to place pouches on their side, thus increasing the capacity of the autoclave significantly and promoting better drying of the instruments. Contact your dealer for details.

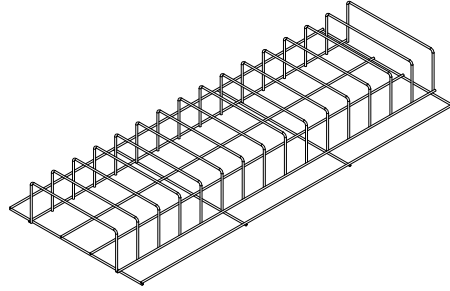

3. Verify that the packaging method is in accordance with good practice approach and the packaging materials are in accordance with the applicable standards (e.g. EN868 series).

9.3 Packs

1. Place packs upright on the tray, side by side.
2. Packs should not touch the chamber walls.

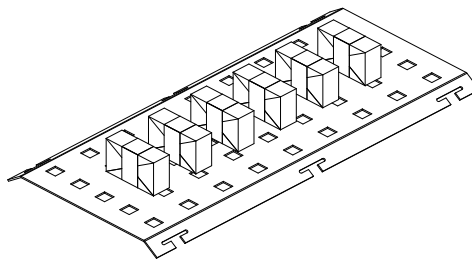

3. Pack instrument sets in a manner that prevents damage to delicate items.
4. Pack hollowware sets so that all openings face the same direction and so that the contents cannot move inside the pack.
5. Load packs of folded operating room drapes with layers vertical, allowing air to be removed from the packs rapidly.
6. Do not place packs of hollowware and trays of instruments above textile packs or soft goods in order to avoid wetting caused by condensation from items above.
7. Load items packed in flexible packaging materials on edge with paper to laminate, or flat with the paper surface downwards.

Note: The manufacturer's recommendations shall be observed, concerning the sterilization data for each type of material.

9.4 Tubing

When placing in a tray, Make sure that both ends are open, without sharp bends or twists.

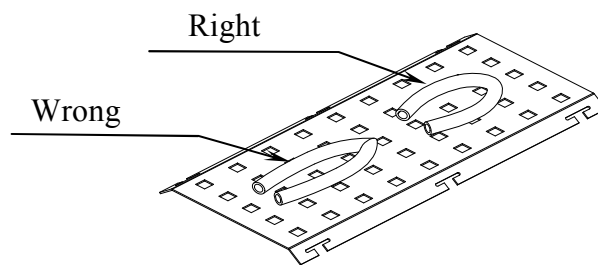

9.5 Liquids

1. Use only heat-proof glass, filled 2/3 full.
2. Ensure that the glass container is covered but not sealed to prevent pressure build-up.
3. Place the two temperature sensors into two separate liquid containers. These are used to control the program temperature and ensure the safety of the operating cycle.

Note: both PT100 temperature sensors must be inside the bottles

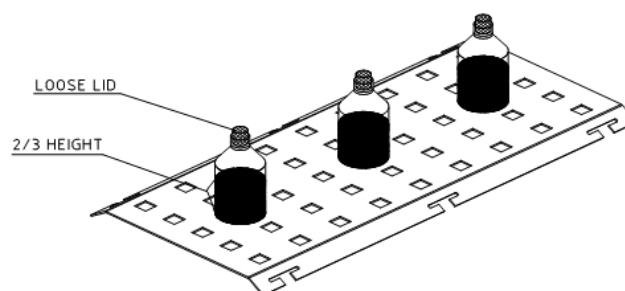

10 Operating Instructions

10.1 Turning on the autoclave

- To start the system, turn on the main white switch (1), located on the right side of the autoclave.

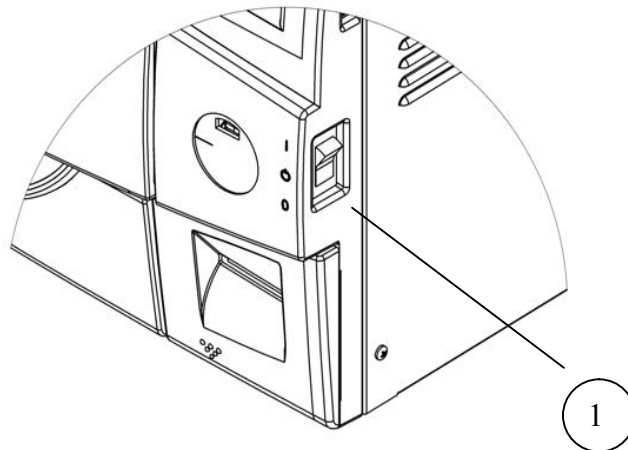

10.2 Opening the door

1. Place your thumb on the plastic door cover (1) and the other fingers in the handle (3).
2. Pull the handle (2) until the locking of the door is released.
3. Open the door.

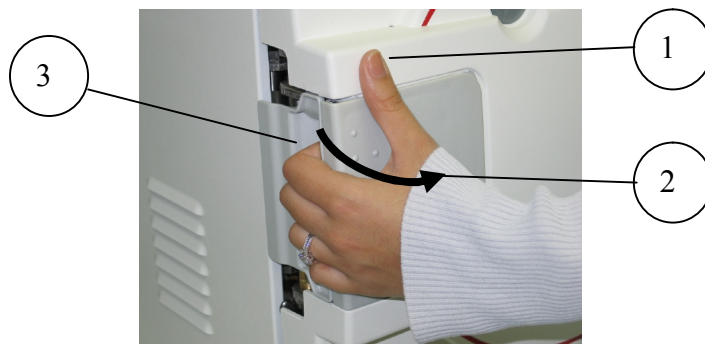

When the door is open, the door open sign  will be displayed.

10.3 Loading

- Load the autoclave properly according to instructions in sec. 9
PREPARATION BEFORE STERILIZATION

Please Mind:

- Compatible material
- Proper weight.

10.4 Operation

1. Select the program.
 - **UP** key: next program.
 - **DOWN** key: previous program.

Attention:

Selecting a program is possible only when the door is open.

2. Verify that you chose the required cycle.
3. If the autoclave is equipped with a printer verify that a paper roll is inserted in the printer. If not - insert as per para. 5.2.

10.4.1 Closing the door

1. Hold the opening handle in open position, while pushing the door until it comes to closed position, then release the handle.
2. The open door symbol  is replaced by the message "System Ready".

10.4.2 Starting cycle

Start the cycle by pressing the START/STOP key.

If your autoclave supports CFR 21 part 11 standard, perform the following procedure:

SELECT USER screen will be displayed:

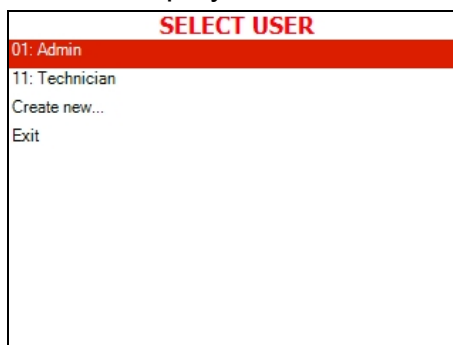

1. Enter the Enter Code screen by moving the cursor to your username (Use **Up** and **Down** keys) and pressing **START/STOP** key. The following screen will be displayed:

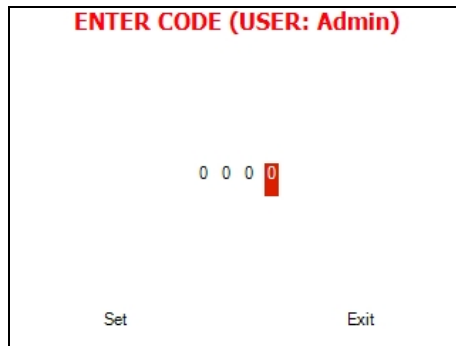

2. 0000 is displayed on the screen with the cursor blinking on the right digit.
3. To increase or decrease the digits, press the **UP** or **DOWN** keys.
4. Set your password, then move the cursor to **Set** by pressing the **START/STOP** key.
5. When **Set** is blinking, press the **UP** or **DOWN** keys to return to the program screen.

The autoclave starts performing sequence of operations. The actual measured values of pressure and temperature are displayed continuously and printed every minute at STE stage, and every 5 minutes at the other stages. The phase in progress is displayed at the right side of the upper line as WATER, HEAT, STER., and EXH.

If the operator presses the START key and the door is not completely closed, the process will not start and the DOOR indicator will flash twice then turn off and the buzzer will sound four times.



Caution!

Do not touch the strainer's cover, mounted on the exhaust line, during and short after operation.

Touching the hot strainer's cover may cause severe injuries.

10.5 Unloading

- When the cycle ended successfully (including pressing the **START/STOP** key, or any failure, after completing the sterilization stage) message "Cycle Ended" (and the relevant failure message, if applicable) is displayed on the screen.
- Verify than there is no pressure in the chamber, according to the reading on the display. Only then you may open the door.



Warning

**To avoid severe injuries from hot steam when opening the door:
It is strictly forbidden to lean on the autoclave.
It is strictly forbidden to place your hand or any part of your
body over the door.**

- Wear heat-resistant gloves or use the tray handle to remove the load from the autoclave
- On completion of the cycle, the load shall be visually inspected to ascertain that the load is dry, and that sterilization indicators have made the required color change.

10.6 Stopping the process and canceling the ERROR message

- It is possible to stop the program while the autoclave is operating. Pressing the **START/STOP** key at any stage of the process stops the operation. If the cycle was aborted before completing the sterilization stage, it will leave the load unsterilized.
- At the end of the aborted process (before completing the sterilization stage), "**Cycle Failed**" message, error message and a warning symbol  are displayed on the screen. Refer to "Displayed Error Messages/Symbols".
- Pressing the **START/STOP** key cancels the displayed message and enables opening the door.
If the door is not opened, the vacuum pump will stop automatically after 30 minutes (ELPV model only).



Warning

The load has not completed a sterilization cycle, therefore it is not sterile. Handle it as contaminated load.

10.7 Cycle by Clock mode (Start Cycle by Clock)

- This mode enables the operator to define the time of the beginning of the cycle. The maximum possible delay is 24 hours.

For more information, see sec. 7.7.1. Start Cycle by Clock

11 Checking and Changing Parameters and Other Data

Bacsoft control panel allows changing parameters of the cycle and of the system, exporting various data to, and importing from, a USB device or to the printer, and some other options.

Cycle parameters are changeable for Custom programs only (see Duplicate cycles), with the exception of the Temperature sensors, Displayed inputs, and Dry Time.

11.1 Browsing through the menus

Now you will learn how to browse through the folders. When you read the Directories and subdirectories chapter with links to specific menus, you will need to know how to browse through the folders using the autoclave control panel. Below is the instruction.

Login as User (see 10.4). The Main menu screen appears. To browse through the menus:

1. Press the Up and Down keys to scroll through the menus.
2. Press the Start/Stop key to enter the next screen (i.e. to get one level down).
3. Repeat steps 1 and 2 to enter the next screen until you get to required screen.

Below are the example screens for the following menu: Cycle Parameters\ Drying\ Dry Time:

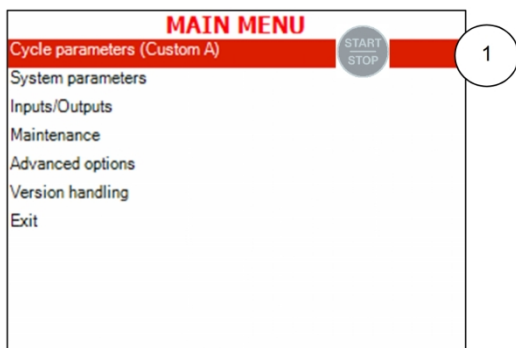

Login as Technician (see 1.4). The Main menu screen appears.
Press the Start/Stop key to enter the Cycle parameters menu.

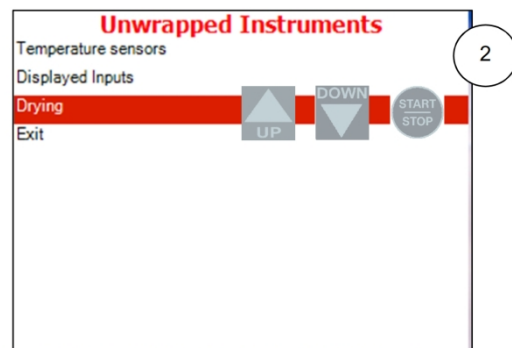

Press the Up and Down keys to scroll through the menu until you get to Drying, then press the Start/Stop key to enter the Drying menu.

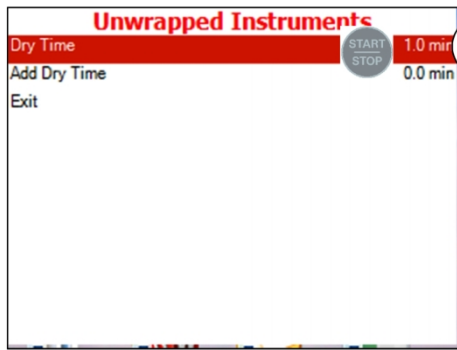

Press the Start/Stop key again to enter the Dry Time menu.



Now you have reached the required screen: Changing the dry time parameter. The path is: **Cycle parameters\Drying\Dry Time.**

Note: To exit every screen and to return to the previous screen (to get one level up):

- move the cursor to Exit by pressing the UP or DOWN keys and then press the Start/Stop key.
- or -
- press the UP and DOWN keys simultaneously.

In the next chapter you will see how to change the required parameter as desired.

11.2 Changing a Parameter

You have browsed through the menus and reached the parameter changing screen as explained above. Now you can change the required parameter as desired. To do so:

1. Enter the required value as follows:
 - Press the Up and Down keys to change the value of the digit.
 - Press the Start/Stop key to move the cursor to the next digit to the left.
2. When finished, press the Start/Stop key repeatedly until you move the cursor to Set.
3. Press the Up or Down key to confirm the new value and to exit the parameter changing screen.

Below is the typical parameter changing screen:

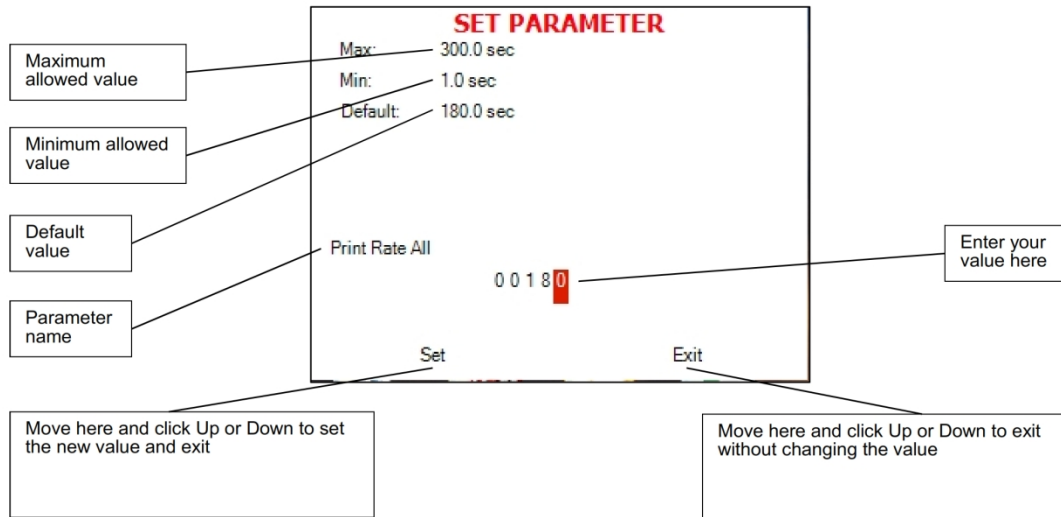

Note: Please note the maximum and minimum values for this parameter shown on the screen. Your value must be within these boundaries.
Below is the example of changing the Dry time parameter on the screen used in the previous section:

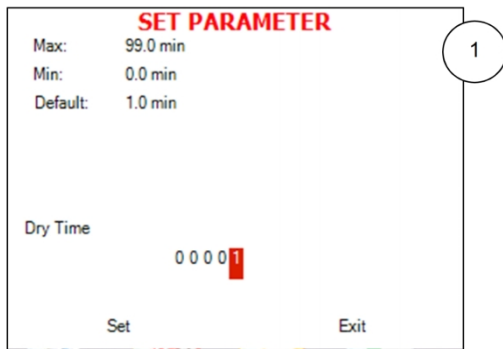

Browse to Changing dry time screen as explained in the previous chapter

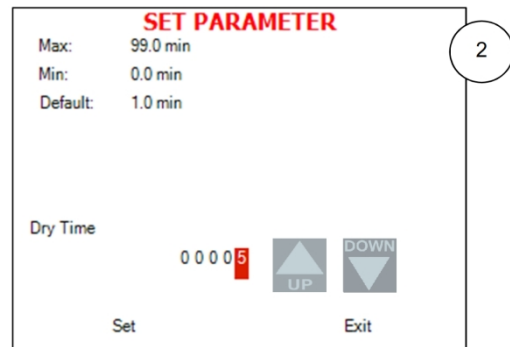

Use Up and Down keys to change the value of the digit

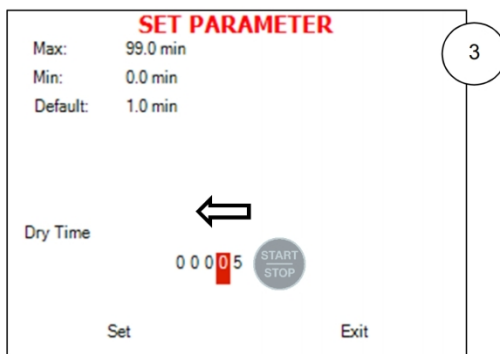

Press the Start/Stop key to move the cursor to the next digit to the left.

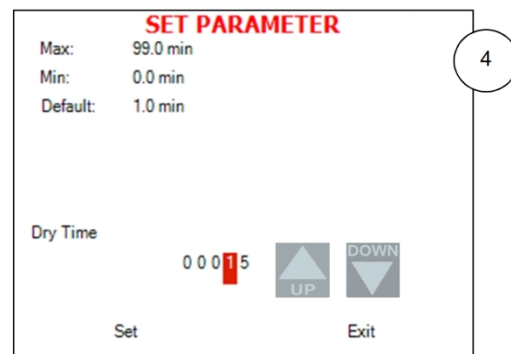

Press the Up and Down keys to change the value of the digit

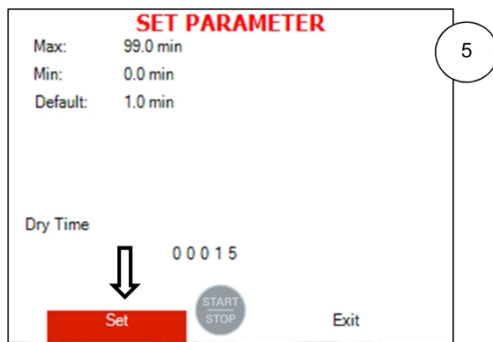

When finished, press the Start/Stop key repeatedly until you move the cursor to Set.

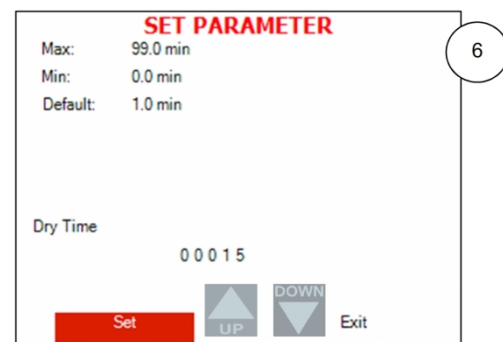

Press the Up or Down key to confirm the new value and to exit the parameter changing screen.

Note: To exit every screen and to return to the previous screen:

- move the cursor to Exit by pressing the UP or DOWN keys and then press the Start/Stop key

- or -

- press the UP and DOWN keys simultaneously

11.3 Quick options screen

When the autoclave is on and no cycle is running, press Up and Down keys simultaneously to enter the Quick options screen. Most of the options require login, and their availability depends on user authority (user, or technician). Login command is the last line on this screen. Quick options are options available without login.

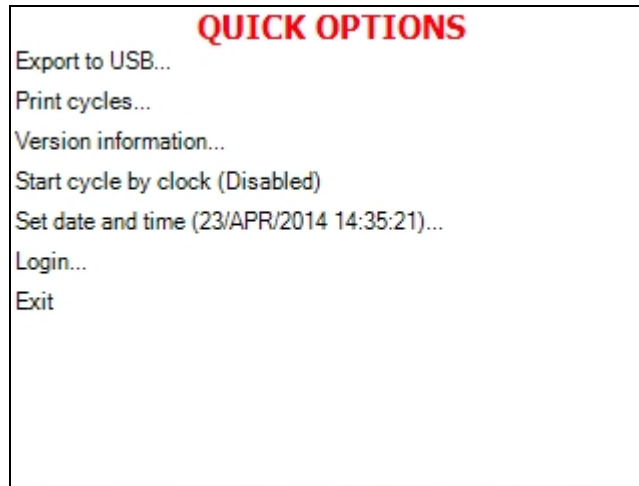

Below you can find instructions how to login and enter the Main menu. Section 10.1 above explains how to browse through the menus; section 10.2 explains how to change a parameter.

Below is the explanation of some Quick Options.

11.3.1 Version Information

This directory allows viewing information of the current, factory default, and previous software versions.

1. Enter the Version information screen.

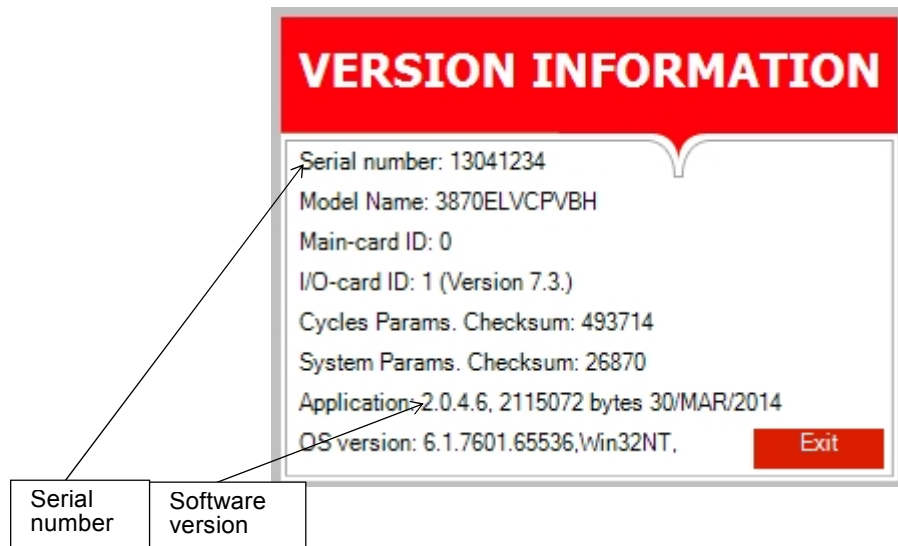

11.3.2 Start cycle by clock

This subdirectory enables the operator to start the cycle at the time set by this parameter.

1. Enter the Start cycle by clock screen. The following screen will appear:



On the Start cycle by clock screen, the time is displayed in the form "HH:MM". The hour range is 24 hours (i.e. from "0" to "24").

Setting the time to start the cycle

1. Move the cursor to the Time field.
2. Set the required time.

Enabling the Start Cycle by Clock

1. Set the starting time.
2. Move the cursor to Enabled. Press Up or Down key to enable starting cycle by clock.



1. Exit the Enabling the Start Cycle by Clock. The start cycle by clock icon appears on the display:

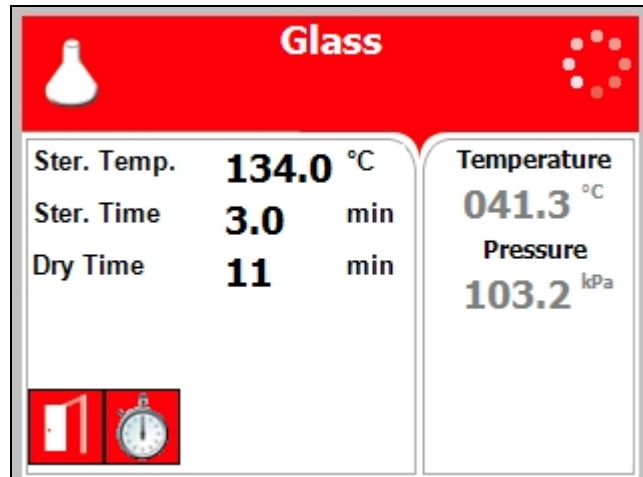

Disabling the START CYCLE BY CLOCK

2. On the Start Cycle by Clock screen, move the cursor to Disabled. Press Up or Down key to disable Starting cycle by clock.
3. Exit the Enabling the Start Cycle by Clock.

11.3.3 Set date and time

This subdirectory enables the operator to set date and time.

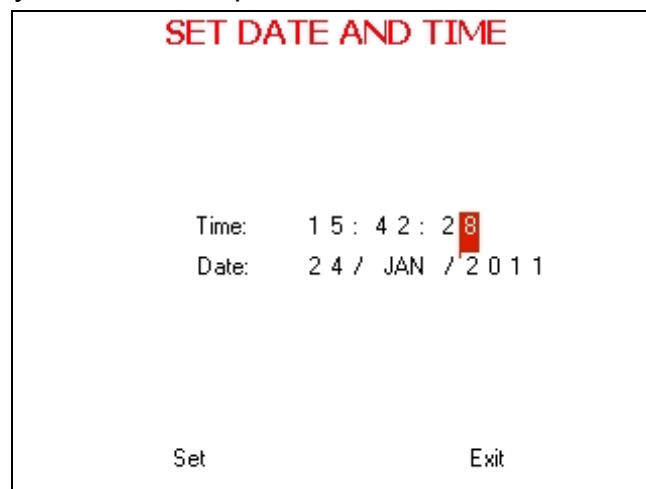

On the Set date and time screen, the time is displayed in the upper row in the form "HH:MM:SS". The hour range is 24 hour (i.e. from "0" to "24"). The date is displayed in the lower row in the form "DD: MMM: YYYY".

1. Set time and date
2. Exit the Set date and time screen. The following screen will appear:



Caution!

After setting time and date, turn the autoclave off and then on again.

11.4 Logging in and entering the Main menu

Below you can find instructions how to login and enter the Main menu. Section 10.1 above explains how to browse through the menus, section 10.2 explains how to change a parameter.

When the autoclave is on and no cycle is running, press the up and down keys simultaneously to enter the Quick Options screen (see 10.3). On this screen you can either proceed to login (see below) or choose one of the quick options available without login. To login as user:

1. On the Quick Options screen, choose login.
Select user screen appears.

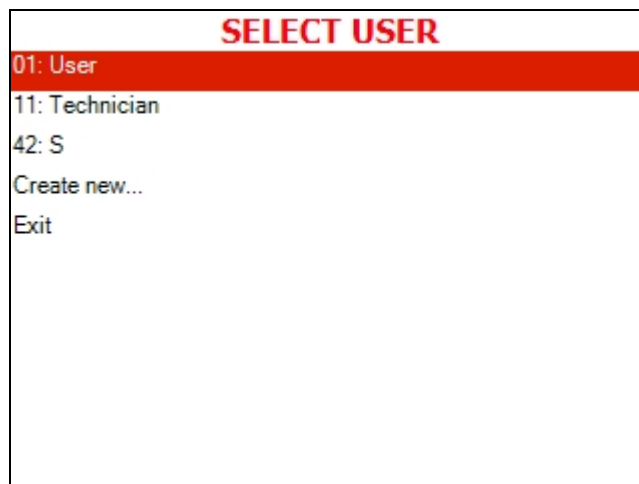

2. Choose User, then press the Start/Stop key to enter. The following screen will appear:

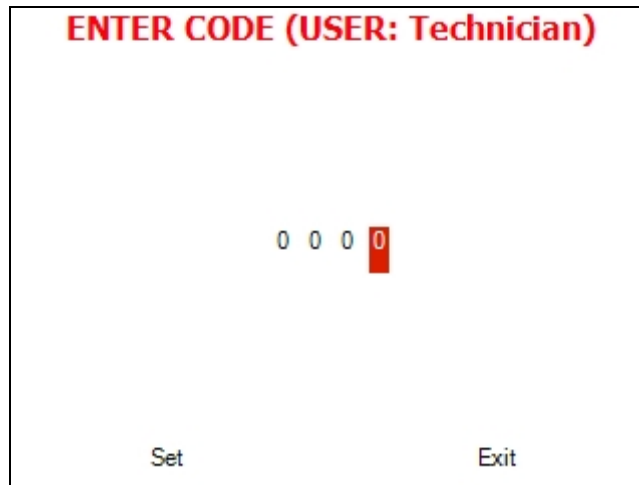

0000 is displayed on the screen with the cursor flashing on the right digit.

- Set the code to 0001. You will get to the Main menu.

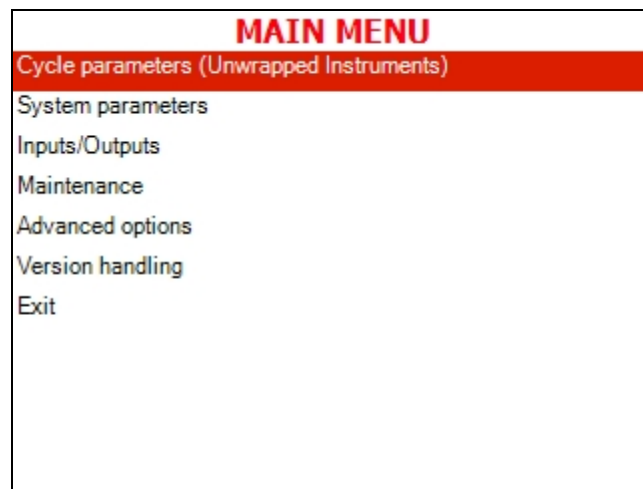

Below is the list and the explanation of some options available to user on the Main Menu.

11.5 Changing parameters

Bacsoft control panel provides an interface that consists of control screens available through an easy scrollable menu tree.

To learn how to scroll through the menus, change the parameters, and perform some other functions using our three-button keypad, see 10.1 and 10.2.

Below is the typical parameter changing screen:

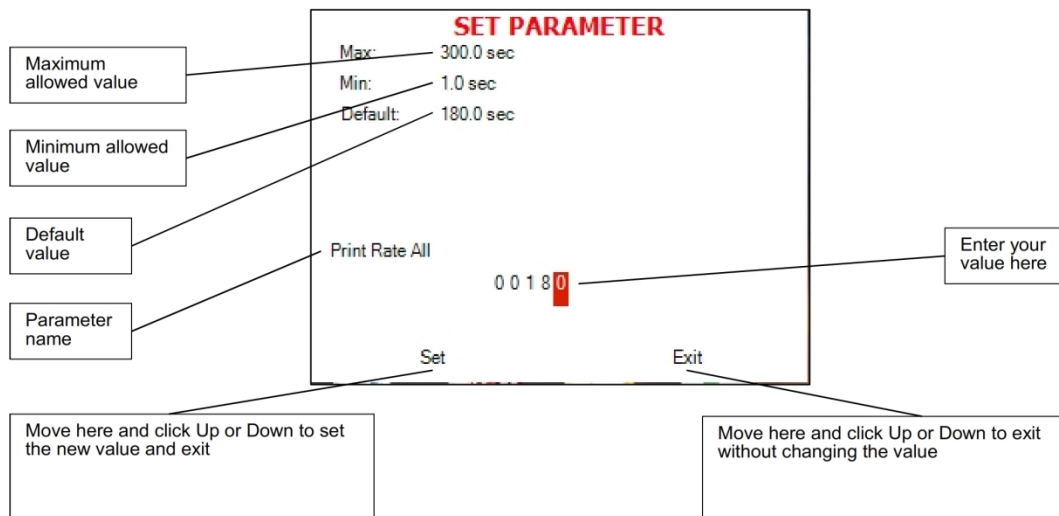

11.6 System Parameters

This menu is listing the system parameters that are the same for all cycles. Browse to the following folder:

Main menu\System parameters

You will see the following screen:

SYSTEM PARAMETERS	
Print Rate All	180.0 sec
Print Rate Sterilization	60.0 sec
Screen Saver	90.0 min
Pressure Calibration High	300.0 kPa
Pressure Calibration Low	25.0 kPa
Temperature Calibration High	130.0 °C
Temperature Calibration Low	60.0 °C
Cycle Print Gap	2.0
Exit	

11.6.1 Screen Saver

In this menu you can define the screensaver delay time, i. e. how long the keyboard will be untouched before the screensaver activates.

Browse to the following folder:

System parameters\Screen Saver

Change the parameter as desired.

11.7 Maintenance

Maintenance procedures provided by Bacsoft software allow you additional tests and USB input/output options.

Browse to the following folder:

Main menu\Maintenance

You will see the following screen listing the maintenance options:

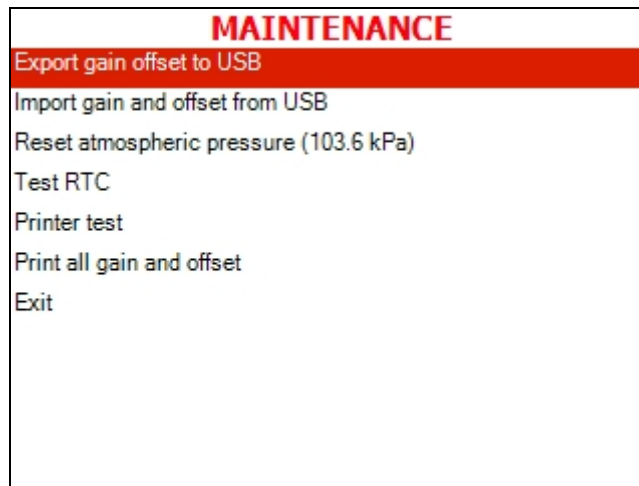

Below is the instruction for autoclave's maintenance menu.

11.7.1 Reset atmospheric pressure

In this menu you can reset the atmospheric pressure value. To do so:

1. Browse to the following folder:
Maintenance\Reset atmospheric pressure

The following screen will appear:



2. Leave the door open for 2 minutes at least. Ambient temperature should be less than 45°C.

Note: Please reset the atmospheric pressure when you install the autoclave for the first time, and each time you relocate or calibrate the autoclave.

11.7.2 Printer test

In this menu you can check the normal function of the printer. The printer will print the list of errors.

Browse to the following folder:

Maintenance\Printer test

The following screen will appear to confirm that the test has been done.



See the printout shown in the Printer handling chapter of the user manual.

11.8 Cycle parameters

The Cycle parameters menu includes parameters of a specific sterilization program (cycle). Browse to the following folder:

Main menu\Cycle parameters

You will see the following screen listing the cycle parameters:

Custom B
Temperature sensors
Displayed Inputs
Create Pulse
Keep Heat
Heating
Sterilization
Exhaust
Drying
Ending
Global
Exit

Note: For all the standard sterilization cycles, and for Bowie and Dick test, the only changeable cycle parameter is dry time (you will not see other parameters on your screen). For the custom cycles created by duplication, and for the Warm Up cycle, more options are changeable. Operator is not allowed to create custom cycles; only authorized technician can do this.

11.8.1 Dry Time

This parameter defines duration of the drying stage for the cycle.

1. Browse to the following folder:
Cycle parameters\Drying\Dry Time
2. Change the parameter as desired.

Drying stage is divided into two stages. For each stage you can set the total time, on time and off time. So during the Dry First Stage, the heating elements are on for the time set in Dry Heat On 1, then they go off for the time set in Dry Heat Off 1, and then this sequence is repeated during the entire Dry First Stage Time. The same is true for the Dry Second Stage.

11.8.2 Add Dry Time

This subdirectory allows you to change the Dry Time parameter for the current cycle.

Browse to the following folder:

- Cycle parameters\Drying\Add Dry Time
Change the parameter as desired.

12 Service and Maintenance Instructions

12.1 Preventive and Scheduled Maintenance

The maintenance operations described in this chapter have to be fulfilled periodically to keep the device in good condition and to reduce the breakdown time to a minimum.

The user can easily execute these operations in accordance with further instructions.

The owner of the autoclave is responsible to order an authorized technician to perform the periodical tests and preventive maintenance operations.

Use only mineral-free water as detailed in sec. 3.9 (water quality).



Warning:

Before carrying out any preventive maintenance operation, ensure that the electrical cord is disconnected and that there is no pressure in the autoclave.

12.1.1 Daily by the operator

Clean door gasket with a soft cloth. The gasket should be clean and smooth. A mild soapy solution may be used.

12.1.2 Weekly by the operator

Clean the water sensor in the rear of the chamber with a damp cloth or sponge. Cleaning the dirt off the sides of the sensor is more important than the tip (see sec. 12.5).

1. Check the interior of the autoclave. If the autoclave is dirty it requires cleaning as follows:

Take out the tray holder and trays. Clean the tray holder, trays and chamber's interior (especially its bottom part) with a cleaning agent & water. Wipe off the sediments from the chamber bottom with a sponge. Immediately after cleaning, rinse the tray holder, trays and chamber's interior with water to avoid stains on the metal.



Caution!

Do not use steel wool or steel brush as this can damage the chamber!

2. Clean the outer parts of the autoclave with a soft cloth.
3. Replace mineral free water in the reservoir.

Autoclaves without recycling of mineral free water

If the autoclave was not used, drain the water from the mineral free water reservoir once a week, and refill with fresh mineral-free water or distilled water (see sec. 12.2).

12.1.3 Periodically

By the operator

1. Once a month, activate the safety valve (see sec. 12.5).
2. Once a month clean the strainer as per sec. 12.6. Cleaning frequency may be reduced according to experience.
3. Check the door gasket every 12 months and replace it if required (see sec. 12.4).

By a qualified technician

Every 6 months

- Tighten the screws of the heaters and the electrical connections at the heaters, valves and connectors in the control box.
- Replace the air filter, every 6 months or after 1000 cycles (the shorter period).

Once a year

This operation shall be done by an authorized technician.

- Checking the continuity of the grounding connections.
- Calibration of the temperature and pressure.
- Perform validation of the autoclave.
- Checking the precise operation of the earth leakage relay.
- Checking that the autoclave is leveled.
- Checking the safety elements; safety valve, cut-off thermostat, door locking mechanisms.
- Checking the operation sequences, the sterilization parameters etc.
- Checking the water reservoir, piping, plastic parts and electric wires.
- Checking and tightening the piping joints to avoid leakage.
- Checking and tightening all screw connections in the control box, heaters and valves and instrumentation.

5 years

- Checking the door device for excessive wear.
- Performing safety tests: pressure vessel, efficiency, electrical, according to local rules or regulations.

To be performed only by an authorized inspector.

12.2 Draining the Reservoirs

If the autoclave is not equipped with automatic mineral-free water supply, this instruction applies to the clean-water reservoir and to the waste-water reservoir.

If the autoclave is equipped with automatic mineral-free water supply, this instruction applies to the clean-water reservoir only. In this case close the mineral-free water supply valve before draining the reservoir.

1. To drain the reservoir, use item (5) with the plastic hose (6) attached to it (supplied with the autoclave).
2. Insert part (5) into valve (3) and press it until you hear a “click”. The drain valve is open.
3. When the water reservoir is empty, press part (4). Item (5) will pop out approx. 3mm and the drain valve will be closed. Remove item (5) with the plastic tube.
4. If the drained reservoir is the clean-water reservoir, fill reservoir with distilled water until, reaches full level. (approximately 6.5 liters (1.72 gallons)).

The autoclave is now ready for use.

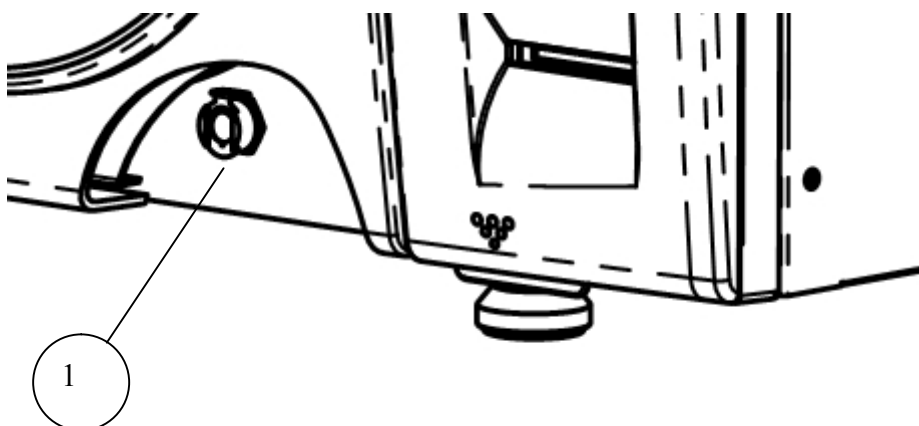

No.	description
1	Clean water drain

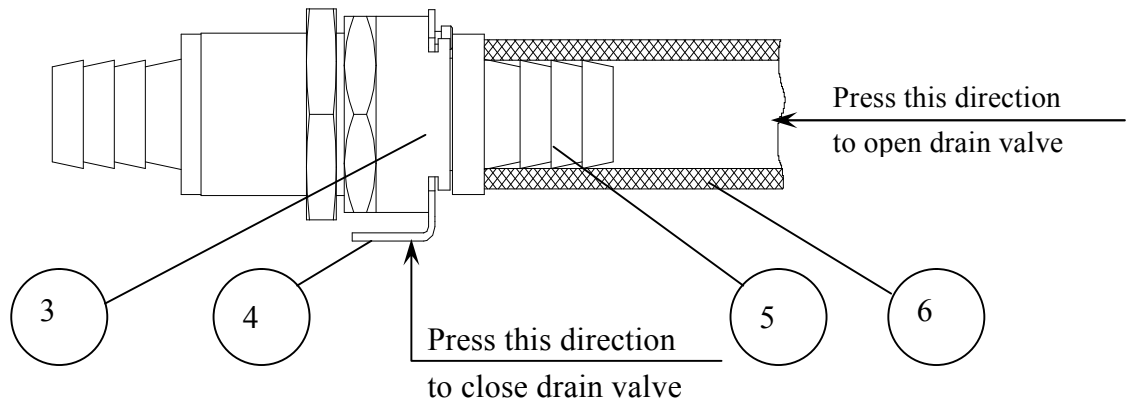

12.3 Cleaning the Air Jet

(Located in the water reservoir.)

A dirty air jet is the number one cause of failed spore tests

The elimination of air from the sterilization chamber during heat up is **critical** to the proper operation of the autoclave. Failure of the air removal system will be responsible for incomplete sterilization, indicator strips that do not turn, failed spore tests and aborted sterilization cycles. A clogged air jet will result in receiving the error message "Low Heat".

The air jet consists of a small orifice with a clean out wire inserted in it (wire is permanently installed and will not come out). It is required that the air jet be cleaned once per week or more often if necessary, to remove any accumulated dirt and debris.

It is preferred to clean the air jet when the unit is running a cycle and under pressure. Any loosened debris will be blown away, however, it can be done while the unit is idle.

1. Remove the water reservoir cover.
2. Clean the hole of the jet by manipulating the air trap wire back and forth 10 times.

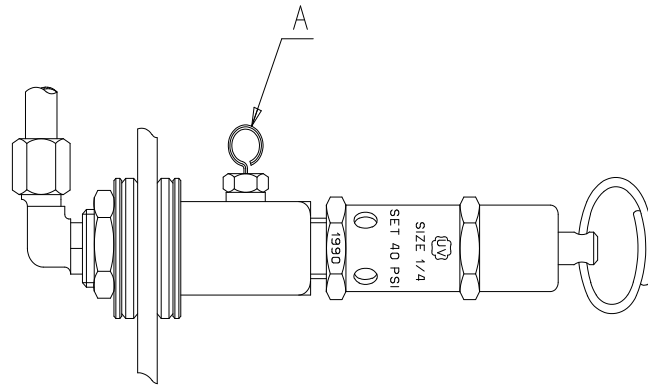

It is important to clean the hole of the air trap, as described at point 2 before starting operation of the autoclave, for the first time.

12.4 Replacing the Door Gasket



To avoid injuries replace the gasket while the autoclave is cold.

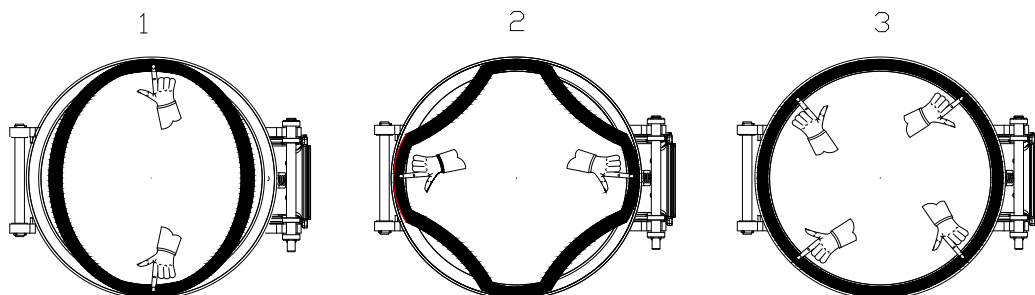

Pull off the gasket from the door groove and install the new gasket referring to the drawings as above points 1, 2 and 3.



Caution!

See drawing below for the right direction of the gasket.

12.5 Checking the Safety Valve

(Located in the water reservoir)

In order to prevent the safety valve from becoming blocked, it is necessary to allow the steam pressure to escape through it (every month).



To avoid injuries begin this check while the autoclave is cold.

1. Operate the sterilization cycle according to the manual.
2. Allow a pressure of approximately 200 kPa (29-psi) to build up in the chamber.
3. Remove water reservoir cover (1).
4. Pull the ring of the safety valve using a tool, i.e. screwdriver, hook etc and lift the safety valve ring for 2 seconds. Be careful not to burn your hands.
5. Press the STOP key to abort operation, and allow the steam to exhaust from chamber.
6. Wait until pressure goes down to zero, only then can the door be opened.

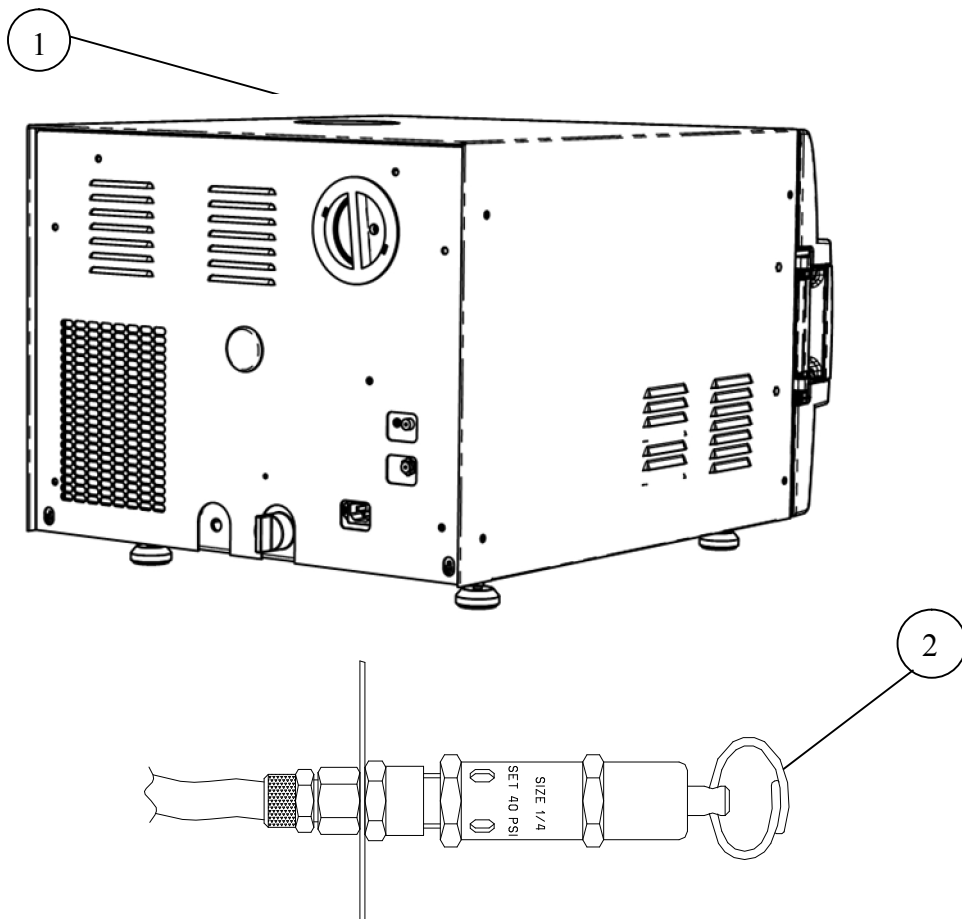

12.6 Cleaning the water outlet strainer



Caution!

Before proceeding, Make sure that the electric cord is disconnected and there is no pressure or water in the chamber.



Warnings

1. **The strainer's cover is HOT**
Do not touch the strainer's cap, mounted on the exhaust line, during and shortly after operation. Touching the hot strainer's cap may cause severe injuries.
2. **If maintenance operation is performed while strainer cap is hot, use heat resistant gloves to avoid injuries.**

1. Open the strainer cap.
2. Remove the strainer element.
3. Rinse the strainer with water, using a brush if necessary.
4. Reinstall the strainer element.
5. Close the strainer cap

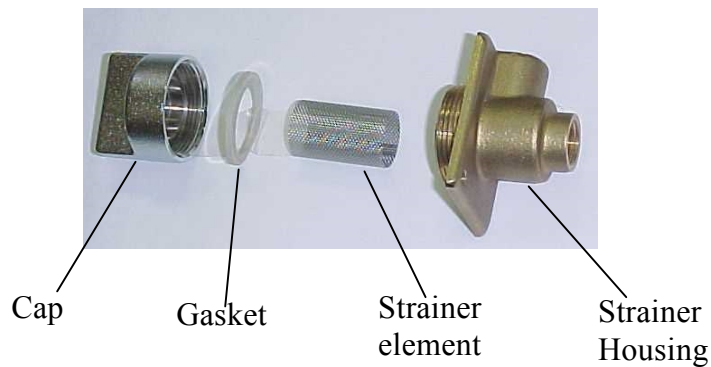
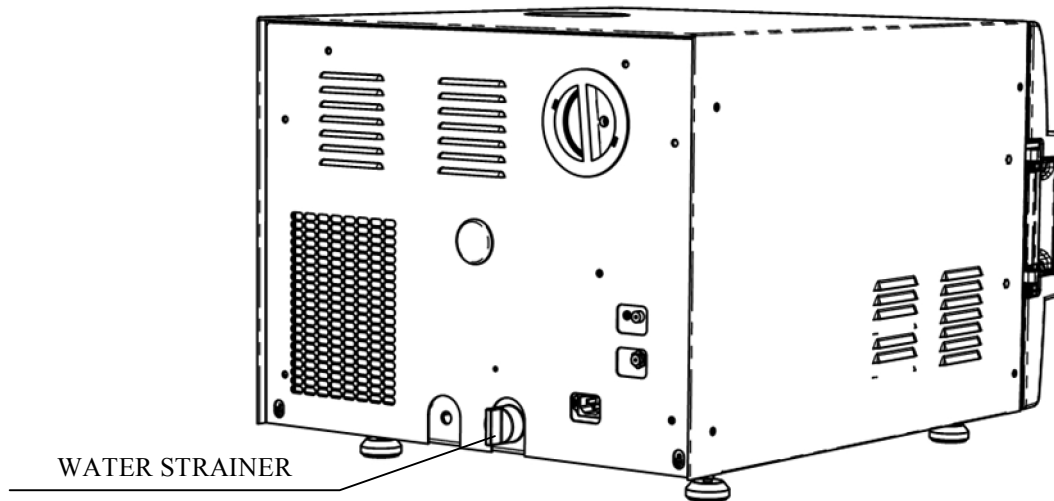

12.7 Cleaning the water sensor

It is required that the water sensor be cleaned at least once per week. Cleaning the sensor will ensure that the water level in the chamber is properly reported to the microprocessor all during the cycle.

The water sensor is located in the rear of the chamber. It is easily cleaned using a damp cloth or sponge, you may use a mild soapy solution if you like. It is important to wipe the sides of the sensor as well as the tip, to remove any dirt or debris that may have built up.

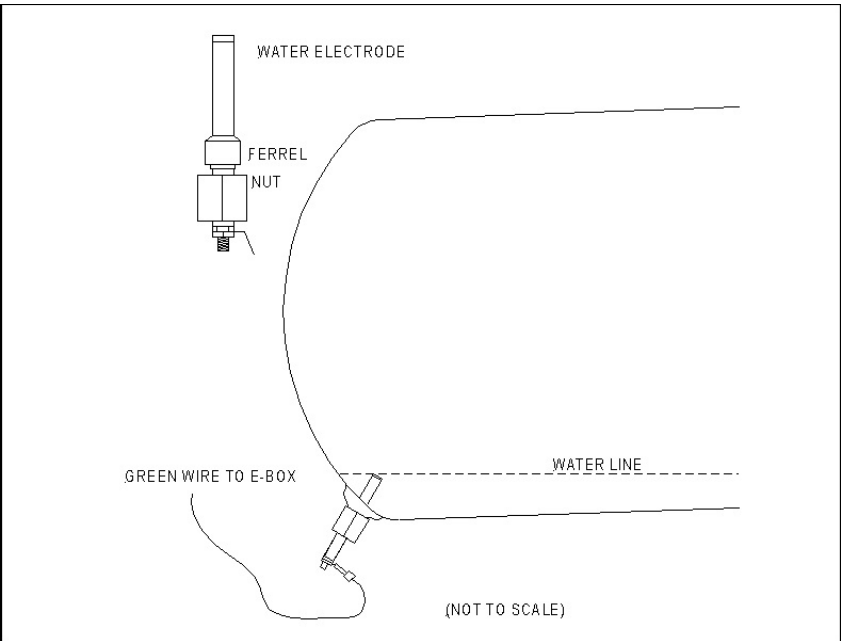

13 Troubleshooting

Only technical personnel having proper qualifications and holding technical documentation (including a technician manual) and adequate information are authorized to service the apparatus.

Problem/ Error Message	Message / Symbol Description	Corrective Action
Display is not activated	<ul style="list-style-type: none"> The main switch is in the 'off' position. the power cord is not connected properly to the machine and the power source. There is no electrical power in the main source. 	<ul style="list-style-type: none"> Turn the main switch on. Make sure the power cord is properly connected to the machine and the power source. Fix the electrical power supply.
The printer does not print	<ul style="list-style-type: none"> The paper is not inserted correctly in the printer. 	<ul style="list-style-type: none"> Make sure the paper is inserted in the printer correctly. See sec. 8.2. Switch the machine off then back on. If the printer prints the date and time, the printer is O.K.
Low Vacuum' is displayed	Message is displayed and FAIL indicator lights if in the air removal stage a vacuum level of 25kPa is not reached during 20 minutes after the cycle is started.	Perform a new cycle. Call for service.
"Analog Input Error"	This message is displayed when any Temperature sensor or Pressure sensor is disconnected or out of range.	Call for service.
"Chamber temperature not in range"	This message is displayed if the temperature in the chamber is too high or too low from the normal range.	Wait until the the chamber reaches the normal range temperature.
"Chamber pressure not in range"	This message is displayed if the pressure in the chamber is too high or too low from the normal range.	Wait until the the chamber reaches the normal range pressure.
"I/O Card Failed"	This message is displayed if I/O card is faulty (both while cycle is running or not).	Call for service.
"I/O card is not connected"	This message is displayed if I/O card is disconnected (both while cycle is running or not).	Call for service.

Problem/ Error Message	Message / Symbol Description	Corrective Action
"Low Temp"	This message is displayed if the temperature drops for more than 1 second below the sterilization temperature during sterilization cycle.	Perform a new cycle.
"High Temp"	This message is displayed if the temperature raises 7°F (4°C) above sterilization temperature during the sterilization stage for 2 seconds during sterilization cycle.	Perform a new cycle.
"High Temp. (Ending)"	This message is displayed if the system cannot reach the required temperature, in the chamber, within 10 minutes.	Perform a new cycle.
"Heat Time Error"	This message is displayed if the system cannot reach the required temperature, in the chamber, within the preset time.	Verify that the autoclave is not overloaded.
"Heat Time Error (Keep)"	This message is displayed if the system cannot reach the required temperature, in the chamber, during the optional "Keep Heat" stage, within the preset time.	Verify that the autoclave is not overloaded.
"Low Pressure"	This message is displayed if Chamber Pressure drops below the sterilization pressure (135°C = 313 kPa , 134°C = 304 kPa , 132°C = 286 kPa 121°C = 205 kPa) for 2 seconds during the sterilization stage.	Perform a new cycle.
"High Pressure"	This message is displayed if Chamber Pressure raises 4.2 psi-29 kPa above sterilization pressure (135°C = 313 kPa , 134°C = 304 kPa , 132°C = 286 kPa 121°C = 205 kPa) for 2 seconds during the sterilization stage.	Perform a new cycle.
"High Pressure (Ending)"	This message is displayed if the system cannot reach atmospheric pressure \pm 5kPa during the ending stage.	Perform a new cycle.
"Pressure Time Error"	This message is displayed if the system cannot reach the required pressure conditions in the chamber, after preset time, during the air removal stage.	Verify that the autoclave is not overloaded.
"RTC Error - Please Set Current Date and Time"	This message is displayed in order to set the date and the time.	Set Current Date And Time. If the problem persists, call for service.

Problem/ Error Message	Message / Symbol Description	Corrective Action
"Time Error"	This message is displayed if the real time clock is faulty.	Call for service.
"Door is open (During the cycle)"	This message is displayed when the door is open: During the cycle.	Close the door to perform a new cycle.
"Canceled By User"	This message is displayed after the START/STOP key is pressed and cycle aborted.	Wait until "cycle failed – canceled by user" or "cycle end – canceled by user" is displayed. Perform a new cycle.
 "Cycle Failed"	This message and symbol are displayed if an error occurs before sterilization cycle is completed.	Perform a new cycle.
"Air Error"	This message is displayed at the end of the cycle If the autoclave does not reach the atmospheric pressure after 10 minutes.	Wait until the autoclave reaches the atmospheric pressure and perform a new cycle.
"Periodical check time exceeded - Please call for service"	The periodical maintenance time has passed.	Call for service.
"Mineral free water reservoir empty"	This message is displayed if the water level electrode does not sense water.	Fill the mineral free water reservoir.
"Cycle counter exceeded - Please call for service"	Number of cycles, since last periodical maintenance, exceeded the preset number as defined by "cycle counter" parameter.	Call for service.
"Power Down"	This message is displayed if power down has occurred during the cycle. (this message will print out in the printer after the autoclave turns on).	Turn on the autoclave and wait until the autoclave is ready (reaches the safe condition) and perform a new cycle.
"No Water"	This message is displayed if the electrode in the chamber did not sense water within the preset time.	1. check and fix the mineral free water supply. 2. check and clean the water inlet filter. 3. Clean the water level electrode.

14 Baskets and Containers



Basket

Container for waste products

Stainless steel wire baskets		Stainless steel container for waste products	
L x D x H (mm)	Capacity	L x D x H (mm)	Capacity
400 x 180 x 160	1	400 x 190 x 160	1

14.1 Pouch Rack ACS215-0008

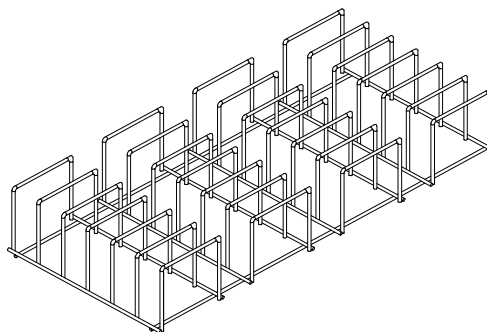

15 Spare Parts List

Part number	Description
FIL175-0042	Filter, Air, 0.2 Micron, Model 50mm D
THE002-0066	Thermal paper for CUSTOM PLUSII printer roll 57mm, d=50mm

16 Accessories

Part number	Description
GAS084-0007	Drain P.V.C. Tube, 8x12
THE002-0052	Printer, PLUSII-S2B-0004
WIR040-0002	Cable, Electric, Plug + Socket /230V 10A, EUR